



Olimex PIC-KIT3
In-circuit programmer/debugger

USER'S MANUAL

Revision D, February 2018



All boards produced by Olimex LTD are ROHS compliant

DISCLAIMER

© 2017 Olimex Ltd. Olimex®, logo and combinations thereof, are registered trademarks of Olimex Ltd. Other product names may be trademarks of others and the rights belong to their respective owners.

The information in this document is provided in connection with Olimex products. No license, express or implied or otherwise, to any intellectual property right is granted by this document or in connection with the sale of Olimex products.

The hardware and the software files are closed source and would not be distributed nor shared.

It is possible that the pictures in this manual differ from the latest revision of the board.

The product described in this document is subject to continuous development and improvements. All particulars of the product and its use contained in this document are given by OLIMEX in good faith. However all warranties implied or expressed including but not limited to implied warranties of merchantability or fitness for purpose are excluded. This document is intended only to assist the reader in the use of the product. OLIMEX Ltd. shall not be liable for any loss or damage arising from the use of any information in this document or any error or omission in such information or any incorrect use of the product.

This product is intended for use for engineering development, demonstration, or evaluation purposes only and is not considered by OLIMEX to be a finished end-product fit for general consumer use. Persons handling the product must have electronics training and observe good engineering practice standards. As such, the goods being provided are not intended to be complete in terms of required design-, marketing-, and/or manufacturing-related protective considerations, including product safety and environmental measures typically found in end products that incorporate such semiconductor components or circuit boards.

Olimex currently deals with a variety of customers for products, and therefore our arrangement with the user is not exclusive. Olimex assumes no liability for applications assistance, customer product design, software performance, or infringement of patents or services described herein.

THERE IS NO WARRANTY FOR THE DESIGN MATERIALS AND THE COMPONENTS USED TO CREATE PIC-KIT3. THEY ARE CONSIDERED SUITABLE ONLY FOR PIC-KIT3.

Table of Contents

<u>DISCLAIMER.....</u>	<u>2</u>
<u>CHAPTER 1: OVERVIEW.....</u>	<u>4</u>
<u>1. Introduction to the chapter.....</u>	<u>4</u>
<u>1.1 Features.....</u>	<u>4</u>
<u>1.2 Target market and purpose of the board.....</u>	<u>4</u>
<u>1.3 Comparison of Olimex PIC-KIT3 and Microchip PICKit3.....</u>	<u>5</u>
<u>1.4 Organization.....</u>	<u>5</u>
<u>CHAPTER 2: DEVICE DESCRIPTION.....</u>	<u>6</u>
<u>2. Introduction to the chapter.....</u>	<u>6</u>
<u>2.1 Ports and connectors.....</u>	<u>6</u>
<u>2.1.1 USB Standard-B connector.....</u>	<u>6</u>
<u>2.1.2 ICSP connector.....</u>	<u>6</u>
<u>2.1.3 Power jack.....</u>	<u>7</u>
<u>2.2 Status LEDs.....</u>	<u>7</u>
<u>2.3 Programmer-to-go button.....</u>	<u>7</u>
<u>2.3.1 Programmer-to-go in MPLAB 8.....</u>	<u>8</u>
<u>2.3.2 Programmer-to-go in MPLAB X.....</u>	<u>8</u>
<u>CHAPTER 3: SETTING UP PIC-KIT3.....</u>	<u>9</u>
<u>3. Introduction to the chapter.....</u>	<u>9</u>
<u>3.1 Hardware setup.....</u>	<u>9</u>
<u>3.2 MPLAB 8.....</u>	<u>9</u>
<u>3.3 MPLAB X.....</u>	<u>10</u>
<u>CHAPTER 4: FREQUENTLY ASKED QUESTIONS.....</u>	<u>12</u>
<u>CHAPTER 5: REVISION HISTORY AND SUPPORT.....</u>	<u>14</u>
<u>5. Introduction to the chapter.....</u>	<u>14</u>
<u>5.1 Document revision.....</u>	<u>14</u>
<u>5.2 Useful web links and purchase codes.....</u>	<u>14</u>
<u>5.3 Product support.....</u>	<u>15</u>

CHAPTER 1: OVERVIEW

1. Introduction to the chapter

Thank you for choosing the PIC-KIT3 programmer/debugger manufactured by Olimex LTD. The first chapter focuses on the overview of the product.

1.1 Features

Features of Olimex PIC-KIT3:

- USB (Full-Speed 2 Mbits/s) interface to host PC
- Real-time background debugging
- Supported in MPLAB X, MPLAB IPE and MPLAB 8
- Built-in over-voltage/short circuit monitor
- Firmware upgradeable from PC
- Supports low voltage down to 2.0 volts. (2.0 to 6.0 range)
- Diagnostic bi-color LED (Busy, Error)
- External power jack (6-9)VDC for standalone programming
- Reading/writing memory space and EEDATA areas of target microcontroller
- Programs configuration bits
- Erase of program memory space with verification
- Peripheral freeze-on-halt stops timers at breakpoints

1.2 Target market and purpose of the board

The PIC-KIT3 is a programmer/debugger that is controlled by a PC via MPLAB or MPLAB X IDE under Windows OS. The PIC-KIT3 programmer/debugger is used for hardware and software development of Microchip PIC microcontrollers (MCUs) and dsPIC Digital Signal Controllers (DSCs) that are based on In-Circuit Serial Programming (ICSP) and Enhanced In-Circuit Serial Programming 2-wire serial interfaces.

A programmer/debugger is an inseparable part of an active development process that involves PIC microcontrollers.

The PIC-KIT3 is considered superior to PIC-ICD2-POCKET and has better support for newer versions of MPLAB.

1.3 Comparison of Olimex PIC-KIT3 and Microchip PICKit3

There are several differences between the Olimex PIC-KIT3 and the original Microchip PICKit3. Most of them are purely design choices and bring no functional differences. The main differences are listed in the table below:

	Olimex PIC-KIT3	Microchip PICKit3
Device <-> PC cable interfaces	USB type B <-> USB type A	USB mini <-> USB type A
Device <-> PC cable included	No	Yes
Indicator LEDs	2 (yellow, red/green)	3 (green, blue, yellow)
ICSP connector	Male, mirrored cable included	Female, straight cable not included
Power jack for stand-alone programming	Yes	No

The Olimex PIC-KIT3 has additional power jack which comes handy in field programming situations.

1.4 Organization

Each section in this document covers a separate topic, organized as follow:

- Chapter 1 is an overview of the board usage and features
- Chapter 2 provides information about the connectors and the status LEDs
- Chapter 3 provides a guide for quickly setting up the board and the needed software
- Chapter 4 is a frequently asked questions section
- Chapter 5 features a set of useful links, warranty info and purchase locations

CHAPTER 2: DEVICE DESCRIPTION

2. Introduction to the chapter

This chapter features explanation of the interfaces visible to the user. Most of the time those would be the only parts of the PIC-KIT3 that the user manipulates or contact with.

2.1 Ports and connectors

The user can freely access the USB and the ICSP connectors available. There is also a power jack near the USB. The pinouts and the usage of those are discussed below.

2.1.1 USB Standard-B connector

The USB type B connector follows the USB 2.0 specification. The connector itself looks like this:



2.1.2 ICSP connector

The pinout of the ICSP connector (note that the cable after it might change the signals) is shown below below:

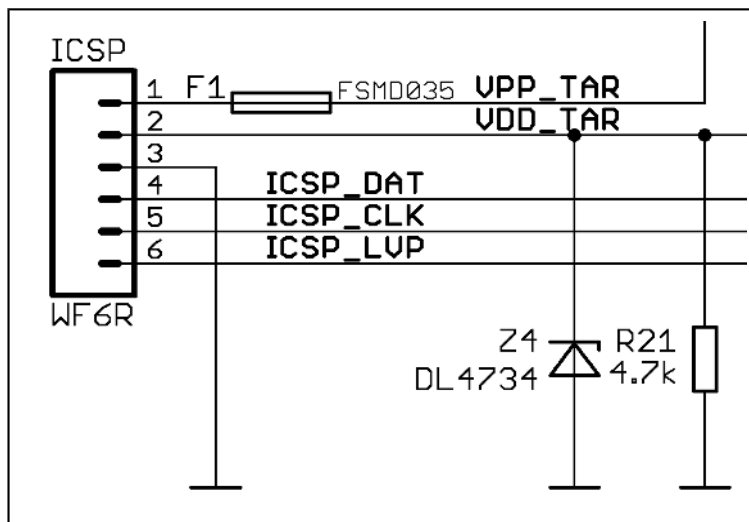

2.1.3 Power jack

The Olimex PIC-KIT3 has additional power jack which comes handy in field programming situations where you lack mini USB cable, but you have access to external power.

The power jack should receive between (6-9)V DC and it is practical to already have an image uploaded in the PIC-KIT3 before using the power jack.

The inner pin is the VDC, the outer plate is the GND.

Please notice that previous hardware revisions of Olimex PIC-KIT3 allowed up to 12V DC applied to the power jack, however this is NO LONGER the case. Applying 12V DC to the power jack would damage PIC-KIT3!

2.2 Status LEDs

PIC-KIT3 has two LEDs – yellow one named ACTIVE and a double-color (red/green) one named STAT.

The yellow LED shows USB activity – e.g. when the device is connected to the USB properly; when you are powering the board from external source via the power jack this LED would blink. The STAT LED shows RED color when you are connected to MPLAB or the image inside the flash memory is ready for operation. When there is programming data transferred the double LED should blink in orange color (red and green).

2.3 Programmer-to-go button

The button allows you to program a device with a single button press with a binary image stored in the internal flash memory of PIC-KIT3. Storing the image inside is done via MPLAB.

The small black button near the USB Standard-B connector is used to program target devices with the binary image stored in the 512k Flash. This function works fine together with the power jack which allows easy operation when a power supply is available nearby without the need of a computer or USB power supply.

The programmer-to-go button is also used to enter bootloader mode. You would never need to use bootloader mode, when the unit is operating as expected. However, the bootloader mode might come in handy for firmware recovery. To enter bootloader mode:

1. Disconnect PIC-KIT3 from the USB cable.
2. Press and hold down “programmer-to-go” button.
3. Connect PIC-KIT3 to the USB cable.
4. Release “programmer-to-go” button.

Note! There is a bug when using programmer-to-go button without an image stored in the PIC-KIT3 flash memory. This bug might occur if using a PIC32 target chip which might leave it in unrecoverable state. It is advisable to always ensure there is an image in the PIC-KIT3 (from MPLAB interface). Be especially careful with the button when handling PIC32 targets.

2.3.1 Programmer-to-go in MPLAB 8

Once you connect the device as explained in CHAPTER 3 (respectively for MPLAB 8), and you have selected the “PICKit 3” in programmer menu, go to “Settings”. Click on the Programmer-to-go tab and “Send Image in Memory”. You need to have a ready image either by importing a binary (hex), reading such from the target device or by building the current project.

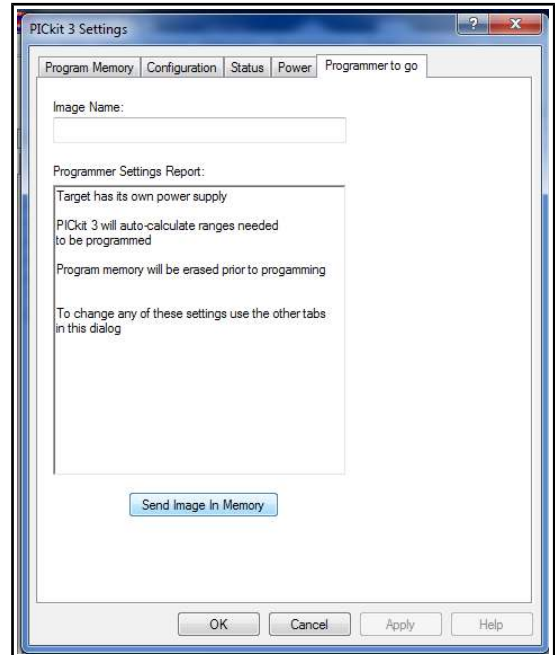
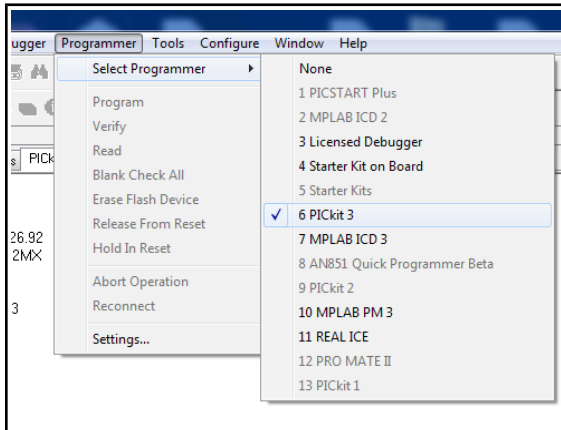

2.3.2 Programmer-to-go in MPLAB X

First make a standard project or import binary file using the recommended settings.

Then you have to add the 'Programmer To Go PICKit3 Main Project' button to the debugger toolbar. You can do this by right-clicking on any empty toolbar space (up at the top of the IDE). A popup menu will appear. Choose the Customize menu item to get the Customize Toolbars dialog. Scroll down to the Project folder and select the first icon there (the Programmer To Go PICKit3 Main Project icon). Drag it to the debug tool bar (the one with the green run arrow). Close the menu. Finally, press this button and it will invoke the programmer-to-go feature.

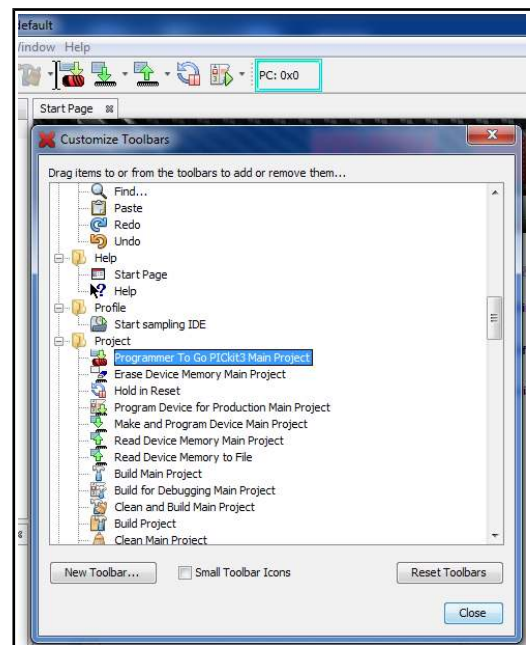

CHAPTER 3: SETTING UP PIC-KIT3

3. Introduction to the chapter

More details about the standard connection routine of Olimex PIC-KIT3 and your target via MPLAB 8 and MPLAB X.

3.1 Hardware setup

The required hardware for successful connection might vary depending on the target board and chip.

PIC-KIT3 has a 6-pin male DIP header with 2.54mm (0.01") pitch.

1) The first thing to consider is the target's connector's type. Some of the older boards have RJ11 connector. Some boards have connectors with smaller step (0.05" distance between pins). For cases like that an adapter might be created following the pinout. Alternatively, we sell adapter for cases like this named PIC-ICSP: <https://www.olimex.com/Products/PIC/Programmers/PIC-ICSP/>.

If not using an already assembled board, please, refer the pinout of the connector of the debugger in CHAPTER 2. Note the mirrored female-female ICSP cable that ships with the programmer/debugger.

2) After the connection between the OLIMEX PIC-KIT3 and your target board is established you need to connect the debugger to the computer. Note that this requires a USB standard-B to USB standard-A cable which is not included in the package but might be purchased separately either from your favorite electronics store or from our web site.

3) The final hardware note is to power the target chip/board. The PIC-KIT3 allows target powering in the (3.0-3.5)VDC range with the standard amperage for USB 2.0 – 100mA maximum. If you board exceeds these power requirements make sure it is sufficiently powered.

3.2 MPLAB 8

Connecting the programmer/debugger in MPLAB 8.xx is fairly straightforward but it is recommended to be done in the following order:

1. Start MPLAB 8.xx
2. Select target chip from “Configure” → “Select Device”. Ensure the device selected is supported by PIC-KIT3. If there is a green dot at the left side of PIC-KIT3 it is supported.
3. Select PIC-KIT3 either as a programmer (or a debugger) from “Programmer” → “Select programmer” (or “Debugger” → “Select tool”)

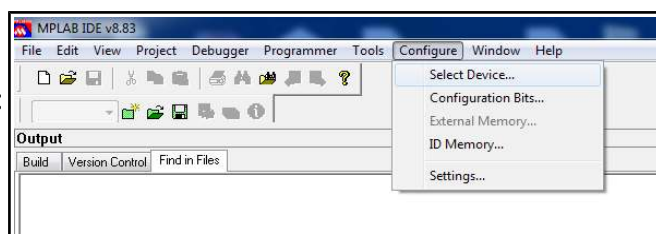

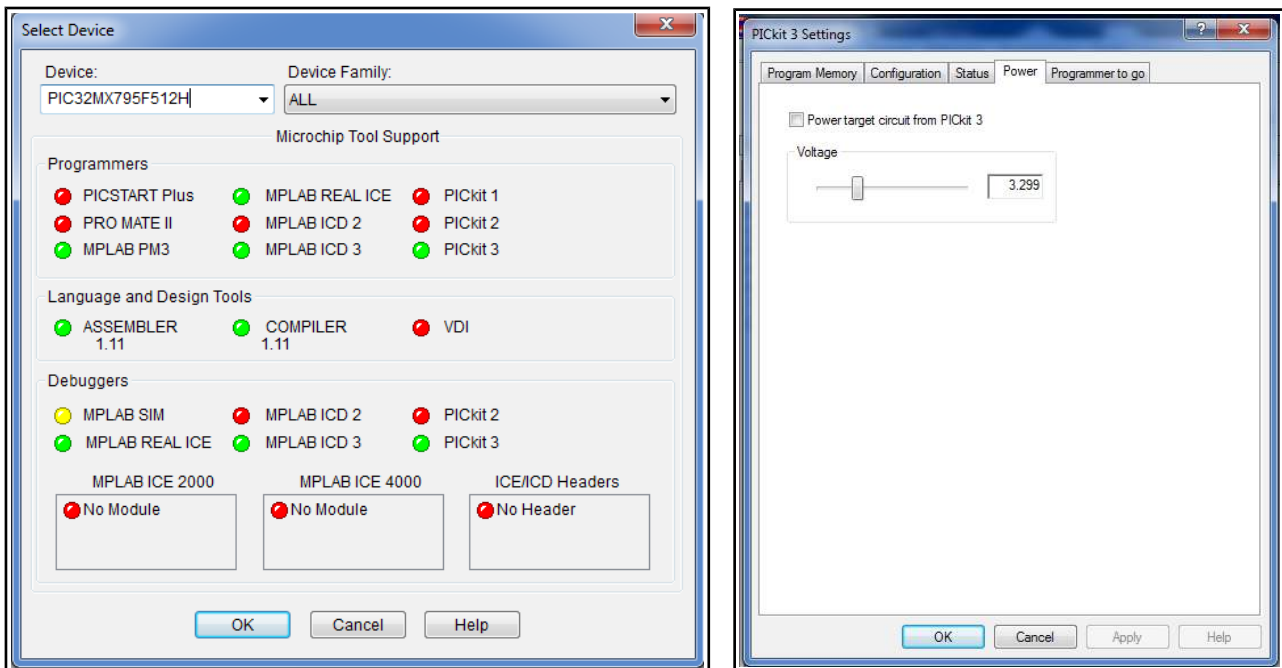

(optional) 4. If asked for firmware update – allow it to download and do not disconnect while the device is updating

(optional) 5. If you wish (and it is possible) you can power your target board/MCU via the PIC-KIT3 from Programmer Settings Power Choose desired voltage and check the box.

6. Note! Before unplugging PIC-KIT from the computer, disconnect it from the MPLAB IDE by navigating to “Programmer” → “Select programmer” (or “Debugger” → “Select tool”) and then selecting “None”

7. You are now ready to start a new project, import a binary or debug existing project via the PIC-KIT3.

Refer to the documentation available at Microchip's web site for more information on the MPLAB.

3.3 MPLAB X

1. Create a project or import a hex – a dialog window appears.
2. Choose the correct device and mark the PICKit3 as a hardware tool (if you miss that step when the project is ready or you have opened a ready project – right-click over the project and go to settings)

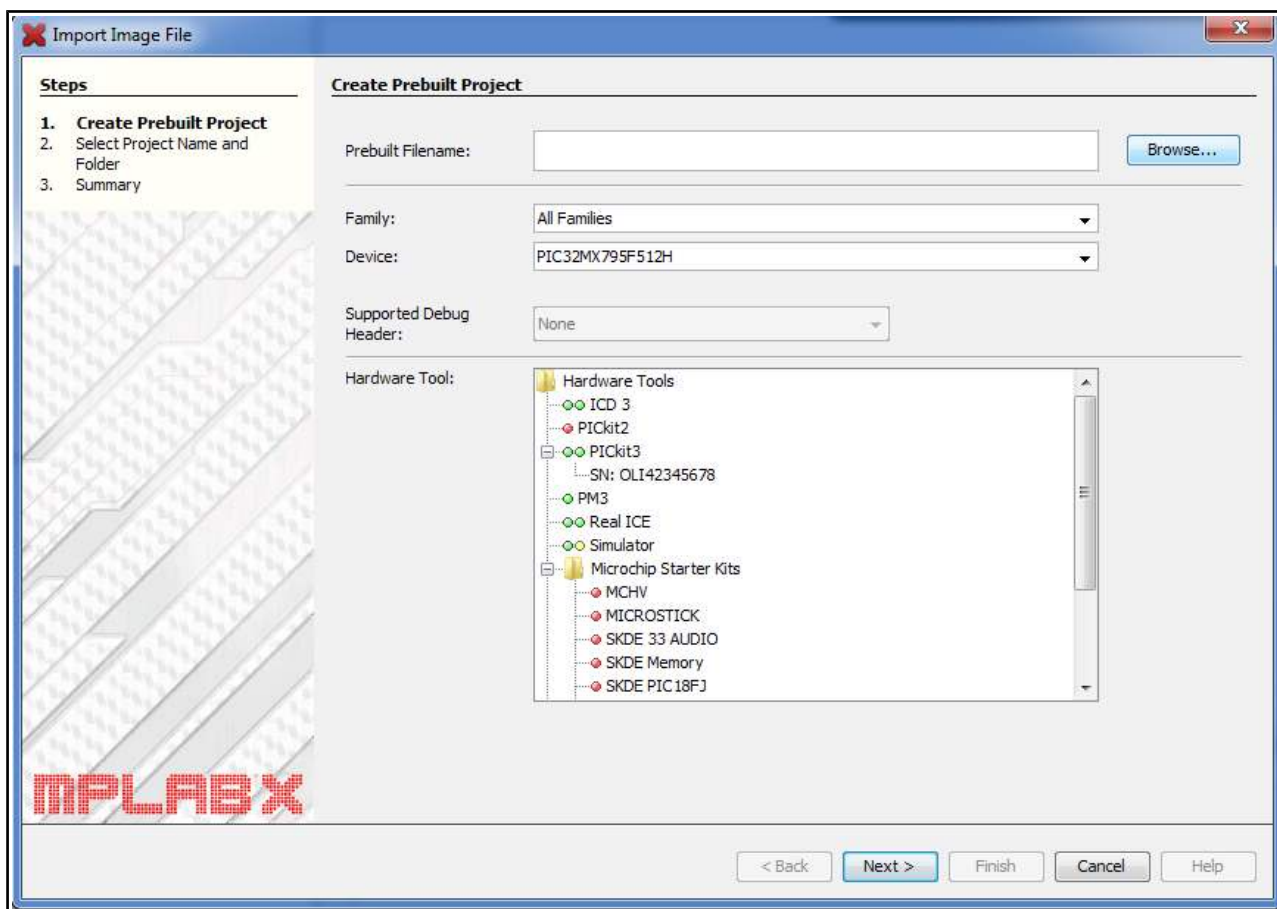

3. Click Next → adjust destination folders and names

4. Click Next → review the information and choose to Finish

(optional) 5. After the project is ready you adjust options by selecting and right-clicking over the project name and going to the “Properties” option. Mark the PICKit3 entry and take a look at the different drop-down options. You can set the power to the target board from there also.

CHAPTER 4: FREQUENTLY ASKED QUESTIONS

Q: What USB cable do I need?

A: You should have a USB type A-B cable to connect to PC, all PC USB hosts have USB-A connector while PIC-KIT3 has USB-B connector so the cable should be USB A-to-B type. Note that such a cable is not included in the package.

Q: Does your ICSP connector layout differ from the ICSP connector layout of the original PIC-KIT3?

A: Yes. This can be easily adjusted by proper mirrored cable. Pay attention to the mirroring of the cables that the Olimex PIC-KIT3 comes with. Note the layout at the connector also.

Q: What should I know when I connect PIC-KIT3 to a target board?

A: It's very important that your target PIC MCLR is not connected directly to VCC! During the programming/debugging MCLR goes as high as 13VDC and if your target MCLR is connected directly to the target's VCC you will blow either the PIC-KIT3 or your target board. Always use 10K pull-up resistor from MCLR to VCC.

Q: What are the LEDs for?

A: There are two LEDs – one yellow LED named ACTIVE and one double-color (red/green) LED named STAT. The yellow LED shows USB activity, e.g. when the device is connected to the USB properly; when you are powering the board from external source via the power jack this LED would blink. The STAT LED shows RED color when you are connected to MPLAB or the image inside the flash memory is ready for operation. When there is programming data transferred the double LED should blink in orange color (red and green).

Q: What voltage should I provide to the power jack for “programmer-to-go” stand alone mode?

A: (6-9) V DC; the inner pin of the connector is the DC

Q: Hello, I pressed the "programmer-to-go" button and my PIC32 died. What burned my chip?

A: Do not use "programmer-to-go" button when there is **no image** in the OLIMEX PIC-KIT3 or MICROCHIP PIC-KIT3 or that might put your microcontroller in an unrecoverable state. We have tested the mentioned scenario and we can confirm it destroys PIC32 chips (using both our and the original Microchip PICKIT3). We don't take responsibility if you brick your chip that way.

Q: Hello, I attempted to use PIC-KIT3 and then the connection failed. After this the PIC-KIT3 gets listed with exclamation mark in "Windows Device Manager" and reports the error - "This device cannot start. (Code 10)". What is the problem? What should I do?

A: This problem might appear after a failed firmware update. The firmware update might fail due to different reasons. It happens more frequently when you often change the versions of MPLAB that you use (the latest PIC-KIT3 firmware versions in MPLAB 8 differ a lot from the latest PIC-KIT3 firmware versions in MPLAB X or MPLAB IPE).

There is a fix for this problem – enter bootloader mode – disconnect the PIC-KIT3 from the USB; press and hold the small black button (programmer-to-go button); connect the PIC-KIT3 to the USB; release the button. Then open MPLAB or MPLAB IPE and attempt the connection again. Make sure you are using latest version of MPLAB IDE or MPLAB IPE.

If the connection still fails re-try the procedure at least few more times. Then try to manually download the firmware (again enter bootloader mode using the button) and then go to "Settings" -> "Manual Download Firmware". In MPLAB IPE you would need first enable "Advanced Mode" before being able to select "Manual Download Firmware".

Test the same procedure (to manually download the firmware) without entering bootloader mode – use a standard connect procedure (do not hold the button).

Finally, test the above fixes with another MPLAB version. For example, if you have used MPLAB 8, try with the latest MPLAB IPE; or if you have used MPLAB IPE, then try with MPLAB 8.92.

Sometimes closing-opening the software would allow you to perform the firmware update. Sometimes you would need to try a few times until it succeeds.

Q: Hello, I use both MPLABX and MPLAB 8.xx. Recently, the "programmer-to-go" to go function stopped working in MPLAB 8, everything else works fine. The error I get is: "PK3Err0033: 4 bytes expected, 0 bytes received". What can I do?

A: This is a known problem that affects both the original Microchip PICKit3 and Olimex PIC-KIT3. It was caused by the newest firmware released. Most typically the problem appears after you have used new version of MPLAB X or MPLAB IPE. You PIC-KIT3 got automatically upgraded with a firmware version that is no longer compatible with MPLAB 8. The versions incompatible with MPLAB 8 are firmware versions 1.3x.xx and newer (1.35.16, for example). With such a firmware you will not be able to make proper connections to targets after an AP update nor you would be able to use programmer-to-go in any MPLAB prior of MPLAB X. The PIC-KIT3 would still work fine in MPLABX and MPLAB IPE (and the programmer-to-go would also work fine).

So if you want to use MPLAB 8 you would need to manually revert to firmware version 1.28.90 (or any 1.2x.xx version). This can be done in MPLAB 8:

1. Navigate to Programmer -> Select Programmer -> PICKit3
2. Deal with any pop up message making sure there is some power to the PIC-KIT3; ignore any reports for errors they doesn't matter at this point
3. Navigate to "Programmer" -> "Settings" (at the bottom); click "Configuration" tab; Disable "Auto Download Latest Firmware" and click "Manual Download". Point the pop-up to PK3FW_012890.jam (or similar as long as it is located in the MPLAB 8 folders), by default located in C:\Program Files (x86)\Microchip\MPLAB IDE\PICKit 3. Click "OK" and wait for upload.
4. If there are problems or the update takes more than a few minutes disconnect the PIC-KIT3 from the USB, connect it again and try the firmware update again. The procedure would refuse to work sometimes if you don't reset the connection (by unplugging and plugging the PIC-KIT3 again).
5. Upon successful revert you would see "Firmware Suite Version..... 01.28.90" instead of "Firmware Suite Version..... 01.35.16".

Now you can use MPLAB 8 as previously and the programmer-to-go button would work.

Q: My PIC16 can not be debugged. Why?

A: Some PIC MCUs might require additional headers to be able to debug them. Always check the chip's datasheet for hardware requirements.

CHAPTER 5: REVISION HISTORY AND SUPPORT

5. Introduction to the chapter

In this chapter you will find the current and the previous version of the document you are reading. Also the web-page for your device is listed. Be sure to check it after a purchase for the latest available updates and examples.

5.1 Document revision

Revision	Changes	Modified Page#
A, 28.01.13	Initial release	All
B, 29.10.13	Swapped wrong picture about the ICSP connector. Added additional FAQ about the ICSP orientation.	6 12
C, 02.10.15	Added additional FAQ about frequent firmware change problems	12, 13
D, 06.02.18	Edited information about the maximum input voltage for the power jack. The power jack requires between 6V and 9V DC; more than 9V DC are no longer supported by the hardware	All pages that mention the power jack voltage.

5.2 Useful web links and purchase codes

A place for general questions, FAQ or friendly talk check our forums:

<https://www.olimex.com/forum/>

PIC-KIT3 – <https://www.olimex.com/Products/PIC/Programmers/PIC-KIT3/>

PIC-ICSP – <https://www.olimex.com/Products/PIC/Programmers/PIC-ICSP/>

USB-A-B-CABLE – <https://www.olimex.com/Products/Components/Cables/USB-A-B-CABLE/>

How to purchase?

You can purchase directly from our online shop or from any of our distributors. List of distributors:

<https://www.olimex.com/Distributors>.

Check <https://www.olimex.com/> for more info.

5.3 Product support

For product support, hardware information and error reports mail to: support@olimex.com. Note that we are primarily a hardware company and our software support is limited.

Please consider reading the paragraph below about the warranty of Olimex products.

Warranty and returns:

Our boards have lifetime warranty against manufacturing defects and components.

During development work it is not unlikely that you can burn your programmer or development board. This is normal, we also do development work and we have damaged A LOT of programmers and boards during our daily job so we know how it works. If our board/programmer has worked fine then stopped, please check if you didn't apply over voltage by mistake, or shorted something in your target board where the programmer was connected etc. Sometimes boards might get damaged by ESD shock voltage or if you spill coffee on them during your work when they are powered.

Please note that warranty do not cover problems caused by improper use, shorts, over-voltages, ESD shock etc.

If the board has warranty label it should be not broken. Broken labels void the warranty, same applies for boards modified by the customer, for instance soldering additional components or removing components - such boards will be not be a subject of our warranty.

If you are positive that the problem is due to manufacturing defect or component you can return the board back to us for inspection.

When we receive the board we will check and if the problem is caused due to our fault and we will repair/replace the faulty hardware free of charge, otherwise we can quote price of the repair.

Note that all shipping back and forth have to be covered by the customer. Before you ship anything back you need to ask for RMA. When you ship back please attach to it your shipping address, phone, e-mail, RMA# and brief description of the problem. All boards should be sent back in antistatic package and well packed to prevent damages during the transport.