

## Double valve connector adapter - SAC-MR/0,1-116/2XB-1L-Z SCO - 1458318

Please be informed that the data shown in this PDF Document is generated from our Online Catalog. Please find the complete data in the user's documentation. Our General Terms of Use for Downloads are valid (<http://download.phoenixcontact.com>)



Double valve connector adapter, npn, 4-position, PUR, Black RAL 9005, Plug angled M12 SPEEDCON, A-coded, on Valve connector B (10 mm), with 1 LED, connected with Z diode and Valve connector B (10 mm), with 1 LED, connected with Z diode, Valve connector distance: 0.1 m

### Product Features

- ✓ Easy and safe: 100% electrically tested plug-in components
- ✓ Robust valve connector with Zener diode as protective circuit
- ✓ Efficient: control valves with two connections via a single connecting cable
- ✓ Convenient: increased machine availability thanks to quick and easy diagnostics



### Key commercial data

Packing unit	1 1
Custom tariff number	85444290
Country of origin	Germany

### Technical data

#### Dimensions

Valve connector distance	0.1 m
--------------------------	-------

#### Ambient conditions

Ambient temperature (operation)	-25 °C ... 85 °C (valve plug)
Degree of protection	IP65
	IP67

#### General

Rated current at 40°C	4 A
Rated voltage	24 V AC/DC
Number of positions	4

# Double valve connector adapter - SAC-MR/0,1-116/2XB-1L-Z SCO - 1458318

## Technical data

### General

Contact resistance	≤ 5 mΩ
Insulation resistance	≥ 100 MΩ
Coding	A - standard
Standards/regulations	M12 connector IEC 61076-2-101
	Valve connector EN 175301-803
Signal type/category	npn
Status display	1 LED
Protective circuit/component	Z diode
Surge voltage category	II
Pollution degree	3
Insertion/withdrawal cycles	50 (valve plug)
Torque	0.6 Nm (valve plug)

### Material

Inflammability class according to UL 94	HB
Contact material	CuSn
Contact surface material	Ni/Au
Contact carrier material	PA 66
Valve plug contact material	CuSn
Valve plug contact surface material	Sn
Valve plug contact insert material	PA 66
Material housing valve plug	TPU
Material, knurls	Zinc die-cast, nickel-plated
Sealing material	TPU (Seal molded)

### Cable

Cable type	PUR/PVC, 0.75 mm <sup>2</sup> , black
Cable type (abbreviation)	116
Cable abbreviation	LiYY11Y
UL AWM style	20549
Conductor cross section	3x 0.75 mm <sup>2</sup> (signal line)
AWG signal line	18
Conductor structure signal line	24x 0.20 mm
Core diameter including insulation	1.7 mm ±0.05 mm
Wire colors	Black 1, black 2, green/yellow
Overall twist	3 wires, twisted
External sheath, color	Black RAL 9005

# Double valve connector adapter - SAC-MR/0,1-116/2XB-1L-Z SCO - 1458318

## Technical data

### Cable

External cable diameter	5.80 mm
Smallest bending radius, fixed installation	58 mm
Number of bending cycles	1000000
Bending radius	58 mm
Traversing path	10 m
Traversing rate	2 m/s
Acceleration	2.5 m/s <sup>2</sup>
Outer sheath, material	PUR
Material, inner sheath	PVC
Material conductor insulation	PVC
Conductor material	Bare Cu litz wires
Insulation resistance	≥ 20 MΩ*km
Conductor resistance	26 Ω/km (at 20 °C)
Nominal voltage, cable	300 V
Test voltage, cable	1200 V
Special properties	Flexible cable conduit capable
	Silicone-free
	Free of substances which would hinder coating with paint or varnish
Flame resistance	DIN VDE 0482
	DIN EN 50265-2-1
	In accordance with UL FT-2
Other resistance	Highly resistant to acids, alkaline solutions and solvents
	hydrolysis and microbe resistant
Ambient temperature (operation)	-40 °C ... 80 °C (cable, fixed installation)
	-5 °C ... 80 °C (cable, flexible installation)

## Classifications

### eCl@ss

eCl@ss 4.0	27060306
eCl@ss 4.1	27060306
eCl@ss 5.0	27061801
eCl@ss 5.1	27061801
eCl@ss 6.0	27279218
eCl@ss 7.0	27279218
eCl@ss 8.0	27279218

# Double valve connector adapter - SAC-MR/0,1-116/2XB-1L-Z SCO - 1458318

## Classifications

### ETIM

ETIM 4.0	EC001855
ETIM 5.0	EC001855

### UNSPSC

UNSPSC 6.01	31251501
UNSPSC 7.0901	31251501
UNSPSC 11	31251501
UNSPSC 12.01	31251501
UNSPSC 13.2	31251501

## Accessories

### Accessories

#### Conductor marking

Insert label - PABA WH/15 - 1013151



Insert label, Strip, white, Unlabeled, Can be labeled with: Plotter, Mounting type: Thread on, Cable diameter: 0.6-50 mm, Lettering field: 15 x 4 mm

Insert label - PABA YE/15 - 1013698



Insert label, Strip, yellow, Unlabeled, Can be labeled with: Plotter, Mounting type: Thread on, Cable diameter: 0.6-50 mm, Lettering field: 15 x 4 mm

Insert label - PABA RD/15 - 1013944



Insert label, Strip, red, Unlabeled, Can be labeled with: Plotter, Mounting type: Thread on, Cable diameter: 0.6-50 mm, Lettering field: 15 x 4 mm

## Double valve connector adapter - SAC-MR/0,1-116/2XB-1L-Z SCO - 1458318

### Accessories

#### Marker carrier cable

##### Conductor marker carrier - PATO 2/15 - 1013122



Conductor marker carrier, transparent, Unlabeled, Mounting type: Clip on, Cable diameter: 2.8-4.4 mm, Lettering field: 4 x 15 mm

---

##### Conductor marker carrier - PATO 3/15 - 1013135



Conductor marker carrier, transparent, Unlabeled, Mounting type: Clip on, Cable diameter: 4.4-6.7 mm, Lettering field: 4 x 15 mm

---

##### Conductor marker carrier - PATO 4/15 - 1013148



Conductor marker carrier, transparent, Unlabeled, Mounting type: Clip on, Cable diameter: 6.7-10 mm, Lettering field: 4 x 15 mm

---

#### Marker pen

##### Marker pen - B-STIFT - 1051993



Marker pen, for manual labeling of unprinted Zack strips, smear-proof and waterproof, line thickness 0.5 mm

---

#### Screwdriver tools

# Double valve connector adapter - SAC-MR/0,1-116/2XB-1L-Z SCO - 1458318

## Accessories

Screw insert - SF-BIT-PH 1-70 - 1212582



Screw bit, PH crosshead, E6.3-1/4" drive, size: PH 1 x 70 mm, hardened, suitable for holder according to DIN 3126-F6.3/ISO 1173

---

## Torque tool

Torque screwdriver - TSD-M 1,2NM - 1212224



Torque screw driver, accuracy as per EN ISO 6789 standard, adjustable from 0.3 - 1.2 Nm

---

## Drawings

Schematic diagram

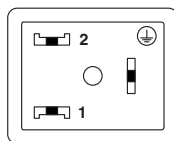

Valve connector pin assignment, type B

Cable cross section



PUR/PVC black [116]

# Double valve connector adapter - SAC-MR/0,1-116/2XB-1L-Z SCO - 1458318

Dimensioned drawing

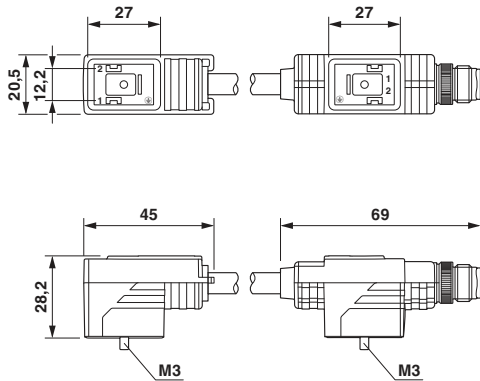

Double valve plug, 2 x type B

Dimensioned drawing

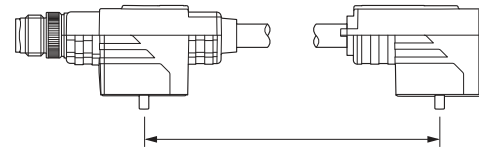

Valve connector spacing

Circuit diagram

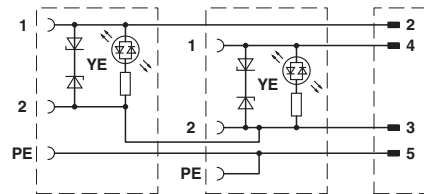

Contact assignment of the double-valve connector