

## POWER FACTOR CONTROLLER

### ■ GENERAL DESCRIPTION

The **NJM2375/A** are active power factor controllers, which limit the harmonic current resulting from the power supply block of electrical devices.

They include a startup timer, an one quadrant multiplier, a zero current detector to ensure critical condition operation, a transconductance error amplifier, high precision reference, a current sensing comparator, and a totem pole output ideally suited for driving a power MOSFET.

They also contain protection circuits for overvoltage, cycle-by-cycle overcurrent, and maximum peak current.

The startup threshold of **NJM2375A** is lower than that of **NJM2375**.

### ■ PACKAGE OUTLINE

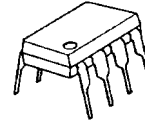

**NJM2375D/AD**



**NJM2375M/AM**



**NJM2375V/AV**

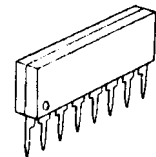

**NJM2375L/AL**

### ■ FEATURES

- Overvoltage Comparator Eliminates Runaway Output Voltage
- Internal Quick Start
- Internal Startup Timer
- One Quadrant Multiplier
- Zero Current Detector
- High Precision Reference ( $\pm 2\%$ )
- Totem Pole Output with High State Clamp
- Undervoltage Lockout  
(Startup Threshold/**NJM2375**:13V typ., **NJM2375A**:10.4V typ.)
- Low Startup and Operating Current
- Bipolar Technology
- Package Outline DIP8,DMP8,SSOP14,SIP8

### ■ PIN CONFIGURATION

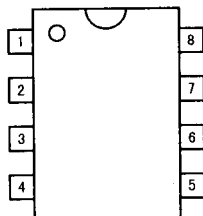

**NJM2375D/AD**  
**NJM2375M/AM**

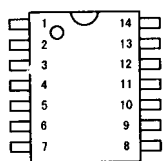

**NJM2375V/AV**

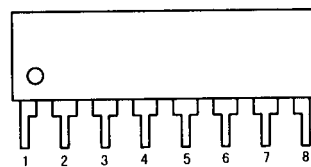

**NJM2375L/AL**

#### PIN FUNCTION

- |                       |                      |
|-----------------------|----------------------|
| 1. M <sub>ULT</sub>   | 8. DRIVE             |
| 2. NC                 | 9. NC                |
| 3. C <sub>SENSE</sub> | 10. V <sup>+</sup>   |
| 4. NC                 | 11. NC               |
| 5. D <sub>ZERO</sub>  | 12. V <sub>FB</sub>  |
| 6. NC                 | 13. NC               |
| 7. GND                | 14. C <sub>OMP</sub> |

#### PIN FUNCTION

1. V<sub>FB</sub>
2. C<sub>OMP</sub>
3. M<sub>ULT</sub>
4. C<sub>SENSE</sub>
5. D<sub>ZERO</sub>
6. GND
7. DRIVE
8. V<sup>+</sup>

# NJM2375/A

## ■ BLOCK DIAGRAM

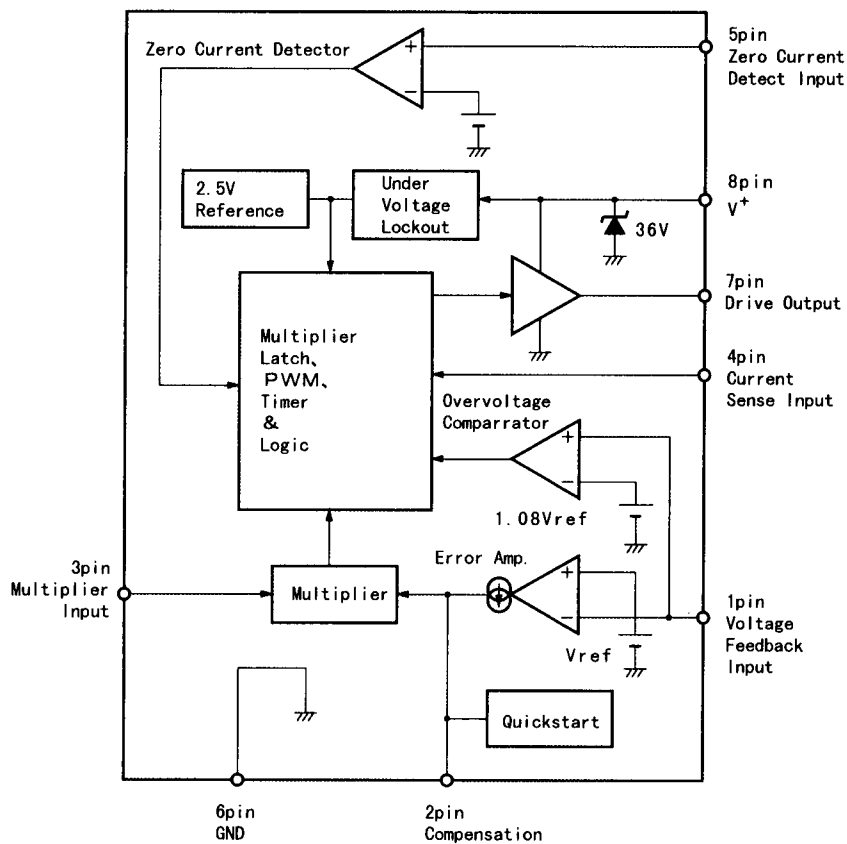

## ■ ABSOLUTE MAXIMUM RATINGS (T<sub>a</sub>=25°C)

PARAMETER	SYMBOL	RATINGS	UNIT
Total Power Supply and Zener Current	I <sub>CC+Iz</sub>	30	mA
Output Current (Source or Sink)	I <sub>O</sub>	500	mA
Current Sense, Multiplier, and Voltage Feedback Inputs	V <sub>IN</sub>	-1.0 to +10	V
Zero Current Detect Input			
High State Forward Current	I <sub>IN</sub>	50	mA
Low state Forward Current		-10	
Power Dissipation	P <sub>D</sub>	(DIP8) 500 (DMP8) 300 (SSOP14) 300 (SIP8) 700	mW
Operating Temperature Range	T <sub>OPR</sub>	-40 to +85	°C
Storage Temperature Range	T <sub>STG</sub>	-50 to +150	°C

## ■ ELECTRICAL CHARACTERISTICS ( $V^+=12V^{*1}$ , $T_a=25^{\circ}C$ )

### ● ERROR AMPLIFIER

PARAMETER	SYMBOL	TEST CONDITION	MIN.	TYP.	MAX.	UNIT
Voltage Feedback input Threshold 1	$V_{FB1}$	$V^+=12V$	2.465	2.500	2.535	V
Voltage Feedback input Threshold 2	$V_{FB2}$	$V^+=28V$	2.440	2.500	2.540	V
Line Regulation	RegLine	$V^+=12$ to $28V$	-	1.0	10	mV
Input Bias Current	$I_{IB}$	$V_{FB}=0V$	-	-0.1	-0.5	$\mu A$
Transconductance	gm		80	100	130	$\mu mho$
Output Current (Source)	$I_{OSO}$	$V_{FB}=2.3V$	-	10	-	$\mu A$
Output Current (Sink)	$I_{OSI}$	$V_{FB}=2.7V$	-	10	-	$\mu A$
Output Voltage Swing 1	$V_{OH(ea)}$	$V_{FB}=2.3V$ (High State)	5.8	6.4	-	V
Output Voltage Swing 2	$V_{OL(ea)}$	$V_{FB}=2.7V$ (Low State)	-	1.7	2.4	V

### ● OVERVOLTAGE COMPARATOR

PARAMETER	SYMBOL	TEST CONDITION	MIN.	TYP.	MAX.	UNIT
Voltage Feedback Input Threshold	$V_{FB(OV)}$		1.065 $\times V_{FB}$	1.080 $\times V_{FB}$	1.095 $\times V_{FB}$	V

### ● MULTIPLIER

PARAMETER	SYMBOL	TEST CONDITION	MIN.	TYP.	MAX.	UNIT
Input Bias Current	$I_{IB}$	$V_{FB}=0V$ (FB Pin)	-	-0.1	-0.5	$\mu A$
Input Threshold	$V_{th(M)}$	(FB Pin)	1.05 $V_{OL}$ $\times$ (EA)	1.20 $V_{OL}$ $\times$ (EA)	-	V
Dynamic Input Voltage Range	$V_{PIN3}$	Multiplier Input Pin	0 to 2.5	0 to 3.5	-	V
	$V_{PIN2}$	Compensation Pin	$V_{th(M)}$ to $V_{th(M)}$ +1.0V	$V_{th(M)}$ to $V_{th(M)}$ +1.5V	-	V
Multiplier Gain <sup>*2</sup>	K	$V_{mp}=0.5V$ , $V_{comp}=V_{th(M)}+1.0V$	0.43	0.65	0.87	$\mu mho$

### ● ZERO CURRENT DETECTOR

PARAMETER	SYMBOL	TEST CONDITION	MIN.	TYP.	MAX.	UNIT
Input Threshold Voltage	$V_{th}$	$V^+$ Increasing	1.33	1.60	1.87	V
Hysteresis	$V_H$	$V^+$ Decreasing	100	200	300	mV
Input Clamp Voltage	$V_{IH}$	High State ( $I_{DET}=+3.0mA$ )	5.20	5.80	-	V
	$V_{IL}$	Low State ( $I_{DET}=-3.0mA$ )	0.30	0.70	1.00	V

# NJM2375/A

## ■ ELECTRICAL CHARACTERISTICS ( $V^+=12V^{*1}$ , $T_a=25^\circ C$ )

### ● CURRENT SENSING COMPARATOR

PARAMETER	SYMBOL	TEST CONDITION	MIN.	TYP.	MAX.	UNIT
Input Bias Current	$I_{IB}$	$I_{sense}=0V$	-	-0.15	-1.0	$\mu A$
Input Offset Voltage	$V_{IO}$	$V_{compe}=1.10V$ , $V_M=0V$	-	9.0	25.0	mV
Maximum Current Sense Input Threshold *3	$V_{th(MAX)}$		1.30	1.50	1.80	V
Delay to Output	tPHL		-	200	-	nS

### ● DRIVE OUTPUT

PARAMETER	SYMBOL	TEST CONDITION	MIN.	TYP.	MAX.	UNIT
Output Voltage Low State	$V_{OL1}$	$I_{sink}=20mA$	-	0.3	0.8	V
	$V_{OL2}$	$I_{sink}=200mA$	-	2.4	3.3	V
Output Voltage High State	$V_{OH1}$	$I_{source}=20mA$	9.8	10.3	-	V
	$V_{OH2}$	$I_{source}=200mA$	7.8	8.4	-	V
Output Voltage High State	$V_{C(MAX)}$	$I_{source}=20mA$ , $CL=15pF$ , $V^+=30V$	14	16	18	V
Output Voltage Rise Time	tr	$CL=1.0nF$	-	100	150	nS
Output Voltage Fall Time	tf	$CL=1.0nF$	-	50	120	nS
Output Voltage with UVLO Activated	$V_{C(UVLO)}$	$V^+=7V$ , $I_{sink}=1.0mA$	-	0.1	0.5	V

### ● RESTART TIMER

PARAMETER	SYMBOL	TEST CONDITION	MIN.	TYP.	MAX.	UNIT
Restart Time Delay	tDLY		200	620	-	$\mu S$

■ ELECTRICAL CHARACTERISTICS ( $V^+=12V^{*1}$ ,  $T_a=25^\circ C$ )

● UNDERVOLTAGE LOCKOUT

PARAMETER	SYMBOL	TEST CONDITION	MIN.	TYP.	MAX.	UNIT
(NJM2375)						
Startup Threshold	$V_{th(on)}$	$V^+$ Increasing	11.5	13.0	14.5	V
Minimum Operating	$V_{shutdown}$	$V^+$ Decreasing	7.0	8.0	9.0	V
Voltage After Turn-On Hysteresis	$V_H$		3.8	5.0	6.2	V
(NJM2375A)						
Startup Threshold	$V_{th(on)}$	$V^+$ Increasing	9.4	10.4	11.4	V
Minimum Operating	$V_{shutdown}$	$V^+$ Decreasing	6.8	7.8	8.8	V
Voltage After Turn-On Hysteresis	$V_H$		1.4	2.6	3.8	V

● TOTAL DEVICE

PARAMETER	SYMBOL	TEST CONDITION	MIN.	TYP.	MAX.	UNIT
Power Supply Current						
Startup	$I_{CC1}$	$V^+=7.0V$	-	0.25	0.4	mA
Operating	$I_{CC2}$		-	6.5	12	mA
Dynamic Operating	$I_{CC3}$	50kHz, $CL=1.0nF$	-	9.0	20	mA
Power Supply Zener Voltage <sup>*4</sup>	$V_Z$	$I_{CC}=25mA$	30	36	-	V

● NOTES

\*1 : Adjust  $V^+$  above the startup threshold before setting to 12V.

$$*2 : K = \frac{V_{th(max)}}{V_M \times (V_{comp} - V_{th(M)})}$$

\*3 : This parameter is measured with  $V_{FB}=0V$ , and  $V_M=3.0V$ .

\*4 : Do not supply higher voltage above the zener voltage to 8pin, because the internal zener diode protects the IC from surge.

# NJM2375/A

## ■ TYPICAL APPLICATIONS

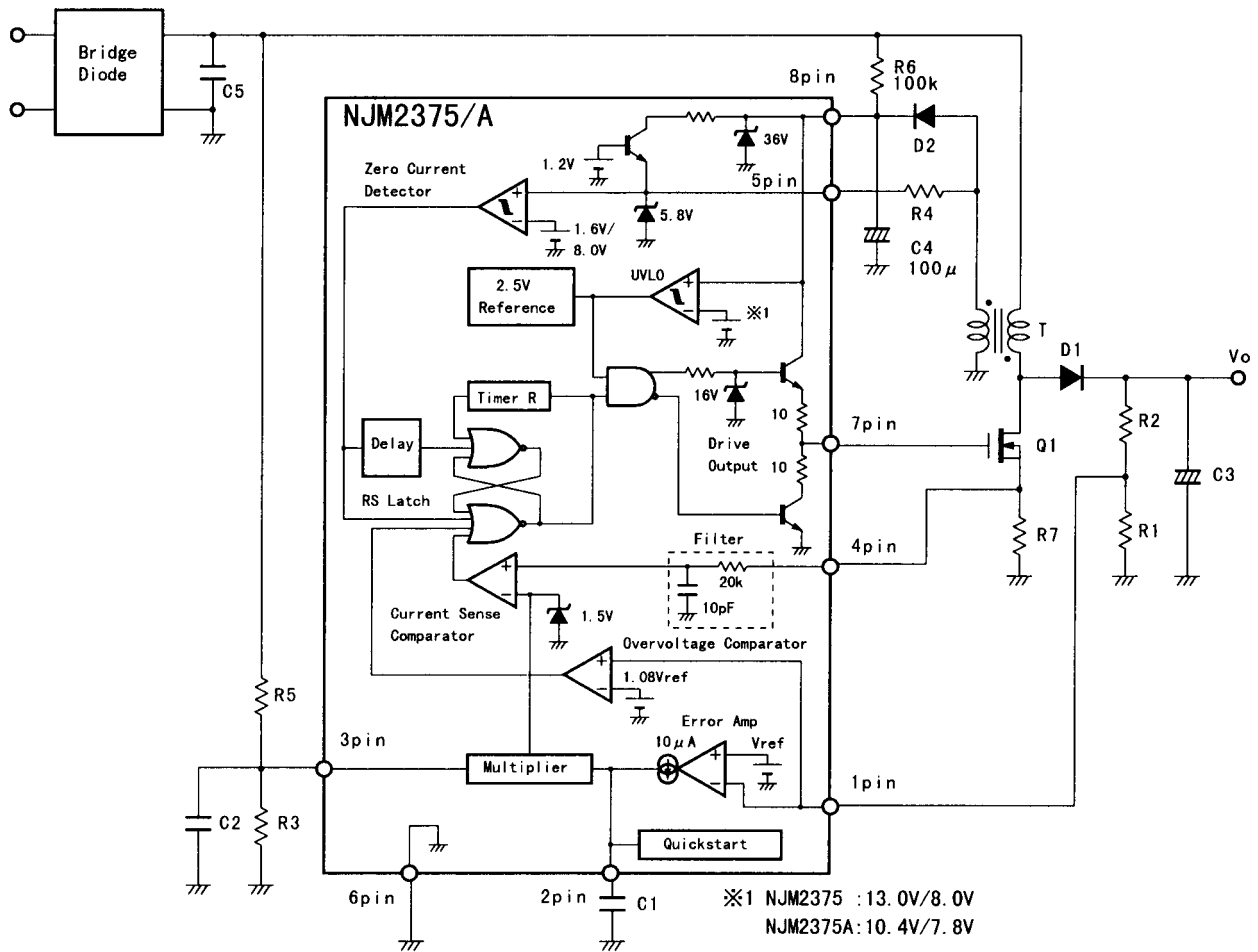

## ■ TYPICAL CHARACTERISTICS

**Current Sense Input Threshold vs. Multiplier Input**  
( $V^+ = 12V, T_a = 25^\circ C$ )

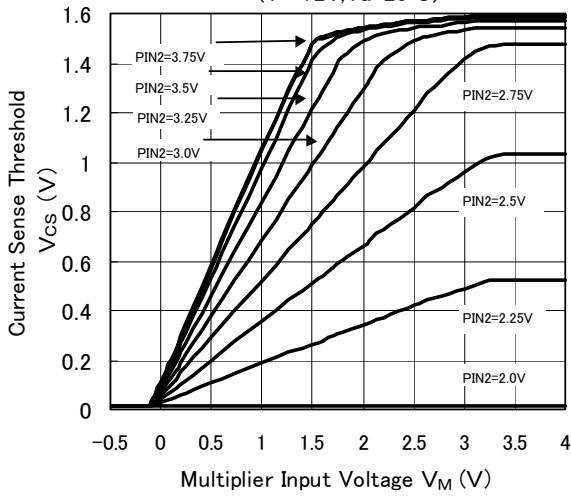

**Current Sense Input Threshold vs. Multiplier Input (Expanded View)**  
( $V^+ = 12V, T_a = 25^\circ C$ )

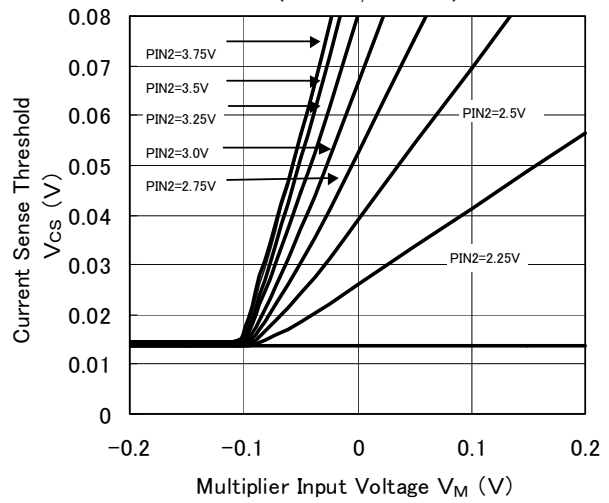

**Supply Current vs. Supply Voltage (NJM2375)**  
( $V_{FB} = 0V, C_L = 1nF, f = 50kHz, T_a = 25^\circ C$ )

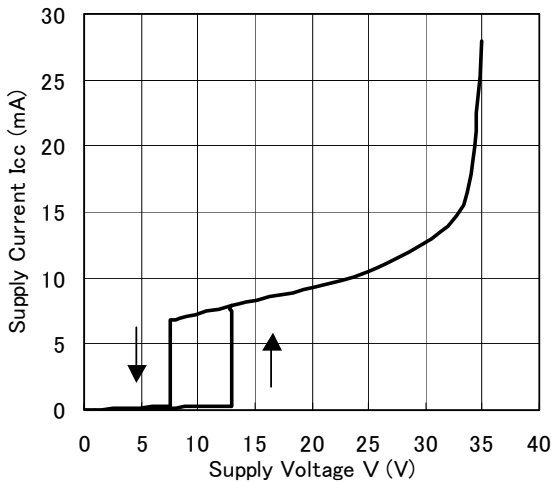

**Supply Current vs. Supply Voltage (NJM2375A)**  
( $V_{FB} = 0V, C_L = 1nF, f = 50kHz, T_a = 25^\circ C$ )

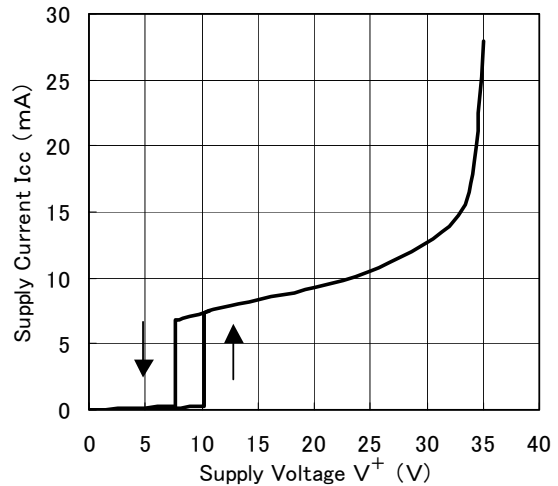

**Drive Output Voltage vs. Output Current**  
( $V^+ = 12V, T_a = 25^\circ C$ )

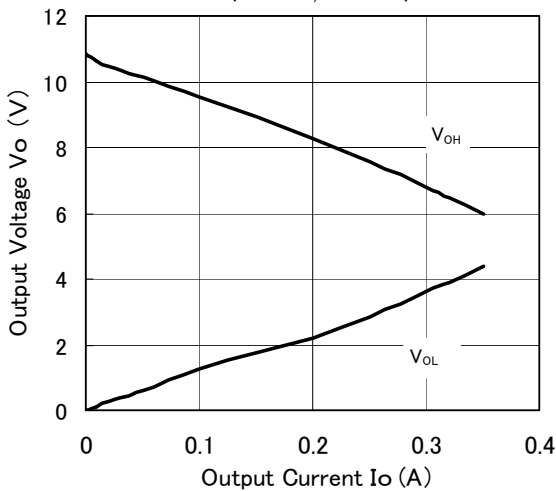

**Drive Output Waveform**  
( $V^+ = 12V, C_L = 1nF, f = 150kHz, T_a = 25^\circ C$ )

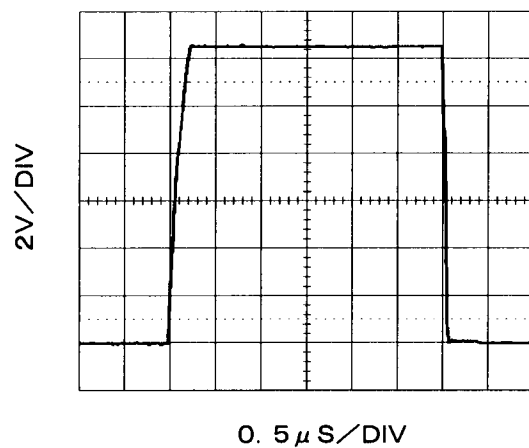

## ■ TYPICAL CHARACTERISTICS

**Voltage Feedback Input Threshold Change vs. Temperature ( $V^+=12V$ )**

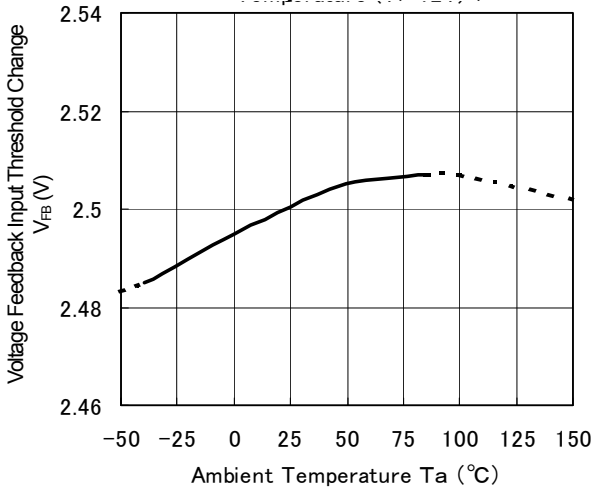

**Overvoltage vs. Temperature ( $V^+=12V$ )**

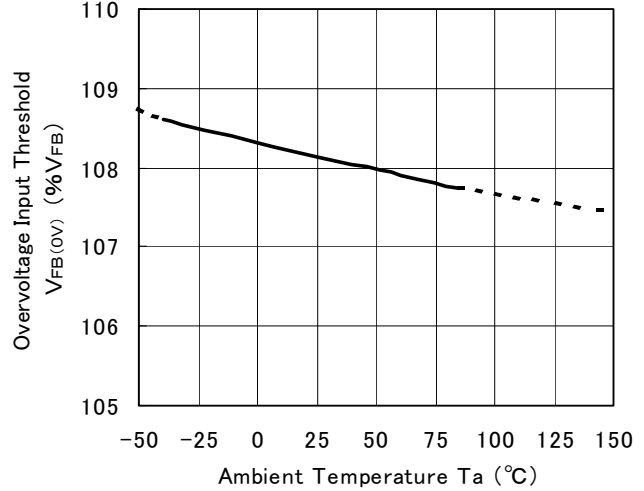

**Quickstart Charge Voltage - Current vs. Temperature ( $V^+=12V$ )**

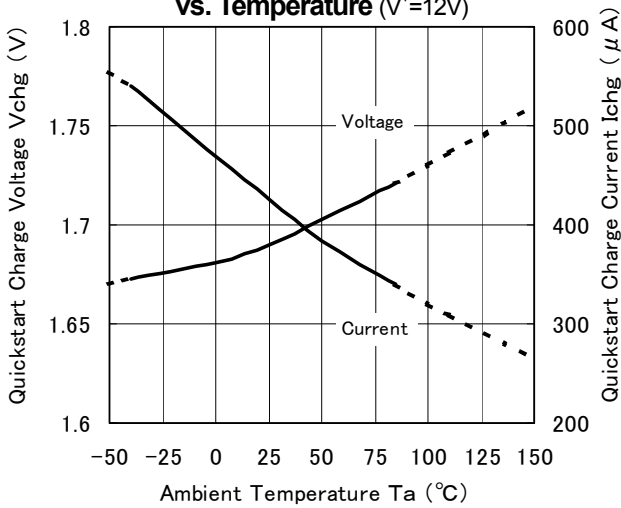

**Restart Timer Delay vs. Temperature ( $V^+=12V$ )**

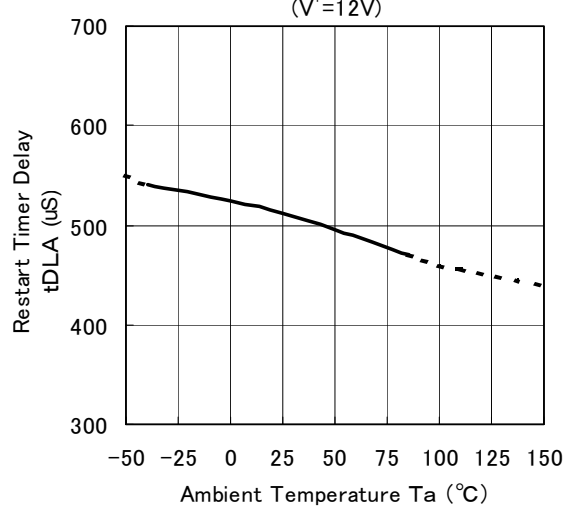

**Undervoltage Lockout Thresholds vs. Temperature**

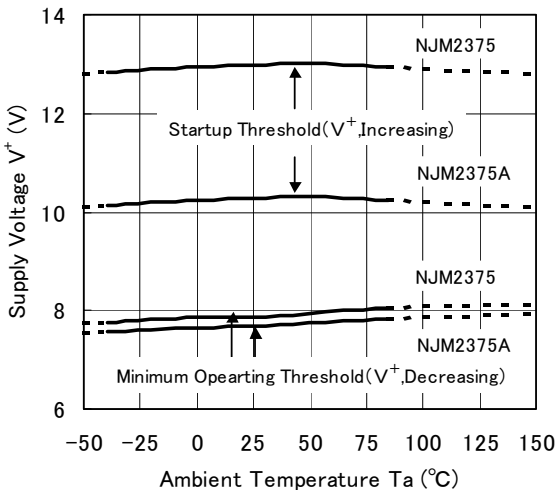

**Zero Current Detector Input Threshold Voltage vs. Temperature ( $V^+=12V$ )**

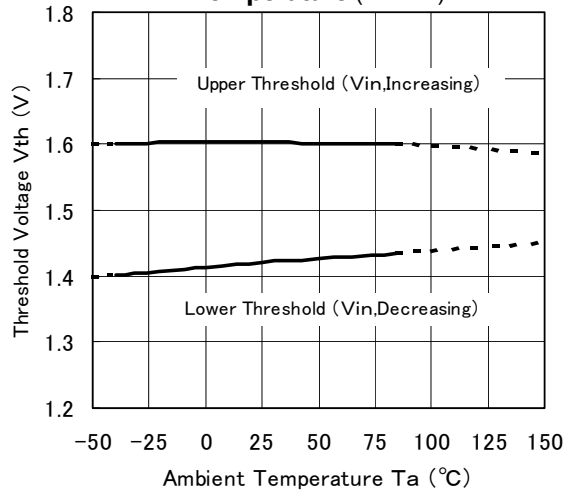



**[CAUTION]**

The specifications on this databook are only given for information, without any guarantee as regards either mistakes or omissions. The application circuits in this databook are described only to show representative usages of the product and not intended for the guarantee or permission of any right including the industrial rights.