

TPS65982 Evaluation Module

This document is the user's guide for the TPS65982 Evaluation Module (TPS65982-EVM). The TPS65982-EVM allows for evaluation of the TPS65982 IC as part of a stand-alone testing kit and for development and testing of USB Type-C and Power Delivery (PD) end products.

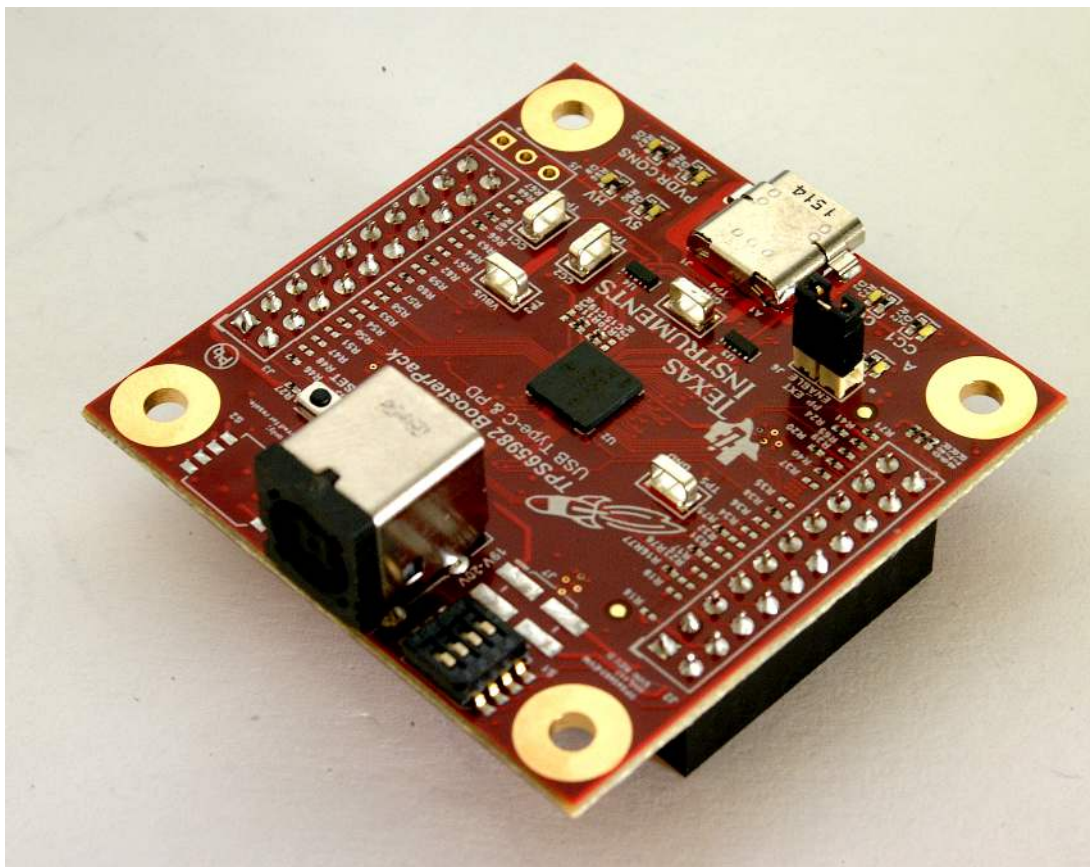

Contents

1	About this Manual.....	4
2	Information About Cautions and Warnings	4
3	Items Required for Operation	4
4	Introduction	5
4.1	Using the TPS65982 on the TPS65982-EVM.....	5
5	Setup	8
5.1	Header, Jumper, Switch, Push Button and Test Point Descriptions	8
5.2	LED Descriptions	10
5.3	Getting Started Using the TPS65982-EVM	11
6	Schematic	29
7	Board Layout.....	31
8	Bill of Materials	35
9	Firmware Installation.....	38

Tiva, Code Composer Studio, Thunderbolt are trademarks of Texas Instruments.

9.1	Writing a Flash Image Using an Aardvark SPI Programmer	38
9.2	Wire Aardvark to SPI Pins for Flash on the TPS65982-EVM board.....	39
9.3	Run “Flash Center”.exe.....	39
9.4	Add Adapter.....	40
9.5	Choose Target (Device Type)	41
9.6	Load Binary File	42
9.7	Program TPS65982-EVM	43
9.8	Verify (Optional)	43

List of Figures

1	TPS65982-EVM (Top View)	6
2	TPS65982-EVM (Bottom View)	7
3	TPS65982-EVM Schematic Page 1	29
4	TPS65982-EVM Schematic Page 2	30
5	PCB Layer 1 (Top Layer).....	31
6	PCB Layer 1 (Component View)	31
7	PCB Layer 2 (GND Plane)	32
8	PCB Layer 3 (Inner Signal Layer 1)	32
9	PCB Layer 4 (GND Plane)	33
10	PCB Layer 5 (Inner Signal Layer 2)	33
11	PCB Layer 6 (Bottom Layer).....	34
12	PCB Layer 6 (Component View)	34
13	Legend.....	38
14	Aardvark Wired to SPI Pins	39
15	Flash Center GUI	39
16	Add Adapters... Button.....	40
17	Add Adapters Selection	40
18	Adapter Detection	40
19	Select Target Device.....	41
20	Loading Data Section of Flash Center	42
21	Programming the TPS65982-EVM.....	43
22	Verifying Binary Image.....	43

List of Tables

1	Device and Package Configurations	5
2	TPS65982-EVM Configuration Table	13
3	Configuration ID 0	14
4	Configuration ID 1	15
5	Configuration ID 2	16
6	Configuration ID 3	17
7	Configuration ID 4	18
8	Configuration ID 5	19
9	Configuration ID 6	20
10	Configuration ID 7	21
11	Configuration ID 8	22
12	Configuration ID 9	23
13	Configuration ID 10	24
14	Configuration ID 11	25
15	Configuration ID 12	26
16	Configuration ID 13	27

17	Configuration ID 14	27
18	Configuration ID 15	28
19	Bill of Materials	35

1 About this Manual

This user's guide describes the TPS65982-EVM. This guide contains an introduction, setup instructions, the EVM schematic, top and bottom board layouts and component views, internal VDD and GND plane layouts, and a bill of materials (BOM).

2 Information About Cautions and Warnings



CAUTION

This EVM contains components that can potentially be damaged by electrostatic discharge. Always transport and store the EVM in its supplied ESD bag when not in use. Handle using an antistatic wristband. Operate on an antistatic work surface. For more information on proper handling, see the *Electrostatic Discharge (ESD)* application note ([SSYA008](#)).

The information in a caution or a warning is provided for your protection. Read each caution and warning carefully.

3 Items Required for Operation

The following items are required to use the TPS65982-EVM:

- TPS65982 ([SLVSD02](#)) datasheet
- TPS65982-EVM
- Barrel jack AC Adapter, DC power supply, or Tiva™ C-Series LaunchPad to supply power

The following items are recommended for developing firmware for an attached processor to control the TPS65982-EVM:

- Tiva C-Series [EK-TM4C123GXL](#) LaunchPad
- USB standard-A to mini-B cable
- Computer with [Code Composer Studio™](#) installed

4 Introduction

This document is the user's guide for the TPS65982-EVM.

The TPS65982-EVM allows a simple way to evaluate the TPS65982. The TPS65982-EVM is built with a USB Type-C receptacle and TPS65982 to detect another TPS65982-EVM or other Type-C host/device via a USB Type-C cable. The TPS65982 detects the plug event and/or presence of another Type-C product on the CC1 or CC2 pin and provides or consumes power on the VBUS pin. The TPS65982-EVM also supports dead battery mode and can be powered by another TPS65982-EVM or other USB Type-C power provider. After CC detection and Type-C power is established, the TPS65982 will attempt to negotiate a USB Power Delivery (PD) contract to provide or consume additional power. After a USB PD contract is negotiated, the TPS65982 will attempt to enter an Alternate Mode. The TPS65982-EVM can be used to emulate other USB Type-C and PD products, such as a dock, a notebook computer, a tablet, a dongle, an AC charger adapter, and a high-power bus-powered device. The GPIOs of the TPS65982 are routed to the EVM J2 and J3 headers and can also be used to control external SuperSpeed and DisplayPort multiplexers.

4.1 Using the TPS65986 on the TPS65982-EVM

The TPS65986 is a pin-to-pin compatible device and is drop-in replaceable with the TPS65982. The following list shows the differences and similarities between the TPS65982 and TPS65986:

- TPS65982 and TPS65986 firmware can be used in both devices
 - Note that some functions may not be present
- TPS65986 does not have the PP_EXT FET control from the TPS65982
- TPS65986 does not have the secondary I2C port from the TPS65982

Table 1. Device and Package Configurations

EVM Annotation	IC	Package
U2	TPS65982ABZQZR	BGA (96 pins)

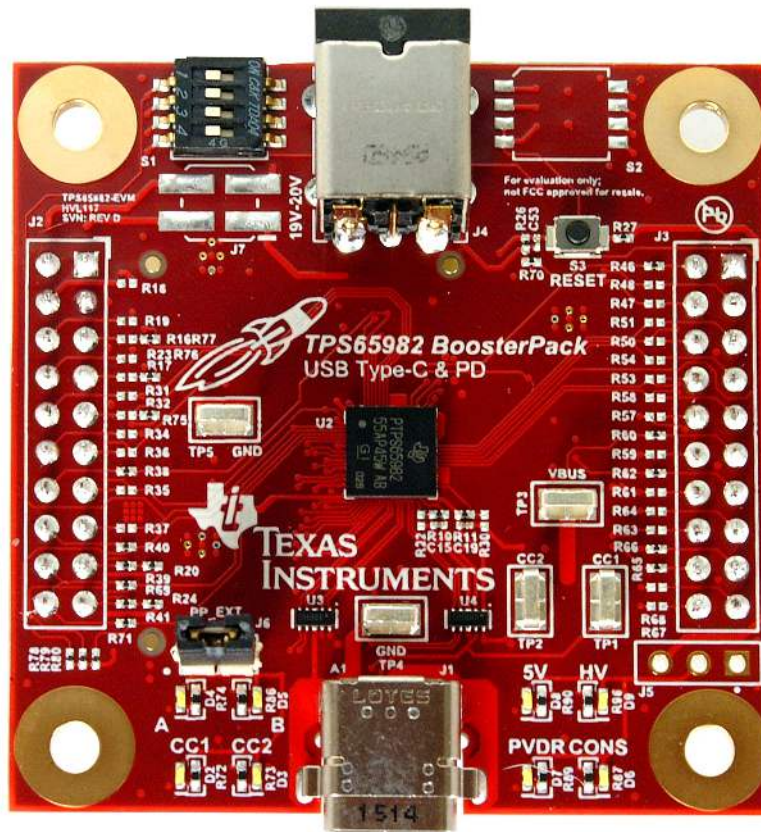

Figure 1. TPS65982-EVM (Top View)

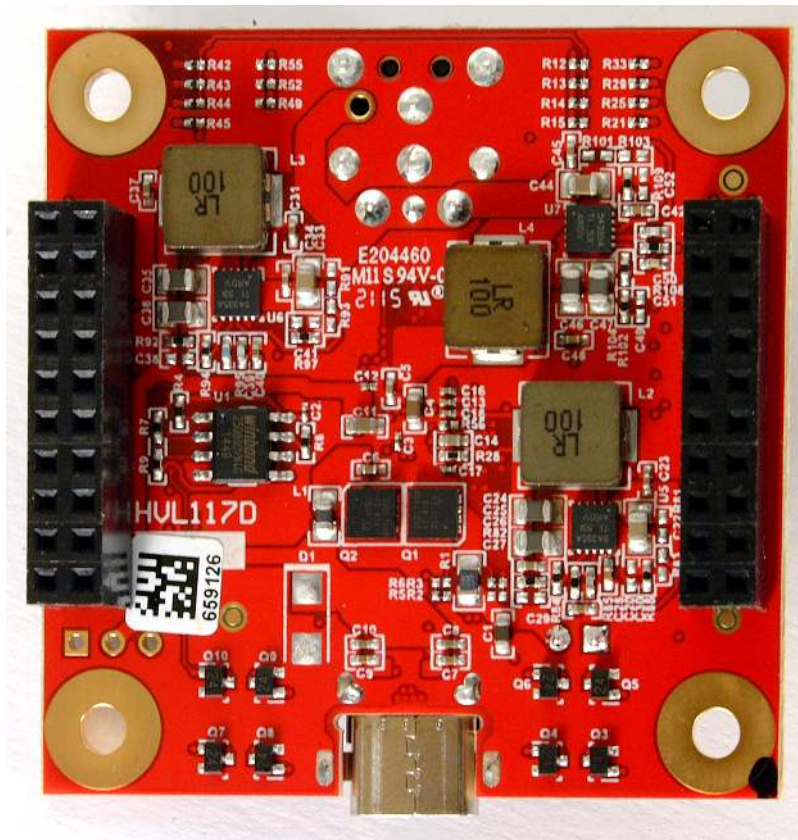

Figure 2. TPS65982-EVM (Bottom View)

5 Setup

This section describes the header/jumper connections on the EVM and getting started using the TPS65982-EVM.

5.1 Header, Jumper, Switch, Push Button and Test Point Descriptions

The headers, jumpers, switches, push buttons, and test points are listed in the order they can be found on the PCB, from top left to bottom right, across then down. However, related jumpers/headers/test points are listed simultaneously.

5.1.1 S1: Switch Bank #1

Switch bank S1 contains four DIP switches, three of which are used to control the three bits/pins [B2:B0] of the configuration options for the TPS65982-EVM, shown in [Table 2](#). Bit [B0] is connected to the GPIO1 pin of the TPS65982 IC (U2) and is pulled low when the upper-most switch is pushed to the left-hand side, pin 1 of S1. Bit [B0] is pulled high when the upper-most switch is pushed to the right-hand side, pin 8 of S1. Bit [B1] is connected to the DEBUG3 pin of the TPS65982 IC (U2) and is pulled low when the middle-upper switch is pushed to the left-hand side, pin 2 of S1. Bit [B1] is pulled high when the middle-upper switch is pushed to the right-hand side, pin 7 of S1. Bit [B2] is connected to the DEBUG4 pin of the TPS65982 IC (U2) and is pulled low when the middle-lower switch is pushed to the left-hand side, pin 3 of S1. Bit [B2] is pulled high when the middle-lower switch is pushed to the right-hand side, pin 6 of S1. Bit [B3] is connected to the TPS65982 IC (U2), however, is not used for any configuration.

5.1.2 S2 (Not Populated): Switch Bank #2

Switch bank S2 contains four DIP switches which are used to control four bits/pins [B3:B0] of the TPS65982-EVM. Bit [B0] is connected to the DEBUG_CTL1 pin of the TPS65982 IC (U2) and is pulled low when the upper-most switch is pushed to the left-hand side, pin 1 of S1. Bit [B0] is pulled high when the upper-most switch is pushed to the right-hand side, pin 8 of S1. Bit [B1] is connected to the DEBUG_CTL2 pin of the TPS65982 IC (U2) and is pulled low when the middle-upper switch is pushed to the left-hand side, pin 2 of S1. Bit [B1] is pulled high when the middle-upper switch is pushed to the right-hand side, pin 7 of S1. Bit [B2] is connected to the BUSPOWERZ and LDO_3V3 pins of the TPS65982 IC (U2) while bit [B3] is connected to the BUSPOWERZ and LDO_1V8D pins of the TPS65982 IC (U2). BUSPOWERZ is pulled low when the middle-lower and lowest switches are pushed to the left-hand side, pins 3 and 4 of S1. Bit [B2] is pulled high and BUSPOWERZ is pulled up to LDO_3V3 when the middle-lower switch is pushed to the right-hand side, pin 6 of S1. Bit [B3] is pulled high and BUSPOWERZ is pulled up to LDO_1V8D when the lowest switch is pushed to the right-hand side, pin 5 of S1. The middle-lower and lowest switches of S1, bits [B2] and [B3] should never both be pushed to the right-hand side, pins 6 and 5.

5.1.3 J7 (Not Populated): Tiva LaunchPad Power and System Power Jumpers

Jumper J7 is a set of 2 surface-mount jumpers to connect power from a LaunchPad to the System Power rails of the TPS65982 IC (U2). Connecting a shunt between pins 1 and 2 will connect System_5V to Tiva_5V and will allow the 5-V rail of the TPS65982-EVM to be powered by the 5-V rail of the Tiva LaunchPad. Connecting a shunt between pins 3 and 4 will connect System_3V3 to Tiva_3V3 and will allow the 3.3-V rail of the TPS65982-EVM to be powered by the 3.3-V rail of the Tiva LaunchPad. Both of these shunts can be connected simultaneously.

5.1.4 J4: Barrel Jack Receptacle for 20-V AC Adapter

Receptacle J4 is intended to mate with a barrel-jack plug that will provide 20-V DC that has been rectified by an AC Adapter. The size, polarity, and voltage of the plug must match in order to safely provide power to the External Power rail TPS65982-EVM. A standard Dell or HP notebook adapter or similar will provide the needed power. For example, the Dell 130W Part Number: 492-BBGP.

5.1.5 S3: RESET Push-Button

Switch S3 is a push-button that will pull the HRESET pin (D6) of the TPS65982 IC (U2) high when pressed. Releasing the push-button will pull HRESET low again and the TPS65982 IC (U2) will go through a hardware reset and reload firmware from the non-volatile memory of the Flash IC (U1).

5.1.6 J2 and J3: LaunchPad Receptacles

Receptacles J2 and J3 allow the TPS65982-EVM to interface with a standard TI LaunchPad. See the TPS65982-EVM schematic in [Figure 4](#) and [Figure 4](#) to determine which signals from the LaunchPad are connected to the TPS65982 IC (U2), or refer to [Section 5.3.3](#) for a description of these connections.

5.1.7 TP5 and TP4 (GND): Ground (GND) Test Points

Test points TP4 and TP5, labeled GND, are connected to signal ground which is also connected to the GND pins of the TPS65982 IC (U2). There are two test points on the board for easy attachment of oscilloscope or multimeter ground connections. They are both connected directly to the signal ground plane. Power, analog signals, and digital signals are all directly connected to GND.

5.1.8 TP3 (VBUS): VBUS Test Point

Test point TP3 provides a location to probe the voltage on VBUS, the input or output power rail connected at the Type-C receptacle (J1).

5.1.9 TP2 (CC2): CC2 Test Point

Test point TP2 provides a location to probe the voltage on CC2, the secondary Cable Connection signal connected at the Type-C receptacle (J1). When a Type-C cable is plugged in upside-down, the CC2 signal is connected to the CC wire of the cable and the CC1 pin of the TPS65982 IC (U2). When a cable is plugged in right-side up, the CC2 signal is connected to the VCONN wire of the cable and the CC2 pin of the TPS65982 IC (U2).

5.1.10 TP1 (CC1): CC1 Test Point

Test point TP1 provides a location to probe the voltage on CC1, the primary Cable Connection signal connected at the Type-C receptacle (J1). When a Type-C cable is plugged in right-side up, the CC1 signal is connected to the CC wire of the cable and the CC1 pin of the TPS65982 IC (U2). When a cable is plugged in upside-down, the CC1 signal is connected to the VCONN wire of the cable and the CC2 pin of the TPS65982 IC (U2).

5.1.11 J6 (PP_EXT ENABLE): PP_EXT to External Power Jumper

Jumper J6 is a jumper which connects power from the External Power rail provided at J4 to the PP_EXT external NexFETS (Q1 and Q2) rated for 20 V and 5 A of current. Pin 1 of this jumper is connected to J4 and pin 2 is connected to the External Power rail of the system; therefore, if this jumper is shunted and a 20-V DC power supply is connected, the external DC power supply will provide the External Power rail to the system and to the PP_EXT external FET path.

5.1.12 J5 (Not Populated): Header for System_3V3, System_5V, and HV_Source

Header J5 is not populated, but provides test points for probing the voltage on the HV_Source rail at pin 1 (marked by rectangular pad), the voltage on the System_5V rail at pin 2, and the voltage on the System_3V3 rail at pin 3. If J5 is installed, a DC power supply may also be used to apply 12 V to the HV_Source rail, 5 V to the System_5V rail, and/or 3.3 V to the System_3V3 rail when J4 is not used, J6 is not used, and/or J7 is not used to provide power to these rails of the system.

5.1.13 J1: USB Type-C Receptacle

Receptacle J1 is the USB Type-C port where a USB Type-C cable can be plugged into the TPS65982-EVM.

5.2 LED Descriptions

The headers, jumpers, switches, push buttons, and test points are listed in the order they can be found on the PCB, from top left to bottom right, across then down. However, related jumpers/headers/test points are listed simultaneously.

5.2.1 D2: CC1 Cable Orientation Indicator (White LED)

LED D2, labeled **CC1**, is an indicator of the cable orientation which is ON when the USB Type-C cable is inserted right-side up.

5.2.2 D3: CC2 Cable Orientation Indicator (White LED)

LED D3, labeled **CC2**, is an indicator of the cable orientation which is ON when the USB Type-C cable is inserted upside-down.

5.2.3 D4: DisplayPort (A) Indicator (White LED)

LED D4, labeled **A**, is an indicator that the TPS65982-EVM has established a Power Delivery contract and entered the alternate mode, DisplayPort. This indicator will blink ON and OFF when 2 Lane DisplayPort alternate mode is entered and will remain solid when 4 Lane DisplayPort alternate mode is entered.

5.2.4 D5: Thunderbolt™ and APP FW Loaded Indicator (White LED)

LED D5, labeled **B**, is an indicator that the application firmware has loaded on the TPS65982-EVM. When the TPS65982-EVM is powered up and connected to no other device, and the App FW has successfully loaded it, the LED will be ON. This indicator will blink ON and OFF when a USB PD contract has been negotiated and the Thunderbolt alternate mode has been entered.

5.2.5 D6: Consumer (CONS) Indicator (White LED)

LED D6, labeled **CONS**, is an indicator of the consumer/provider role which is ON when the TPS65982 IC (U2) has negotiated a USB PD contract to be a power consumer, or sink.

5.2.6 D7: Provider Indicator (White LED)

LED D7, labeled **PVDR**, is an indicator of the USB PD voltage which is ON when a USB PD contract has been negotiated for 5 V as a provider.

5.2.7 D8: 5 Volts (5V) Power Indicator (White LED)

LED D8, labeled **5V**, is an indicator of the USB PD voltage which is ON when a USB PD contract has been negotiated for 5 V as a provider.

5.2.8 D9: High Voltage (HV) Power Indicator (White LED)

LED D9, labeled **HV**, is an indicator of the USB PD voltage which is ON when a USB PD contract has been negotiated for 12 V as a provider. This indicator will blink ON and OFF when a USB PD contract has been negotiated for 20 V as a provider or consumer.

5.3 Getting Started Using the TPS65982-EVM

5.3.1 Powering the TPS65982-EVM

There are many viable options for providing power to the TPS65982-EVM. Sections [Section 5.3.1.1](#) through [Section 5.3.1.5](#) describe all of these options for powering the EVM.

5.3.1.1 Powering the EVM From J4

When a barrel jack plug of the appropriate voltage, size, and polarity is inserted in J4, all of the power rails of the TPS65982-EVM (System_3V3, System_5V, and HV_Source) will automatically be generated by the DCDC buck converters (U5, U6, and U7, respectively) from the External Power rail. When a shunt is installed on J6, the External Power rail will also provide power to the PP_EXT FETs (Q1 and Q2).

5.3.1.2 Powering the EVM From J6

When a shunt is installed on J6 and a 20-V DC power supply is connected to either pin, the External Power rail will generate all of the power rails for the TPS65982-EVM and will also provide power to the PP_EXT FETs (Q1 and Q2).

5.3.1.3 Powering the EVM From J7 and J5

When J4 and J6 are not used and a Tiva LaunchPad is used, both shunts on Jumper J7 should be installed to provide power to the System_3V3 and System_5V power rails of the TPS65982-EVM from a LaunchPad's 3.3-V and 5-V rails, labeled Tiva_3V3 and Tiva_5V. When power is provided by a LaunchPad, 12 V can be supplied to the HV_Source rail by a DC power supply at pin 1 of J5.

5.3.1.4 Powering the EVM From J6 and J5

When J6 is not used to supply power to External Power and a LaunchPad is not used, the 20-, 12-, 5-, and 3.3-V rails can all be supplied by a DC power supply. 20 V should be applied to PP_EXT at pin 2 of J6, 12 V should be applied to HV_Source at pin 1 of J5, 5 V should be applied to System_5V at pin 2 of J5, and 3.3 V should be applied to System_3V3 at pin 3 of J5.

5.3.1.5 Power the EVM from the USB Type-C Port

When a 0-Ω resistor is installed at R10 and R11, RPD_G1 and RPD_G2 are shorted to CC1 and CC2 respectively, and dead battery mode is supported by the TPS65982-EVM. Depending on the configuration used (see [Table 2](#)), the TPS65982-EVM will negotiate a USB PD contract for 5 V at 3 A, 12 V at 3 A, 12–20 V at 3 A, 20 V at 3 A, or 20 V at 5 A and will provide power to portions of the system depending on whether the PP_EXT external FET or PP_HV internal FET is used to sink power.

NOTE: When a USB PD contract is negotiated for 5 V, it is common for the LEDs to blink due to the switching behavior of the buck converter U6, which produces the System_5V rail. When blinking on the LEDs occurs, VBUS is stable at 5 V and can be measured on test point TP3.

5.3.2 Analyzing USB Type-C and PD Events Using the LEDs

When a USB Type-C cable is inserted into the USB Type-C receptacle (J1), the LEDs on the TPS65982-EVM (D2–D9 described in [Section 5.2.1–Section 5.2.8](#)) can be used to interpret what type of event has occurred and, in turn, what type of device is connected at the other end of the Type-C cable.

5.3.2.1 Cable Orientation (CC1 or CC2) Event

After a plug event (a correctly terminated USB Type-C cable has been connected with a USB Type-C product on the opposite end of the cable) has occurred, cable orientation detection of the USB Type-C cable will occur. When cable orientation detection has completed, this event will occur and either LED D2 (**CC1**) or LED D3 (**CC2**) will turn ON to indicate that the cable is inserted right-side up (**CC1** ON and **CC2** OFF) or upside-down (**CC2** ON and **CC1** OFF).

5.3.2.2 Consumer or Provider (CONS or PRVDR) Event

After a plug event has occurred and cable orientation detection is complete, a USB PD contract will be negotiated. When a USB PD contract has been successfully negotiated, this event will occur and either LED D7 (**CONS**) or LED D6 (**PVDR**) will turn ON to indicate that the TPS65982-EVM is acting as a power consumer (**CONS ON** and **PVDR OFF**) or power provider (**PVDR ON** and **CONS OFF**).

5.3.2.3 USB PD Voltage (5V, HV, or Blinking HV) Event

After a plug event has occurred, cable orientation detection is complete, and a USB PD contract has been negotiated, a voltage will be present on VBUS (TP3) at the USB Type-C port (J1). When VBUS is present, this event will occur and one of the following LED indicators may be ON or blinking ON or OFF: LED D8 (**5V**) or LED D9 (**HV**). If the TPS65982 is acting as a power provider and the voltage on VBUS is 5 V, LED D8 (**5V**) will be ON. If the TPS65982 is acting as a power provider and the voltage on VBUS is 12 V, LED D9 (**HV**) will be ON. If the TPS65982 is acting as a power consumer or provider and the voltage on VBUS is 20 V, LED D9 (**HV**) will be blinking ON and OFF.

5.3.2.4 DisplayPort Alternate Mode (LED A) Event

When a USB PD contract has been negotiated to enter an alternate mode for DisplayPort video, LED A (D4) will blink ON and OFF every 1 second to indicate that 2-lane DisplayPort alternate mode has been entered, and if LED A (D4) remains solid then 4 lane DisplayPort alternate mode has been entered.

5.3.2.5 Thunderbolt Alternate Mode (LED B) Event

When a USB PD contract has been negotiated to enter an alternate mode for Thunderbolt video+data, LED B (D5) will blink On and OFF every 1 second to indicate that this event has occurred.

5.3.3 TPS65982-EVM Configuration Table Overview

Configuring the TPS65982-EVM to power-on, initialize, and emulate application types is outlined in [Table 2](#), and is as simple as changing the position of the top 3 DIP switches on switch bank S1. Resetting the TPS65982 IC (U2), reloading the FW in the Flash IC (U1), and re-initializing by reading the S1 DIP switch positions can be accomplished by pressing and releasing push-button S3. A detailed description of each of the TPS65982-EVM configurations settings controlled by S1 can be found in [Section 5.3.3.1](#) through [Section 5.3.3.16](#).

Table 2. TPS65982-EVM Configuration Table

CFG ID#	Switch S1	Port Type	Type-C	PD Source Capabilities				PD Sink Capabilities			BC 1.2 Device Support	Alternate Mode Support		PD Control Response		PD Control	Application	FET Paths Used
				A	V @ A	V @ A	V @ A	V @ A	V @ A	V @ A		TBT Support	DP Support	Data Role Preferred	Power Role Preferred			
0	<input type="checkbox"/> ← 0 <input type="checkbox"/> ← 0 <input type="checkbox"/> ← 0 <input type="checkbox"/> ← 0	DRP Rpt/Rd	3	5 @ 3	12 @ 3	20 @ 5	5 @ 0	-	-	-	-	UFP_D Config C & D	UFP DR Swap to DFP - Reject DR Swap to UFP - Accept	Source PR Swap to Src - Accept PR Swap to Snk - Reject	Init DR Swap to UFP Init PR Swap to Src	Docking System	Source: 5V @ 3A PP_5V0 Source: 12V @ 3A PP_HV Source: 20V @ 5A PP_EXT	
1*	<input type="checkbox"/> ← 0 <input type="checkbox"/> ← 0 <input type="checkbox"/> ← 0 <input type="checkbox"/> ← 0	DRP Rpt/Rd	3	5 @ 3	-	-	5 @ 3	12-20 @ 3	-	Yes	-	DFP_D Config C, D, & E	DFP DR Swap to DFP - Accept DR Swap to UFP - Reject	Sink PR Swap to Src - Reject PR Swap to Snk - Accept	Init DR Swap to DFP Init PR Swap to Snk	Tablet/Ultrabook	Source: PP_5V0 FET Sink: PP_HV FET	
2	<input type="checkbox"/> ← 0 <input type="checkbox"/> ← 0 <input type="checkbox"/> ← 0 <input type="checkbox"/> ← 0	DRP Rpt/Rd	3	5 @ 3	12 @ 3	-	5 @ 0	20 @ 3	-	-	Yes	DFP_D Config C, D, & E	DFP DR Swap to DFP - Accept DR Swap to UFP - Reject	Sink PR Swap to Src - Accept PR Swap to Snk - Accept	Init DR Swap to DFP Init PR Swap to Snk	Thunderbolt Notebook	Source: 5V @ 3A PP_5V0 Source: 12V @ 3A PP_HV Sink: PP_EXT FET	
3	<input type="checkbox"/> ← 0 <input type="checkbox"/> ← 0 <input type="checkbox"/> ← 0 <input type="checkbox"/> ← 0	DRP Rpt/Rd	3	5 @ 3	20 @ 3	-	5 @ 0	20 @ 3	-	-	-	DFP_D Config C, D, & E	DFP DR Swap to DFP - Accept DR Swap to UFP - Reject	Sink PR Swap to Src - Accept PR Swap to Snk - Accept	Init DR Swap to DFP Init PR Swap to Snk	Notebook, Mobile Workstation	Source: 5V @ 3A PP_5V0 Source: 20V @ 3A PP_EXT Sink: PP_EXT FET	
4*	<input type="checkbox"/> ← 0 <input type="checkbox"/> ← 0 <input type="checkbox"/> ← 0 <input type="checkbox"/> ← 0	UFP Rd	-	-	-	-	5 @ 900mA	-	-	-	-	UFP_D Config E	UFP DR Swap to DFP - Reject DR Swap to UFP - Accept	Sink PR Swap to Src - Reject PR Swap to Snk - Accept	N/A	DP Dongle	Sink: PP_HV	
5	<input type="checkbox"/> ← 0 <input type="checkbox"/> ← 0 <input type="checkbox"/> ← 0 <input type="checkbox"/> ← 0	DRP Rpt/Rd	3	5 @ 3	12 @ 3	20 @ 5	5 @ 0	-	-	-	Yes	DFP_D Config C, D, & E	DFP/UFP DR Swap to DFP - Accept DR Swap to UFP - Accept	Source PR Swap to Src - Accept PR Swap to Snk - Reject	Init PR Swap to Src	Thunderbolt Docking System	Source: 5V @ 3A PP_5V0 Source: 12V @ 3A PP_HV Source: 20V @ 5A PP_EXT	
6	<input type="checkbox"/> ← 0 <input type="checkbox"/> ← 0 <input type="checkbox"/> ← 0 <input type="checkbox"/> ← 0	DFP Rp	3	5 @ 3	12 @ 3	20 @ 5	-	-	-	-	-	-	DR Swap to DFP - Reject DR Swap to UFP - Reject	Source PR Swap to Src - Accept PR Swap to Snk - Reject	N/A	High Power Charger Adapter	Source: 5V @ 3A PP_5V0 Source: 12V @ 3A PP_HV Source: 20V @ 5A PP_EXT	
7	<input type="checkbox"/> ← 0 <input type="checkbox"/> ← 0 <input type="checkbox"/> ← 0 <input type="checkbox"/> ← 0	UFP Rd	-	-	-	-	5V @ 3	12 @ 3	20 @ 5	-	-	-	DR Swap to DFP - Reject DR Swap to UFP - Reject	Sink PR Swap to Src - Reject PR Swap to Snk - Accept	N/A	High Power Bus Powered Device	Sink: PP_EXT	
8	<input type="checkbox"/> ← 0 <input type="checkbox"/> ← 0 <input type="checkbox"/> ← 0 <input type="checkbox"/> ← 0	DFP Rp	3	5 @ 3	12 @ 3	-	5 @ 0	-	-	-	Yes	DFP_D Config C, D, & E	DFP DR Swap to DFP - Accept DR Swap to UFP - Reject	Source PR Swap to Src - Accept PR Swap to Snk - Reject	N/A	Thunderbolt Desktop, Add-in Card	Source: 5V @ 3A PP_5V0 Source: 12V @ 3A PP_HV	
9*	<input type="checkbox"/> ← 0 <input type="checkbox"/> ← 0 <input type="checkbox"/> ← 0 <input type="checkbox"/> ← 0	DFP Rp	3	5 @ 3	12 @ 3	-	5 @ 0	-	-	-	-	DFP_D Config C, D, & E	DFP DR Swap to DFP - Accept DR Swap to UFP - Reject	Source PR Swap to Src - Accept PR Swap to Snk - Reject	N/A	Desktop, Add-in Card	Source: 5V @ 3A PP_5V0 Source: 12V @ 3A PP_HV	
10	<input type="checkbox"/> ← 0 <input type="checkbox"/> ← 0 <input type="checkbox"/> ← 0 <input type="checkbox"/> ← 0	UFP Rd	-	-	-	-	5V @ 3	12V @ 1.2	20 @ .75	-	Yes	-	UFP DR Swap to DFP - Accept DR Swap to UFP - Accept	Sink PR Swap to Src - Reject PR Swap to Snk - Accept	N/A	Thunderbolt Bus-Powered Device	Sink: PP_HV	
11	<input type="checkbox"/> ← 0 <input type="checkbox"/> ← 0 <input type="checkbox"/> ← 0 <input type="checkbox"/> ← 0	DRP Rpt/Rd	3	5 @ 3	20 @ 3	-	5 @ 1.5	20V @ 3	-	-	-	UFP_D Config D	UFP DR Swap to DFP - Reject DR Swap to UFP - Accept	Source PR Swap to Src - Accept PR Swap to Snk - Reject	Init DR Swap to UFP Init PR Swap to Src	Mini-Dock System	Source: 5V @ 3A PP_5V0 Source: 20V @ 3A PP_EXT	
12*	<input type="checkbox"/> ← 0 <input type="checkbox"/> ← 0 <input type="checkbox"/> ← 0 <input type="checkbox"/> ← 0	DFP Rp	3	5 @ 3	12 @ 3	-	-	-	-	-	-	-	DR Swap to DFP - Reject DR Swap to UFP - Reject	Source PR Swap to Src - Accept PR Swap to Snk - Reject	N/A	Mid Power Charger Adapter	Source: 5V @ 3A PP_5V0 Source: 12V @ 3A PP_HV	
13	<input type="checkbox"/> ← 0 <input type="checkbox"/> ← 0 <input type="checkbox"/> ← 0 <input type="checkbox"/> ← 0	UFP Rd	-	-	-	-	-	-	-	Yes	-	-	UFP	Sink	N/A	UFP Only	Sink: PP_EXT	
14*	<input type="checkbox"/> ← 0 <input type="checkbox"/> ← 0 <input type="checkbox"/> ← 0 <input type="checkbox"/> ← 0	DFP Rp	3	-	-	-	-	-	-	-	-	-	DFP	Source	N/A	DFP Only	Source: PP_5V0 FET	
15	<input type="checkbox"/> ← 0 <input type="checkbox"/> ← 0 <input type="checkbox"/> ← 0 <input type="checkbox"/> ← 0	DRP Rpt/Rd	3	-	-	-	-	-	-	Yes	-	-	DRP	Sink/Source	N/A	DRP Only	Source: PP_5V0 FET Sink: PP_EXT	

* Configuration compatible with the TPS65986

NOTE: To achieve 5 A, an active or electronically marked cable is needed.

5.3.3.1 Configuration ID 0: Docking System

Table 3. Configuration ID 0

Config ID#	Switch S1	Port Type	Type-C Power	PD Source Capabilities			PD Sink Capabilities			Alternate Mode Support		PD Control	Application
				V	V	V	V	V	V	TBT Support	DP Support		
0	<ul style="list-style-type: none"> ■ ← 0 ■ ← 0 ■ ← 0 ■ ← 0 	DRP Rp/Rd	3	5 @ 3	12 @ 3	20 @ 5	5 @ 0	-	-	-	UFP_D Config C & D	Init DR Swap to UFP Init PR Swap to Src	Docking System

5.3.3.1.1 Overview

The TPS65982-EVM will power-on and initialize into configuration ID 0 when all 4 of the DIP switches [B0:B3] on switch bank S1 are pushed to the left-hand side. Configuration ID 0 is designed to model a docking system application.

A TPS65982-EVM configured as a dock is capable of providing (sourcing) power. The fully-featured Type-C port of a dock which faces a laptop can be an upstream-facing port (UFP) for DisplayPort video, which is also emulated by this EVM configuration. This configuration will also initiate a PD power role swap to source and/or a PD data role swap to UFP.

5.3.3.1.2 Source Capabilities

This configuration is capable of negotiating PD contracts to source 5 V at 3 A, 12 V at 3 A through the PP_HV internal FET path, and 20 V at 5 A through the PP_EXT external FET path.

5.3.3.1.3 Sink Capabilities

This configuration is capable of negotiating PD contracts to sink 5 V at 0 A.

5.3.3.1.4 Video Capabilities

This configuration is capable of negotiating a USB PD alternate mode contract for DisplayPort video as an upstream-facing port (UFP). An alternate mode contract will only be negotiated successfully when connected to a product which is capable of DisplayPort video as a downstream-facing port (DFP).

5.3.3.1.5 Ideal Connections

This configuration pairs ideally with a TPS65982-EVM using configuration ID 3 for providing power and entering DisplayPort alternate mode. This configuration is also compatible with a TPS65982-EVM using configuration ID 1 for providing power and entering DisplayPort alternate mode. These TPS65982-EVM configurations respectively emulate notebook, tablet, and charger-adapter applications and the same performance is expected when connected to actual applications of these products.

5.3.3.2 Configuration ID 1: Tablet (or Ultrabook)

Table 4. Configuration ID 1

Config ID#	Switch S1	Port Type	Type-C Power	PD Source Capabilities			PD Sink Capabilities			Alternate Mode Support		PD Control	Application
				Data Power	A	V @ A	V @ A	V @ A	V @ A	V @ A	V @ A		
1*	1→■ ■←0 ■←0 ■←0	DRP Rp/Rd	3	5 @ A	-	-	5 @ A	12-20 @ A	-	-	DFP_D Config C, D, & E	Init DR Swap to DFP Init PR Swap to Snk	Tablet/Ultrabook

5.3.3.2.1 Overview

The TPS65982-EVM will power-on and initialize into configuration ID 1 when the 1st DIP switch [B0] on switch bank S1 is pushed to the right-hand side and the 2nd (middle), 3rd, 4th DIP switches [B1], [B2], and [B3] on switch bank S1 are pushed to the left-hand side. Configuration ID 1 is designed to model a tablet (or Ultrabook) application.

A TPS65982-EVM configured as a tablet is capable of providing (sourcing) power or consuming (sinking) power. A fully-featured Type-C port on a tablet can be capable as a downstream-facing port (DFP) for DisplayPort video, which is also emulated by this EVM configuration. This configuration will also initiate a PD power role swap to sink and/or a PD data role swap to DFP.

5.3.3.2.2 Source Capabilities

This configuration is capable of negotiating PD contracts to source 5 V at 1.5 A only through the PP_5V0 internal FET path.

5.3.3.2.3 Sink Capabilities

This configuration is capable of negotiating PD contracts to sink 5 V at 3 A and 12 to 20 V at 3 A through the PP_HV internal FET path.

5.3.3.2.4 Video Capabilities

This configuration pairs ideally with a TPS65982-EVM using configuration ID 0 for consuming or providing power and entering DisplayPort alternate mode. This configuration is also compatible with a TPS65982-EVM using configuration ID 4 for providing power and entering DisplayPort alternate mode. To test this configuration as a power consumer which enters USB2.0 and 3.1 for data, pair it with a TPS65982-EVM using configuration ID 6. These TPS65982-EVM configurations respectively emulate dock, dongle, and charger-adapter applications and the same performance is expected when connected to actual applications of these products.

5.3.3.2.5 Ideal Connections

This configuration pairs ideally with a TPS65982-EVM using configuration ID 0 for consuming power and entering DisplayPort alternate mode. This configuration is also compatible with a TPS65982-EVM using configuration ID 4 for providing power and entering DisplayPort alternate mode. These TPS65982-EVM configurations respectively emulate dock, dongle, and charger-adapter applications and the same performance is expected when connected to actual applications of these products.

5.3.3.3 Configuration ID 2: Notebook (or Mobile Workstation) with Thunderbolt Mode Capabilities

Table 5. Configuration ID 2

Config ID#	Switch S1	Port Type	Type-C Power	PD Source Capabilities			PD Sink Capabilities			Alternate Mode Support		PD Control	Application
				Data Power	V @ A	V @ A	V @ A	V @ A	V @ A	V @ A	TBT Support		
2	<ul style="list-style-type: none"> ■←0 1→■ ■←0 ■←0 	DRP Rp/Rd	3	5 @ 3	12 @ 3	-	5 @ 0	20 @ 3	-	Yes	DFP_D Config C, D, & E	Init DR Swap to DFP Init PR Swap to Snk	Thunderbolt Notebook

5.3.3.3.1 Overview

The TPS65982-EVM will power-on and initialize into configuration ID 2 when the 1st, 3rd, and 4th DIP switches [B0],[B2], [B3] on switch bank S1 are pushed to the left-hand side and the 2nd DIP switch [B1] on switch bank S1 is pushed to the right-hand side. Configuration ID 2 is designed to model a Thunderbolt notebook (or mobile workstation) application.

A TPS65982-EVM configured as a notebook is capable of providing (sourcing) power or consuming (sinking) power. A fully-featured Type-C port on a notebook can be capable as a downstream-facing port (DFP) for DisplayPort video and Thunderbolt Alternate Mode video+data, which is also emulated by this EVM configuration. This configuration will also initiate a PD power role swap to sink and/or a PD data role swap to DFP.

5.3.3.3.2 Source Capabilities

This configuration is capable of negotiating PD contracts to source 5 V at 3 A through the PP_5V0 internal FET path and 12 V at 3 A through the PP_HV internal FET path.

5.3.3.3.3 Sink Capabilities

This configuration is capable of negotiating PD contracts to sink 5 V at 0 A and 20 V at 3 A through the PP_EXT external FET path.

5.3.3.3.4 Video Capabilities

This configuration is capable of negotiating a USB PD Thunderbolt Alternate Mode contract for video+data as a downstream-facing port (DFP). This configuration is also capable of negotiating a USB PD alternate mode contract for DisplayPort video as a downstream-facing port (DFP). An alternate mode contract will only be negotiated successfully when connected to a product which is capable of Thunderbolt Alternate Mode or DisplayPort video as an upstream-facing port (UFP).

5.3.3.3.5 Ideal Connections

This configuration pairs ideally with a TPS65982-EVM using configuration ID 5 for consuming or providing power and entering Thunderbolt Alternate Mode. This configuration is also compatible with a TPS65982-EVM using configuration ID 4 for providing power and entering DisplayPort alternate mode. To test this configuration as a power consumer which enters USB2.0 and 3.1 for data, pair it with a TPS65982-EVM using configuration ID 6. These TPS65982-EVM configurations respectively emulate dock, dongle, and charger-adaptor applications and the same performance is expected when connected to actual applications of these products.

5.3.3.4 Configuration ID 3: Notebook (or Mobile Workstation) That can Pass AC-Adapted Power

Table 6. Configuration ID 3

Config ID#	Switch S1	Port Type	Type-C Power	PD Source Capabilities			PD Sink Capabilities			Alternate Mode Support		PD Control	Application
				V	V	V	V	V	V	TBT Support	DP Support		
		Data Power	A	@ A	@ A	@ A	@ A	@ A	@ A				
3	1→■ 1→■ ■←0 ■←0	DRP Rp/Rd	3	5 @ 3	20 @ 3	-	5 @ 0	20 @ 3	-	-	DFP_D Config C, D, & E	Init DR Swap to DFP Init PR Swap to Snk	Notebook, Mobile Workstation

5.3.3.4.1 Overview

The TPS65982-EVM will boot up and initialize into configuration ID 3 when the 1st and 2nd DIP switches [B0] and [B1] on switch bank S1 are pushed to the right-hand side and the 3rd and 4th DIP switch [B2] and [B3] on switch bank S1 is pushed to the left-hand side. Configuration ID 3 is designed to model a notebook (or mobile workstation) application that can pass AC-adapted power as a provider.

A TPS65982-EVM configured as a notebook is capable of providing (sourcing) power or consuming (sinking) power. A fully-featured Type-C port on a notebook can be capable as a downstream-facing port (DFP) for DisplayPort video, which is also emulated by this EVM configuration. This configuration will also initiate a PD power role swap to sink and/or a PD data role swap to DFP.

5.3.3.4.2 Source Capabilities

This configuration is capable of negotiating PD contracts to source 5 V at 3 A through the PP_5V0 internal FET path and 20 V at 3 A through the PP_EXT external FET path.

5.3.3.4.3 Sink Capabilities

This configuration is capable of negotiating PD contracts to sink 5 V at 0 A and 20 V at 3 A through the PP_HV internal FET path.

5.3.3.4.4 Video Capabilities

This configuration is capable of negotiating a USB PD alternate mode contract for DisplayPort video as a downstream-facing port (DFP). An alternate mode contract will only be negotiated successfully when connected to a product which is capable of DisplayPort video as an upstream-facing port (UFP).

5.3.3.4.5 Ideal Connections

This configuration pairs ideally with a TPS65982-EVM using configuration ID 0 for consuming or providing power and entering DisplayPort alternate mode. This configuration is also compatible with a TPS65982-EVM using configuration ID 4 for providing power and entering DisplayPort alternate mode. To test this configuration as a power consumer which enters USB2.0 and 3.1 for data, pair it with a TPS65982-EVM using configuration ID 6. These TPS65982-EVM configurations respectively emulate dock, dongle, and charger-adaptor applications and the same performance is expected when connected to actual applications of these products.

5.3.3.5 Configuration ID 4: Dongle

Table 7. Configuration ID 4

Config ID#	Switch S1	Port Type	Type-C Power	PD Source Capabilities			PD Sink Capabilities			Alternate Mode Support		PD Control	Application
				Data Power	A	V @ A	V @ A	V @ A	V @ A	V @ A	V @ A		
4*	<ul style="list-style-type: none"> ■←0 ■←0 1→■ ■←0 	UFP Rd	-	-	-	-	5 @ 900mA	-	-	-	UFP_D Config E	N/A	DP Dongle

5.3.3.5.1 Overview

The TPS65982-EVM will boot up and initialize into configuration ID 4 when the 1st, 2nd, and 4th DIP switches [B0], [B1], and [B3] on switch bank S1 are pushed to the left-hand side and the 3rd DIP switch [B2] on switch bank S1 is pushed to the right-hand side. Configuration ID 4 is designed to model a dongle application.

A TPS65982-EVM configured as a dongle is capable of consuming (sinking) power only. A fully-featured Type-C port on a dongle can be capable as an upstream-facing port (UFP) for DisplayPort video, which is also emulated by this EVM configuration.

5.3.3.5.2 Source Capabilities

This configuration is designed to be a consumer (sink) of power only, and therefore does not have any source capabilities.

5.3.3.5.3 Sink Capabilities

This configuration is capable of negotiating PD contracts to sink 5 V at 900 milliamps through the PP_HV internal FET path only.

5.3.3.5.4 Video Capabilities

This configuration is capable of negotiating a USB PD alternate mode contract for DisplayPort video as an upstream-facing port (UFP). An alternate mode contract will only be negotiated successfully when connected to a product which is capable of DisplayPort video as a downstream-facing port (DFP).

5.3.3.5.5 Ideal Connections

This configuration pairs ideally with a TPS65982-EVM using configuration ID 3 for consuming power and entering DisplayPort alternate mode. This configuration is also compatible with a TPS65982-EVM using configuration ID 1 for consuming power and entering DisplayPort alternate mode. These TPS65982-EVM configurations respectively emulate notebook and tablet/Ultrabook applications and the same performance is expected when connected to actual applications of these products.

5.3.3.6 Configuration ID 5: Docking System with Thunderbolt Mode Capabilities

Table 8. Configuration ID 5

Config ID#	Switch S1	Port Type	Type-C Power	PD Source Capabilities			PD Sink Capabilities			Alternate Mode Support		PD Control	Application
				V	V	V	V	V	V	TBT Support	DP Support		
		Data Power	A	@ A	@ A	@ A	@ A	@ A	@ A				
5	1→■ ■←0 1→■ ■←0	DRP Rp/Rd	3	5 @ 3	12 @ 3	20 @ 5	5 @ 0	-	-	Yes	DFP_D Config C, D, & E	Init PR Swap to Src	Thunderbolt Docking System

5.3.3.6.1 Overview

The TPS65982-EVM will boot up and initialize into configuration ID 5 when the 1st and 3rd DIP switches [B0] and [B2] on switch bank S1 are pushed to the right-hand side and the 2nd, and 4th DIP switches [B1] and [B3] on switch bank S1 is pushed to the left-hand side. Configuration ID 5 is designed to model a Thunderbolt docking system application.

A TPS65982-EVM configured as a dock is capable of providing (sourcing) power. The fully-featured Type-C port of a dock which faces a monitor can be a downstream-facing port (DFP) for DisplayPort video and Thunderbolt Alternate Mode video+data, which is also emulated by this EVM configuration. This configuration will initiate a PD power role swap to source.

5.3.3.6.2 Source Capabilities

This configuration is capable of negotiating PD contracts to source 5 V at 3 A through the PP_5V0 internal FET path, 12 V at 3 A through the PP_HV internal FET path, and 20 V at 5 A through the PP_EXT external FET path.

5.3.3.6.3 Sink Capabilities

This configuration is capable of negotiating a PD contract to sink 5 V at 0 A.

5.3.3.6.4 Video Capabilities

This configuration is capable of negotiating a USB PD Thunderbolt Alternate Mode contract for video+data as a downstream-facing port (DFP). This configuration is also capable of negotiating a USB PD alternate mode contract for DisplayPort video as a downstream-facing port (DFP). An alternate mode contract will only be negotiated successfully when connected to a product which is capable of Thunderbolt Alternate Mode or DisplayPort video as an upstream-facing port (UFP).

5.3.3.6.5 Ideal Connections

This configuration pairs ideally with a TPS65982-EVM using configuration ID 2 for providing power and entering Thunderbolt Alternate Mode for video+data. This configuration is also compatible with a TPS65982-EVM using configuration ID 4 entering DisplayPort alternate mode. These TPS65982-EVM configurations respectively emulate notebook and charger-adaptor applications and the same performance is expected when connected to actual applications of these products.

5.3.3.7 Configuration ID 6: Charger-Adapter (or AC Adapter)

Table 9. Configuration ID 6

Config ID#	Switch S1	Port Type	Type-C Power	PD Source Capabilities			PD Sink Capabilities			Alternate Mode Support		PD Control	Application
				Data Power	A	V @ A	V @ A	V @ A	V @ A	V @ A	V @ A		
6	<ul style="list-style-type: none"> ■←0 1→■ 1→■ ■←0 	DFF Rp	3	5 @ 3	12 @ 3	20 @ 5	-	-	-	-	-	N/A	High Power Charger Adapter

5.3.3.7.1 Overview

The TPS65982-EVM will boot up and initialize into configuration ID 6 when the 1st and 4th DIP switches [B0] and [B3] on switch bank S1 is pushed to the left-hand side and the 2nd and 3rd DIP switches [B1] and [B2] on switch bank S1 are pushed to the right-hand side. Configuration ID 6 is designed to model a charger-adapter application.

A TPS65982-EVM configured as a charger is capable of providing (sourcing) power only. A fully-featured Type-C port on a charger can be capable of USB 2.0 and USB3.1 data, which is also emulated by this EVM configuration.

5.3.3.7.2 Source Capabilities

This configuration is capable of negotiating PD contracts to source 5 V at 3 A through the PP_5V0 internal FET path, 12 V at 3 A through the PP_HV internal FET path, and 20 V at 0 A through the PP_EXT external FET path.

5.3.3.7.3 Sink Capabilities

This configuration is designed to be a provider (source) of power only, and therefore does not have any sink capabilities.

5.3.3.7.4 Video Capabilities

This configuration is capable of USB 2.0 and USB 3.1 data only, and therefore does not have any video capabilities.

5.3.3.7.5 Ideal Connections

This configuration pairs ideally with a TPS65982-EVM using configuration ID 7 for providing power and enters USB2.0 and 3.1 mode for data by default. This configuration is also compatible with a TPS65982-EVM using configuration ID 2 or 3 for providing power and enters USB2.0 and 3.1 mode for data by default. This configuration is also compatible with a TPS65982-EVM using configuration ID 2 for providing power and enters USB2.0 and 3.1 mode for data by default. This configuration is also compatible with a TPS65982-EVM using configuration ID 1 for providing power and enters USB2.0 and 3.1 mode for data by default. These TPS65982-EVM configurations respectively emulate high-power bus-powered device, notebook, dock, and tablet applications and the same performance is expected when connected to actual applications of these products.

5.3.3.8 Configuration ID 7: High-Power Bus-Powered Device

Table 10. Configuration ID 7

Config ID#	Switch S1	Port Type	Type-C Power	PD Source Capabilities			PD Sink Capabilities			Alternate Mode Support		PD Control	Application
				Data Power	A	V @ A	V @ A	V @ A	V @ A	V @ A	V @ A		
7	1→■	UFP Rd	-	-	-	-	5V @ 3	12V @ 3	20V @ 5	-	-	N/A	High Power Bus Powered Device
	1→■												
	1→■												
	■←0												

5.3.3.8.1 Overview

The TPS65982-EVM will boot up and initialize into configuration ID 7 when [B0], [B1], and [B2] of the DIP switches on switch bank S1 are pushed to the right-hand side and [B3] is pushed to the left. Configuration ID 7 is designed to model a high-power bus-powered device application.

A TPS65982-EVM configured as a high-power bus-powered device is capable of consuming (sinking) power only. A fully-featured Type-C port on a high-power bus-powered device can be capable of USB 2.0 and USB3.1 data, which is also emulated by this EVM configuration.

5.3.3.8.2 Source Capabilities

This configuration is designed to be a consumer (sink) of power only, and therefore does not have any source capabilities.

5.3.3.8.3 Sink Capabilities

This configuration is capable of negotiating PD contracts to sink 5 V at 3 A, 12 V at 3 A, 20 V at 5 A through the PP_EXT external FET path.

5.3.3.8.4 Video Capabilities

This configuration is capable of USB 2.0 and USB 3.1 data only, and therefore does not have any video capabilities.

5.3.3.8.5 Ideal Connections

This configuration pairs ideally with a TPS65982-EVM using configuration ID 6 for consuming power and enters USB2.0 and 3.1 mode for data by default. This configuration is also compatible with a TPS65982-EVM using configuration ID 0 or 5 for consuming power and entering USB2.0 and 3.1 mode for data by default. This configuration is also compatible with a TPS65982-EVM using configuration ID 2 or 3 for consuming power and entering USB2.0 and 3.1 mode for data by default. These TPS65982-EVM configurations respectively emulate charger-adapter, dock, and notebook applications and the same performance is expected when connected to actual applications of these products.

5.3.3.9 Configuration ID 8: Thunderbolt Desktop/Add-in Card

Table 11. Configuration ID 8

Config ID#	Switch S1	Port Type	Type-C Power	PD Source Capabilities			PD Sink Capabilities			Alternate Mode Support		PD Control	Application
				V	V	V	V	V	V	TBT Support	DP Support		
8	<ul style="list-style-type: none"> ■←0 ■←0 ■←0 1→■ 	DFP Rp	3	5 @ A	12 @ A	-	5 @ A	-	-	Yes	DFP_DP Config C, D, & E	N/A	Thunderbolt Desktop, Add-in Card

5.3.3.9.1 Overview

The TPS65982-EVM will boot up and initialize into configuration ID 8 when the switches [B0], [B1], and [B2] on switch bank S1 are pushed to the left-hand side and switch [B3] on switch bank S1 is pushed to the right-hand side. Configuration ID 8 is designed to model a Thunderbolt Desktop/Add-in Card application.

A TPS65982-EVM configured as a desktop is capable of providing (sourcing) power. The fully-featured Type-C port can be a downstream-facing port (DFP) for DisplayPort video and Thunderbolt Alternate Mode video+data, which is also emulated by this EVM configuration.

5.3.3.9.2 Source Capabilities

This configuration is capable of negotiating PD contracts to source 5 V at 3 A through the PP_5V0 internal FET path and 12 V at 3 A through the PP_HV internal FET path.

5.3.3.9.3 Sink Capabilities

This configuration is capable of negotiating a PD contract to sink 5 V at 0 A.

5.3.3.9.4 Video Capabilities

This configuration is capable of negotiating a USB PD Thunderbolt Alternate Mode contract for video+data as a downstream-facing port (DFP). This configuration is also capable of negotiating a USB PD alternate mode contract for DisplayPort video as a downstream-facing port (DFP). An alternate mode contract will only be negotiated successfully when connected to a product which is capable of Thunderbolt Alternate Mode or DisplayPort video as an upstream-facing port (UFP).

5.3.3.9.5 Ideal Connections

This configuration pairs ideally with a TPS65982-EVM using configuration ID 2 for providing power and entering Thunderbolt Alternate Mode for video+data. This configuration is also compatible with a TPS65982-EVM using configuration ID 4 for providing power and entering DisplayPort alternate mode.

5.3.3.10 Configuration ID 9: Desktop/Add-in Card

Table 12. Configuration ID 9

Config ID#	Switch S1	Port Type	Type-C Power	PD Source Capabilities			PD Sink Capabilities			Alternate Mode Support		PD Control	Application
				V	V	V	V	V	V	TBT Support	DP Support		
		Data Power	A	@ A	@ A	@ A	@ A	@ A	@ A				
9*	1→■ ■←0 ■←0 1→■	DFP Rp	3	5 @ 3	12 @ 3		5 @ 0	-	-	-	DFP_D Config C, D, & E	N/A	Desktop, Add-in Card

5.3.3.10.1 Overview

The TPS65982-EVM will boot up and initialize into configuration ID 9 when [B0] and [B3] DIP switches on S1 are pushed to the right-hand side and switch [B1] and [B2] on switch bank S1 is pushed to the left-hand side. Configuration ID 9 is designed to model a desktop application.

A TPS65982-EVM configured as a desktop is capable of providing (sourcing) power. A fully-featured Type-C port on a desktop can be capable as a downstream-facing port (DFP) for DisplayPort video, which is also emulated by this EVM configuration.

5.3.3.10.2 Source Capabilities

This configuration is capable of negotiating PD contracts to source 5 V at 3 A through the PP_5V0 internal FET path and 12 V at 3 A through the PP_HV internal FET path.

5.3.3.10.3 Sink Capabilities

This configuration is capable of negotiating PD contracts to sink 5 V at 0 A and 20 V at 3 A through the PP_HV internal FET path.

5.3.3.10.4 Video Capabilities

This configuration is capable of negotiating a USB PD alternate mode contract for DisplayPort video as a downstream-facing port (DFP). An alternate mode contract will only be negotiated successfully when connected to a product which is capable of DisplayPort video as an upstream-facing port (UFP).

5.3.3.10.5 Ideal Connections

This configuration pairs ideally with a TPS65982-EVM using configuration ID 11 for providing power and entering DisplayPort alternate mode. This configuration is also compatible with a TPS65982-EVM using configuration ID 4 for providing power and entering DisplayPort alternate mode.

5.3.3.11 Configuration ID 10: Thunderbolt Bus-Powered Device

Table 13. Configuration ID 10

Config ID#	Switch S1	Port Type	Type-C Power	PD Source Capabilities			PD Sink Capabilities			Alternate Mode Support		PD Control	Application
				Data Power	A	V @ A	V @ A	V @ A	V @ A	V @ A	V @ A		
10	■←0	UFP Rd	-	-	-	-	5V @ 3	12V @ 1.2	20V @ .75	Yes	-	N/A	Thunderbolt Bus-Powered Device
	1→■												
	■←0												
	1→■												

5.3.3.11.1 Overview

The TPS65982-EVM will boot up and initialize into configuration ID 10 when the DIP switches [B1] and [B3] on switch bank S1 are pushed to the right-hand side and [B0] and [B2] on switch bank S1 is pushed to the left-hand side. Configuration ID 10 is designed to model Thunderbolt Bus Powered Device.

A TPS65982-EVM configured as a Thunderbolt device is able to enter the Thunderbolt alternate mode.

5.3.3.11.2 Source Capabilities

This configuration is not capable of providing power.

5.3.3.11.3 Sink Capabilities

This configuration is capable of negotiating a PD contract to sink 5 V at 3 A, 12 V at 1.2 A, and 20 V at 0.75 A.

5.3.3.11.4 Video Capabilities

This configuration is capable of negotiating a USB PD Thunderbolt Alternate Mode contract for video+data.

5.3.3.11.5 Ideal Connections

This configuration pairs ideally with a TPS65982-EVM using configuration ID 2 and 8 to enter the Thunderbolt alternate mode.

5.3.3.12 Configuration ID 11: Mini-Docking System

Table 14. Configuration ID 11

Config ID#	Switch S1	Port Type	Type-C Power	PD Source Capabilities			PD Sink Capabilities			Alternate Mode Support		PD Control	Application
				V @ A	V @ A	V @ A	V @ A	V @ A	V @ A	TBT Support	DP Support		
11	1→■ 1→■ ■←0 1→■	DRP Rp/Rd	3	5 @ 3	20 @ 3	-	5 @ 1.5	20V @ 3	-	-	UFP_D Config D	Init DR Swap to UFP Init PR Swap to Src	Mini-Dock System

5.3.3.12.1 Overview

The TPS65982-EVM will power-on and initialize into configuration ID 11 when [B0], [B1] and [B3] on switch bank S1 are pushed to the right-hand side and [B2] is pushed to the left. Configuration ID 11 is designed to model a docking system application.

A TPS65982-EVM configured as a dock is capable of providing (sourcing) power and consuming (sinking) power. The fully-featured Type-C port of a dock which faces a laptop can be an upstream-facing port (UFP) for DisplayPort video, which is also emulated by this EVM configuration. This configuration will also initiate a PD power role swap to source and/or a PD data role swap to UFP.

5.3.3.12.2 Source Capabilities

This configuration is capable of negotiating PD contracts to source 5 V at 3 A, and 20 V at 3 A through the PP_EXT external FET path.

5.3.3.12.3 Sink Capabilities

This configuration is capable of negotiating PD contracts to sink 5 V at 1.5 A and 20 V at 3 A

5.3.3.12.4 Video Capabilities

This configuration is capable of negotiating a USB PD alternate mode contract for DisplayPort video as an upstream-facing port (UFP). An alternate mode contract will only be negotiated successfully when connected to a product which is capable of DisplayPort video as a downstream-facing port (DFP).

5.3.3.12.5 Ideal Connections

This configuration pairs ideally with a TPS65982-EVM using configuration ID 1 for consuming or providing power and entering DisplayPort alternate mode. When acting as a bus-powered dock connecting to configuration ID 3 will power the dock from bus-power and will negotiate DisplayPort alternate mode.

5.3.3.13 Configuration ID 12: Mid-Power Charger Adapter

Table 15. Configuration ID 12

Config ID#	Switch S1	Port Type	Type-C Power	PD Source Capabilities			PD Sink Capabilities			Alternate Mode Support		PD Control	Application
				Data Power	A	V @ A	V @ A	V @ A	V @ A	V @ A	V @ A		
12*	<ul style="list-style-type: none"> ■←0 ■←0 1→■ 1→■ 	DFP Rp	3	5 @ 3	12 @ 3	-	-	-	-	-	-	N/A	Mid Power Charger Adapter

5.3.3.13.1 Overview

The TPS65982-EVM will boot up and initialize into configuration ID 12 when [B0] and [B1] on switch bank S1 is pushed to the left-hand side and [B2] and [B3] on switch bank S1 is pushed to the right-hand side. Configuration ID 12 is designed to model a charger-adapter application.

A TPS65982-EVM configured as a charger is capable of providing (sourcing) power only. A fully-featured Type-C port on a charger can be capable of USB 2.0 and USB3.1 data, which is also emulated by this EVM configuration.

5.3.3.13.2 Source Capabilities

This configuration is capable of negotiating PD contracts to source 5 V at 3 A through the PP_5V0 internal FET path, 12 V at 3 A through the PP_HV internal FET path

5.3.3.13.3 Sink Capabilities

This configuration is designed to be a provider (source) of power only, and therefore does not have any sink capabilities.

5.3.3.13.4 Video Capabilities

This configuration is capable of USB 2.0 and USB 3.1 data only, and therefore does not have any video capabilities.

5.3.3.13.5 Ideal Connections

This configuration pairs ideally with a TPS65982-EVM using configuration ID 7 for providing power and enters USB2.0 and 3.1 mode for data by default. This configuration can be used with any of the other configurations which are capable of sinking power.

5.3.3.14 Configuration ID 13: Type-C UFP Only

Table 16. Configuration ID 13

Config ID#	Switch S1	Port Type	Type-C Power	PD Source Capabilities			PD Sink Capabilities			Alternate Mode Support		PD Control Initiated DR/PR Swaps	Application
				Data Power	A	V @ A	V @ A	V @ A	V @ A	V @ A	V @ A		
13	1→■ ■←0 1→■ 1→■	UFP Rd	-	-	-	-	-	-	-	-	-	N/A	UFP Only

5.3.3.14.1 Overview

The TPS65982-EVM will boot up and initialize into configuration ID 13 when [B1] on switch bank S1 is pushed to the left-hand side and [B0], [B2], and [B3] on switch bank S1 is pushed to the right-hand side. Configuration ID 13 is designed to model Type-C UFP only device.

5.3.3.14.2 Source Capabilities

This configuration is capable not capable of providing power.

5.3.3.14.3 Sink Capabilities

This configuration is designed to only sink Type-C power (5 V).

5.3.3.15 Configuration ID 14: Type-C DFP Only

Table 17. Configuration ID 14

Config ID#	Switch S1	Port Type	Type-C Power	PD Source Capabilities			PD Sink Capabilities			Alternate Mode Support		PD Control Initiated DR/PR Swaps	Application
				Data Power	A	V @ A	V @ A	V @ A	V @ A	V @ A	V @ A		
14*	■←0 1→■ 1→■ 1→■	DFP Rp	3	-	-	-	-	-	-	-	-	N/A	DFP Only

5.3.3.15.1 Overview

The TPS65982-EVM will boot up and initialize into configuration ID 14 when [B0] on switch bank S1 is pushed to the left-hand side and [B1], [B2], and [B3] on switch bank S1 is pushed to the right-hand side. Configuration ID 14 is designed to model Type-C DFP only device.

5.3.3.15.2 Source Capabilities

This configuration is capable of providing Type-C power (5 V at 3 A).

5.3.3.15.3 Sink Capabilities

This configuration is not capable of sinking power

5.3.3.16 Configuration ID 15: Type-C DRP Only

Table 18. Configuration ID 15

Config ID#	Switch S1	Port Type	Type-C Power	PD Source Capabilities			PD Sink Capabilities			Alternate Mode Support		PD Control	Application
				V @ A	V @ A	V @ A	V @ A	V @ A	V @ A	TBT Support	DP Support		
15	1→■ 1→■ 1→■ 1→■	DRP Rp/Rd	3	-	-	-	-	-	-	-	-	N/A	DRP Only

5.3.3.16.1 Overview

The TPS65982-EVM will boot up and initialize into configuration ID 15 when [B0], [B1], [B2], and [B3] on switch bank S1 are pushed to the right-hand side. Configuration ID 15 is designed to model Type-C DRP only device.

5.3.3.16.2 Source Capabilities

This configuration is capable of providing Type-C power (5 V at 3 A).

5.3.3.16.3 Sink Capabilities

This configuration is designed to only sink Type-C power (5 V).

6 Schematic

The circuit diagram in Figure 3 shows the schematic for page 1 of the TPS65982-EVM. Page 1 includes the TPS65982 IC (U2), the USB Type-C receptacle (J1), the SPI Flash memory IC (U1), the ESD ICs (U3 and U4), the switch banks (S1 and S2), the Tiva LaunchPad receptacles (J2 and J3), the External FETs for 5-A delivery (Q1 and Q2), the LEDs (D2–D8) and driving FETs (Q3–Q8, Q13–Q15), and necessary passive circuitry for the TPS65982.

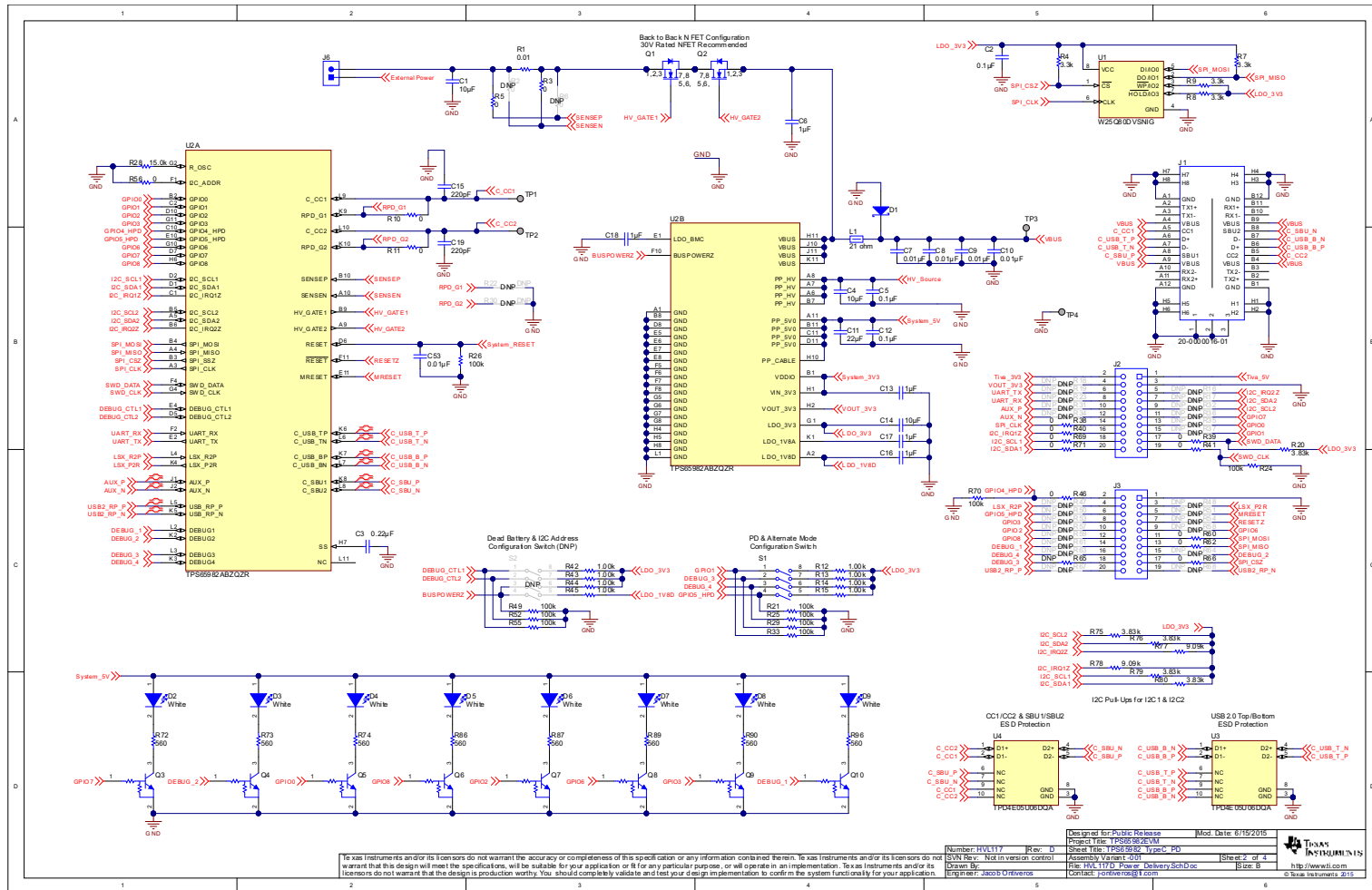
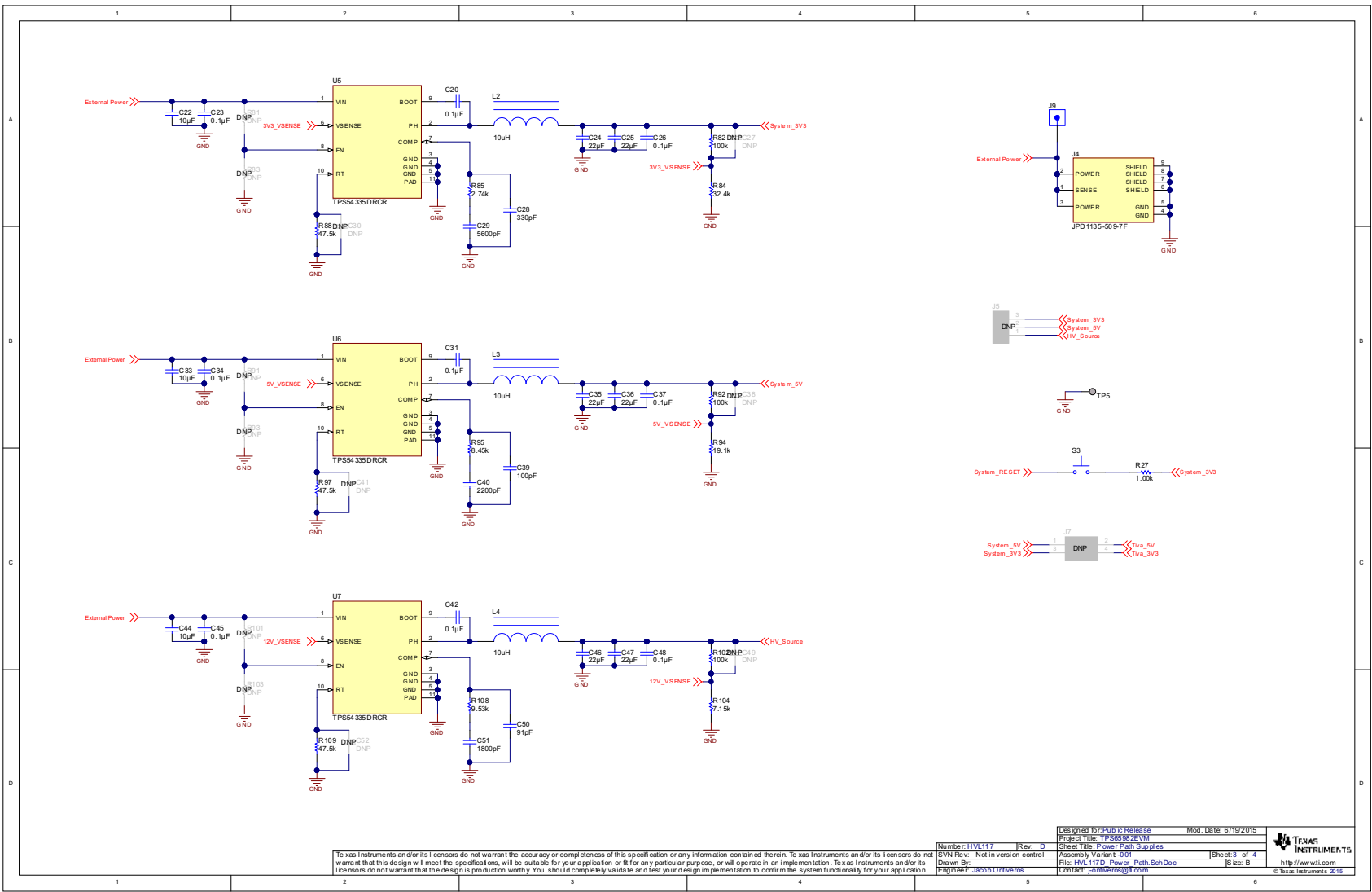

Figure 3. TPS65982-EVM Schematic Page 1

The circuit diagram in Figure 4 shows the schematic for page 2 of the TPS65982-EVM. Page 2 includes power path-related ICs: the External_Power to System_3V3 buck converter (U5) and passive components, the External_Power to System_5V buck converter (U6) and passive components, the External_Power to HV_Source buck converter (U7) and passive components, the Barrel Jack receptacle (J4), the power rail header (J5), the Tiva to System power jumper (J7), and the System_RESET push-button (S3).



Texas Instruments and/or its licensors do not warrant the accuracy or completeness of this specification or any information contained therein. Texas Instruments and/or its licensors do not warrant that this design will meet the specifications, will be suitable for your application or fit for any particular purpose, or will operate in an implementation. Texas Instruments and/or its licensors do not warrant that the design is production worthy. You should completely validate and test your design implementation to confirm the system functionality for your application.

Designed By: PAJ/C Release	Mod. Date: 6/19/2015	 TEXAS INSTRUMENTS http://www.ti.com © Texas Instruments 2015
Project Title: TPS65982EVM	Sheet Title: Power Path Supplies	
Number: HV1177 [Rev. 0]	Assembly Variant: 001	
SVN Rev.: Not in version control	Sheet: 3 of 4	
Drawn By:	File: HV1177D_Power_Path_Sch.Doc	Site: B
Engineer: Jisob/Ontwrens	Contact: pontwrens@ti.com	

Figure 4. TPS65982-EVM Schematic Page 2

7 Board Layout

Figure 5 through Figure 12 illustrate the PCB layouts of this EVM.

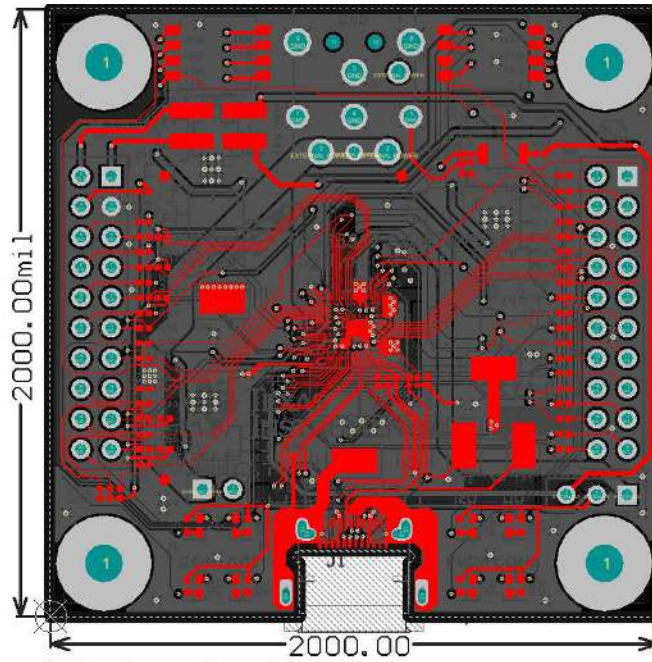

Figure 5. PCB Layer 1 (Top Layer)

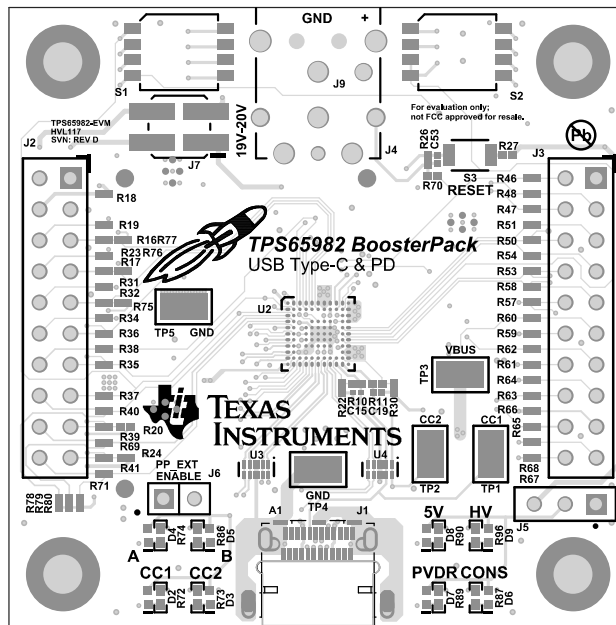

Figure 6. PCB Layer 1 (Component View)

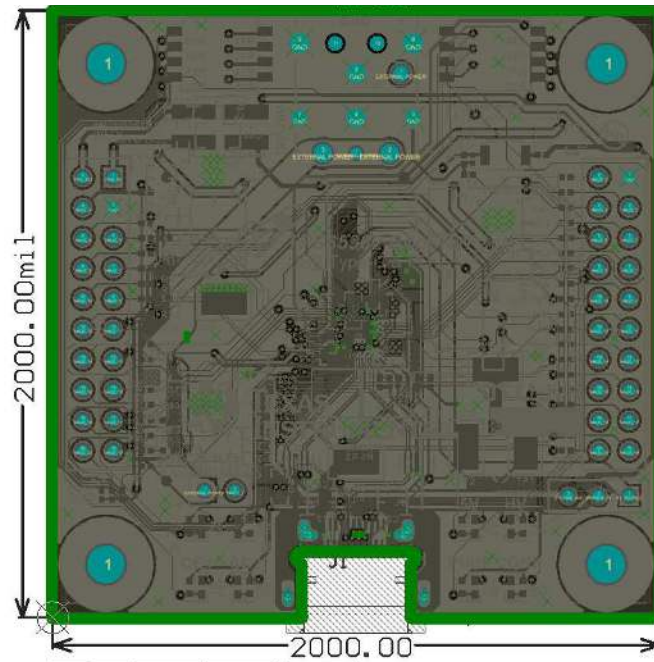

Figure 7. PCB Layer 2 (GND Plane)

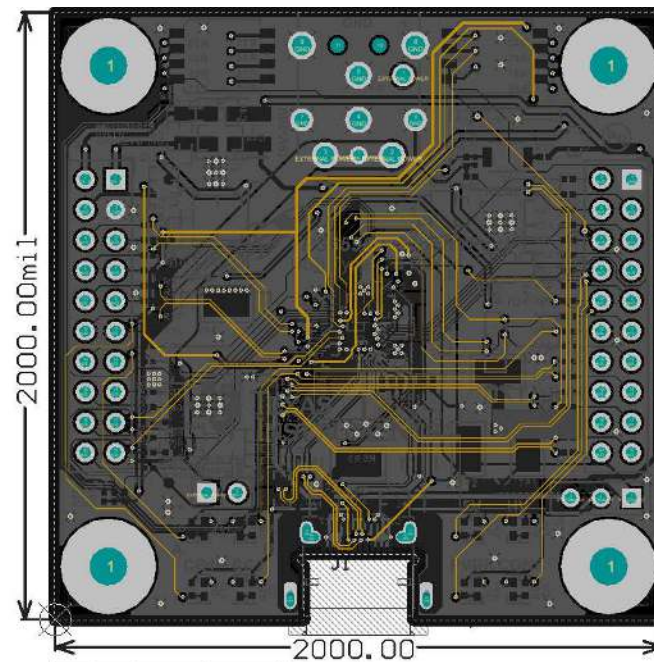

Figure 8. PCB Layer 3 (Inner Signal Layer 1)

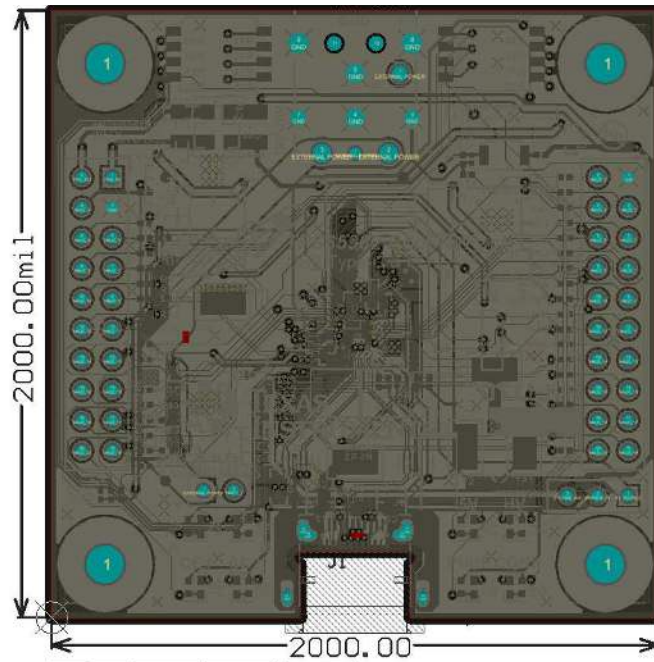

Figure 9. PCB Layer 4 (GND Plane)

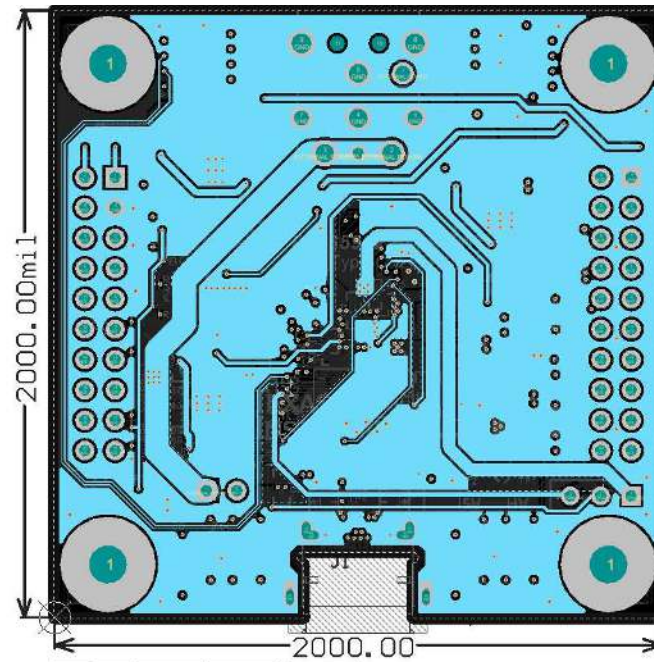

Figure 10. PCB Layer 5 (Inner Signal Layer 2)

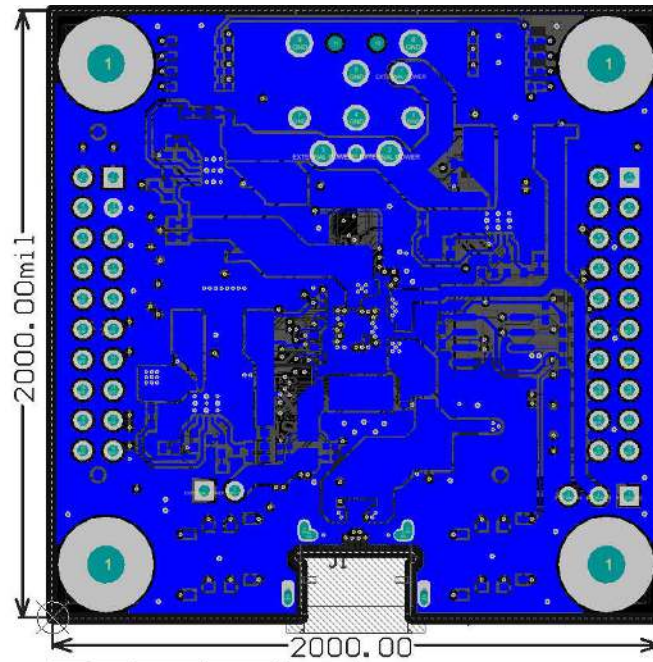

Figure 11. PCB Layer 6 (Bottom Layer)

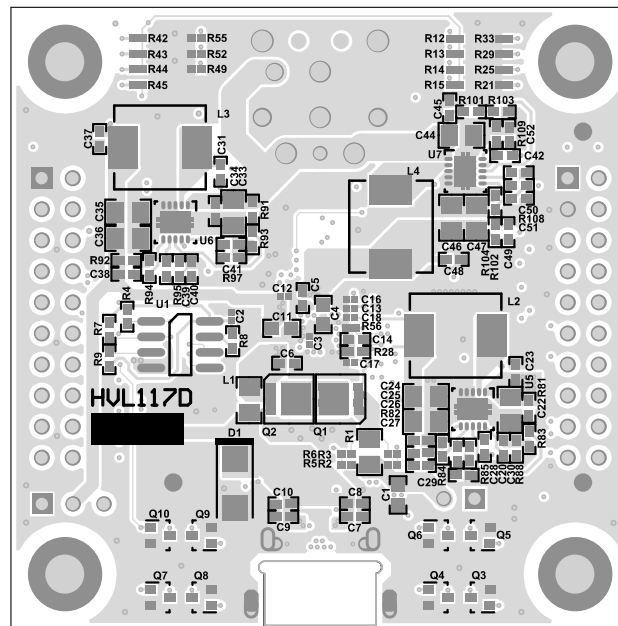

Figure 12. PCB Layer 6 (Component View)

8 Bill of Materials

Table 19 lists the EVM BOM.

Table 19. Bill of Materials

Item #	Designator	Quantity	Value	PartNumber	Manufacturer	Description	PackageReference
1	!PCB1	1		HVL117D	Any	Printed Circuit Board	
2	C1, C4	2	10uF	GRM188R61E106MA73	MuRata	CAP, CERM, 10 µF, 25 V, +/- 20%, X5R, 0603	0603
3	C2, C12	2	0.1uF	CL03A104KP3NNNC	Samsung	CAP, CERM, 0.1 µF, 10 V, +/- 10%, X5R, 0201	0201
4	C3	1	0.22uF	GRM033R60J224ME90	MuRata	CAP, CERM, 0.22 µF, 6.3 V, +/- 20%, X5R, 0201	0201
5	C5	1	0.1uF	C1005X7R1H104M	TDK	CAP, CERM, 0.1 µF, 50 V, +/- 20%, C0G/NP0, 0402	0402
6	C6	1	1uF	C1005JB1V105K050BC	TDK	CAP, CERM, 1 µF, 35 V, +/- 10%, JB, 0402	0402
7	C7, C8, C9, C10	4	0.01uF	GRM155R71H103KA88D	MuRata	CAP, CERM, 0.01 µF, 50 V, +/- 10%, X7R, 0402	0402
8	C11	1	22uF	GRM188R61A226ME15D	MuRata	CAP, CERM, 22 µF, 10 V, +/- 20%, X5R, 0603	0603
9	C13, C16, C17, C18	4	1uF	CL03A105MP3NSNC	Samsung	CAP, CERM, 1 µF, 10 V, +/- 20%, X5R, 0201	0201
10	C14	1	10uF	CL05A106MP5NUNC	Samsung	CAP, CERM, 10 µF, 10 V, +/- 20%, X5R, 0402	0402
11	C15, C19	2	220pF	GRM033R71E221KA01D	MuRata	CAP, CERM, 220 pF, 25 V, +/- 10%, X7R, 0201	0201
12	C20, C23, C26, C31, C34, C37, C42, C45, C48	9	0.1uF	C1005X7R1H104M	TDK	CAP, CERM, 0.1uF, 50V, +/-20%, C0G/NP0, 0402	0402
13	C22, C33, C44	3	10uF	C2012X5R1E106K125AB	TDK	CAP, CERM, 10 µF, 25 V, +/- 10%, X5R, 0805	0805
14	C24, C25, C35, C36, C46, C47	6	22uF	C2012X5R1V226M125AC	TDK	CAP, CERM, 22 µF, 35 V, +/- 20%, X5R, 0805	0805
15	C28	1	330pF	C1005C0G1H331J	TDK	CAP, CERM, 330 pF, 50 V, +/- 5%, C0G/NP0, 0402	0402
16	C29	1	5600pF	GRM155R71H562KA88D	MuRata	CAP, CERM, 5600 pF, 50 V, +/- 10%, X7R, 0402	0402
17	C39	1	100pF	CC0402KRX7R9BB101	Yageo America	CAP, CERM, 100 pF, 50 V, +/- 10%, X7R, 0402	0402
18	C40	1	2200pF	GRM155R61H222KA01D	MuRata	CAP, CERM, 2200 pF, 50 V, +/- 10%, X5R, 0402	0402
19	C50	1	91pF	GRM1555C1H910JA01D	MuRata	CAP, CERM, 91 pF, 50 V, +/- 5%, C0G/NP0, 0402	0402
20	C51	1	1800pF	GRM155R71H182KA01D	MuRata	CAP, CERM, 1800 pF, 50 V, +/- 10%, X7R, 0402	0402
21	C53	1	0.01uF	GRM033R61A103KA01D	MuRata	CAP, CERM, 0.01 µF, 10 V, +/- 10%, X5R, 0201	0201
22	D2, D3, D4, D5, D6, D7, D8, D9	8	White	LW QH8G-Q2S2-3K5L-1	OSRAM	LED, White, SMD	0402, White
23	J1	1		20-000016-01	Lintes Technology	Connector, Receptacle, USB Type C, R/A, SMT	Connector, Receptacle, USB Type C, SMT
24	J2, J3	2		PPPC102LFBN-RC	Sullins Connector Solutions	Receptacle, 100mil, 10x2, Gold, TH	10x2 Receptacle
25	J4	1		JPD1135-509-7F	Foxconn	Connector, DC Power Jack, R/A, 3 Pos, TH	Power connector
26	J6	1		90120-0122	Molex	Header, 100mil, 2x1, Tin, TH	Header 2x1
27	L1	1	21 ohm	FBMJ2125HM210NT	Taiyo Yuden	Ferrite Bead, 21 ohm @ 100MHz, 6A, 0805	0805
28	L2, L3, L4	3		ASPI-0630LR-100M-T15	ABRACON		7.2 mm x 6.65 mm
29	Q1, Q2	2	30V	CSD17309Q3	Texas Instruments	MOSFET, N-CH, 30 V, 60 A, SON 3.3x3.3mm	SON 3.3x3.3mm
30	Q3, Q4, Q5, Q6, Q7, Q8, Q9, Q10	8	50 V	DTC114EUAT106	Rohm	Transistor, NPN, 50 V, 0.05 A, SOT-323	SOT-323
31	R1	1	0.01	WSL0805R0100FEA18	Vishay-Dale	RES, 0.01 ohm, 1%, 0.25W, 0805	0805

Table 19. Bill of Materials (continued)

Item #	Designator	Quantity	Value	PartNumber	Manufacturer	Description	PackageReference
32	R3, R5, R10, R11, R22, R30, R38, R39, R40, R41, R46, R56, R60, R62, R65, R66, R69, R71	18	0	ERJ-1GE0R00C	Panasonic	RES, 0, 5%, 0.05 W, 0201	0201
33	R4, R7, R8, R9	4	3.3k	CRCW04023K30JNED	Vishay-Dale	RES, 3.3 k, 5%, 0.063 W, 0402	0402
34	R12, R13, R14, R15, R27, R42, R43, R44, R45	9	1.00k	CRCW02011K00FKED	Vishay-Dale	RES, 1.00 k, 1%, 0.05 W, 0201	0201
35	R20, R75, R76, R79, R80	5	3.83k	CRCW02013K83FKED	Vishay-Dale	RES, 3.83 k, 1%, 0.05 W, 0201	0201
36	R21, R24, R25, R26, R29, R33, R49, R52, R55, R70	10	100k	CRCW0201100KFKED	Vishay-Dale	RES, 100 k, 1%, 0.05 W, 0201	0201
37	R28	1	15.0k	CRCW040215K0FKED	Vishay-Dale	RES, 15.0 k, 1%, 0.063 W, 0402	0402
38	R72, R73, R74, R86, R87, R89, R90, R96	8	560	CRCW0402560RJNED	Vishay-Dale	RES, 560, 5%, 0.063 W, 0402	0402
39	R77, R78	2	9.09k	CRCW02019K09FKED	Vishay-Dale	RES, 9.09 k, 1%, 0.05 W, 0201	0201
40	R82, R92, R102	3	100k	CRCW0402100KFKED	Vishay-Dale	RES, 100 k, 1%, 0.063 W, 0402	0402
41	R84	1	32.4k	CRCW040232K4FKED	Vishay-Dale	RES, 32.4 k, 1%, 0.063 W, 0402	0402
42	R85	1	2.74k	CRCW04022K74FKED	Vishay-Dale	RES, 2.74 k, 1%, 0.063 W, 0402	0402
43	R88, R97, R109	3	47.5k	CRCW040247K5FKED	Vishay-Dale	RES, 47.5 k, 1%, 0.063 W, 0402	0402
44	R94	1	19.1k	CRCW040219K1FKED	Vishay-Dale	RES, 19.1 k, 1%, 0.063 W, 0402	0402
45	R95	1	8.45k	CRCW04028K45FKED	Vishay-Dale	RES, 8.45 k, 1%, 0.063 W, 0402	0402
46	R104	1	7.15k	CRCW04027K15FKED	Vishay-Dale	RES, 7.15 k, 1%, 0.063 W, 0402	0402
47	R108	1	9.53k	CRCW04029K53FKED	Vishay-Dale	RES, 9.53 k, 1%, 0.063 W, 0402	0402
48	S1	1		TDA04H0SB1	C&K Components	DIP Switch, SPST 4Pos, Slide, SMT	6.2x2.0x6.2mm
49	S3	1		B3U-1000P	Omron Electronic Components	SWITCH TACTILE SPST-NO 0.05A 12V	3x1.6x2.5mm
50	TP1, TP2, TP3, TP4, TP5	5		5019	Keystone	Test Point, Miniature, SMT	Test Point, Miniature, SMT
51	U1	1		W25Q80DVSNI	Winbond	3V, 8Mbit, Serial Flash Memory with Dual and Qual SPI, SOIC-8	SOIC-8
52	U2	1		TPS65982ABZQZR	Texas Instruments	TPS65982 Preview Specification, ZQZ0096A	ZQZ0096A
53	U3, U4	2		TPD4E05U06DQA	Texas Instruments	1, 4, 6 CHANNEL PROTECTION SOLUTION FOR SUPER-SPEED (UP TO 6 GBPS) INTERFACE, DQA0010A	DQA0010A
54	U5, U6, U7	3		TPS54335DRCR	Texas Instruments	4.5V to 28V Input, 3A Output, Synchronous SWIFT Step-Down DC-DC Converter, DRC0010J	DRC0010J
55	C27, C30, C38, C41, C49, C52	0	120pF	GRM1555C1H121JA01D	MuRata	CAP, CERM, 120 pF, 50 V, +/- 5%, C0G/NP0, 0402	0402
56	D1	0	40V	B340A-13-F	Diodes Inc.	Diode, Schottky, 40 V, 3 A, SMA	SMA
57	FID1, FID2, FID3, FID4, FID5, FID6	0		N/A	N/A	Fiducial mark. There is nothing to buy or mount.	Fiducial
58	H1, H2, H3, H4	0		NY PMS 440 0025 PH	B&F Fastener Supply	Machine Screw, Round, #4-40 x 1/4, Nylon, Philips panhead	Screw
59	H5, H6, H7, H8	0		1902C	Keystone	Standoff, Hex, 0.5"L #4-40 Nylon	Standoff
60	J5	0		PPPC031LFBN-RC	Sullins Connector Solutions	Receptacle, 100mil, 3x1, Gold, TH	Receptacle, 3x1, 2.54mm, TH
61	J7	0		15-91-2040	Molex	Header, 100mil, 2x2, Tin, SMT	2x2 100mil Tin Header

Table 19. Bill of Materials (continued)

Item #	Designator	Quantity	Value	PartNumber	Manufacturer	Description	PackageReference
62	J9	0		1040	Keystone	TEST POINT SLOTTED .118", TH	Test point, TH Slot Test point
63	R6, R16, R17, R18, R19, R23, R31, R32, R34, R35, R36, R37, R47, R48, R50, R51, R53, R54, R57, R58, R59, R61, R63, R64, R67, R68	0	0	ERJ-1GE0R00C	Panasonic	RES, 0, 5%, 0.05 W, 0201	0201
64	R81, R91, R101	0	220k	CRCW0402220KJNED	Vishay-Dale	RES, 220 k, 5%, 0.063 W, 0402	0402
65	R83, R93, R103	0	43.2k	CRCW040243K2FKED	Vishay-Dale	RES, 43.2 k, 1%, 0.063 W, 0402	0402
66	S2	0		TDA04H0SB1	C&K Components	DIP Switch, SPST 4Pos, Slide, SMT	6.2x2.0x6.2mm

9 Firmware Installation

The following procedure is intended to describe how to flash the WQ2580 IC of the TPS65982-EVM with firmware (1024kB .bin file) using an Aardvark SPI programmer by connecting to the SPI pins of header J2.

The following material needed to flash the TPS65982-EVM:

- TPS65982-EVM
- Aardvark SPI Programmer with accompanying USB cable
- Dell power adapter
- 1024kB .bin FW file, example “TPS65982-EVM_Flash-Image_RTM.bin”

9.1 Writing a Flash Image Using an Aardvark SPI Programmer

In the following seven steps there are images indicating additional information. Please use the legend in [Figure 13](#) to understand what image corresponds to what action.

Legend

- Action – Highlighted region must be clicked or activated 

- Warning – Highlighted region should NOT be clicked or activated 

○Wait - min, sec while computer executes action(s)

- ☺ Verify – Ensure that the result/output on user’s screen matches

Figure 13. Legend

9.2 Wire Aardvark to SPI Pins for Flash on the TPS65982-EVM board

Wire the Aardvark SPI pins to the corresponding SPI pins on the TPS65982-EVM J2 and J3 headers as shown in Figure 14.

NOTE: Once wire connections are made, connect the Dell Power Adapter (Barrel Jack AC Adapter) to the TPS65982-EVM to power up the board.

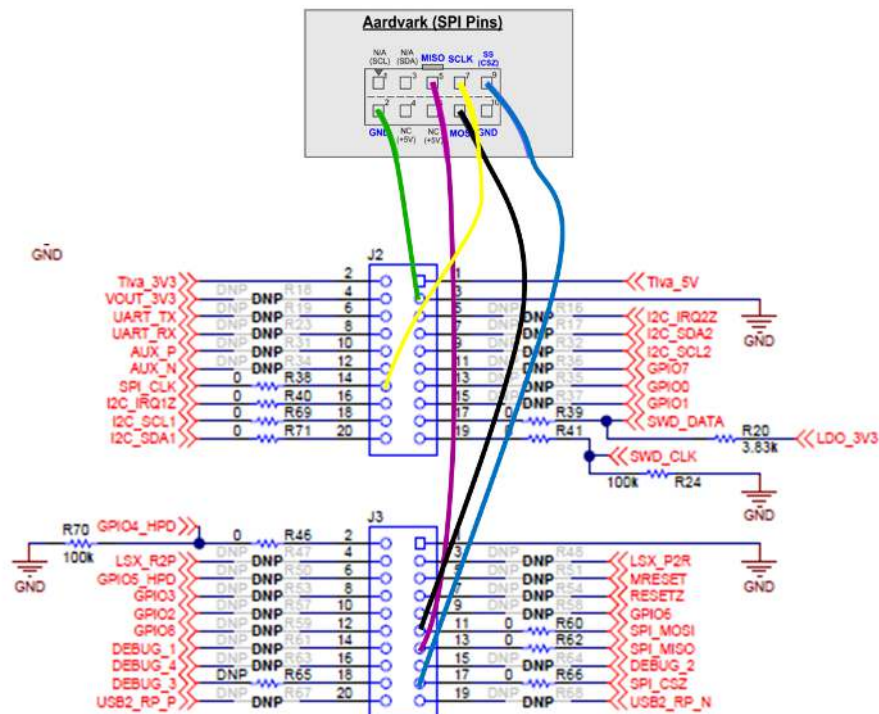

Figure 14. Aardvark Wired to SPI Pins

9.3 Run “Flash Center”.exe

Connect the Dell Power Adapter to the TPS65982-EVM and connect the Aardvark USB cable to your computer. Next, boot up the Flash Center software (Figure 15) from the directory location you previously installed it.

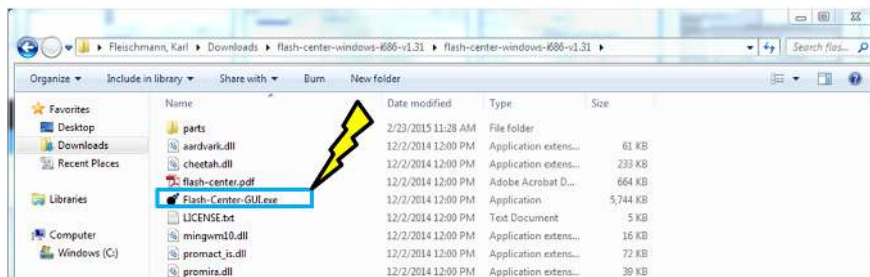

Figure 15. Flash Center GUI

9.4 Add Adapter

The Flash Center application uses a variety of adapters, in order to use the Aardvark adapter it must be added. To add, click “Add Adapters” (Figure 16) and select the Aardvark adapter when it appears as shown in Figure 17.

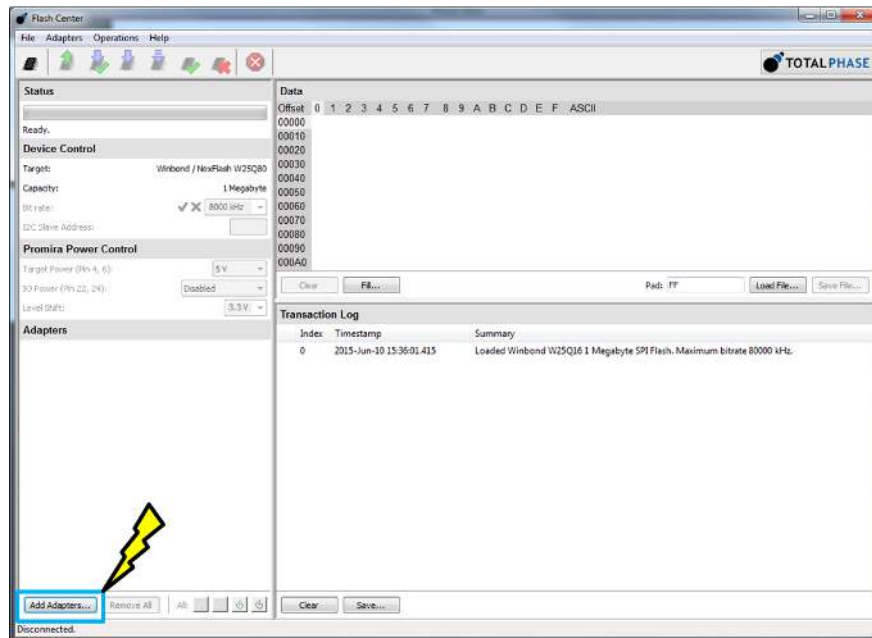

Figure 16. Add Adapters... Button

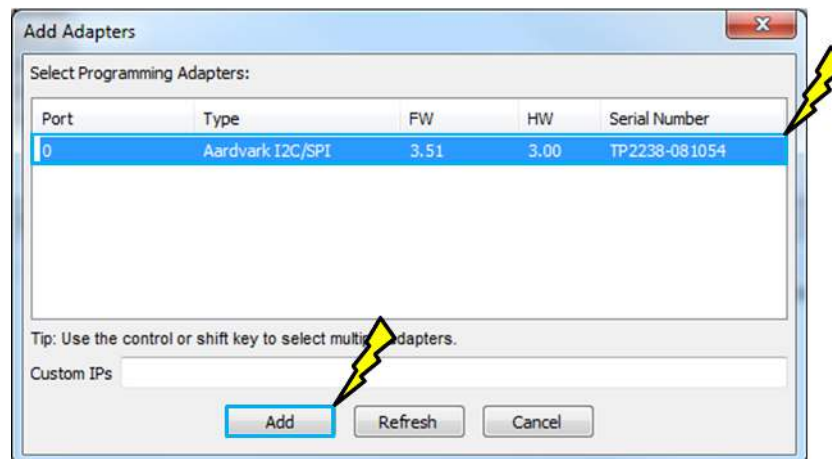

Figure 17. Add Adapters Selection

NOTE: It should automatically detect the Aardvark when adding the adapter; if however, it does not download the [Aardvark drivers](#) from Total Phase and follow the installation prompts.

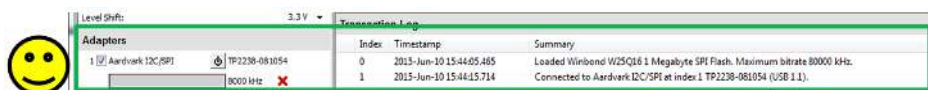

Figure 18. Adapter Detection

9.5 Choose Target (Device Type)

In order for the Flash Center to flash the TPS65982-EVM, the proper Flash or Device type must be selected. Click the “Choose Target” button to select the Target Device type in this case: SPI Flash → Winbond/NexFlash → W25Q80 as shown in Figure 19.

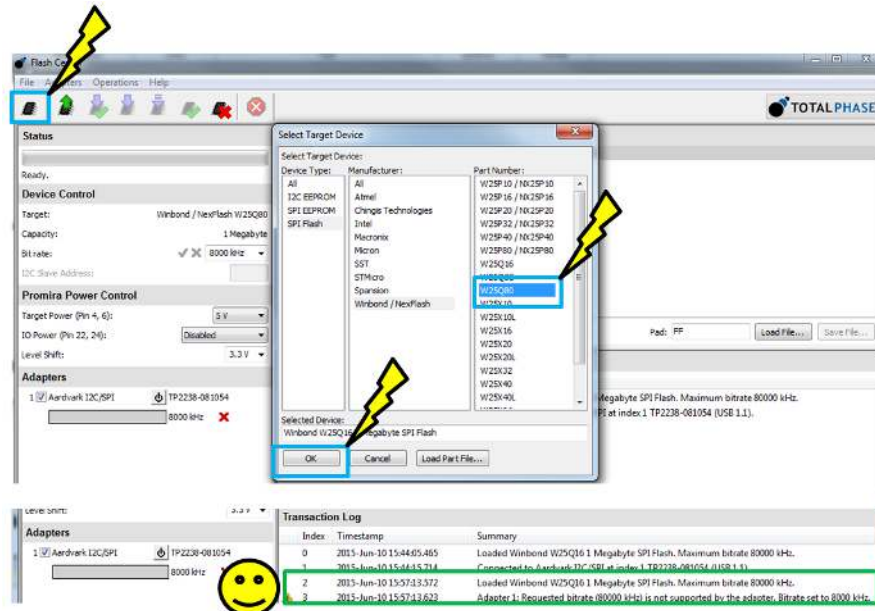

Figure 19. Select Target Device

9.6 Load Binary File

To load the binary file that will go onto the TPS65982-EVM, select load file and proceed to the directory where the binary file has been saved. After the binary file is selected, click 'Open'. If successful, the data section of the Flash Center should be full of values. See the screen shots in Figure 20 for examples.

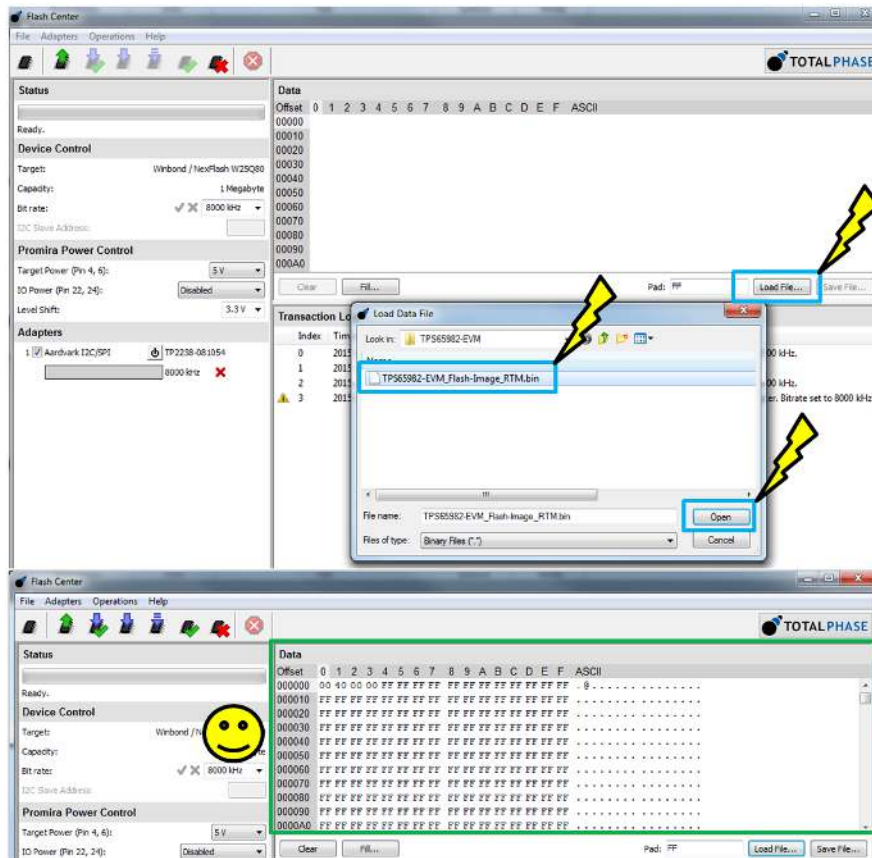

Figure 20. Loading Data Section of Flash Center

9.7 Program TPS65982-EVM

To program the TPS65982-EVM, select the Program button, wait approximately 2 minutes and the write should complete. To confirm that the TPS65982-EVM board has been programmed, either press S3 or unplug and re-plug the Dell Power Adapter. If it has been programmed then LED B (D5) will be on.

NOTE: If an error occurs, either the board is not being powered or the SPI pins are not connected properly.

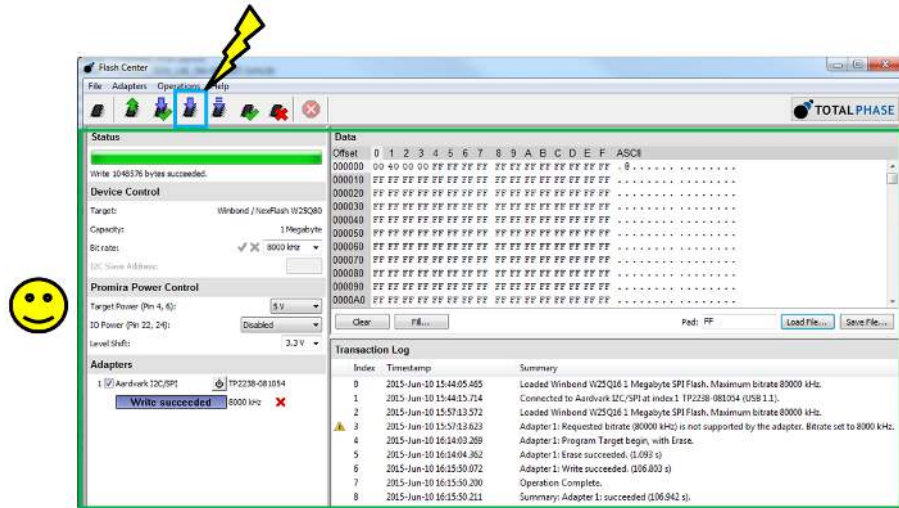

Figure 21. Programming the TPS65982-EVM

9.8 Verify (Optional)

To confirm if the loaded binary image matches the firmware installed on the TPS65982-EVM, click the verify button and see if it reports a success.

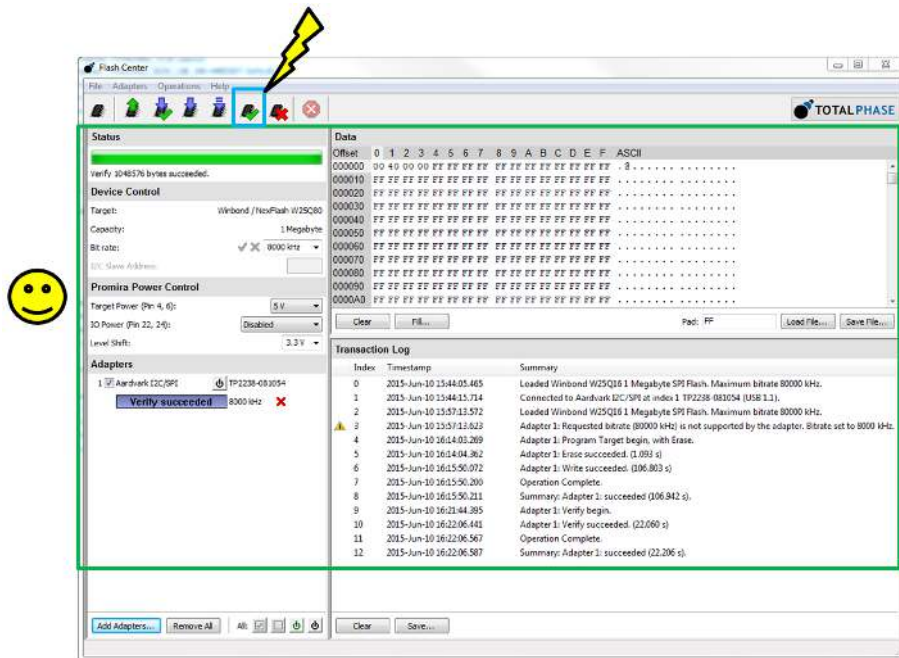

Figure 22. Verifying Binary Image

Revision History

Changes from B Revision (August 2015) to C Revision	Page
• Added <i>Using the TPS65986 on the TPS65982-EVM</i> section.	5
• Changed <i>TPS65982-EVM Configuration Table Overview</i> section, added many new subsections.	13

NOTE: Page numbers for previous revisions may differ from page numbers in the current version.

Revision History

Changes from A Revision (June 2015) to B Revision	Page
• Changed BOM to EVM Rev. D.	35

NOTE: Page numbers for previous revisions may differ from page numbers in the current version.

Revision History

Changes from Original (June 2015) to A Revision	Page
• Changed format to standard EVM UG template.	1
• Added <i>Firmware Installation</i> section.	38

NOTE: Page numbers for previous revisions may differ from page numbers in the current version.

STANDARD TERMS AND CONDITIONS FOR EVALUATION MODULES

1. *Delivery:* TI delivers TI evaluation boards, kits, or modules, including any accompanying demonstration software, components, or documentation (collectively, an "EVM" or "EVMs") to the User ("User") in accordance with the terms and conditions set forth herein. Acceptance of the EVM is expressly subject to the following terms and conditions.
 - 1.1 EVMs are intended solely for product or software developers for use in a research and development setting to facilitate feasibility evaluation, experimentation, or scientific analysis of TI semiconductors products. EVMs have no direct function and are not finished products. EVMs shall not be directly or indirectly assembled as a part or subassembly in any finished product. For clarification, any software or software tools provided with the EVM ("Software") shall not be subject to the terms and conditions set forth herein but rather shall be subject to the applicable terms and conditions that accompany such Software
 - 1.2 EVMs are not intended for consumer or household use. EVMs may not be sold, sublicensed, leased, rented, loaned, assigned, or otherwise distributed for commercial purposes by Users, in whole or in part, or used in any finished product or production system.
2. *Limited Warranty and Related Remedies/Disclaimers:*
 - 2.1 These terms and conditions do not apply to Software. The warranty, if any, for Software is covered in the applicable Software License Agreement.
 - 2.2 TI warrants that the TI EVM will conform to TI's published specifications for ninety (90) days after the date TI delivers such EVM to User. Notwithstanding the foregoing, TI shall not be liable for any defects that are caused by neglect, misuse or mistreatment by an entity other than TI, including improper installation or testing, or for any EVMs that have been altered or modified in any way by an entity other than TI. Moreover, TI shall not be liable for any defects that result from User's design, specifications or instructions for such EVMs. Testing and other quality control techniques are used to the extent TI deems necessary or as mandated by government requirements. TI does not test all parameters of each EVM.
 - 2.3 If any EVM fails to conform to the warranty set forth above, TI's sole liability shall be at its option to repair or replace such EVM, or credit User's account for such EVM. TI's liability under this warranty shall be limited to EVMs that are returned during the warranty period to the address designated by TI and that are determined by TI not to conform to such warranty. If TI elects to repair or replace such EVM, TI shall have a reasonable time to repair such EVM or provide replacements. Repaired EVMs shall be warranted for the remainder of the original warranty period. Replaced EVMs shall be warranted for a new full ninety (90) day warranty period.
3. *Regulatory Notices:*
 - 3.1 *United States*
 - 3.1.1 *Notice applicable to EVMs not FCC-Approved:*

This kit is designed to allow product developers to evaluate electronic components, circuitry, or software associated with the kit to determine whether to incorporate such items in a finished product and software developers to write software applications for use with the end product. This kit is not a finished product and when assembled may not be resold or otherwise marketed unless all required FCC equipment authorizations are first obtained. Operation is subject to the condition that this product not cause harmful interference to licensed radio stations and that this product accept harmful interference. Unless the assembled kit is designed to operate under part 15, part 18 or part 95 of this chapter, the operator of the kit must operate under the authority of an FCC license holder or must secure an experimental authorization under part 5 of this chapter.
 - 3.1.2 *For EVMs annotated as FCC – FEDERAL COMMUNICATIONS COMMISSION Part 15 Compliant:*

CAUTION

This device complies with part 15 of the FCC Rules. Operation is subject to the following two conditions: (1) This device may not cause harmful interference, and (2) this device must accept any interference received, including interference that may cause undesired operation.

Changes or modifications not expressly approved by the party responsible for compliance could void the user's authority to operate the equipment.

FCC Interference Statement for Class A EVM devices

NOTE: This equipment has been tested and found to comply with the limits for a Class A digital device, pursuant to part 15 of the FCC Rules. These limits are designed to provide reasonable protection against harmful interference when the equipment is operated in a commercial environment. This equipment generates, uses, and can radiate radio frequency energy and, if not installed and used in accordance with the instruction manual, may cause harmful interference to radio communications. Operation of this equipment in a residential area is likely to cause harmful interference in which case the user will be required to correct the interference at his own expense.

FCC Interference Statement for Class B EVM devices

NOTE: This equipment has been tested and found to comply with the limits for a Class B digital device, pursuant to part 15 of the FCC Rules. These limits are designed to provide reasonable protection against harmful interference in a residential installation. This equipment generates, uses and can radiate radio frequency energy and, if not installed and used in accordance with the instructions, may cause harmful interference to radio communications. However, there is no guarantee that interference will not occur in a particular installation. If this equipment does cause harmful interference to radio or television reception, which can be determined by turning the equipment off and on, the user is encouraged to try to correct the interference by one or more of the following measures:

- Reorient or relocate the receiving antenna.
- Increase the separation between the equipment and receiver.
- Connect the equipment into an outlet on a circuit different from that to which the receiver is connected.
- Consult the dealer or an experienced radio/TV technician for help.

3.2 Canada

3.2.1 For EVMs issued with an Industry Canada Certificate of Conformance to RSS-210

Concerning EVMs Including Radio Transmitters:

This device complies with Industry Canada license-exempt RSS standard(s). Operation is subject to the following two conditions: (1) this device may not cause interference, and (2) this device must accept any interference, including interference that may cause undesired operation of the device.

Concernant les EVMs avec appareils radio:

Le présent appareil est conforme aux CNR d'Industrie Canada applicables aux appareils radio exempts de licence. L'exploitation est autorisée aux deux conditions suivantes: (1) l'appareil ne doit pas produire de brouillage, et (2) l'utilisateur de l'appareil doit accepter tout brouillage radioélectrique subi, même si le brouillage est susceptible d'en compromettre le fonctionnement.

Concerning EVMs Including Detachable Antennas:

Under Industry Canada regulations, this radio transmitter may only operate using an antenna of a type and maximum (or lesser) gain approved for the transmitter by Industry Canada. To reduce potential radio interference to other users, the antenna type and its gain should be so chosen that the equivalent isotropically radiated power (e.i.r.p.) is not more than that necessary for successful communication. This radio transmitter has been approved by Industry Canada to operate with the antenna types listed in the user guide with the maximum permissible gain and required antenna impedance for each antenna type indicated. Antenna types not included in this list, having a gain greater than the maximum gain indicated for that type, are strictly prohibited for use with this device.

Concernant les EVMs avec antennes détachables

Conformément à la réglementation d'Industrie Canada, le présent émetteur radio peut fonctionner avec une antenne d'un type et d'un gain maximal (ou inférieur) approuvé pour l'émetteur par Industrie Canada. Dans le but de réduire les risques de brouillage radioélectrique à l'intention des autres utilisateurs, il faut choisir le type d'antenne et son gain de sorte que la puissance isotrope rayonnée équivalente (p.i.r.e.) ne dépasse pas l'intensité nécessaire à l'établissement d'une communication satisfaisante. Le présent émetteur radio a été approuvé par Industrie Canada pour fonctionner avec les types d'antenne énumérés dans le manuel d'usage et ayant un gain admissible maximal et l'impédance requise pour chaque type d'antenne. Les types d'antenne non inclus dans cette liste, ou dont le gain est supérieur au gain maximal indiqué, sont strictement interdits pour l'exploitation de l'émetteur.

3.3 Japan

3.3.1 *Notice for EVMs delivered in Japan:* Please see http://www.tij.co.jp/lstds/ti_ja/general/eStore/notice_01.page 日本国内に輸入される評価用キット、ボードについては、次のところをご覧ください。
http://www.tij.co.jp/lstds/ti_ja/general/eStore/notice_01.page

3.3.2 *Notice for Users of EVMs Considered "Radio Frequency Products" in Japan:* EVMs entering Japan may not be certified by TI as conforming to Technical Regulations of Radio Law of Japan.

If User uses EVMs in Japan, not certified to Technical Regulations of Radio Law of Japan, User is required by Radio Law of Japan to follow the instructions below with respect to EVMs:

1. Use EVMs in a shielded room or any other test facility as defined in the notification #173 issued by Ministry of Internal Affairs and Communications on March 28, 2006, based on Sub-section 1.1 of Article 6 of the Ministry's Rule for Enforcement of Radio Law of Japan,
2. Use EVMs only after User obtains the license of Test Radio Station as provided in Radio Law of Japan with respect to EVMs, or
3. Use of EVMs only after User obtains the Technical Regulations Conformity Certification as provided in Radio Law of Japan with respect to EVMs. Also, do not transfer EVMs, unless User gives the same notice above to the transferee. Please note that if User does not follow the instructions above, User will be subject to penalties of Radio Law of Japan.

【無線電波を送信する製品の開発キットをお使いになる際の注意事項】 開発キットの中には技術基準適合証明を受けていないものがあります。技術適合証明を受けていないものご使用に際しては、電波法遵守のため、以下のいずれかの措置を取っていただく必要がありますのでご注意ください。

1. 電波法施行規則第6条第1項第1号に基づく平成18年3月28日総務省告示第173号で定められた電波暗室等の試験設備でご使用いただく。
2. 実験局の免許を取得後ご使用いただく。
3. 技術基準適合証明を取得後ご使用いただく。

なお、本製品は、上記の「ご使用にあたっての注意」を譲渡先、移転先に通知しない限り、譲渡、移転できないものとします。

上記を遵守頂けない場合は、電波法の罰則が適用される可能性があることをご留意ください。日本テキサス・インスツルメンツ株式会社

東京都新宿区西新宿 6 丁目 2 4 番 1 号

西新宿三井ビル

3.3.3 *Notice for EVMs for Power Line Communication:* Please see http://www.tij.co.jp/llds/ti_ja/general/eStore/notice_02.page

電力線搬送波通信についての開発キットをお使いになる際の注意事項については、次のところをご覧ください。http://www.tij.co.jp/llds/ti_ja/general/eStore/notice_02.page

4 *EVM Use Restrictions and Warnings:*

4.1 EVMS ARE NOT FOR USE IN FUNCTIONAL SAFETY AND/OR SAFETY CRITICAL EVALUATIONS, INCLUDING BUT NOT LIMITED TO EVALUATIONS OF LIFE SUPPORT APPLICATIONS.

4.2 User must read and apply the user guide and other available documentation provided by TI regarding the EVM prior to handling or using the EVM, including without limitation any warning or restriction notices. The notices contain important safety information related to, for example, temperatures and voltages.

4.3 *Safety-Related Warnings and Restrictions:*

4.3.1 User shall operate the EVM within TI's recommended specifications and environmental considerations stated in the user guide, other available documentation provided by TI, and any other applicable requirements and employ reasonable and customary safeguards. Exceeding the specified performance ratings and specifications (including but not limited to input and output voltage, current, power, and environmental ranges) for the EVM may cause personal injury or death, or property damage. If there are questions concerning performance ratings and specifications, User should contact a TI field representative prior to connecting interface electronics including input power and intended loads. Any loads applied outside of the specified output range may also result in unintended and/or inaccurate operation and/or possible permanent damage to the EVM and/or interface electronics. Please consult the EVM user guide prior to connecting any load to the EVM output. If there is uncertainty as to the load specification, please contact a TI field representative. During normal operation, even with the inputs and outputs kept within the specified allowable ranges, some circuit components may have elevated case temperatures. These components include but are not limited to linear regulators, switching transistors, pass transistors, current sense resistors, and heat sinks, which can be identified using the information in the associated documentation. When working with the EVM, please be aware that the EVM may become very warm.

4.3.2 EVMs are intended solely for use by technically qualified, professional electronics experts who are familiar with the dangers and application risks associated with handling electrical mechanical components, systems, and subsystems. User assumes all responsibility and liability for proper and safe handling and use of the EVM by User or its employees, affiliates, contractors or designees. User assumes all responsibility and liability to ensure that any interfaces (electronic and/or mechanical) between the EVM and any human body are designed with suitable isolation and means to safely limit accessible leakage currents to minimize the risk of electrical shock hazard. User assumes all responsibility and liability for any improper or unsafe handling or use of the EVM by User or its employees, affiliates, contractors or designees.

4.4 User assumes all responsibility and liability to determine whether the EVM is subject to any applicable international, federal, state, or local laws and regulations related to User's handling and use of the EVM and, if applicable, User assumes all responsibility and liability for compliance in all respects with such laws and regulations. User assumes all responsibility and liability for proper disposal and recycling of the EVM consistent with all applicable international, federal, state, and local requirements.

5. *Accuracy of Information:* To the extent TI provides information on the availability and function of EVMs, TI attempts to be as accurate as possible. However, TI does not warrant the accuracy of EVM descriptions, EVM availability or other information on its websites as accurate, complete, reliable, current, or error-free.

6. *Disclaimers:*
- 6.1 EXCEPT AS SET FORTH ABOVE, EVMS AND ANY WRITTEN DESIGN MATERIALS PROVIDED WITH THE EVM (AND THE DESIGN OF THE EVM ITSELF) ARE PROVIDED "AS IS" AND "WITH ALL FAULTS." TI DISCLAIMS ALL OTHER WARRANTIES, EXPRESS OR IMPLIED, REGARDING SUCH ITEMS, INCLUDING BUT NOT LIMITED TO ANY IMPLIED WARRANTIES OF MERCHANTABILITY OR FITNESS FOR A PARTICULAR PURPOSE OR NON-INFRINGEMENT OF ANY THIRD PARTY PATENTS, COPYRIGHTS, TRADE SECRETS OR OTHER INTELLECTUAL PROPERTY RIGHTS.
- 6.2 EXCEPT FOR THE LIMITED RIGHT TO USE THE EVM SET FORTH HEREIN, NOTHING IN THESE TERMS AND CONDITIONS SHALL BE CONSTRUED AS GRANTING OR CONFERRING ANY RIGHTS BY LICENSE, PATENT, OR ANY OTHER INDUSTRIAL OR INTELLECTUAL PROPERTY RIGHT OF TI, ITS SUPPLIERS/LICENSORS OR ANY OTHER THIRD PARTY, TO USE THE EVM IN ANY FINISHED END-USER OR READY-TO-USE FINAL PRODUCT, OR FOR ANY INVENTION, DISCOVERY OR IMPROVEMENT MADE, CONCEIVED OR ACQUIRED PRIOR TO OR AFTER DELIVERY OF THE EVM.
7. *USER'S INDEMNITY OBLIGATIONS AND REPRESENTATIONS.* USER WILL DEFEND, INDEMNIFY AND HOLD TI, ITS LICENSORS AND THEIR REPRESENTATIVES HARMLESS FROM AND AGAINST ANY AND ALL CLAIMS, DAMAGES, LOSSES, EXPENSES, COSTS AND LIABILITIES (COLLECTIVELY, "CLAIMS") ARISING OUT OF OR IN CONNECTION WITH ANY HANDLING OR USE OF THE EVM THAT IS NOT IN ACCORDANCE WITH THESE TERMS AND CONDITIONS. THIS OBLIGATION SHALL APPLY WHETHER CLAIMS ARISE UNDER STATUTE, REGULATION, OR THE LAW OF TORT, CONTRACT OR ANY OTHER LEGAL THEORY, AND EVEN IF THE EVM FAILS TO PERFORM AS DESCRIBED OR EXPECTED.
8. *Limitations on Damages and Liability:*
- 8.1 *General Limitations.* IN NO EVENT SHALL TI BE LIABLE FOR ANY SPECIAL, COLLATERAL, INDIRECT, PUNITIVE, INCIDENTAL, CONSEQUENTIAL, OR EXEMPLARY DAMAGES IN CONNECTION WITH OR ARISING OUT OF THESE TERMS AND CONDITIONS OR THE USE OF THE EVMS PROVIDED HEREUNDER, REGARDLESS OF WHETHER TI HAS BEEN ADVISED OF THE POSSIBILITY OF SUCH DAMAGES. EXCLUDED DAMAGES INCLUDE, BUT ARE NOT LIMITED TO, COST OF REMOVAL OR REINSTALLATION, ANCILLARY COSTS TO THE PROCUREMENT OF SUBSTITUTE GOODS OR SERVICES, RETESTING, OUTSIDE COMPUTER TIME, LABOR COSTS, LOSS OF GOODWILL, LOSS OF PROFITS, LOSS OF SAVINGS, LOSS OF USE, LOSS OF DATA, OR BUSINESS INTERRUPTION. NO CLAIM, SUIT OR ACTION SHALL BE BROUGHT AGAINST TI MORE THAN ONE YEAR AFTER THE RELATED CAUSE OF ACTION HAS OCCURRED.
- 8.2 *Specific Limitations.* IN NO EVENT SHALL TI'S AGGREGATE LIABILITY FROM ANY WARRANTY OR OTHER OBLIGATION ARISING OUT OF OR IN CONNECTION WITH THESE TERMS AND CONDITIONS, OR ANY USE OF ANY TI EVM PROVIDED HEREUNDER, EXCEED THE TOTAL AMOUNT PAID TO TI FOR THE PARTICULAR UNITS SOLD UNDER THESE TERMS AND CONDITIONS WITH RESPECT TO WHICH LOSSES OR DAMAGES ARE CLAIMED. THE EXISTENCE OF MORE THAN ONE CLAIM AGAINST THE PARTICULAR UNITS SOLD TO USER UNDER THESE TERMS AND CONDITIONS SHALL NOT ENLARGE OR EXTEND THIS LIMIT.
9. *Return Policy.* Except as otherwise provided, TI does not offer any refunds, returns, or exchanges. Furthermore, no return of EVM(s) will be accepted if the package has been opened and no return of the EVM(s) will be accepted if they are damaged or otherwise not in a resalable condition. If User feels it has been incorrectly charged for the EVM(s) it ordered or that delivery violates the applicable order, User should contact TI. All refunds will be made in full within thirty (30) working days from the return of the components(s), excluding any postage or packaging costs.
10. *Governing Law:* These terms and conditions shall be governed by and interpreted in accordance with the laws of the State of Texas, without reference to conflict-of-laws principles. User agrees that non-exclusive jurisdiction for any dispute arising out of or relating to these terms and conditions lies within courts located in the State of Texas and consents to venue in Dallas County, Texas. Notwithstanding the foregoing, any judgment may be enforced in any United States or foreign court, and TI may seek injunctive relief in any United States or foreign court.

Mailing Address: Texas Instruments, Post Office Box 655303, Dallas, Texas 75265
Copyright © 2015, Texas Instruments Incorporated

IMPORTANT NOTICE

Texas Instruments Incorporated and its subsidiaries (TI) reserve the right to make corrections, enhancements, improvements and other changes to its semiconductor products and services per JESD46, latest issue, and to discontinue any product or service per JESD48, latest issue. Buyers should obtain the latest relevant information before placing orders and should verify that such information is current and complete. All semiconductor products (also referred to herein as "components") are sold subject to TI's terms and conditions of sale supplied at the time of order acknowledgment.

TI warrants performance of its components to the specifications applicable at the time of sale, in accordance with the warranty in TI's terms and conditions of sale of semiconductor products. Testing and other quality control techniques are used to the extent TI deems necessary to support this warranty. Except where mandated by applicable law, testing of all parameters of each component is not necessarily performed.

TI assumes no liability for applications assistance or the design of Buyers' products. Buyers are responsible for their products and applications using TI components. To minimize the risks associated with Buyers' products and applications, Buyers should provide adequate design and operating safeguards.

TI does not warrant or represent that any license, either express or implied, is granted under any patent right, copyright, mask work right, or other intellectual property right relating to any combination, machine, or process in which TI components or services are used. Information published by TI regarding third-party products or services does not constitute a license to use such products or services or a warranty or endorsement thereof. Use of such information may require a license from a third party under the patents or other intellectual property of the third party, or a license from TI under the patents or other intellectual property of TI.

Reproduction of significant portions of TI information in TI data books or data sheets is permissible only if reproduction is without alteration and is accompanied by all associated warranties, conditions, limitations, and notices. TI is not responsible or liable for such altered documentation. Information of third parties may be subject to additional restrictions.

Resale of TI components or services with statements different from or beyond the parameters stated by TI for that component or service voids all express and any implied warranties for the associated TI component or service and is an unfair and deceptive business practice. TI is not responsible or liable for any such statements.

Buyer acknowledges and agrees that it is solely responsible for compliance with all legal, regulatory and safety-related requirements concerning its products, and any use of TI components in its applications, notwithstanding any applications-related information or support that may be provided by TI. Buyer represents and agrees that it has all the necessary expertise to create and implement safeguards which anticipate dangerous consequences of failures, monitor failures and their consequences, lessen the likelihood of failures that might cause harm and take appropriate remedial actions. Buyer will fully indemnify TI and its representatives against any damages arising out of the use of any TI components in safety-critical applications.

In some cases, TI components may be promoted specifically to facilitate safety-related applications. With such components, TI's goal is to help enable customers to design and create their own end-product solutions that meet applicable functional safety standards and requirements. Nonetheless, such components are subject to these terms.

No TI components are authorized for use in FDA Class III (or similar life-critical medical equipment) unless authorized officers of the parties have executed a special agreement specifically governing such use.

Only those TI components which TI has specifically designated as military grade or "enhanced plastic" are designed and intended for use in military/aerospace applications or environments. Buyer acknowledges and agrees that any military or aerospace use of TI components which have **not** been so designated is solely at the Buyer's risk, and that Buyer is solely responsible for compliance with all legal and regulatory requirements in connection with such use.

TI has specifically designated certain components as meeting ISO/TS16949 requirements, mainly for automotive use. In any case of use of non-designated products, TI will not be responsible for any failure to meet ISO/TS16949.

Products

Audio	www.ti.com/audio
Amplifiers	amplifier.ti.com
Data Converters	dataconverter.ti.com
DLP® Products	www.dlp.com
DSP	dsp.ti.com
Clocks and Timers	www.ti.com/clocks
Interface	interface.ti.com
Logic	logic.ti.com
Power Mgmt	power.ti.com
Microcontrollers	microcontroller.ti.com
RFID	www.ti-rfid.com
OMAP Applications Processors	www.ti.com/omap
Wireless Connectivity	www.ti.com/wirelessconnectivity

Applications

Automotive and Transportation	www.ti.com/automotive
Communications and Telecom	www.ti.com/communications
Computers and Peripherals	www.ti.com/computers
Consumer Electronics	www.ti.com/consumer-apps
Energy and Lighting	www.ti.com/energy
Industrial	www.ti.com/industrial
Medical	www.ti.com/medical
Security	www.ti.com/security
Space, Avionics and Defense	www.ti.com/space-avionics-defense
Video and Imaging	www.ti.com/video

TI E2E Community

e2e.ti.com