



SOLID STATE INC.

46 FARRAND STREET
BLOOMFIELD, NEW JERSEY 07003

COMPLEMENTARY SILICON PLASTIC POWER TRANSISTORS

... designed for use in general purpose power amplifier and switching applications.

FEATURES:

- * Collector-Emitter Sustaining Voltage - $V_{CEO(max)}$ = 40V(Min)- TIP29,TIP30
60V(Min)- TIP29A,TIP30A
80V(Min)- TIP29B,TIP30B
100V(Min)-TIP29C,TIP30C
- * Collector-Emitter Saturation Voltage- $V_{CE(sat)}$ = 0.7V(Max)@ $I_C = 1.0$ A
- * Current Gain-Bandwidth Product $f_T = 3.0$ MHz (Min)@ $I_C = 200$ mA

MAXIMUM RATINGS

Characteristic	Symbol	TIP29 TIP30	TIP29A TIP30A	TIP29B TIP30B	TIP29C TIP30C	Unit
Collector-Emitter Voltage	V_{CEO}	40	60	80	100	V
Collector-Base Voltage	V_{CBO}	40	60	80	100	V
Emitter-Base Voltage	V_{EBO}	5.0				V
Collector Current - Continuous - Peak	I_C	1.0 3.0				A
Base Current	I_B	0.4				A
Total Power Dissipation@ $T_C = 25^\circ C$ Derate above $25^\circ C$	P_D	30 0.24				W W/ $^\circ C$
Operating and Storage Junction Temperature Range	T_J, T_{STG}	-65 to +150				$^\circ C$

THERMAL CHARACTERISTICS

Characteristic	Symbol	Max	Unit
Thermal Resistance Junction to Case	$R_{\theta jc}$	4.167	$^\circ C/W$

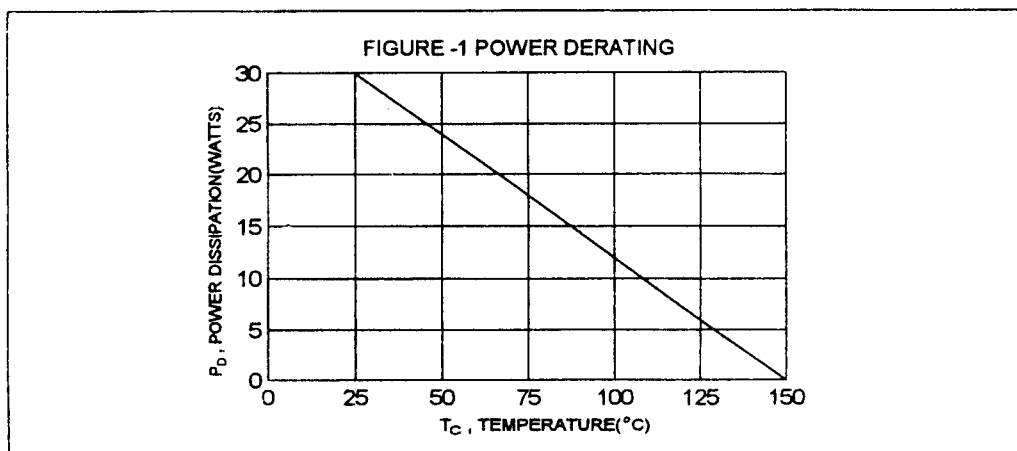

NPN	PNP
TIP29	TIP30
TIP29A	TIP30A
TIP29B	TIP30B
TIP29C	TIP30C

1.0 AMPERE
COMPLEMENTARY SILICON
POWER TRANSISTORS
40-100 VOLTS
30 WATTS

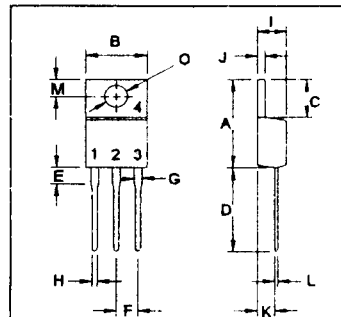
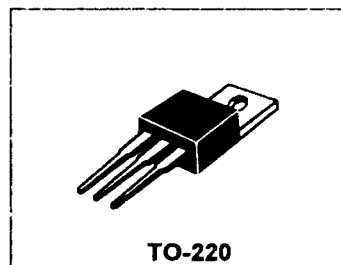

PIN 1.BASE
2.COLLECTOR
3.EMITTER
4.COLLECTOR(CASE)

DIM	MILLIMETERS	
	MIN	MAX
A	14.68	15.31
B	9.78	10.42
C	5.01	6.52
D	13.06	14.62
E	3.57	4.07
F	2.42	3.66
G	1.12	1.36
H	0.72	0.96
I	4.22	4.98
J	1.14	1.38
K	2.20	2.97
L	0.33	0.55
M	2.48	2.98
O	3.70	3.90

TIP29, TIP29A, TIP29B, TIP29C NPN / TIP30, TIP30A, TIP30B, TIP30C PNP

ELECTRICAL CHARACTERISTICS ($T_c = 25^\circ\text{C}$ unless otherwise noted)

Characteristic	Symbol	Min	Max	Unit
----------------	--------	-----	-----	------

OFF CHARACTERISTICS

Collector-Emitter Sustaining Voltage(1) ($I_C = 30\text{ mA}$, $I_B = 0$)	TIP29, TIP30 TIP29A, TIP30A TIP29B, TIP30B TIP29C, TIP30C	$V_{CEO(sus)}$	40 60 80 100	V
Collector Cutoff Current ($V_{CE} = 30\text{ V}$, $I_B = 0$) ($V_{CE} = 60\text{ V}$, $I_B = 0$)	TIP29, TIP30, TIP29A, TIP30A ←TIP29B, TIP30B, TIP29C, TIP30C	I_{CEO}	0.3 0.3	mA
Collector Cutoff Current ($V_{CE} = 40\text{ V}$, $V_{EB} = 0$) ($V_{CE} = 60\text{ V}$, $V_{EB} = 0$) ($V_{CE} = 80\text{ V}$, $V_{EB} = 0$) ($V_{CE} = 100\text{ V}$, $V_{EB} = 0$)	TIP29, TIP30 TIP29A, TIP30A TIP29B, TIP30B TIP29C, TIP30C	I_{CES}	0.2 0.2 0.2 0.2	mA
Emitter Cutoff Current ($V_{EB} = 5.0\text{ V}$, $I_C = 0$)		I_{EBO}	1.0	mA

ON CHARACTERISTICS (1)

DC Current Gain ($I_C = 0.2\text{ A}$, $V_{CE} = 4.0\text{ V}$) ($I_C = 1.0\text{ A}$, $V_{CE} = 4.0\text{ V}$)	h_{FE}	40 15	75	
Collector-Emitter Saturation Voltage ($I_C = 1.0\text{ A}$, $I_B = 125\text{ mA}$)	$V_{CE(sat)}$		0.7	V
Base-Emitter On Voltage ($I_C = 1.0\text{ A}$, $V_{CE} = 4.0\text{ V}$)	$V_{BE(on)}$		1.3	V

DYNAMIC CHARACTERISTICS

Current Gain - Bandwidth Product (2) ($I_C = 200\text{ mA}$, $V_{CE} = 10\text{ V}$, $f = 1\text{ MHz}$)	f_T	3.0		MHz
Small Signal Current Gain ($I_C = 200\text{ mA}$, $V_{CE} = 10\text{ V}$, $f = 1\text{ kHz}$)	h_{fe}	20		

(1) Pulse Test: Pulse width $\leq 300\ \mu\text{s}$, Duty Cycle $\leq 2.0\%$

(2) $f_T = |h_{fe}| \cdot f_{TEST}$

FIG-2 TURN-ON TIME

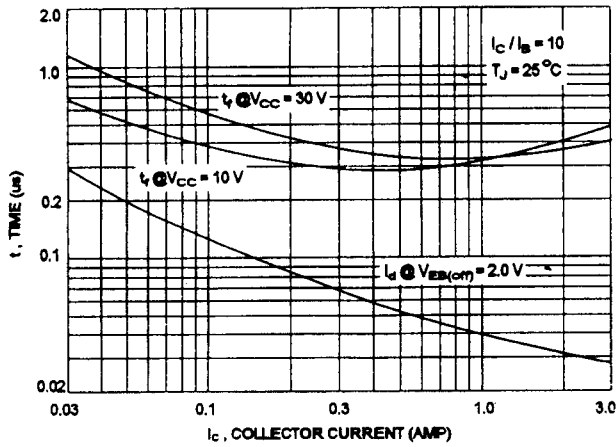

FIGURE 3 - SWITCHING TIME EQUIVALENT CIRCUIT

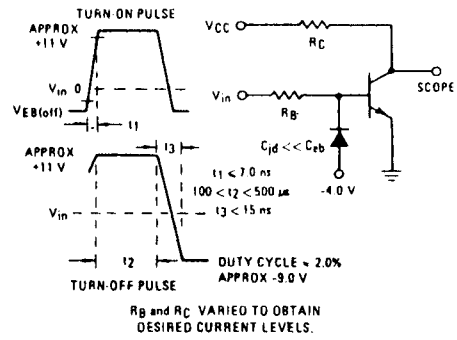

FIG-4 DC CURRENT GAIN

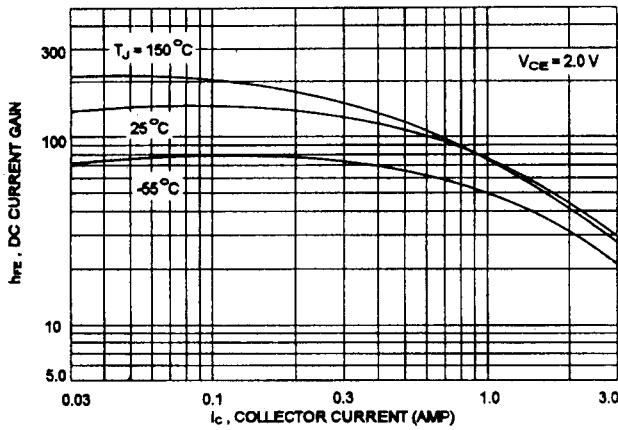

FIG-5 TURN-OFF TIME

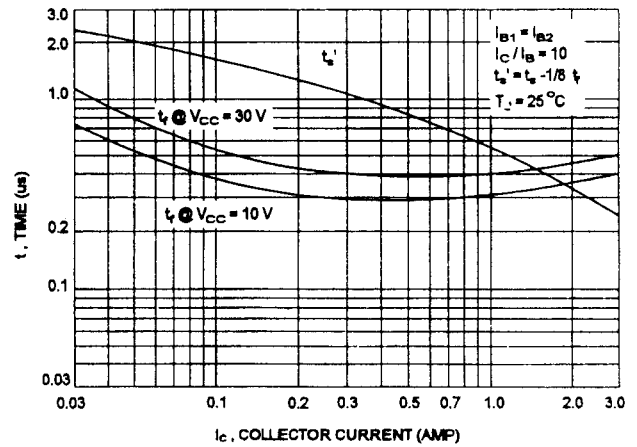
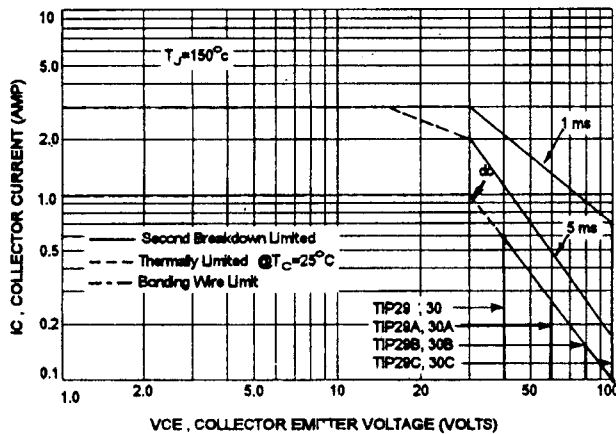

FIG-6 ACTIVE REGION SAFE OPERATING AREA



There are two limitation on the power handling ability of a transistor: average junction temperature and second breakdown safe operating area curves indicate I_C - V_{CE} limits of the transistor that must be observed for reliable operation i.e., the transistor must not be subjected to greater dissipation than curves indicate.

The data of FIG-6 curve is base on $T_{J(PK)} = 150^\circ\text{C}$; T_C is variable depending on power level. second breakdown pulse limits are valid for duty cycles to 10% provided $T_{J(PK)} \leq 150^\circ\text{C}$. At high case temperatures, thermal limitation will reduce the power that can be handled to values less than the limitations imposed by second breakdown.