

## **AN-1631 LP55281 Evaluation Kit**

### **1 General Description**

The LP55281 is a quad RGB LED driver for handheld devices. It can drive 4 RGB LED sets and a single fun light LED. The boost DC-DC converter drives high current loads with high efficiency. The RGB driver can drive individual color LEDs or RGB LEDs powered from boost output or external supply. Built-in audio synchronization feature allows easy control of LP55281. Small DSBGA package or DSBGAxt package together with minimum number of external components is a best fit for handheld devices. LP55281 has also a LED test feature, which can be used for example in production for checking the LED connections.

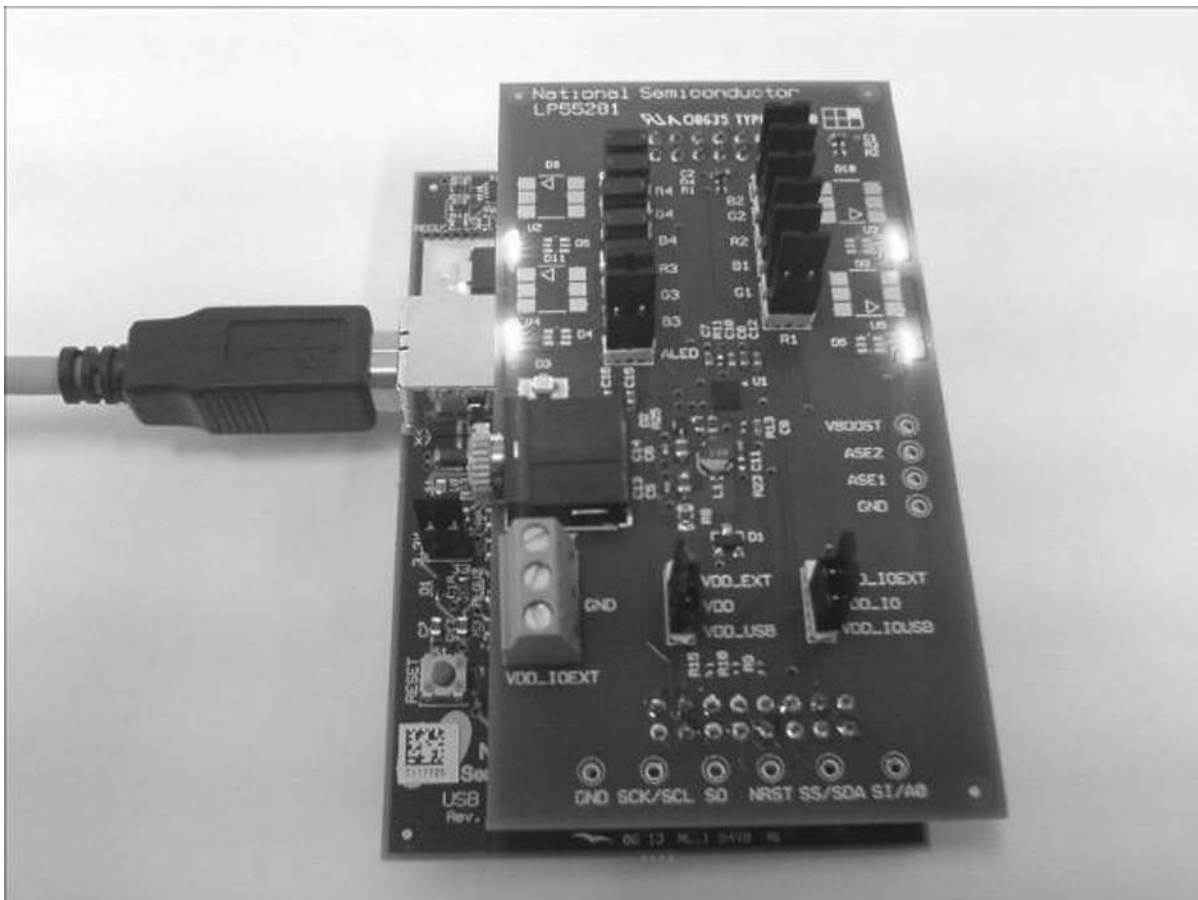

**Figure 1. LP55281 Evaluation Board with USB Interface Board**

## 2 Evaluation Kit Overview

LP55281 Evaluation Kit is based on a modular system, where the actual evaluation board is plugged on top of the PC interface board. The interface operates through the USB port. The kit supports complete functional evaluation of the circuit. The evaluation kit consists of:

- LP55281 evaluation board
- USB interface board
- USB interface cable
- Audio cable and 3.5mm branch plug
- CD including:
  - Evaluation software for PC
  - LP55281 datasheet
  - DSBGA package - YZR0036 Wafer Level Chip Scale Package [SNVA009](#)
  - DSBGExt package - YPG0036 Wafer Level Chip Scale Package [SNVA131](#)
  - PCB design application note AN1149 ([SNVA021](#))
  - Evaluation kit document (this doc.)

### 3 Evaluation Software

LP55281 evaluation software and some support files are supplied on the delivery CD together with all available documentation regarding the circuit. You can copy the software and the files to your PC's hard disk. The program and the support files must be in the same folder. The software is started by double-clicking its icon. The software does not require any installation.

This document describes the use of the LP55281.exe program.

The evaluation software is organized in tabs according to the main functions of the chip. On the left side of the tabs, see Figure 2, is shown the entire register map of LP55281. Below the tabs are shown the registers, which are affected by the selected tab. Both register displays reflect immediately the changes you make by clicking the selection boxes or sliders in the tabs. The contents of the tabs should be mostly self-explanatory. One example register settings are included in the delivery CD and they can be loaded from the File/Open menu. You can similarly save your own settings.

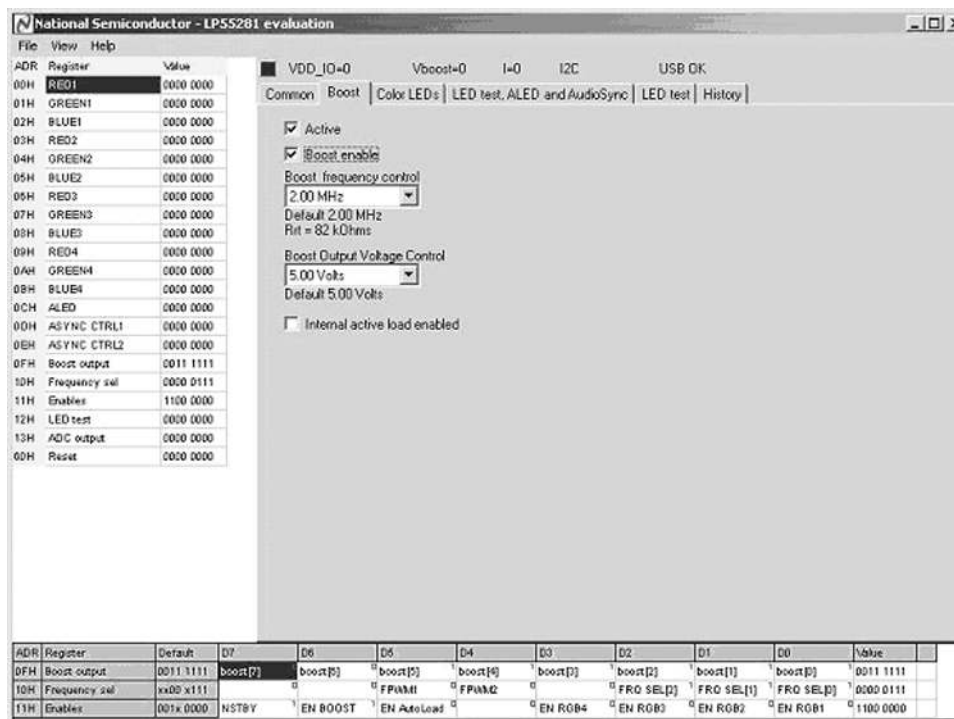

Figure 2. LP55281 Evaluation Software User Interface

### 3.1 Common Tab

The Common Tab, [Figure 3](#), contains evaluation board control functions. Automatic writing (Update registers immediately) is enabled by default. It means that a write operation is done after every mouse click. If you want to change several settings in one or more tabs and write the register(s) after making all the changes, you can disable automatic writing. Then after the changes you have to initiate the register write by clicking the right mouse key with the cursor in the Register Map area. From the pop-up menu, you can choose to write all registers or just a selected register. The same pop-up lets you write default values to one or all registers and read one or all registers.

Interface can be selected between I<sup>2</sup>C and SPI. For I<sup>2</sup>C there are two addresses available, 0x4C and 0x4D. Interface port is always USB.

The regulated voltage supplied from the USB board can be set to 3.0 or 3.9V. The raw voltage from the USB port is 5V and maximum current is 500mA. By changing jumper J1 on the USB board to 5V position the raw voltage is connected to the evaluation board and power from USB board can be maximally used for LEDs.

USB board can measure voltages from the evaluation board. On the LP55281 board the circuit  $V_{DDIO}$  and the converter output voltage  $V_{BOOST}$  are measured. The current supplied by the USB board to the evaluation board is measured. Measurement is enabled, when the Polling interval in the Common tab is set. Measurement results are shown on top of the window.

Device can be reset by hard reset or by soft reset. Soft reset writes to register 0x60.

By checking the debug mode you can write or read data directly to or from addresses given in Direct Access field.

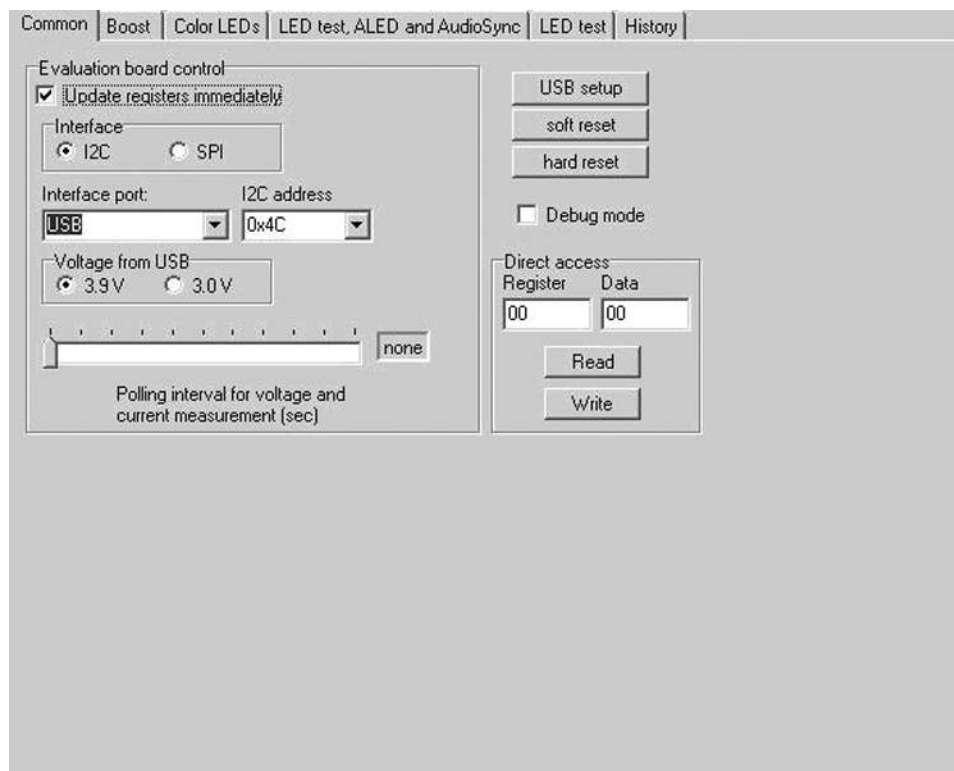

**Figure 3. Common Tab**

### 3.2 Boost Tab

Boost is enabled in the Boost tab, [Figure 4](#), by checking the boost enable. The internal active load can be enabled to eliminate pulse skipping of the boost converter. Active load will consume some power when the boost output current is small. It will decrease efficiency at very light load conditions. Also the boost PWM frequency and output voltage is set here. One can also enable the Boost internal active load.

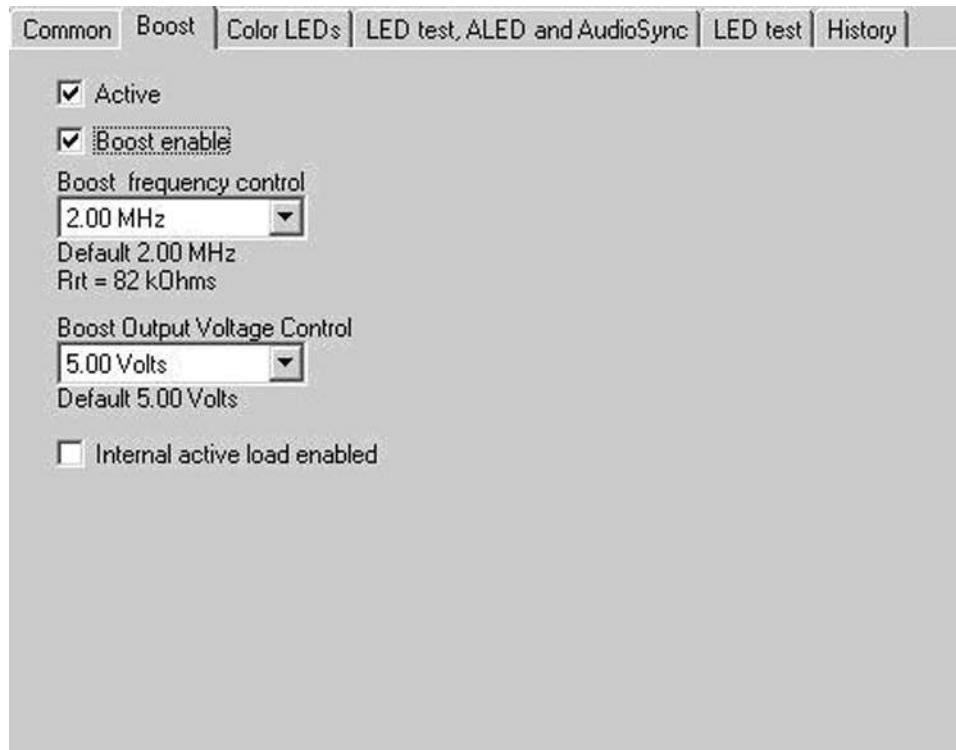

Figure 4. Boost Tab

### 3.3 Color LEDs Tab

For each RGB LED, there is its own subtab in the Color LEDs tab, [Figure 5](#). In each subtab (RGB1-4) you can enable the RGB, set its PWM with the slider and select its current from the drop-down menu.

The Max current selection can be used to show the required current set resistor value for a given LED current. It doesn't control the current in any way.

The PWM frequency can be controlled in this tab also.

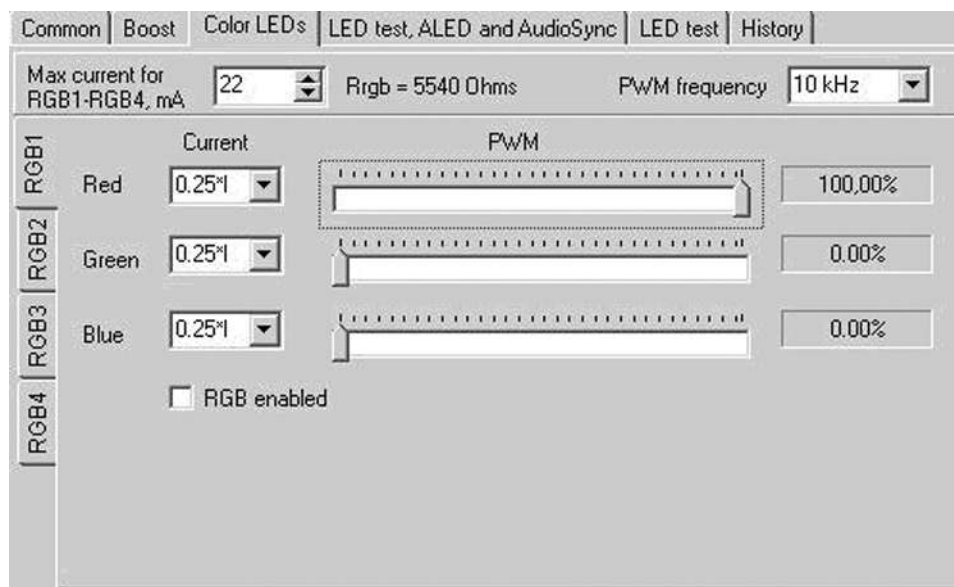

Figure 5. Color LEDs Tab

### 3.4 LED Test, ALED and Audio Synchronization Tab

In this tab, [Figure 6](#), LED test, ALED and Audio Sync are controlled.

LED test can be done automatically with LED Auto Test by pushing Start button. Test will go thru all the leds and indicate if they are connected or not. LED test can be done by using ADC also. Test is enabled by checking the Test enable box. Desired LED is chosen from pull-down menu and value can be read by pushing the Read ADC button. Note that LED test will not work correctly unless the PWM of the LED under test is 100%. Also the LED current should be at minimum.

ALED current is controlled with Current slider. Below the slider is the Audio synchronization enable box, which sets the ALED into Audio Sync. mode.

With audio synchronization controls, you can enable the Automatic Gain Control, set gain control level manually, select Speed from pull-down menu, select DC filter between 80 Hz or 510 Hz and set the Threshold.

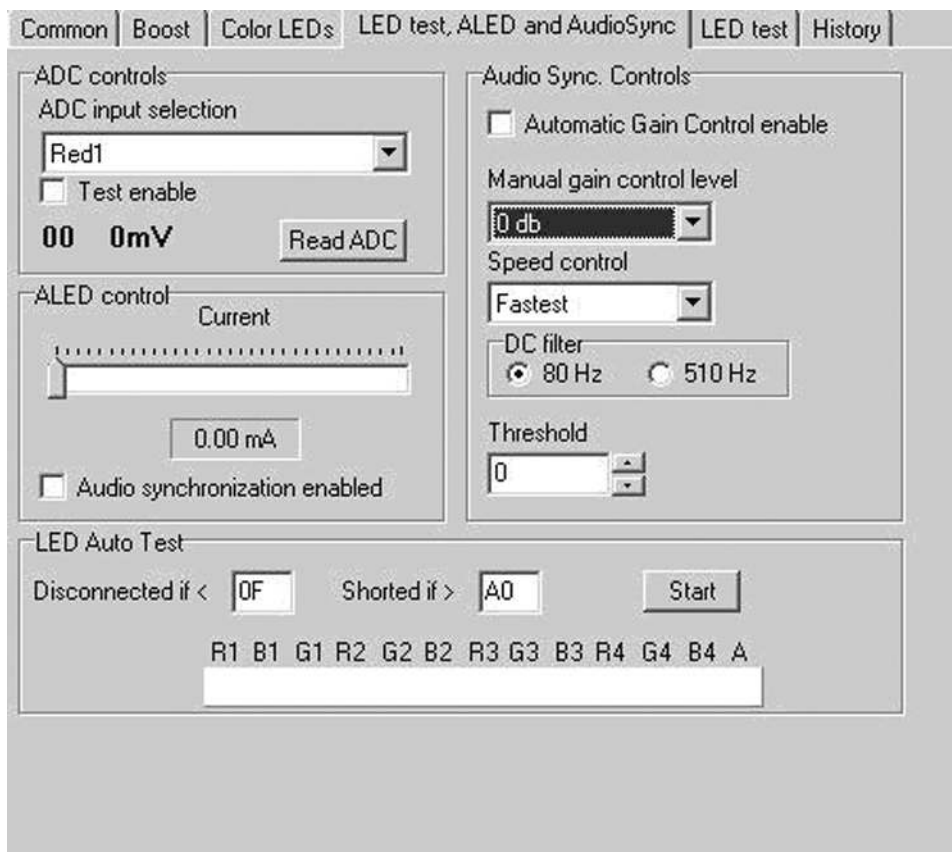
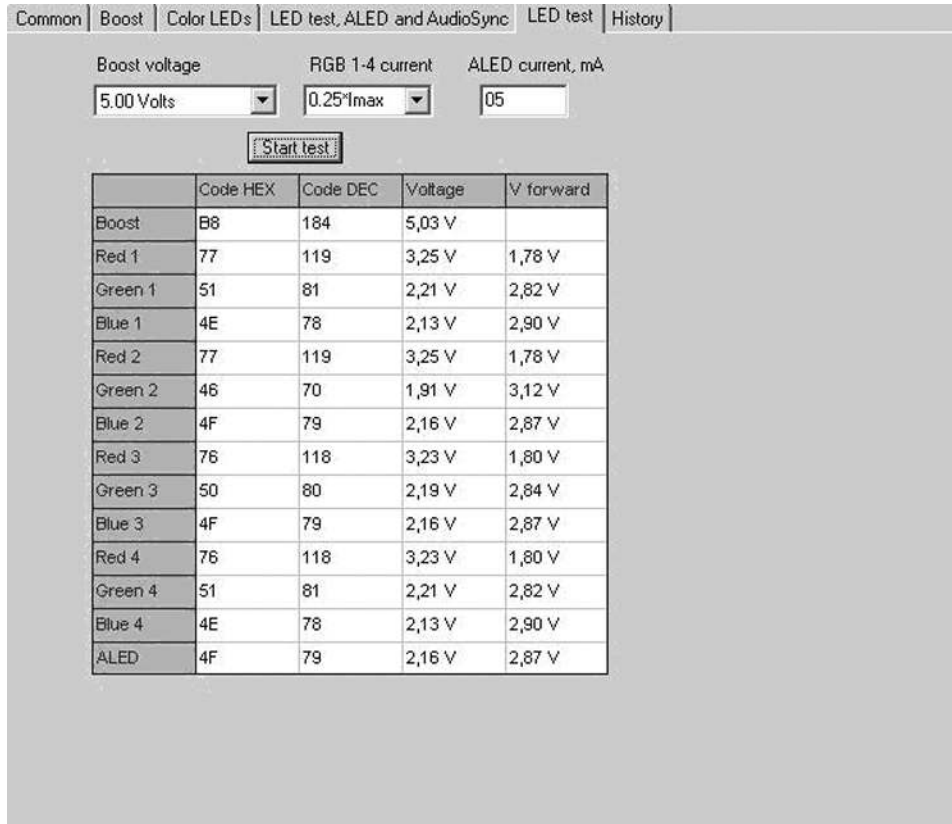

Figure 6. LED Test, ALED and Audio Sync Tab

### 3.5 LED Test Tab

In LED test tab, [Figure 7](#), all the LEDs are tested with one press of a button. You can set Boost voltage, RGB 1-4 currents and ALED current. After pressing Start, test program automatically tests all the LEDs and Boost voltage. Results are displayed on a table with ADC code, both in HEX and in DEC, voltages and forward voltages for the LEDs.

After performing the LED test, the device is reset and have to be put to active mode again. Also the boost is disabled. The RGB LEDs PWM value is set to 100%, RGB current values, ALED current and Boost voltage are set as you have chosen.



	Code HEX	Code DEC	Voltage	V forward
Boost	B8	184	5,03 V	
Red 1	77	119	3,25 V	1,78 V
Green 1	51	81	2,21 V	2,82 V
Blue 1	4E	78	2,13 V	2,90 V
Red 2	77	119	3,25 V	1,78 V
Green 2	46	70	1,91 V	3,12 V
Blue 2	4F	79	2,16 V	2,87 V
Red 3	76	118	3,23 V	1,80 V
Green 3	50	80	2,19 V	2,84 V
Blue 3	4F	79	2,16 V	2,87 V
Red 4	76	118	3,23 V	1,80 V
Green 4	51	81	2,21 V	2,82 V
Blue 4	4E	78	2,13 V	2,90 V
ALED	4F	79	2,16 V	2,87 V

**Figure 7. LED Test Tab**



### 3.6 History Tab

The History Tab, [Figure 8](#), records the command sequence of your session. You can copy-paste this information to another application if you wish.

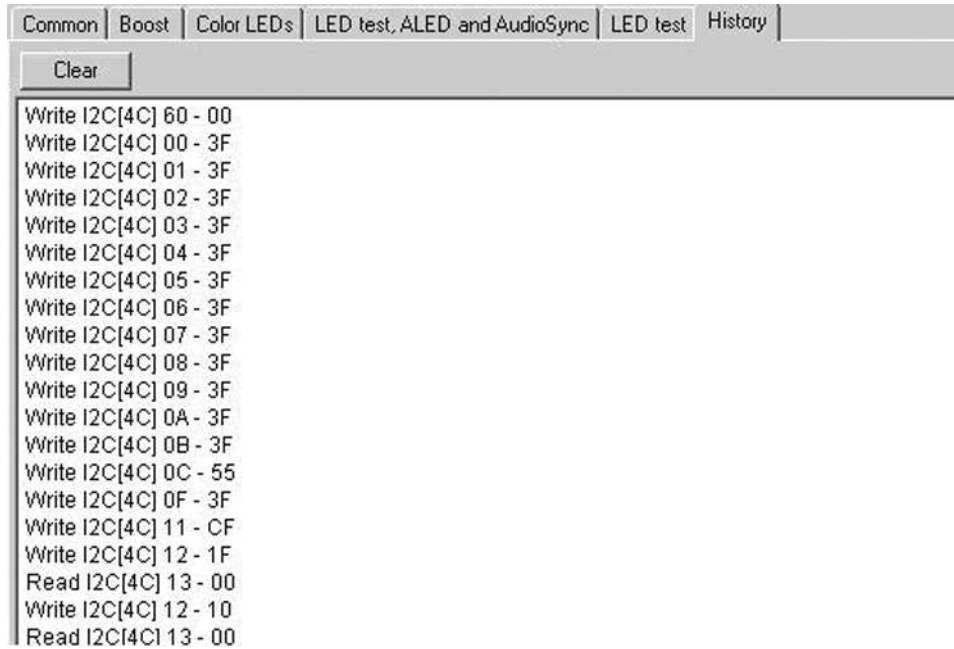

**Figure 8. History Tab**

## 4 Evaluation Hardware

The evaluation board, [Figure 9](#), has the LP55281 circuit with the necessary external components placed around it. Test points for the circuit pins are on the board edges. LEDs are on the right and left side of the board (there are places for different types of LEDs). The power and audio connector is on the left side of the board. Two PCB connectors make the connection to the USB interface board or some other controller if needed.

The supply voltage  $V_{DD}$ , ground GND and I/O-voltage  $V_{DDIO}$  can be connected to the green power connector. When the USB interface is used, the  $V_{DD}$  and  $V_{DDIO}$  can be either supplied from external power or from the USB board.

The evaluation board makes possible to use the circuit in normal mode and in 7V tolerant mode. 2.8V LDO on the board provides the  $V_{DD}$  for the circuit in 7V tolerant mode. If 7V is used, the 6.2V protection zener diode on the solder side of the board should be removed.

There are jumpers on the board for connecting  $V_{BOOST}$  to each set of LEDs.

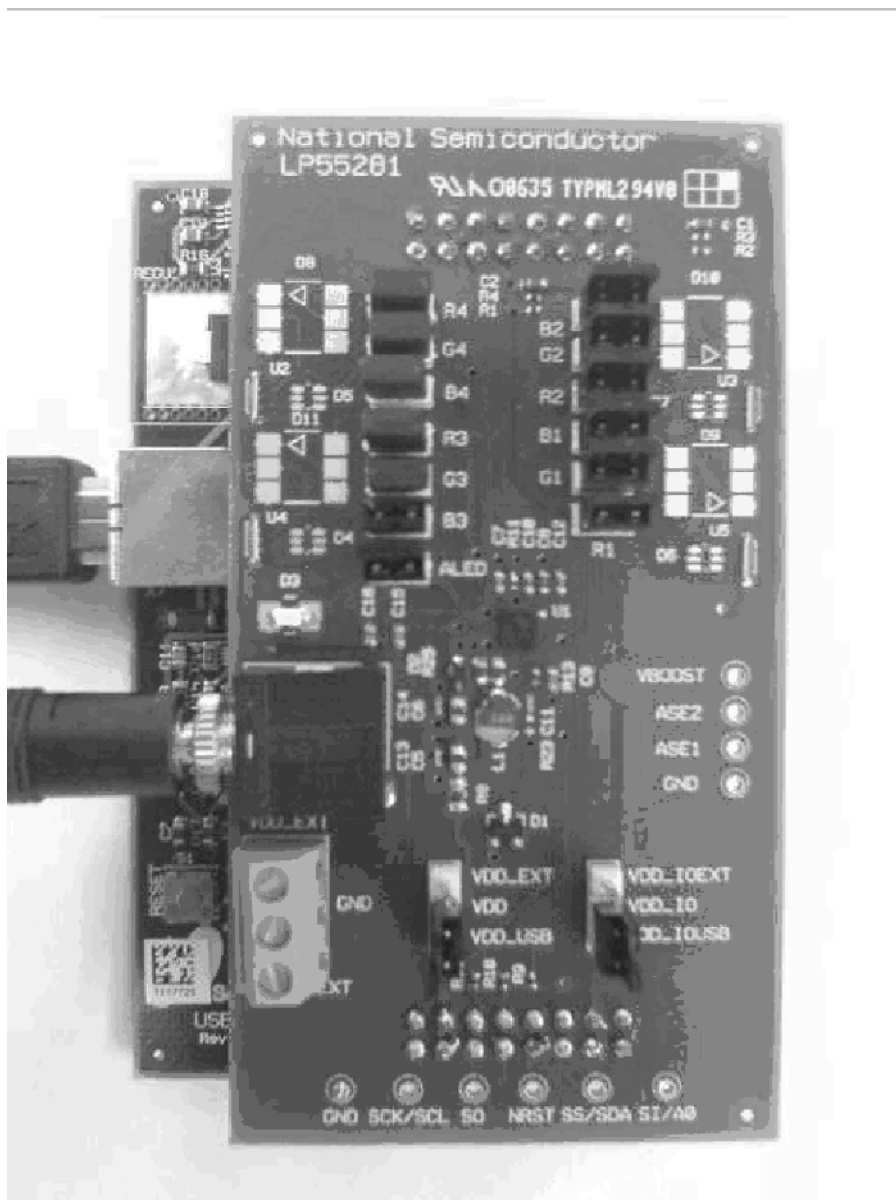

**Figure 9. LP55281 Evaluation Board**

## 5 USB Interface

The USB interface, [Figure 10](#), forms the connection between the PC and the evaluation system. It converts the commands from PC to I<sup>2</sup>C or SPI format. It also provides adjustable supply voltage for the evaluation board and makes possible to measure selected voltages and the input current in the evaluation board.

The USB interface checks for the firmware version of the USB board when the evaluation software is started. If the firmware needs updating, the software prompts you to allow automatic update.

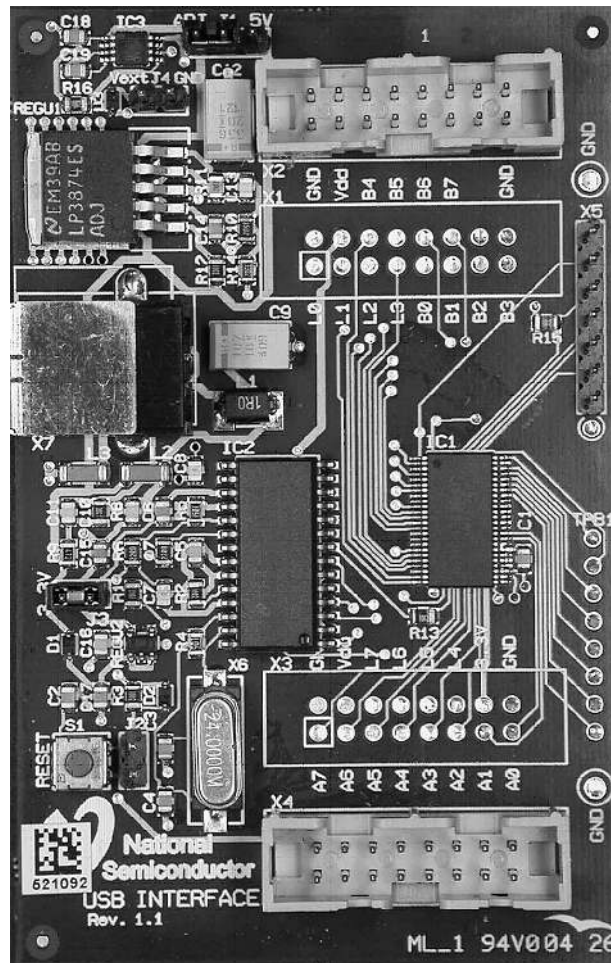

Figure 10. USB Interface Board

## 6 Getting Started

The following instructions show how to use the LP55281 evaluation kit in default conditions with the USB interface board. Please use the ESD protection (ground cable) to prevent any unwanted damaging ESD events.

1. Check the jumpers and switches on the board.
2. Plug in the evaluation board to the USB board. Connect the USB cable to the evaluation board and to the USB port of your PC. When you plug in the USB board for the first time, your operating system prompts you about "New hardware found" and installs the USB driver. With Win95 and Win98 operating systems you have to accept the installation and click "Next" several times as the installation proceeds.
3. Copy the evaluation software and the support files to your PC's hard disk. Start the software by double-clicking its icon.
4. Press Hardware Reset and USB Setup buttons to reset the chip and the USB interface board.
5. Turn on the chip and the boost converter by enabling stand-by and boost.
6. The Evaluation Kit is now ready to use and the chip can be controlled through the PC-software.

You should disconnect the USB cable from the computer always, when plugging in or removing the evaluation board from the interface board and also when changing the supply jumper settings. Otherwise the USB board may stop responding.

If the USB board is not responding or the software hangs up, press the reset button on the USB board, or disconnect the USB cable for 5 seconds.

If the evaluation software notices that the firmware on the USB board needs to be updated, the software can propose automatic firmware updating. The new firmware will be included in the evaluation kit software.

## 7 List of Main Components

Part Number	Qty	Value, Size, Tolerance	Description	Vendor/Type
L1	1	4.7 $\mu$ H	Power Inductor	TDK VLF4012A-SMD
D8-D11	4		RGB 3-Color LEDs	Sharp GM5WA06270A-SMD
D1	1		Zener Diode	BZX84C5V6-ZENER-SOT23
D2	1		Schottky Barrier Diode	Philips BAT760-SOD323
C5, C6	2	10 $\mu$ F, 0805, 10%	10V Capacitor	

## 8 Schematic of the Evaluation Board

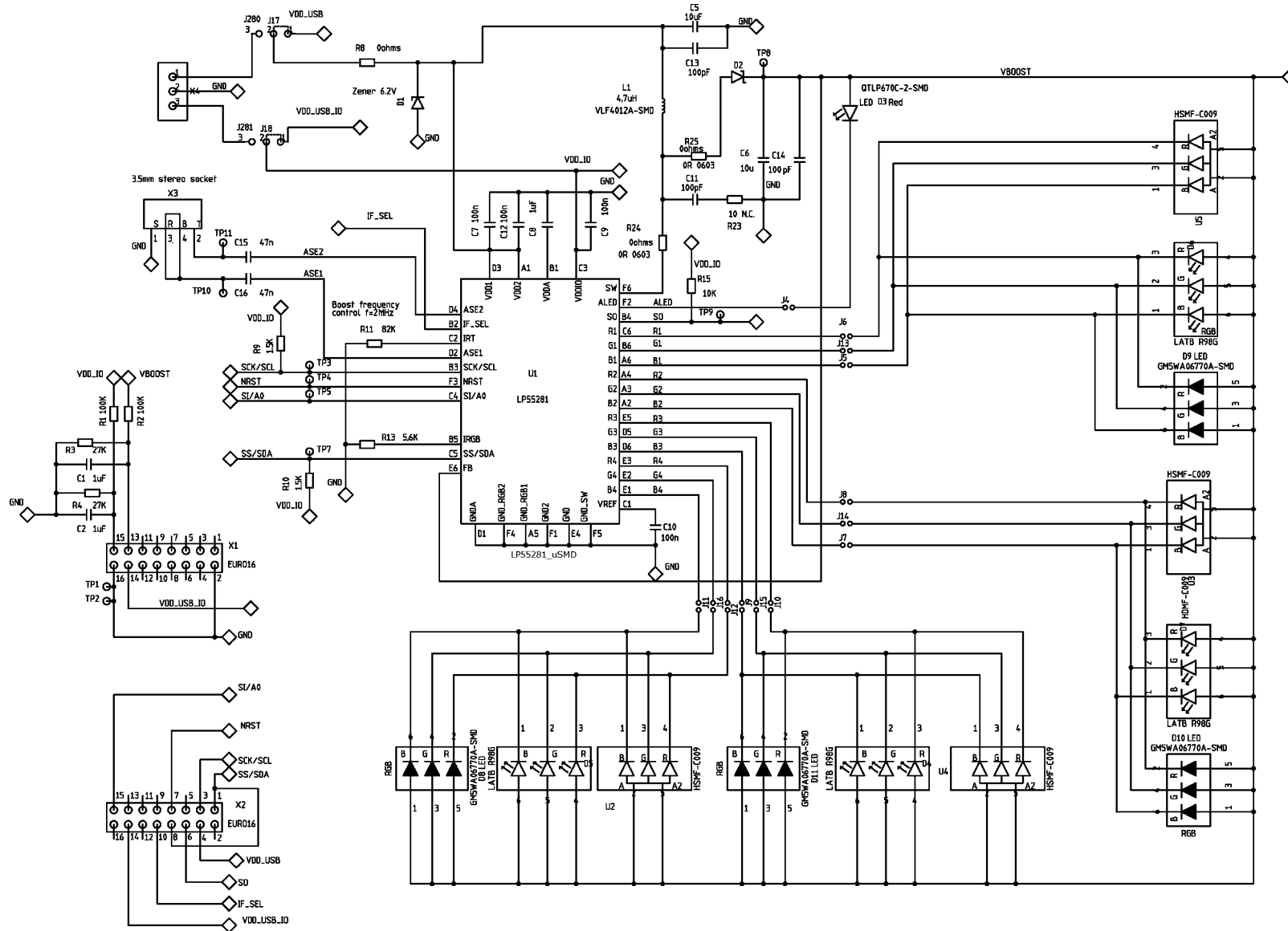

Figure 11. LP55281 Evaluation Board Schematic

## IMPORTANT NOTICE

Texas Instruments Incorporated and its subsidiaries (TI) reserve the right to make corrections, enhancements, improvements and other changes to its semiconductor products and services per JESD46, latest issue, and to discontinue any product or service per JESD48, latest issue. Buyers should obtain the latest relevant information before placing orders and should verify that such information is current and complete. All semiconductor products (also referred to herein as "components") are sold subject to TI's terms and conditions of sale supplied at the time of order acknowledgment.

TI warrants performance of its components to the specifications applicable at the time of sale, in accordance with the warranty in TI's terms and conditions of sale of semiconductor products. Testing and other quality control techniques are used to the extent TI deems necessary to support this warranty. Except where mandated by applicable law, testing of all parameters of each component is not necessarily performed.

TI assumes no liability for applications assistance or the design of Buyers' products. Buyers are responsible for their products and applications using TI components. To minimize the risks associated with Buyers' products and applications, Buyers should provide adequate design and operating safeguards.

TI does not warrant or represent that any license, either express or implied, is granted under any patent right, copyright, mask work right, or other intellectual property right relating to any combination, machine, or process in which TI components or services are used. Information published by TI regarding third-party products or services does not constitute a license to use such products or services or a warranty or endorsement thereof. Use of such information may require a license from a third party under the patents or other intellectual property of the third party, or a license from TI under the patents or other intellectual property of TI.

Reproduction of significant portions of TI information in TI data books or data sheets is permissible only if reproduction is without alteration and is accompanied by all associated warranties, conditions, limitations, and notices. TI is not responsible or liable for such altered documentation. Information of third parties may be subject to additional restrictions.

Resale of TI components or services with statements different from or beyond the parameters stated by TI for that component or service voids all express and any implied warranties for the associated TI component or service and is an unfair and deceptive business practice. TI is not responsible or liable for any such statements.

Buyer acknowledges and agrees that it is solely responsible for compliance with all legal, regulatory and safety-related requirements concerning its products, and any use of TI components in its applications, notwithstanding any applications-related information or support that may be provided by TI. Buyer represents and agrees that it has all the necessary expertise to create and implement safeguards which anticipate dangerous consequences of failures, monitor failures and their consequences, lessen the likelihood of failures that might cause harm and take appropriate remedial actions. Buyer will fully indemnify TI and its representatives against any damages arising out of the use of any TI components in safety-critical applications.

In some cases, TI components may be promoted specifically to facilitate safety-related applications. With such components, TI's goal is to help enable customers to design and create their own end-product solutions that meet applicable functional safety standards and requirements. Nonetheless, such components are subject to these terms.

No TI components are authorized for use in FDA Class III (or similar life-critical medical equipment) unless authorized officers of the parties have executed a special agreement specifically governing such use.

Only those TI components which TI has specifically designated as military grade or "enhanced plastic" are designed and intended for use in military/aerospace applications or environments. Buyer acknowledges and agrees that any military or aerospace use of TI components which have **not** been so designated is solely at the Buyer's risk, and that Buyer is solely responsible for compliance with all legal and regulatory requirements in connection with such use.

TI has specifically designated certain components as meeting ISO/TS16949 requirements, mainly for automotive use. In any case of use of non-designated products, TI will not be responsible for any failure to meet ISO/TS16949.

### Products

Audio	<a href="http://www.ti.com/audio">www.ti.com/audio</a>
Amplifiers	<a href="http://amplifier.ti.com">amplifier.ti.com</a>
Data Converters	<a href="http://dataconverter.ti.com">dataconverter.ti.com</a>
DLP® Products	<a href="http://www.dlp.com">www.dlp.com</a>
DSP	<a href="http://dsp.ti.com">dsp.ti.com</a>
Clocks and Timers	<a href="http://www.ti.com/clocks">www.ti.com/clocks</a>
Interface	<a href="http://interface.ti.com">interface.ti.com</a>
Logic	<a href="http://logic.ti.com">logic.ti.com</a>
Power Mgmt	<a href="http://power.ti.com">power.ti.com</a>
Microcontrollers	<a href="http://microcontroller.ti.com">microcontroller.ti.com</a>
RFID	<a href="http://www.ti-rfid.com">www.ti-rfid.com</a>
OMAP Applications Processors	<a href="http://www.ti.com/omap">www.ti.com/omap</a>
Wireless Connectivity	<a href="http://www.ti.com/wirelessconnectivity">www.ti.com/wirelessconnectivity</a>

### Applications

Automotive and Transportation	<a href="http://www.ti.com/automotive">www.ti.com/automotive</a>
Communications and Telecom	<a href="http://www.ti.com/communications">www.ti.com/communications</a>
Computers and Peripherals	<a href="http://www.ti.com/computers">www.ti.com/computers</a>
Consumer Electronics	<a href="http://www.ti.com/consumer-apps">www.ti.com/consumer-apps</a>
Energy and Lighting	<a href="http://www.ti.com/energy">www.ti.com/energy</a>
Industrial	<a href="http://www.ti.com/industrial">www.ti.com/industrial</a>
Medical	<a href="http://www.ti.com/medical">www.ti.com/medical</a>
Security	<a href="http://www.ti.com/security">www.ti.com/security</a>
Space, Avionics and Defense	<a href="http://www.ti.com/space-avionics-defense">www.ti.com/space-avionics-defense</a>
Video and Imaging	<a href="http://www.ti.com/video">www.ti.com/video</a>

### TI E2E Community

[e2e.ti.com](http://e2e.ti.com)