

DRV2665 Piezo Haptic Driver with Integrated Boost Converter and Digital Front End

1 Features

- Integrated Digital Front End
 - Up to 400-kHz I²C Bus Control
 - 100-Byte Internal FIFO Interface
 - Immersion TS5000-Compliant
 - Optional Analog Inputs
- High Voltage Piezo-Haptic Driver
 - Drives up to 100 nF at 200 V_{PP} and 300 Hz
 - Drives up to 150 nF at 150 V_{PP} and 300 Hz
 - Drives up to 330 nF at 100 V_{PP} and 300 Hz
 - Drives up to 680 nF at 50 V_{PP} and 300 Hz
 - Differential Output
- 105-V Integrated Boost Converter
 - Adjustable Boost Voltage
 - Adjustable Boost Current Limit
 - Integrated Power FET and Diode
 - No Transformer Required
- 2-ms Fast Start Up Time
- 3.3- to 5.5-V Wide Supply Voltage Range
- 1.8-V Compatible, V_{DD} Tolerant Digital Pins

2 Applications

- Mobile Phones
- Tablets
- Portable Computers
- Keyboards and Mice
- Electronic Gaming
- Touch Enabled Devices

3 Description

The DRV2665 device is a piezo haptic driver with integrated 105-V boost switch, integrated power diode, integrated fully-differential amplifier, and integrated digital front end. This versatile device is capable of driving both high-voltage and low-voltage piezo haptic actuators. The input signal can be driven as haptic packets over the I²C port or through the analog inputs.

The digital interface of the DRV2665 device is available through an I²C compatible bus. A digital interface relieves the costly processor burden of the PWM generation or additional analog channel requirements in the host system. Any writes to the internal first-in, first-out buffer (FIFO) will automatically wake up the device and begin playing the waveform after the 2 ms internal start-up procedure. When the data flow stops or the FIFO under-runs, the DRV2665 device will automatically enter a pop-less shutdown procedure.

The boost voltage is set using two external resistors, and the boost current limit is programmable through the R_{EXT} resistor. A typical start-up time of 2 ms makes the DRV2665 device an ideal piezo driver for fast haptic responses. Thermal overload protection prevents the device from being damaged when overdriven.

Device Information⁽¹⁾

PART NUMBER	PACKAGE	BODY SIZE (MAX)
DRV2665	QFN (20)	4.00 mm × 4.00 mm

(1) For all available packages, see the orderable addendum at the end of the data sheet.

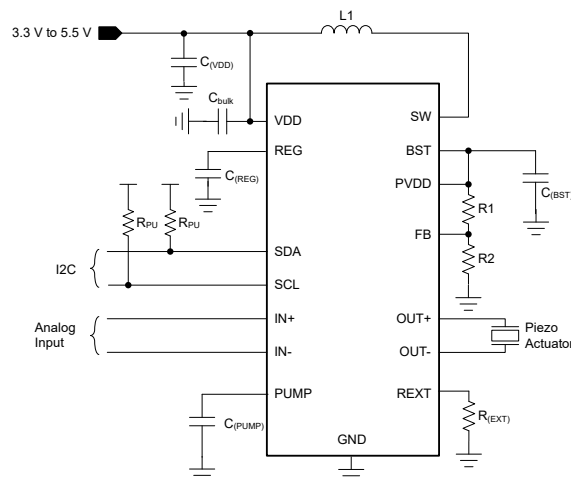

Simplified Schematic



Table of Contents

1 Features	1	7.3 Feature Description.....	10
2 Applications	1	7.4 Device Functional Modes.....	13
3 Description	1	7.5 Programming.....	14
4 Revision History	2	7.6 Register Map.....	18
5 Pin Configuration and Functions	3	8 Application and Implementation	21
6 Specifications	4	8.1 Application Information.....	21
6.1 Absolute Maximum Ratings.....	4	8.2 Typical Application.....	22
6.2 ESD Ratings.....	4	8.3 Initialization Setup.....	24
6.3 Recommended Operating Conditions.....	4	9 Power Supply Recommendations	24
6.4 Thermal Information.....	4	10 Layout	25
6.5 Electrical Characteristics.....	5	10.1 Layout Guidelines.....	25
6.6 Timing Requirements.....	6	10.2 Layout Example.....	25
6.7 Switching Characteristics.....	6	11 Device and Documentation Support	26
6.8 Typical Characteristics.....	8	11.1 Community Resources.....	26
7 Detailed Description	10	11.2 Trademarks.....	26
7.1 Overview.....	10	12 Mechanical, Packaging, and Orderable Information	26
7.2 Functional Block Diagram.....	10		

4 Revision History

NOTE: Page numbers for previous revisions may differ from page numbers in the current version.

Changes from Revision B (September 2015) to Revision C (January 2023)	Page
• Changed V_{DD} MIN spec from 3.0 to 3.3.....	4
Changes from Revision A (January 2014) to Revision B (September 2015)	Page
• Added <i>ESD Ratings</i> table, <i>Feature Description</i> section, <i>Device Functional Modes</i> section, <i>Application and Implementation</i> section, <i>Power Supply Recommendations</i> section, <i>Layout</i> section, <i>Device and Documentation Support</i> section, and <i>Mechanical, Packaging, and Orderable Information</i> section.	1
• Added Exception description to Section 7.3.11.3 section.....	12
Changes from Revision * (May 2012) to Revision A (January 2014)	Page
• Changed from one-page data sheet to full data sheet in product folder.....	1

5 Pin Configuration and Functions

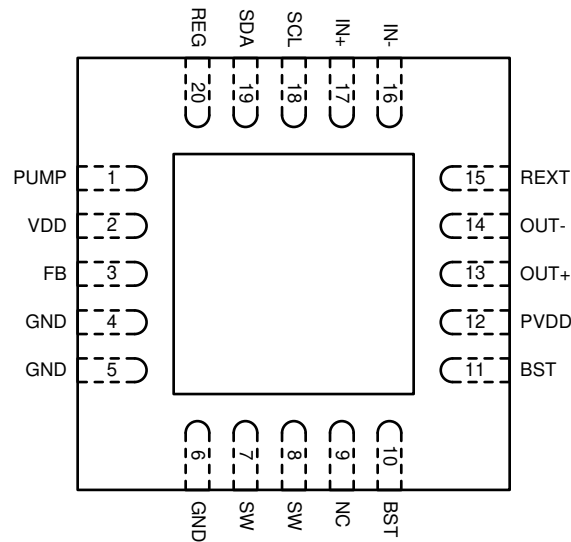

Figure 5-1. RGP Package 20-Pin QFN With Exposed Thermal Pad Top View

Table 5-1. Pin Functions

PIN		TYPE	DESCRIPTION
NAME	NO. ¹		
PUMP	1	P	Internal charge pump voltage
VDD	2	P	3- to 5.5-V supply input. A 1 μ F-capacitor is required.
FB	3	I	Boost feedback
GND	4, 5, 6	P	Supply ground
SW	7, 8	P	Internal boost switch pin
NC	9	—	No connect
BST	10, 11	P	Boost output voltage. A 0.1- μ F capacitor is required.
PVDD	12	P	High-voltage amplifier input voltage
OUT+	13	O	Positive haptic driver differential output
OUT-	14	O	Negative haptic driver differential output
REXT	15	I	Sets boost current limit. Resistor to ground.
IN-	16	I	Negative analog input
IN+	17	I	Positive analog input
SCL	18	I	I ² C clock
SDA	19	I/O	I ² C data
REG	20	O	1.8-V regulator output. A 0.1- μ F capacitor is required.

1. I = Input, O = Output, P = Power

6 Specifications

6.1 Absolute Maximum Ratings

over operating free-air temperature range (unless otherwise noted)⁽¹⁾

		MIN	MAX	UNIT
Supply Voltage, V_{DD}		-0.3	6	V
Input voltage, V_I	SDA, SCL, IN+, IN-, FB	-0.3	$V_{DD} + 0.3$	V
Boost voltage	BST, SW, OUT+, OUT-, PVDD	-0.3	120	V
Operating free-air temperature, T_A		-40	70	°C
Operating junction temperature, T_J		-40	150	°C
Storage temperature, T_{stg}		-65	85	°C

- (1) Stresses beyond those listed under *Absolute Maximum Ratings* may cause permanent damage to the device. These are stress ratings only, which do not imply functional operation of the device at these or any other conditions beyond those indicated under *Recommended Operating Conditions*. Exposure to absolute-maximum-rated conditions for extended periods may affect device reliability.

6.2 ESD Ratings

		VALUE	UNIT
$V_{(ESD)}$ Electrostatic discharge	Human body model (HBM), per ANSI/ESDA/JEDEC JS-001 ⁽¹⁾	±2500	V
	Charged device model (CDM), per JEDEC specification JESD22-C101 ⁽²⁾	±500	

- (1) JEDEC document JEP155 states that 500-V HBM allows safe manufacturing with a standard ESD control process.
(2) JEDEC document JEP157 states that 250-V CDM allows safe manufacturing with a standard ESD control process.

6.3 Recommended Operating Conditions

over operating free-air temperature range (unless otherwise noted)

		MIN	NOM	MAX	UNIT
V_{DD}	Supply voltage	3.3		5.5	V
V_{BST}	Boost voltage	15		105	V
V_{IN}	Differential input voltage		1.8		V
C_L	Load capacitance	$V_{BST} = 105$ V, Frequency = 500 Hz, $V_{OUT} = 200$ V _{PP}		50	nF
		$V_{BST} = 105$ V, Frequency = 300 Hz, $V_{OUT} = 200$ V _{PP}		100	
		$V_{BST} = 80$ V, Frequency = 300 Hz, $V_{OUT} = 150$ V _{PP}		150	
		$V_{BST} = 55$ V, Frequency = 300 Hz, $V_{OUT} = 100$ V _{PP}		330	
		$V_{BST} = 30$ V, Frequency = 300 Hz, $V_{OUT} = 50$ V _{PP}		680	
		$V_{BST} = 25$ V, Frequency = 300 Hz, $V_{OUT} = 40$ V _{PP}		1000	
		$V_{BST} = 15$ V, Frequency = 300 Hz, $V_{OUT} = 20$ V _{PP}		3000	
R_{EXT}	Current limit control resistor	6		35	kΩ
L	Inductance for boost converter	3.3			μH

6.4 Thermal Information

THERMAL METRIC ⁽¹⁾		DRV2665	UNIT
		RGP (QFN)	
		20 PINS	
$R_{\theta JA}$	Junction-to-ambient thermal resistance	32.6	°C/W
$R_{\theta JC(top)}$	Junction-to-case (top) thermal resistance	30.4	°C/W
$R_{\theta JB}$	Junction-to-board thermal resistance	8.2	°C/W
ψ_{JT}	Junction-to-top characterization parameter	0.4	°C/W
ψ_{JB}	Junction-to-board characterization parameter	8.1	°C/W

THERMAL METRIC ⁽¹⁾		DRV2665	UNIT
		RGP (QFN)	
		20 PINS	
R _{θJC(bot)}	Junction-to-case (bottom) thermal resistance	2.2	°C/W

(1) For more information about traditional and new thermal metrics, see the *Semiconductor and IC Package Thermal Metrics* application report, [SPRA953](#).

6.5 Electrical Characteristics

T_A = 25 °C, V_{DD} = 3.6 V (unless otherwise noted)

PARAMETER		TEST CONDITIONS	MIN	TYP	MAX	UNIT
V _{REG}	Voltage at the REG pin		1.6	1.75	1.9	V
I _{IL}	Digital low-level input current	SDA, SCL V _{DD} = 3.6 V, V _I = 0 V			1	μA
I _{IH}	Digital high-level input current	SDA, SCL V _{DD} = 3.6 V, V _I = V _{DD}			1	μA
V _{IL}	Digital low-level input voltage	SDA, SCL V _{DD} = 3.6 V			0.5	V
V _{IH}	Digital high-level input voltage	SDA, SCL V _{DD} = 3.6 V	1.4			V
V _{OL}	Digital low-level output voltage	SDA 3-mA sink current			0.4	V
I _{SD}	Shutdown current	V _{DD} = 3.6 V, STANDBY = 1		10		μA
I _Q	Quiescent current	Digital mode	V _{DD} = 3.6 V, STANDBY = 0	130	175	μA
		Analog mode	V _{DD} = 3.6 V, analog input mode, V _{BST} = 105 V	24		mA
			V _{DD} = 3.6 V, analog input mode, V _{BST} = 80 V	13		
			V _{DD} = 3.6 V, analog input mode, V _{BST} = 50 V	9		
			V _{DD} = 3.6 V, analog input mode, V _{BST} = 30 V	5		
R _{IN}	Input impedance	IN+, IN-; All gains		100		kΩ
V _{OUT(FS)}	Full-scale output voltage (digital mode)	GAIN[1:0] = 00	49	50	51	V _{PP}
		GAIN[1:0] = 01	98	100	102	
		GAIN[1:0] = 10	147	150	153	
		GAIN[1:0] = 01	196	200	204	
V _{OUT(OS)}	Output offset	All gains	-0.25		0.25	V
BW	Amplifier bandwidth	GAIN[1:0] = 00, V _{OUT} = 50 V _{PP} , no load		20		kHz
		GAIN[1:0] = 01, V _{OUT} = 100 V _{PP} , no load		10		
		GAIN[1:0] = 10, V _{OUT} = 150 V _{PP} , no load		7.5		
		GAIN[1:0] = 11, V _{OUT} = 200 V _{PP} , no load		5		

$T_A = 25\text{ }^\circ\text{C}$, $V_{DD} = 3.6\text{ V}$ (unless otherwise noted)

PARAMETER	TEST CONDITIONS	MIN	TYP	MAX	UNIT
$I_{BAT,AVG}$ Average battery current during operation	$C_L = 220\text{ nF}$, $f = 200\text{ Hz}$, $V_{BST} = 30\text{ V}$, $GAIN[1:0] = 00$, $V_{OUT} = 50\text{ V}_{PP}$		69		mA
	$C_L = 680\text{ nF}$, $f = 150\text{ Hz}$, $V_{BST} = 30\text{ V}$, $GAIN[1:0] = 00$, $V_{OUT} = 50\text{ V}_{PP}$		75		
	$C_L = 680\text{ nF}$, $f = 300\text{ Hz}$, $V_{BST} = 30\text{ V}$, $GAIN[1:0] = 00$, $V_{OUT} = 50\text{ V}_{PP}$		115		
	$C_L = 22\text{ nF}$, $f = 200\text{ Hz}$, $V_{BST} = 80\text{ V}$, $GAIN[1:0] = 10$, $V_{OUT} = 150\text{ V}_{PP}$		67		
	$C_L = 47\text{ nF}$, $f = 150\text{ Hz}$, $V_{BST} = 105\text{ V}$, $GAIN[1:0] = 11$, $V_{OUT} = 200\text{ V}_{PP}$		210		
	$C_L = 47\text{ nF}$, $f = 300\text{ Hz}$, $V_{BST} = 105\text{ V}$, $GAIN[1:0] = 11$, $V_{OUT} = 200\text{ V}_{PP}$		400		
THD+N Total harmonic distortion plus noise	$f = 300\text{ Hz}$, $V_{OUT} = 200\text{ V}_{PP}$		1%		
f_S Output sample rate	Digital playback engine sample rate	7.8	8	8.05	kHz

6.6 Timing Requirements

 $T_A = 25\text{ }^\circ\text{C}$, $V_{DD} = 3.6\text{ V}$ (unless otherwise noted). For timing diagrams, see [Figure 6-1](#) and [Figure 6-2](#).

		MIN	NOM	MAX	UNIT
f_{SCL} Frequency at the SCL pin with no wait states				400	kHz
$t_{w(H)}$ Pulse duration, SCL high		0.6			μs
$t_{w(L)}$ Pulse duration, SCL low		1.3			μs
$t_{su(1)}$ Setup time, SDA to SCL		100			ns
$t_{h(1)}$ Hold time, SCL to SDA		10			ns
t_{BUF} Bus free time between stop and start condition		1.3			μs
$t_{su(2)}$ Setup time, SCL to start condition		0.6			μs
$t_{h(2)}$ Hold time, start condition to SCL		0.6			μs
$t_{su(3)}$ Setup time, SCL to stop condition		0.6			μs

6.7 Switching Characteristics

over operating free-air temperature range (unless otherwise noted)

PARAMETER	TEST CONDITIONS	MIN	TYP	MAX	UNIT
T_{start} Start-up time	Time from I ² C write until boost and amplifier are fully enabled		2		ms

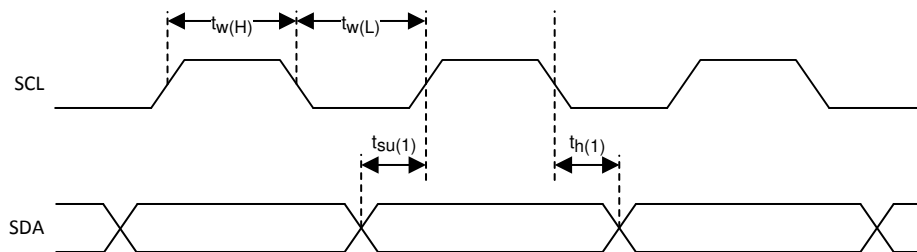

Figure 6-1. SCL and SDA Timing

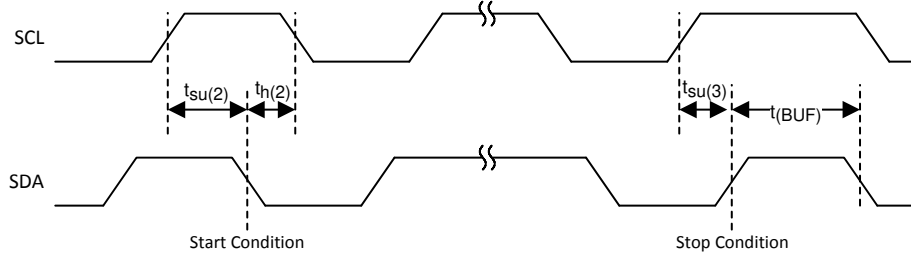
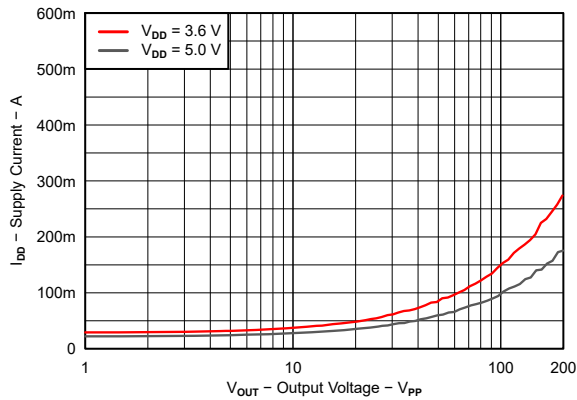

Figure 6-2. Timing for Start and Stop Conditions

6.8 Typical Characteristics



f = 200 Hz PVDD = 105 V
C_{LOAD} = 47 nF Gain = 40 dB

Figure 6-3. Supply Current vs Output Voltage

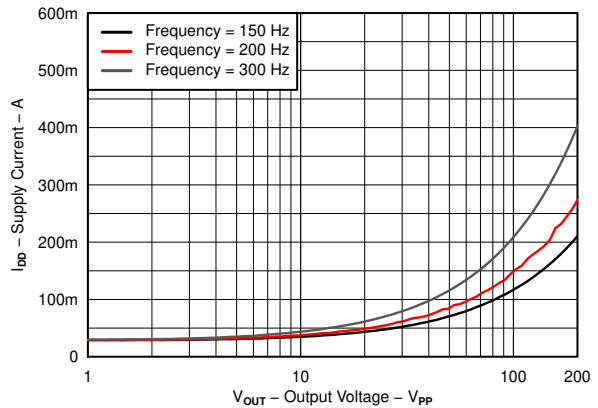

V_{DD} = 3.6 V PVDD = 105 V
C_{LOAD} = 47 nF Gain = 40 dB

Figure 6-4. Supply Current vs Output Voltage

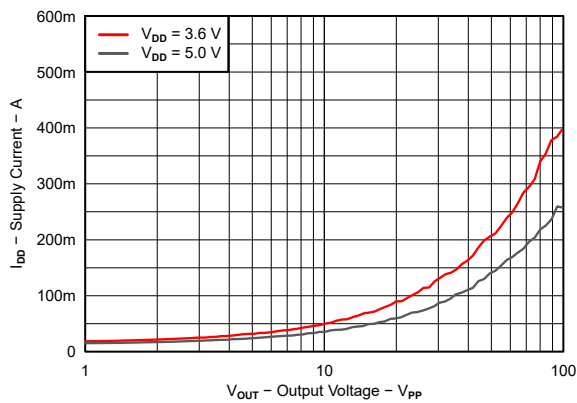

f = 200 Hz PVDD = 55 V
C_{LOAD} = 330 nF Gain = 34 dB

Figure 6-5. Supply Current vs Output Voltage

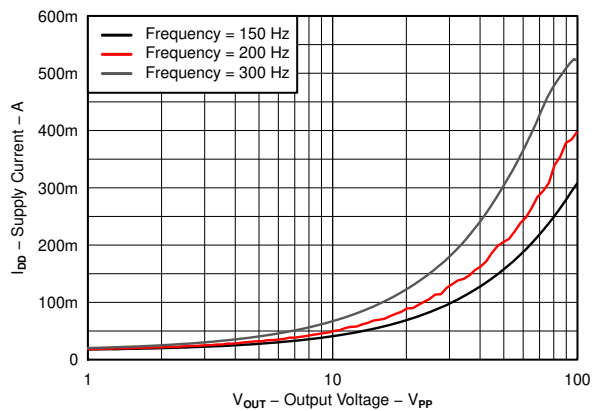

V_{DD} = 3.6 V PVDD = 55 V
C_{LOAD} = 330 nF Gain = 34 dB

Figure 6-6. Supply Current vs Output Voltage

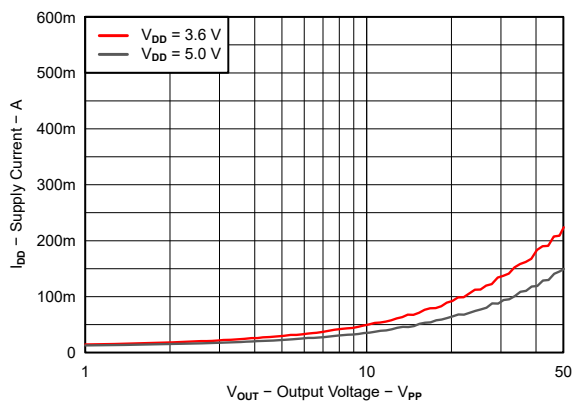

f = 200 Hz PVDD = 30 V
C_{LOAD} = 680 nF Gain = 28 dB

Figure 6-7. Supply Current vs Output Voltage

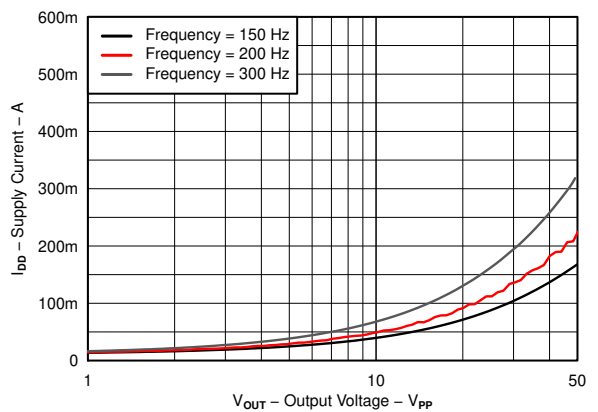

V_{DD} = 3.6 V PVDD = 30 V
C_{LOAD} = 680 nF Gain = 28 dB

Figure 6-8. Supply Current vs Output Voltage

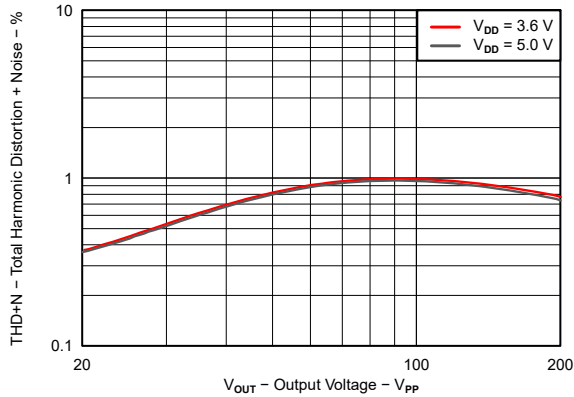

$f = 200 \text{ Hz}$ $PVDD = 105 \text{ V}$
 $C_{LOAD} = 47 \text{ nF}$ $\text{Gain} = 40 \text{ dB}$

Figure 6-9. Total Harmonic Distortion + Noise vs Output Voltage

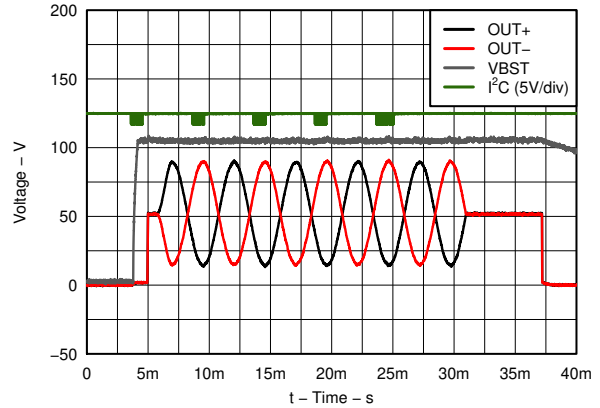

$V_{DD} = 3.6 \text{ V}$ $PVDD = 105 \text{ V}$
 $C_{LOAD} = 47 \text{ nF}$ $\text{Gain} = 40 \text{ dB}$

Figure 6-10. Typical Waveform

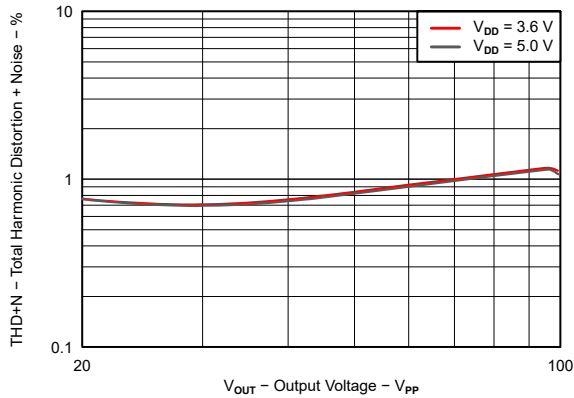

$f = 200 \text{ Hz}$ $PVDD = 55 \text{ V}$
 $C_{LOAD} = 330 \text{ nF}$ $\text{Gain} = 34 \text{ dB}$

Figure 6-11. Total Harmonic Distortion + Noise vs Output Voltage

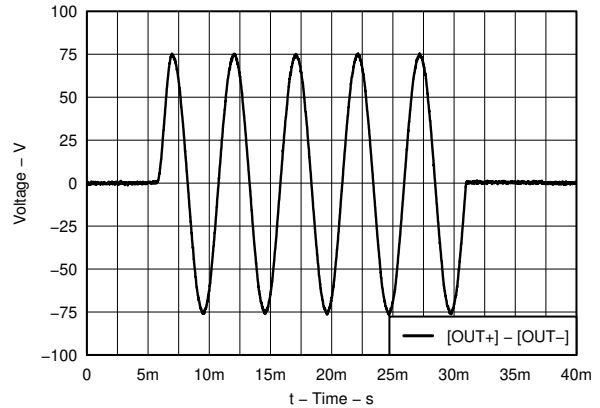

$V_{DD} = 3.6 \text{ V}$ $PVDD = 55 \text{ V}$
 $C_{LOAD} = 330 \text{ nF}$ $\text{Gain} = 34 \text{ dB}$

Figure 6-12. Typical Waveform – Differential

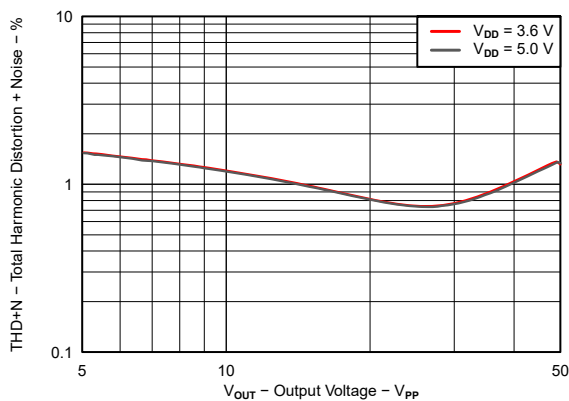

$f = 200 \text{ Hz}$ $PVDD = 30 \text{ V}$
 $C_{LOAD} = 680 \text{ nF}$ $\text{Gain} = 28 \text{ dB}$

Figure 6-13. Total Harmonic Distortion + Noise vs Output Voltage

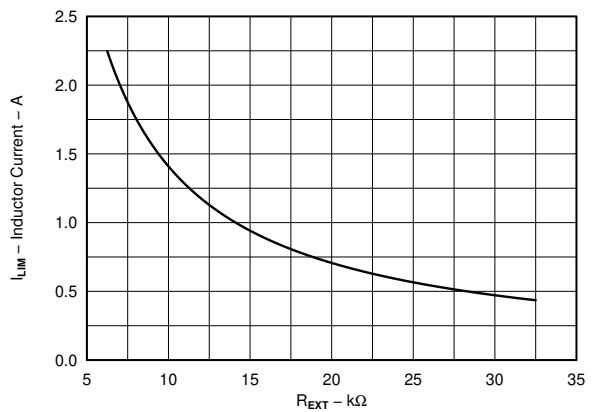

$V_{DD} = 3.6 \text{ V}$ $PVDD = 30 \text{ V}$
 $C_{LOAD} = 680 \text{ nF}$ $\text{Gain} = 28 \text{ dB}$

Figure 6-14. I_{LIM} vs $R_{(EXT)}$

7 Detailed Description

7.1 Overview

The DRV2665 device is a piezo haptic driver with integrated boost switch, integrated power diode, integrated fully-differential amplifier, and integrated digital front end. This versatile device is capable of driving both high-voltage and low-voltage piezo haptic actuators. The input signal can be driven over the I²C port or the analog inputs.

The digital interface of the DRV2665 device is available through an I²C compatible bus. A digital interface relieves the costly processor burden of PWM generation or additional analog channel requirements in the host system. Any writes to the internal FIFO automatically wakes up the device and begin playing the waveform after the 2 ms internal startup procedure. When the data flow stops or the FIFO under runs, the device automatically enters a pop-less shutdown procedure.

The boost voltage is set using two external resistors, and the boost current limit is programmable through the R_{EXT} resistor. A typical start-up time of 2 ms makes the DRV2665 an ideal piezo driver for fast haptic responses. Thermal overload protection prevents the device from being damaged when overdriven.

7.2 Functional Block Diagram

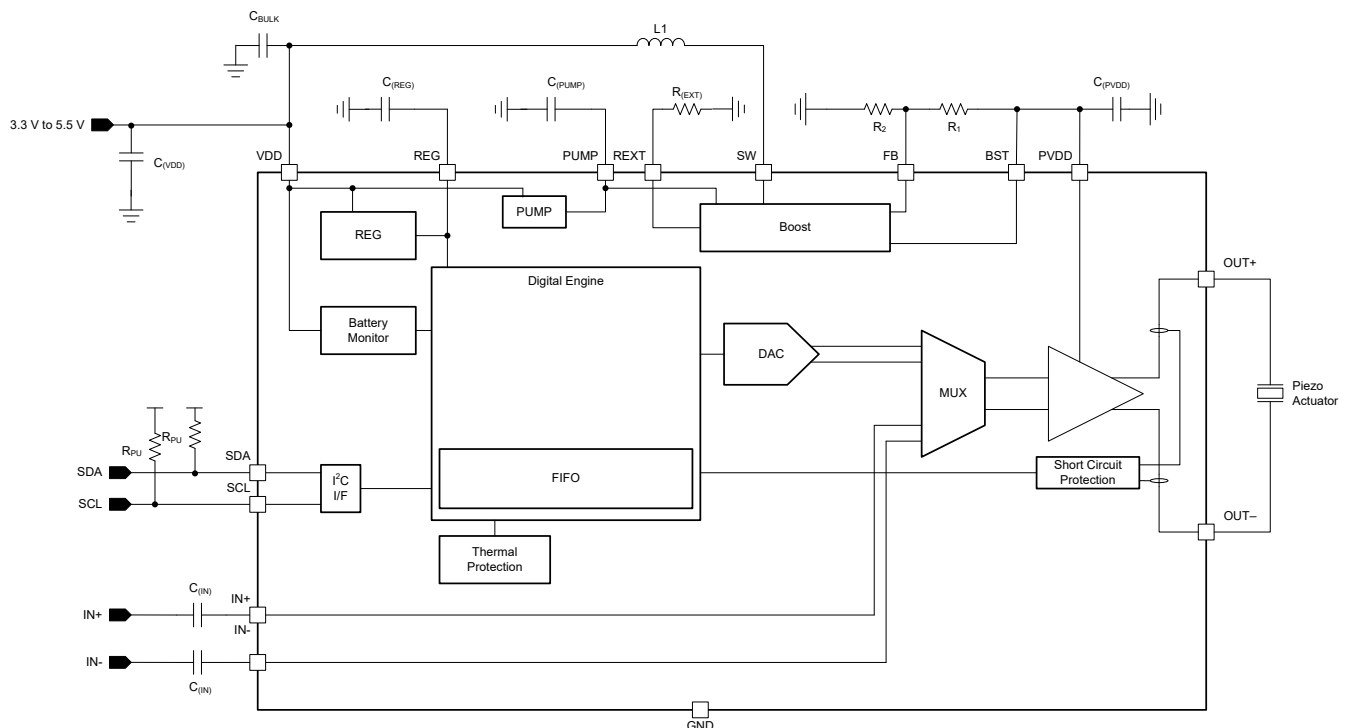

7.3 Feature Description

7.3.1 Support for Haptic Piezo Actuators

The DRV2665 device supports haptic piezo actuators of up to 200 V_{PP}.

7.3.2 Flexible Front End Interface

The DRV2665 device supports multiple approaches to launch and control haptic effects, that are detailed in [Section 7.4](#).

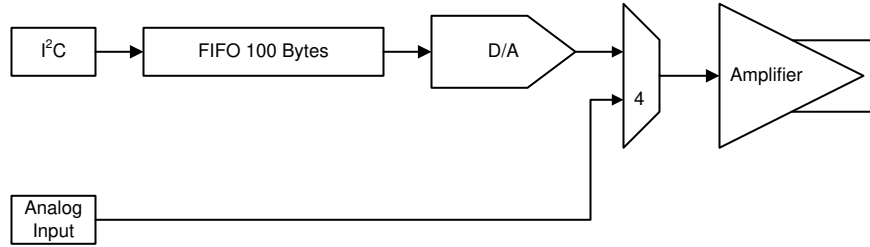

Figure 7-1. Front-End Interface

7.3.3 Ramp Down Behavior

If the user leaves the state of the DAC at any level other than mid-scale (0x00), the DAC automatically ramps down at a safe rate after the timeout period has expired. If the DRV2665 device is properly programmed, the ramp down sequence will never be used. This is a failsafe for any unavoidable interruptions to the playback process. Any writes to the FIFO during the ramp down period are discarded.

7.3.4 Low Latency Startup

The DRV2665 device features a fast startup time, that is essential for achieving low latency in haptic applications. When the STANDBY bit is transitioned from high to low, the device is ready for operation. The device logic automatically controls the internal boost converter and amplifier enable signals. The boost converter and amplifier are enabled only when needed and otherwise remain in a lower power idle state. When the device received a data byte through the FIFO interface, the boost converter and amplifier wake up and the internal logic sends the first sample through the internal DAC after the wake-up is completed. In the system application, the entire system latency must be kept to less than 30 ms total to be imperceptible to the end user. At a 2-ms wake-up time, the device is a small percentage of the total system latency.

If the EN_OVERRIDE bit is set, the device immediately enters the startup procedure and the boost converter and amplifier remain enabled, bypassing the internal controls. Subsequent transactions occur immediately with no wake-up overhead, but the boost converter and amplifier draw a quiescent current until the EN_OVERRIDE bit is cleared by the user.

7.3.5 Low Power Standby Mode

The DRV2665 device has a low-power standby mode through the I²C interface that puts the device in its lowest power state. This mode is entered when the standby bit (STANDBY) is set from low to high. When the STANDBY bit is set high, no other mode of operation is enabled. When the STANDBY bit transitions from high to low, the device is readied for operation and may receive data.

7.3.6 Device Reset

The DRV2665 device has software-based reset functionality. When the DEV_RST bit is set, the device immediately stops any transaction in process, resets all of its internal registers to the default values, and enters standby mode.

7.3.7 Amplifier Gain

The amplifier gain determines the gain from IN+/IN– to OUT+/OUT– when using the analog playback mode. For digital playback, the gain is optimized for achieving approximately 50 V_{PP}, 100 V_{PP}, 150 V_{PP}, 200 V_{PP} without clipping. Note that clipping of the amplifier occurs if the expected peak voltage is greater than the boost converter output voltage (VBST)

The DRV2665 device gain is programmable according to [Table 7-1](#).

Table 7-1. Amplifier Gain Table

GAIN[1]	GAIN[0]	FULL SCALE PEAK VOLTAGE (V)	GAIN (dB) ANALOG MODE
0	0	25	28.8
0	1	50	34.8

Table 7-1. Amplifier Gain Table (continued)

GAIN[1]	GAIN[0]	FULL SCALE PEAK VOLTAGE (V)	GAIN (dB) ANALOG MODE
1	0	75	38.4
1	1	100	40.7

7.3.8 Adjustable Boost Voltage

The output voltage of the integrated boost converter may be adjusted by a resistive feedback divider between the boost output voltage (VBST) and the feedback pin (FB). The boost voltage must be programmed to a value greater than the maximum peak signal voltage that the user expects to create with the device amplifier. Lower boost voltages achieve better system efficiency when lower amplitude signals are applied, thus the user must take care not to use a higher boost voltage than necessary. The maximum allowed boost voltage is 105 V.

7.3.9 Adjustable Current Limit

The current limit of the boost switch can be adjusted through a resistor to ground placed on the REXT pin. To avoid damage to both the inductor and the DRV2665 device, the programmed current limit must be less than the rated saturation limit of the inductor selected by the user. If the combination of the programmed limit and inductor saturation is not high enough, then the output current of the boost converter will not be high enough to regulate the boost output voltage under heavy load conditions. This then causes the boosted rail to sag, possibly causing distortion of the output waveform.

7.3.10 Internal Charge Pump

The DRV2665 device has an integrated charge pump to provide adequate gate drive for internal nodes. The output of this charge pump is placed on the PUMP pin. An X5R or X7R storage capacitor of 0.1 μ F with a voltage rating of 10 V or greater must be placed at this pin.

7.3.11 Device Protection

7.3.11.1 Thermal Protection

The DRV2665 device contains an internal temperature sensor that shuts down both the boost converter and the high-voltage amplifier when the temperature threshold is exceeded. When the device temperature falls below the threshold, the device will restart operation automatically. Continuous operation of the device is not recommended. Most haptic use models only operate the device in short bursts. The thermal shutdown function protects the device from damage when overdriven, but usage models which drive the device into thermal shutdown must always be avoided.

7.3.11.2 Overcurrent Protection

If the load demands more current than what the DRV2665 device can supply, the device automatically clamps the output voltage to avoid damage.

7.3.11.3 Brownout Protection

The DRV2665 device has on-chip brownout protection. When activated, a reset signal is issued that returns the DRV2665 device to the initial default state. If the voltage regulator V_{REG} goes below the brownout protection threshold (V_{BOT}) the DRV2665 device automatically shuts down. When V_{REG} returns to the typical output voltage (1.75 V), the DRV2665 device returns to the initial device state. The brownout protection threshold, V_{BOT} , is typically at 0.84 V.

There is one exception to this behavior. The brownout circuit is designed to tolerate fast brownout conditions as shown by Case 1 in [Figure 7-2](#). If the V_{DD} ramp-up rate is slower than 3.6 kV/s, then the device can fall into an unknown state. In such a situation, to return to the initial default state the device must be power-cycled with a V_{DD} ramp-up rate that is faster than 3.6 kV/s.

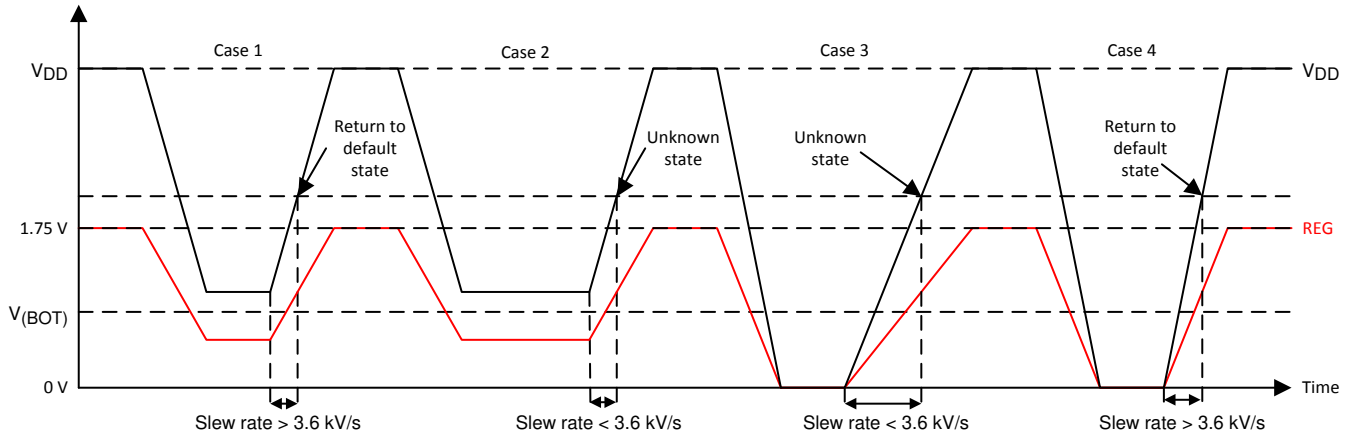

Figure 7-2. Brownout Behavior

7.4 Device Functional Modes

7.4.1 FIFO Mode

The DRV2665 device includes a 100-byte FIFO for real-time haptic waveform playback. The FIFO mode accepts 8-bit digital haptic waveform data over an I²C compatible bus and writes it into an on-chip FIFO. The data is read out of the FIFO automatically at an 8-kHz sampling rate and fed into a digital-to-analog converter (DAC). The DAC then drives the high-voltage amplifier. This mode is utilized when the user writes directly to the I²C FIFO entry address (0x0B). When the first data byte is written to the FIFO, the device goes through the proper start-up sequence and begins outputting the waveform automatically. An internal timing sequence waits approximately 2 ms before the first data is sent through the DAC and output by the device. It is important that the data values start and end at or near the mid-scale code (0x00) to avoid large steps at the beginning and end of the waveform. When the FIFO is empty, the device waits for the timeout period, and then enters into an idle state.

Because the speed of the serial interface could be faster than the read-out rate of the FIFO, the device does not acknowledge, or NAK, if the FIFO is full during a FIFO write transaction. If at any time the FIFO becomes completely full, the FIFO_FULL bit is set. When in this condition, the FIFO cannot accept more data without overwriting previous data that has not yet been played. If this occurs, the user must wait until data has had a chance to empty from the FIFO before sending more data. The data must be re-sent starting at the byte that received a NAK.

Any multi-byte I²C write to the FIFO register is treated as a continuous write to the FIFO. Multi-byte writes are preferred for optimum performance. The FIFO interprets the incoming data as twos complement. This means the maximum full-scale code is 0x7F, the maximum negative voltage is 0x80, and the mid-scale is 0x00.

7.4.2 Analog Playback Mode

In analog playback mode the signal in the IN+/IN- inputs is amplified and played through the high-voltage amplifier. When the INPUT_MUX bit is set, the DRV2665 device switches the analog inputs (IN+/IN-) to the high-voltage amplifier. While in the analog mode, the gain is still register-selectable. Also, the high-voltage amplifier enable is controlled directly through the EN_OVERRIDE bit, so the EN_OVERRIDE bit must be set for the boost and amplifier to be active.

7.4.3 Low Voltage Operation Mode

The lowest gain setting is optimized for 50 V_{PP} with a boost voltage of 30 V. Some applications may not need 50 V_{PP}, so the user may elect to program the boost converter as low as 15 V to improve efficiency. When using boost voltages lower than 30 V, consider the following: First, to reduce boost ripple to an acceptable level, a 50-V rated, 0.22-μF boost capacitor is recommended. Second, the maximum code range of the digital interface is limited. For example, the user may elect to program the boost voltage to 25 V, and plan for a maximum drive signal of 40 V_{PP} at the actuator. Any digital code given to the FIFO that is greater than $20 V_P / 25 V_P \times 127 = \pm 102$ may induce clipping, so the user must only send digital codes between -102 and 102. Use of codes outside this range, for this example, may clip or drive the actuator beyond its rating.

7.5 Programming

7.5.1 Programming the Boost Voltage

The boost output voltage is programmed through two external resistors as shown in [Figure 7-3](#). The boost output voltage is given by [Equation 1](#).

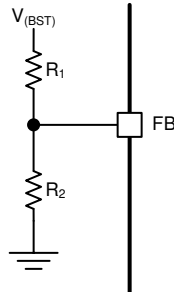

Figure 7-3. FB Network

$$V_{(BST)} = V_{(FB)} \cdot \left(1 + \frac{R_1}{R_2} \right) \quad (1)$$

where

- $V_{(FB)} = 1.32 \text{ V}$

$V_{(BST)}$ must be programmed to a value of 5.0 V greater than the largest peak voltage expected in the system to allow adequate amplifier headroom. Because the programming range for the boost voltage extends to 105 V, the leakage current through the resistor divider can become significant. It is recommended that the sum of the resistances $R_1 + R_2$ be greater than 400 k Ω . When resistor values greater than 1 M Ω are used, PCB contamination may cause boost voltage inaccuracy. Exercise caution when soldering large resistances, and clean the area when finished for best results. [Table 7-2](#) shows examples on how to configure the device for different output voltages.

Table 7-2. Boost Voltage Table

R_1	R_2	GAIN[1:0]	$V_{(BST)}$	FULL SCALE PEAK VOLTAGE (V)
402 k Ω	18.2 k Ω	00	30	25
392 k Ω	9.76 k Ω	01	55	50
768 k Ω	13 k Ω	10	80	75
768 k Ω	9.76 k Ω	11	105	100

7.5.2 Programming the Boost Current Limit

The peak current drawn from the supply through the inductor is set solely by the $R_{(EXT)}$ resistor. This peak current limit is independent of the inductance value chosen, but the inductor must be capable of handling this programmed limit. The relationship of $R_{(EXT)}$ and I_{LIM} is approximated by [Equation 2](#).

$$R_{(EXT)} = \left(K \cdot \frac{V_{REF}}{I_{LIM}} \right) - R_{INT} \quad (2)$$

where

- $K = 10500$, , and
- $V_{REF} = 1.35 \text{ V}$
- $R_{INT} = 60 \text{ }\Omega$
- I_{LIM} is the desired peak current limit through the inductor.

7.5.3 I²C Interface

7.5.3.1 General I²C Operation

The I²C bus employs two signals, SDA (data) and SCL (clock), to communicate between integrated circuits in a system. The bus transfers data serially, one bit at a time. The 8-bit address and data bytes are transferred with the most-significant bit (MSB) first. In addition, each byte transferred on the bus is acknowledged by the receiving device with an acknowledge bit. Each transfer operation begins with the master device driving a start condition on the bus and ends with the master device driving a stop condition on the bus. The bus uses transitions on the data pin (SDA) while the clock is at logic high to indicate start and stop conditions. A high-to-low transition on the SDA signal indicates a start, and a low-to-high transition indicates a stop. Normal data-bit transitions must occur within the low time of the clock period. Figure 7-4 shows a typical sequence. The master device generates the 7-bit slave address and the read-write (R/W) bit to start communication with a slave device. The master device then waits for an acknowledge condition. The slave device holds the SDA signal low during the acknowledge clock period to indicate acknowledgment. When this acknowledgment occurs, the master transmits the next byte of the sequence. Each device is addressed by a unique 7-bit slave address plus a R/W bit (1 byte). All compatible devices share the same signals through a bidirectional bus using a wired-AND connection.

The number of bytes that can be transmitted between start and stop conditions is not limited. When the last word transfers, the master generates a stop condition to release the bus. Figure 7-4 shows a generic data-transfer sequence.

Use external pullup resistors for the SDA and SCL signals to set the logic-high level for the bus. Pullup resistors with values between 660 Ω and 4.7 kΩ are recommended. Do not allow the SDA and SCL voltages to exceed the DRV2665 supply voltage, V_{DD}.

The DRV2665 device operates as an I²C-slave with 1.8-V logic thresholds, but can operate up to the V_{DD} voltage.

Note

The slave address for the DRV2665 device is 0x59 (7-bit), or 1011001 in binary, which is equivalent to 0xB2 (8-bit) for writing and 0xB3 (8-bit) for reading.

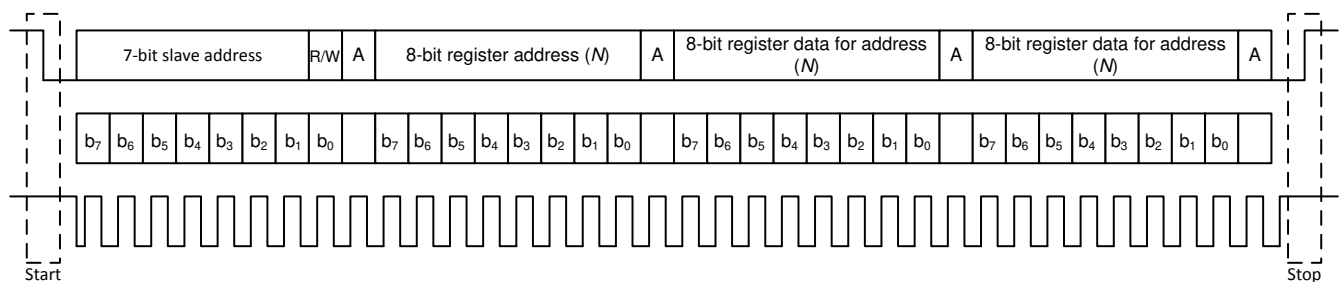

Figure 7-4. Typical I²C Sequence

7.5.3.2 Single-Byte and Multiple-Byte Transfers

The serial control interface supports both single-byte and multiple-byte read-write operations for all registers.

During multi-byte transactions, the register address provided serves as the starting address. Subsequent data transfers automatically increment the register address accessed until a stop condition is reached.

7.5.3.3 Single-Byte Write

As shown in Figure 7-5, a single-byte data-write transfer begins with the master device transmitting a start condition followed by the I²C device address and the read-write bit. The read-write bit determines the direction of the data transfer. For a write-data transfer, the read-write bit must be set to 0. After receiving the correct I²C device address and the read-write bit, the DRV2665 device responds with an acknowledge bit. Next, the master transmits the register byte corresponding to the DRV2665 internal-memory address that is accessed.

After receiving the register byte, the device responds again with an acknowledge bit. Finally, the master device transmits a stop condition to complete the single-byte data-write transfer.

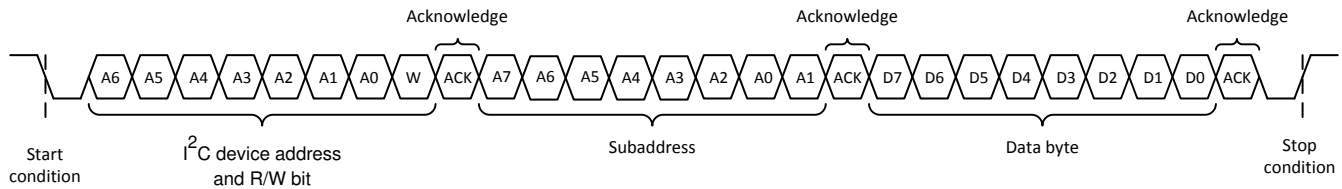

Figure 7-5. Single-Byte Write Transfer

7.5.3.4 Multiple-Byte Write and Incremental Multiple-Byte Write

A multiple-byte data write transfer is identical to a single-byte data write transfer except that multiple data bytes are transmitted by the master device to the DRV2665 device. After receiving each data byte, the DRV2665 device responds with an acknowledge bit as shown in [Figure 7-6](#).

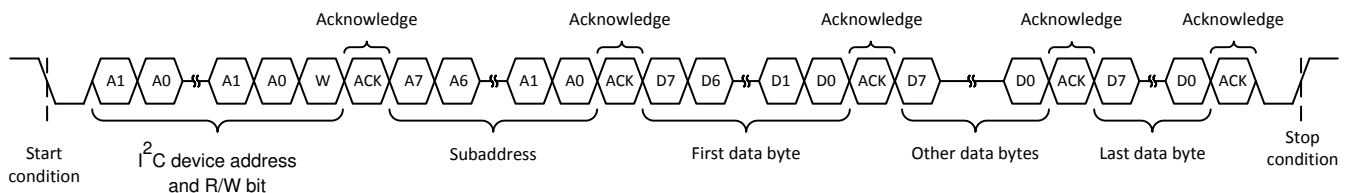

Figure 7-6. Multiple-Byte Write Transfer

7.5.3.5 Single-Byte Read

[Figure 7-7](#) shows that a single-byte data-read transfer begins with the master device transmitting a start condition followed by the I²C device address and the read-write bit. For the data-read transfer, both a write followed by a read actually occur. Initially, a write occurs to transfer the address byte of the internal memory address to be read. As a result, the read-write bit is set to 0.

After receiving the DRV2665 address and the read-write bit, the DRV2665 device responds with an acknowledge bit. The master then sends the internal memory address byte, after which the device issues an acknowledge bit. The master device transmits another start condition followed by the DRV2665 address and the read-write bit again. This time, the read-write bit is set to 1, indicating a read transfer. Next, the DRV2665 device transmits the data byte from the memory address that is read. After receiving the data byte, the master device transmits a not-acknowledge followed by a stop condition to complete the single-byte data read transfer. See the note in the [Section 7.5.3.1](#) section for the device address.

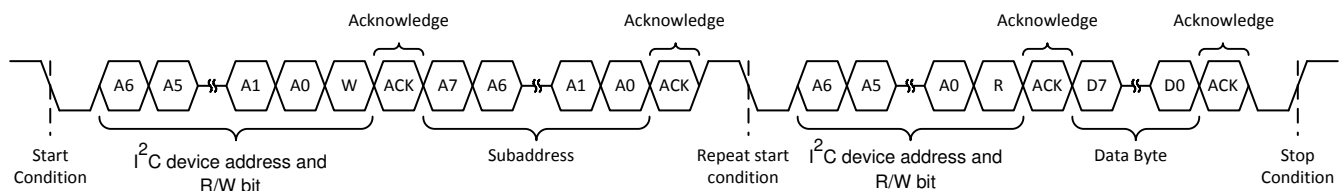

Figure 7-7. Single-Byte Read Transfer

7.5.3.6 Multiple-Byte Read

A multiple-byte data-read transfer is identical to a single-byte data-read transfer except that multiple data bytes are transmitted by the DRV2665 device to the master device as shown in Figure 7-8. With the exception of the last data byte, the master device responds with an acknowledge bit after receiving each data byte.

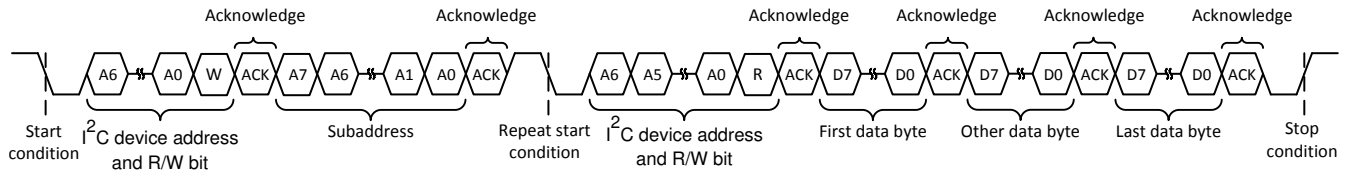

Figure 7-8. Multiple-Byte Read Transfer

7.6 Register Map

Table 7-3. Register Map Overview

REG NO.	DEFAULT	BIT 7	BIT 6	BIT 5	BIT 4	BIT 3	BIT 2	BIT 1	BIT 0
0x00	0x02	Reserved						FIFO_EMPTY	FIFO_FULL
0x01	0x28	Reserved	CHIPID[3:0]			INPUT_MUX		GAIN[1:0]	
0x02	0x40	DEV_RST	STANDBY	Reserved		TIMEOUT[1:0]		EN_OVERRIDE	Reserved
0x0B	0x00	FIFO[7:0]							

7.6.1 Address: 0x00

Figure 7-9. 0x00

7	6	5	4	3	2	1	0
Reserved						FIFO_EMPTY[0]	FIFO_FULL[0]
						RO-1	RO-0

Table 7-4. Address: 0x00

BIT	FIELD	TYPE	DEFAULT	DESCRIPTION
7-2	Reserved			
1	FIFO_EMPTY	RO	1	Indicates that the internal 100-byte FIFO is empty. 0 FIFO is not empty. 1 FIFO is empty.
0	FIFO_FULL	RO	0	Indicates that the internal 100-byte FIFO is full and cannot accept data until another byte has played through the internal DAC. 0 FIFO is not full. 1 FIFO is full.

7.6.2 Address: 0x01

Figure 7-10. 0x01

7	6	5	4	3	2	1	0
Reserved	CHIPID[3:0]			INPUT_MUX[0]	GAIN[1:0]		
	RO-0	RO-1	RO-0	RO-1	R/W-0	R/W-0	R/W-0

Table 7-5. Address: 0x01

BIT	FIELD	TYPE	DEFAULT	DESCRIPTION
7	Reserved			
6-3	CHIPID[3:0]	RO	5	Identifies the device. 0 DRV2660 7 DRV2667
2	INPUT_MUX	R/W	0	Selects the source to be played. 0 Digital input source 1 Analog input source
1-0	GAIN[1:0]	R/W	0	Selects the gain for the amplifier. 0 25 V (Digital) - 28.8 dB (Analog) 1 50 V (Digital) - 34.8 dB (Analog) 2 75 V (Digital) - 38.4 dB (Analog) 3 100 V (Digital) - 40.7 dB (Analog)

7.6.3 Address: 0x02

Figure 7-11. 0x02

7	6	5	4	3	2	1	0
DEV_RST[0]	STANDBY[0]	Reserved		TIMEOUT[1:0]		EN_OVERRIDE[0]	Reserved
R/W-0	R/W-1			R/W-0	R/W-0	R/W-0	

Table 7-6. Address: 0x02

BIT	FIELD	TYPE	DEFAULT	DESCRIPTION
7	DEV_RST	R/W	0	When asserted, the device will immediately stop any transaction in process, reset all of its internal register to their default values, and enters standby mode. 0 Normal operation 1 Reset device
6	STANDBY	R/W	1	Low-power standby 0 Device is active and ready to receive a signal. 1 Device is in low power standby mode.
5-4	Reserved			
3-2	TIMEOUT[1:0]	R/W	0	Time period when the FIFO runs empty and the device goes into idle mode, powering down the boost converter and amplifier. 0 5 ms 1 10 ms 2 15 ms 3 20 ms
1	EN_OVERRIDE	R/W	0	Override bit for the boost converter and amplifier enables. 0 Boost converter and amplifier enables are controlled by device logic. 1 Boost converter and amplifier are enabled indefinitely.
0--1	Reserved			

7.6.4 Address: 0x0B

Figure 7-12. 0x0B

7	6	5	4	3	2	1	0
FIFO[7:0]							
R/W-0	R/W-0	R/W-0	R/W-0	R/W-0	R/W-0	R/W-0	R/W-0

Table 7-7. Address: 0x0B

BIT	FIELD	TYPE	DEFAULT	DESCRIPTION
7-0	FIFO[7:0]	R/W	0	Entry point for FIFO data. The user repeatedly writes this register with continuous haptic waveform data.

8 Application and Implementation

Note

Information in the following applications sections is not part of the TI component specification, and TI does not warrant its accuracy or completeness. TI's customers are responsible for determining suitability of components for their purposes. Customers must validate and test their design implementation to confirm system functionality.

8.1 Application Information

The typical application for a haptic driver is in a touch-enabled system that already has an application processor that makes the decision on when to execute haptic effects.

The DRV2665 device is configured and can be used fully with I²C communication to stream or launch haptic effects. Additionally, the system designer may decide to use the analog input to stream the desired haptic effects.

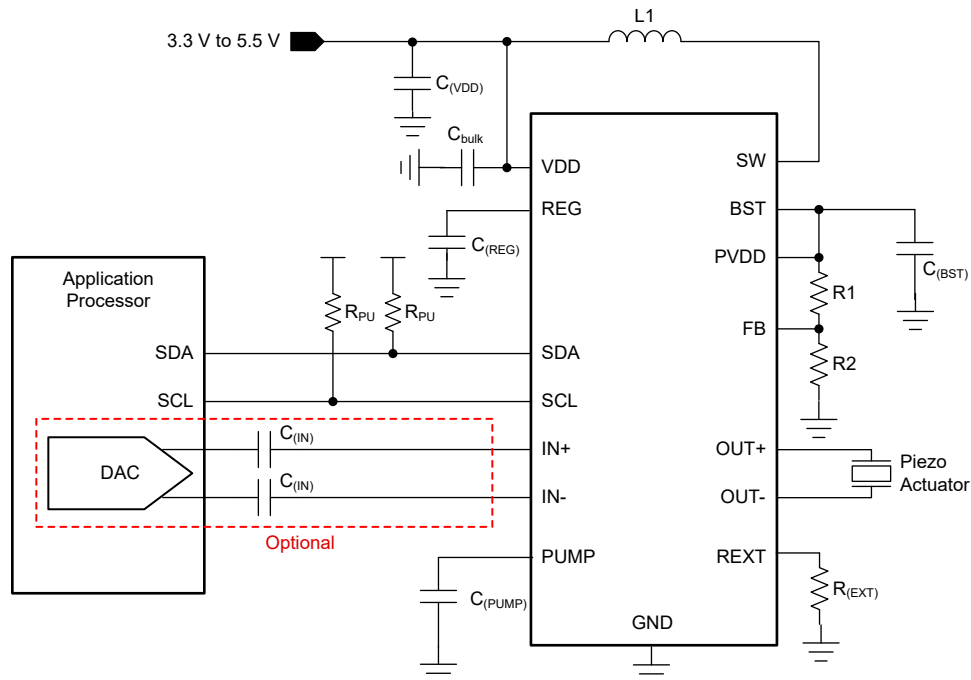

Figure 8-1. Typical Application Configuration

Table 8-1. Recommended External Components

COMPONENT	DESCRIPTION	SPECIFICATION	TYPICAL VALUE
$C_{(VDD)}$	Input capacitor	Capacitance	1 μ F
$C_{(REG)}$	Regulator capacitor	Capacitance	0.1 μ F
$C_{(BST)}$	Boost capacitor	Capacitance	0.1 μ F
C_{BULK}	Bulk capacitor	Capacitance	10 μ F
$C_{(PUMP)}$	Internal charge pump capacitor	Capacitance	0.1 μ F
$C_{(IN)}$	AC coupling capacitor (optional)	Capacitance	1 μ F
R_1	Boost feedback resistor (see Section 7.5.1)	Resistance	768 k Ω
R_2	Boost feedback resistor (see Section 7.5.1)	Resistance	9.76 k Ω
R_2	Current limit resistor (see Section 7.5.2)	Resistance	13 k Ω

Table 8-1. Recommended External Components (continued)

COMPONENT	DESCRIPTION	SPECIFICATION	TYPICAL VALUE
R _(PU)	Pullup resistor	Resistance	2.2 kΩ
L ₁	Boost inductor	Inductance	3.3 μH

8.2 Typical Application

A typical application of the DRV2665 device is in a system that has external buttons which fire different haptic effects when pressed. [Figure 8-2](#) shows a typical schematic of such a system. The buttons can be physical buttons, capacitive-touch buttons, or GPIO signals coming from the touch-screen system.

Effects in this type of system are programmable.

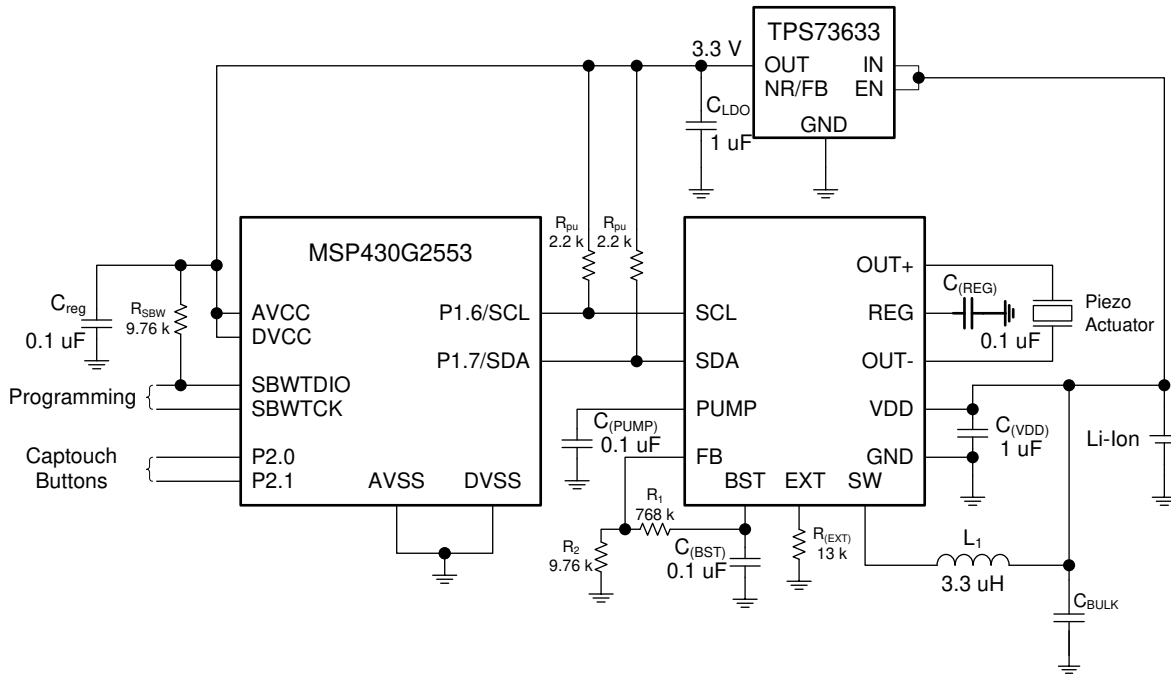

Figure 8-2. Example Application Schematic

8.2.1 Design Requirements

For this design example, use the values listed in [Table 8-2](#) as the input parameters.

Table 8-2. Design Parameters

DESIGN PARAMETER	EXAMPLE VALUE
Actuator type	120 V _{PP}
Input power source	Li-ion / Li-polymer

8.2.2 Detailed Design Procedure

8.2.2.1 Inductor Selection

Inductor selection plays a critical role in the performance of the DRV2665 device. The range of recommended inductances is from 3.3 μF to 22 μF. In general, higher inductances within an inductor series of a given manufacturer have lower saturation current limits, and vice-versa. When a larger inductance is chosen, the device boost converter automatically runs at a lower switching frequency and incurs less switching losses; however, larger values of inductance may have higher equivalent series resistance (ESR), that increases the parasitic inductor losses. Because lower values of inductance generally have higher saturation currents, they are a better choice when attempting to maximize the output current of the boost converter. Ensure that the saturation current of the inductor selected is higher than the programmed current limit for the device.

8.2.2.2 Piezo Actuator Selection

There are several key specifications to consider when choosing a piezo actuator for haptics, such as dimensions, blocking force, and displacement. However, the key electrical specifications from the driver perspective are voltage rating and capacitance.

At the maximum frequency of 500 Hz, the device is optimized to drive up to 50 nF at 200 V_{PP}, that is the highest voltage swing capability. It drives larger capacitances if the programmed boost voltage is lowered and/or the user limits the input frequency range to lower frequencies (e.g. 300 Hz).

8.2.2.3 Boost Capacitor Selection

The boost output voltage may be programmed as high as 105 V. A capacitor with a voltage rating of at least the boost output voltage must be selected. A 250-V rated 100-nF capacitor of the X5R or X7R type is recommended for the 105 V case because ceramic capacitors tend to come in ratings of 100 V or 250 V. The selected boost capacitor must have a minimum working capacitance of at least 50 nF. For boost voltages from 30 V to 80 V, a 100-V rated or 250-V rated, 100-nF capacitor is acceptable. For boost voltages less than 30 V, a 50-V, 0.22-μF capacitor is recommended.

8.2.2.4 Bulk Capacitor Selection

The use of a bulk capacitor placed next to the inductor is recommended due to the switch pin current requirements. A ceramic capacitors of the X5R or X7R type with capacitance of at least 1 μF is recommended.

8.2.3 Application Curves

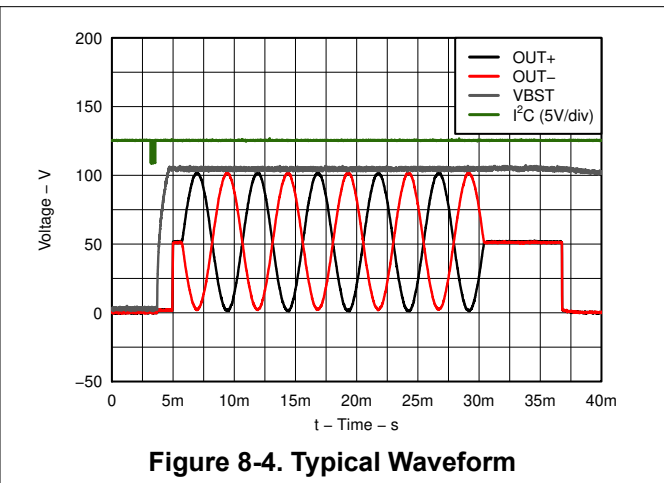
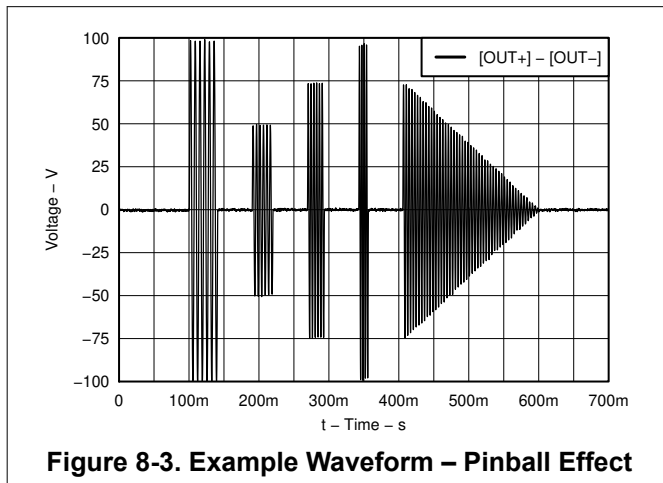

8.3 Initialization Setup

The DRV2665 device features a simple initialization procedure:

8.3.1 Initialization Procedure

1. Apply power to the DRV2665 device.
2. Wait for 1 ms for the DRV2665 device to power-up before attempting an I²C write.
3. Exit low-power standby mode by clearing the STANDBY bit in register 0x02, bit 6.
4. Choose the interface mode as analog or digital in register 0x01, bit 2.
5. Select the gain setting for your application in register 0x01, bits [1:0].
6. Choose the desired timeout period in register 0x02, bits[3:2].
7. If using the digital interface mode, the device is now ready to receive data. If using the analog input mode, set the EN_OVERRIDE bit in register 0x02, bit 1 to enable the boost and high-voltage amplifier and begin sourcing the waveform to the analog input.

9 Power Supply Recommendations

The DRV2665 device is designed to operate from an input-voltage supply range between 3.3 V and 5.5 V. The decoupling capacitor for the power supply must be placed as close to the device pin as possible.

10 Layout

10.1 Layout Guidelines

Use the following guidelines for the DRV2665 device layout:

- The decoupling capacitor for the power supply (V_{DD}) must be placed close to the device pin.
- The filtering capacitor for the regulator (REG) must be placed close to the device pin.
- The boost inductor must be placed as close as possible to the SW pin.
- The bulk capacitor for the boost must be placed as close as possible to the inductor.
- The charge pump capacitor (PUMP) must be placed close to the device pin.

Use of the thermal footprint outlined by this datasheet is recommended to achieve optimum device performance. See land pattern diagram for exact dimensions.

The DRV2665 device power pad must be soldered directly to the thermal pad on the printed circuit board. The printed circuit board thermal pad must be connected to the ground net and thermal vias to any existing backside/internal copper ground planes. Connection to a ground plane on the top layer near the corners of the device is also recommended. Another key layout consideration is to keep the boost programming resistors (R_1 and R_2) as close as possible to the FB pin of the device. Care must be taken to avoid getting the FB trace near the SW trace.

10.2 Layout Example

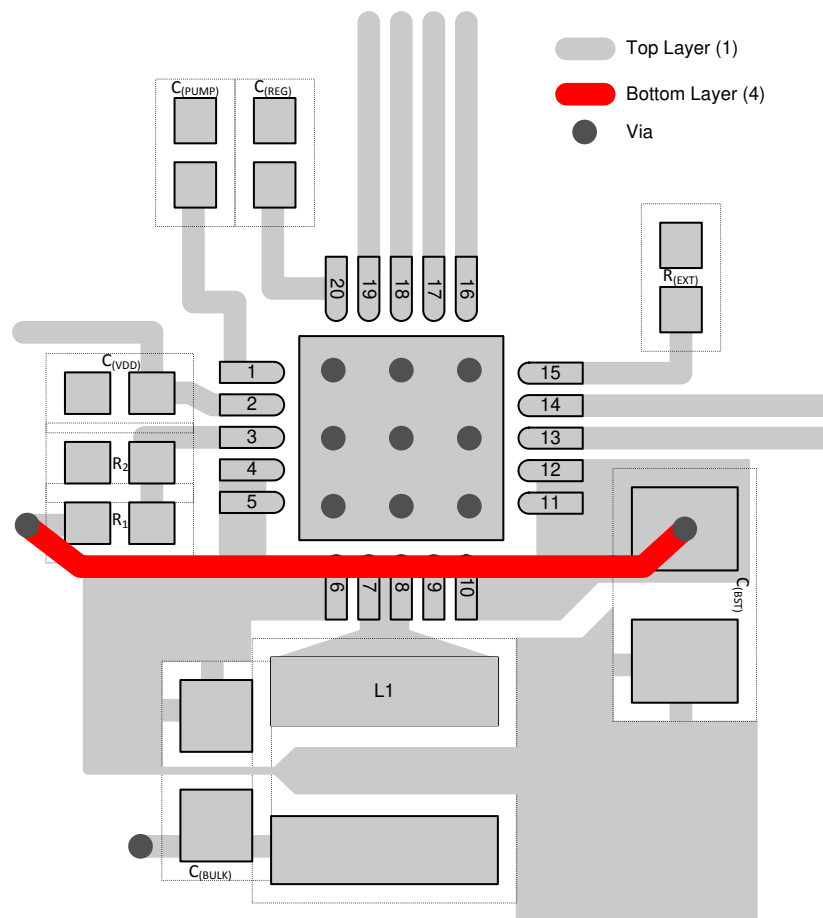

Figure 10-1. Layout Example with a 4-Layer Board

11 Device and Documentation Support

11.1 Community Resources

11.2 Trademarks

All trademarks are the property of their respective owners.

12 Mechanical, Packaging, and Orderable Information

The following pages include mechanical, packaging, and orderable information. This information is the most current data available for the designated devices. This data is subject to change without notice and revision of this document. For browser-based versions of this data sheet, refer to the left-hand navigation.

PACKAGING INFORMATION

Orderable Device	Status (1)	Package Type	Package Drawing	Pins	Package Qty	Eco Plan (2)	Lead finish/ Ball material (6)	MSL Peak Temp (3)	Op Temp (°C)	Device Marking (4/5)	Samples
DRV2665RGPR	ACTIVE	QFN	RGP	20	3000	RoHS & Green	NIPDAU	Level-4-260C-72 HR	-40 to 70	2665	Samples
DRV2665RGPT	ACTIVE	QFN	RGP	20	250	RoHS & Green	NIPDAU	Level-4-260C-72 HR	-40 to 70	2665	Samples

(1) The marketing status values are defined as follows:

ACTIVE: Product device recommended for new designs.

LIFEBUY: TI has announced that the device will be discontinued, and a lifetime-buy period is in effect.

NRND: Not recommended for new designs. Device is in production to support existing customers, but TI does not recommend using this part in a new design.

PREVIEW: Device has been announced but is not in production. Samples may or may not be available.

OBSOLETE: TI has discontinued the production of the device.

(2) **RoHS:** TI defines "RoHS" to mean semiconductor products that are compliant with the current EU RoHS requirements for all 10 RoHS substances, including the requirement that RoHS substance do not exceed 0.1% by weight in homogeneous materials. Where designed to be soldered at high temperatures, "RoHS" products are suitable for use in specified lead-free processes. TI may reference these types of products as "Pb-Free".

RoHS Exempt: TI defines "RoHS Exempt" to mean products that contain lead but are compliant with EU RoHS pursuant to a specific EU RoHS exemption.

Green: TI defines "Green" to mean the content of Chlorine (Cl) and Bromine (Br) based flame retardants meet JS709B low halogen requirements of <=1000ppm threshold. Antimony trioxide based flame retardants must also meet the <=1000ppm threshold requirement.

(3) MSL, Peak Temp. - The Moisture Sensitivity Level rating according to the JEDEC industry standard classifications, and peak solder temperature.

(4) There may be additional marking, which relates to the logo, the lot trace code information, or the environmental category on the device.

(5) Multiple Device Markings will be inside parentheses. Only one Device Marking contained in parentheses and separated by a "~" will appear on a device. If a line is indented then it is a continuation of the previous line and the two combined represent the entire Device Marking for that device.

(6) Lead finish/Ball material - Orderable Devices may have multiple material finish options. Finish options are separated by a vertical ruled line. Lead finish/Ball material values may wrap to two lines if the finish value exceeds the maximum column width.

Important Information and Disclaimer:The information provided on this page represents TI's knowledge and belief as of the date that it is provided. TI bases its knowledge and belief on information provided by third parties, and makes no representation or warranty as to the accuracy of such information. Efforts are underway to better integrate information from third parties. TI has taken and continues to take reasonable steps to provide representative and accurate information but may not have conducted destructive testing or chemical analysis on incoming materials and chemicals. TI and TI suppliers consider certain information to be proprietary, and thus CAS numbers and other limited information may not be available for release.

In no event shall TI's liability arising out of such information exceed the total purchase price of the TI part(s) at issue in this document sold by TI to Customer on an annual basis.

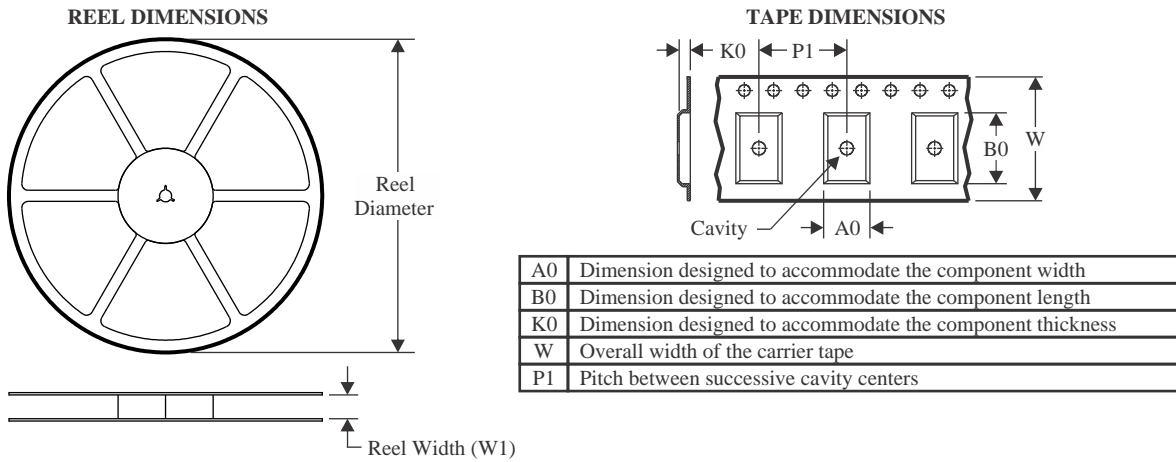
TAPE AND REEL INFORMATION

QUADRANT ASSIGNMENTS FOR PIN 1 ORIENTATION IN TAPE

*All dimensions are nominal

Device	Package Type	Package Drawing	Pins	SPQ	Reel Diameter (mm)	Reel Width W1 (mm)	A0 (mm)	B0 (mm)	K0 (mm)	P1 (mm)	W (mm)	Pin1 Quadrant
DRV2665RGPR	QFN	RGP	20	3000	330.0	12.4	4.25	4.25	1.15	8.0	12.0	Q2
DRV2665RGPT	QFN	RGP	20	250	180.0	12.4	4.25	4.25	1.15	8.0	12.0	Q2

TAPE AND REEL BOX DIMENSIONS

*All dimensions are nominal

Device	Package Type	Package Drawing	Pins	SPQ	Length (mm)	Width (mm)	Height (mm)
DRV2665RGPR	QFN	RGP	20	3000	346.0	346.0	33.0
DRV2665RGPT	QFN	RGP	20	250	210.0	185.0	35.0

GENERIC PACKAGE VIEW

RGP 20

VQFN - 1 mm max height

4 x 4, 0.5 mm pitch

VERY THIN QUAD FLATPACK

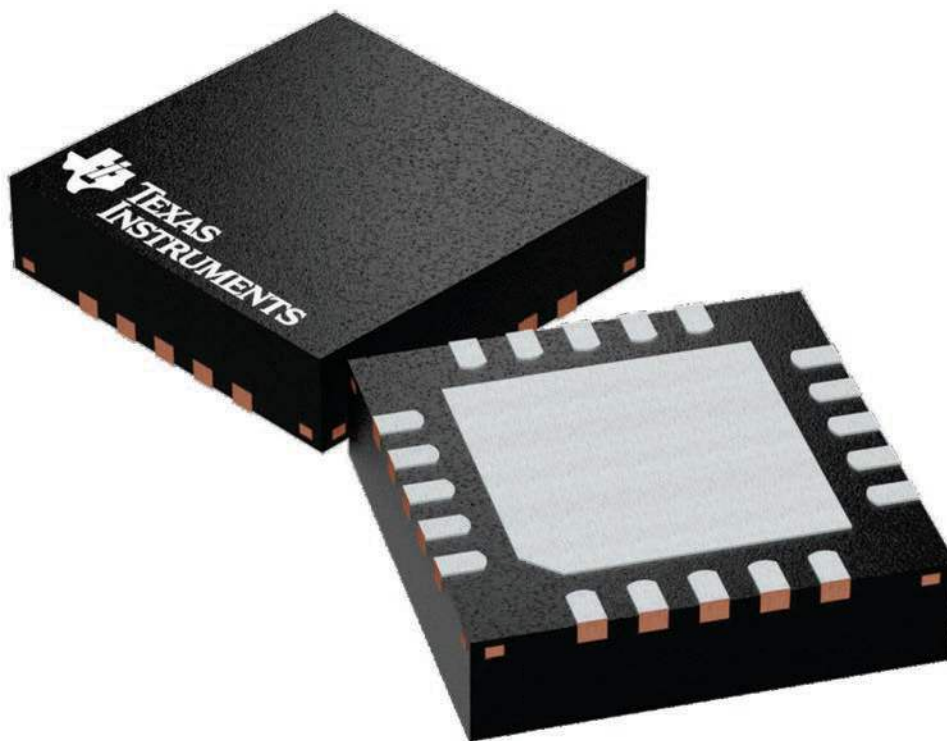

Images above are just a representation of the package family, actual package may vary.
Refer to the product data sheet for package details.

4224735/A

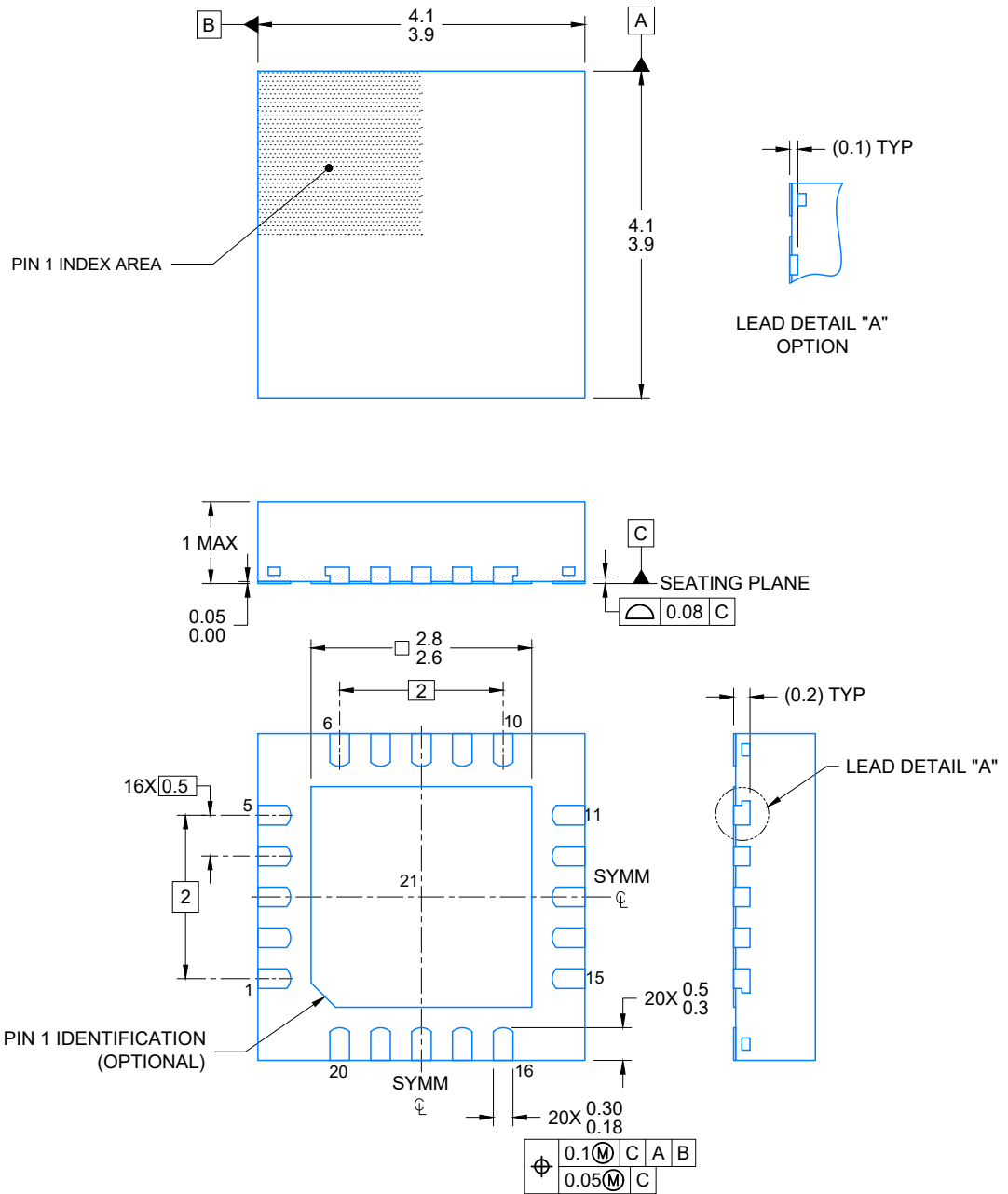

4219028/A 12/2018

NOTES:

1. All linear dimensions are in millimeters. Any dimensions in parenthesis are for reference only. Dimensioning and tolerancing per ASME Y14.5M.
2. This drawing is subject to change without notice.
3. The package thermal pad must be soldered to the printed circuit board for optimal thermal and mechanical performance.

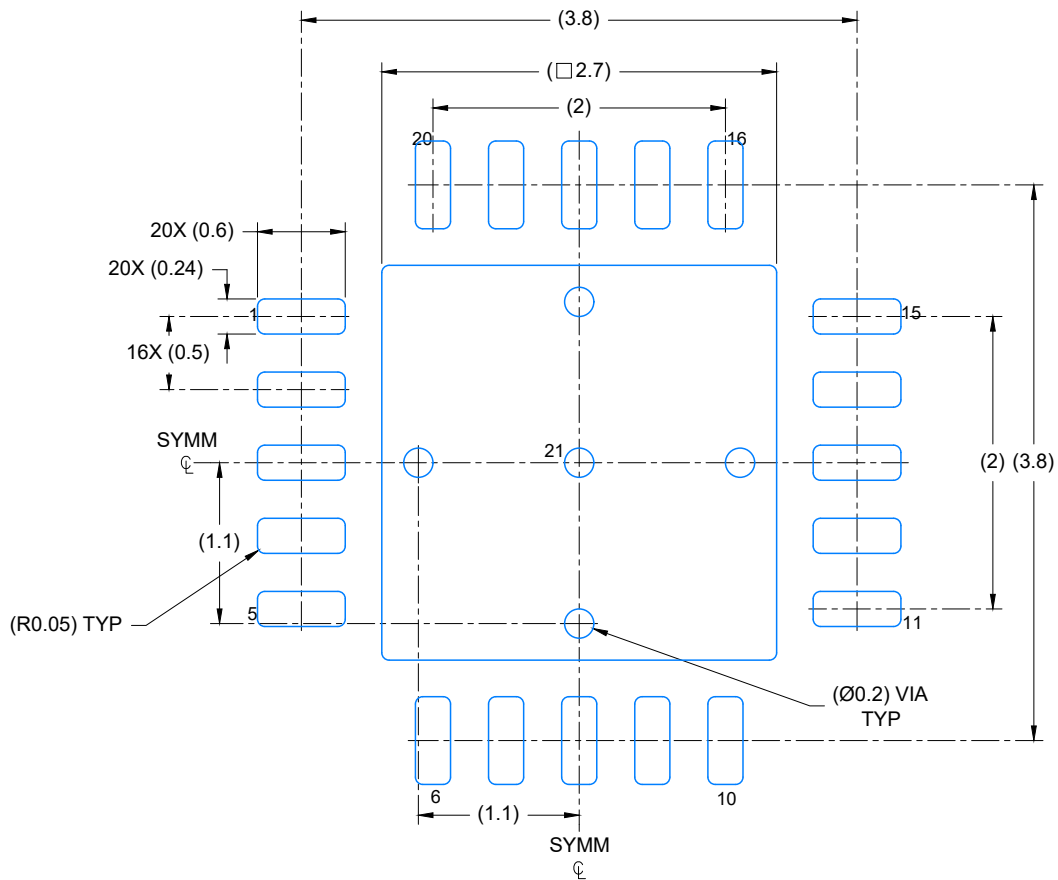

LAND PATTERN EXAMPLE
EXPOSED METAL SHOWN
SCALE: 20X

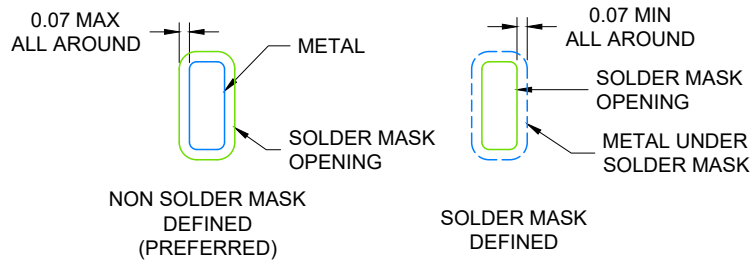

SOLDER MASK DETAILS

4219028/A 12/2018

NOTES: (continued)

4. This package is designed to be soldered to a thermal pad on the board. For more information, see Texas Instruments literature number SLUA271 (www.ti.com/lit/sluea271).
5. Vias are optional depending on application, refer to device data sheet. If any vias are implemented, refer to their locations shown on this view. It is recommended that vias under paste be filled, plugged or tented.

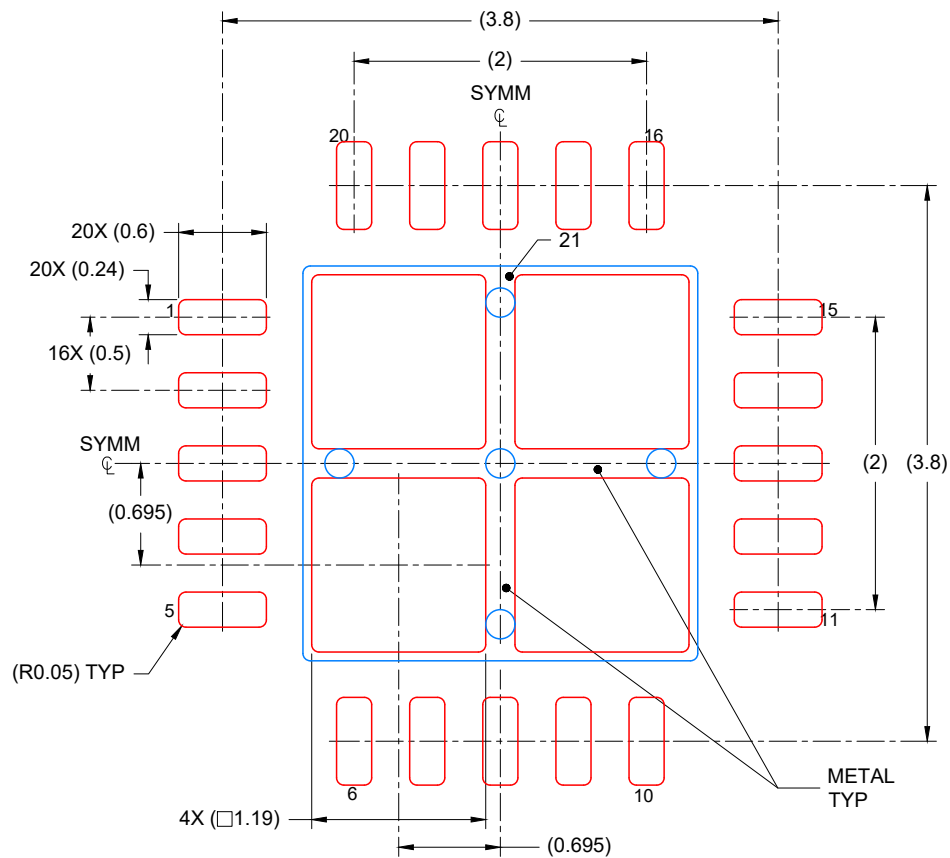

SOLDER PASTE EXAMPLE
 BASED ON 0.125 mm THICK STENCIL

EXPOSED PAD
 77% PRINTED COVERAGE BY AREA
 SCALE: 20X

4219028/A 12/2018

NOTES: (continued)

- 6. Laser cutting apertures with trapezoidal walls and rounded corners may offer better paste release. IPC-7525 may have alternate design recommendations.

IMPORTANT NOTICE AND DISCLAIMER

TI PROVIDES TECHNICAL AND RELIABILITY DATA (INCLUDING DATA SHEETS), DESIGN RESOURCES (INCLUDING REFERENCE DESIGNS), APPLICATION OR OTHER DESIGN ADVICE, WEB TOOLS, SAFETY INFORMATION, AND OTHER RESOURCES "AS IS" AND WITH ALL FAULTS, AND DISCLAIMS ALL WARRANTIES, EXPRESS AND IMPLIED, INCLUDING WITHOUT LIMITATION ANY IMPLIED WARRANTIES OF MERCHANTABILITY, FITNESS FOR A PARTICULAR PURPOSE OR NON-INFRINGEMENT OF THIRD PARTY INTELLECTUAL PROPERTY RIGHTS.

These resources are intended for skilled developers designing with TI products. You are solely responsible for (1) selecting the appropriate TI products for your application, (2) designing, validating and testing your application, and (3) ensuring your application meets applicable standards, and any other safety, security, regulatory or other requirements.

These resources are subject to change without notice. TI grants you permission to use these resources only for development of an application that uses the TI products described in the resource. Other reproduction and display of these resources is prohibited. No license is granted to any other TI intellectual property right or to any third party intellectual property right. TI disclaims responsibility for, and you will fully indemnify TI and its representatives against, any claims, damages, costs, losses, and liabilities arising out of your use of these resources.

TI's products are provided subject to [TI's Terms of Sale](#) or other applicable terms available either on [ti.com](https://www.ti.com) or provided in conjunction with such TI products. TI's provision of these resources does not expand or otherwise alter TI's applicable warranties or warranty disclaimers for TI products.

TI objects to and rejects any additional or different terms you may have proposed.

Mailing Address: Texas Instruments, Post Office Box 655303, Dallas, Texas 75265
Copyright © 2023, Texas Instruments Incorporated