



SURFACE MOUNT

Power Splitter/Combiner TCP-2-10+

50Ω 2 Way-0° 5 to 1000 MHz

FEATURES

- Low insertion, 0.5 dB typ.
- Excellent amplitude unbalance, 0.1 dB typ.
- Very good phase unbalance, 1.0 deg. typ.
- External resistor & capacitor required
- Aqueous washable
- Leads for excellent solderability
- Low cost



Generic photo used for illustration purposes only

CASE STYLE: DB714

+RoHS Compliant

The +Suffix identifies RoHS Compliance. See our web site for RoHS Compliance methodologies and qualifications

APPLICATIONS

- Cellular
- VHF/UHF
- Communications systems

ELECTRICAL SPECIFICATIONS AT 25°C

Parameter	Frequency (MHz)	Min.	Typ.	Max.	Unit
Frequency Range		5		1000	MHz
Insertion Loss, above 3.0 dB	5 - 50	—	0.3	0.9	dB
	50 - 500	—	0.5	0.9	
	500 - 1000	—	0.5	1.4	
Isolation	5 - 50	17	25	—	dB
	50 - 500	16	25	—	
	500 - 1000	16	21	—	
Phase Unbalance	5 - 50	—	—	4.0	Degree
	50 - 500	—	—	4.0	
	500 - 1000	—	—	6.0	
Amplitude Unbalance	5 - 50	—	—	0.6	dB
	50 - 500	—	—	0.6	
	500 - 1000	—	—	0.3	

MAXIMUM RATINGS

Parameter	Ratings
Operating temperature	-40°C to 85°C
Storage temperature	-55°C to 100°C
RF Power Input (as splitter)	0.5 W max.

Permanent damage may occur if any of these limits are exceeded.

FUNCTIONAL SCHEMATIC

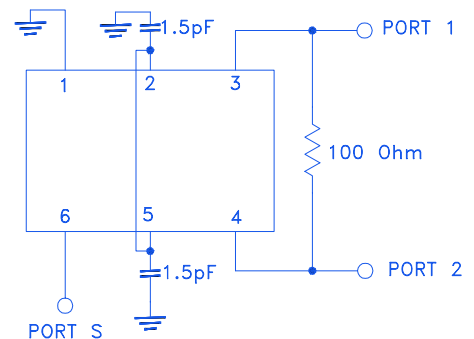

REV. K
ECO-012587
TCP-2-10+
AD/RS/CP/AM
220322





SURFACE MOUNT

Power Splitter/Combiner **TCP-2-10+**

PIN CONNECTIONS

SUM PORT	6
PORT 1	3
PORT 2	4
GROUND	1
CONNECT	2,5
EXT. RESISTOR 100Ω	3,4
EXT. CAPACITOR 1.5pF	2 OR 5 TO GND

PRODUCT MARKING: N/A

DEMO BOARD MCL P/N: TB-232
SUGGESTED PCB LAYOUT (PL-001)

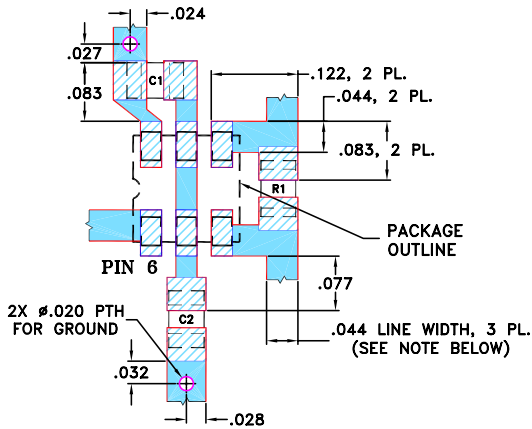

RESISTOR R1: 100 Ohm, 0805 SIZE
 CAPACITORS C1 & C2: 1.5 pF, 0805 SIZE

NOTES: 1. TRACE WIDTH IS SHOWN FOR ROGERS RO4350B WITH DIELECTRIC THICKNESS 0.020" ± 0.0015"; COPPER: 1/2 OZ. EACH SIDE. FOR OTHER MATERIALS TRACE WIDTH MAY NEED TO BE MODIFIED.

2. BOTTOM SIDE OF THE PCB IS CONTINUOUS GROUND PLANE.

- DENOTES PCB COPPER LAYOUT WITH SMOBC (SOLDER MASK OVER BARE COPPER)
- DENOTES COPPER LAND PATTERN FREE OF SOLDER MASK

OUTLINE DRAWING

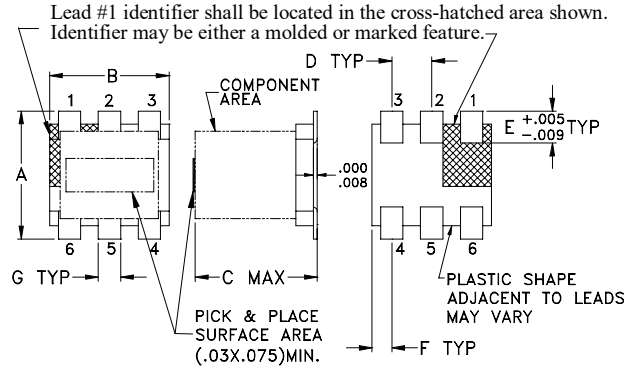

PCB Land Pattern

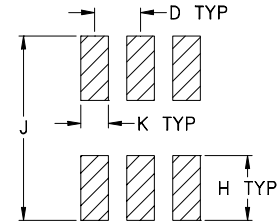

Suggested Layout,
 Tolerance to be within ±.002

OUTLINE DIMENSIONS (Inches mm)

A	B	C	D	E	F
.160	.150	.160	.050	.040	.025
4.06	3.81	4.06	1.27	1.02	0.64
G	H	J	K	wt	
.028	.065	.190	.030	grams	
0.71	1.65	4.83	0.76	0.15	

TAPE & REEL INFORMATION: F47



SURFACE MOUNT

Power Splitter/Combiner **TCP-2-10+**

Mini-Circuits

TYPICAL PERFORMANCE DATA AT 25°C

Frequency (MHz)	Total Loss ¹ (dB)		Amplitude Unbalance (dB)	Isolation (dB)	Phase Unbalance (deg.)	VSWR (:1)		
	S-1	S-2				S	1	2
5.00	3.10	3.24	0.14	32.43	0.15	1.02	1.11	1.14
6.00	3.10	3.24	0.14	32.64	0.15	1.02	1.11	1.14
8.00	3.10	3.24	0.14	32.81	0.09	1.02	1.10	1.14
10.00	3.11	3.24	0.13	32.85	0.09	1.02	1.10	1.14
25.00	3.12	3.25	0.14	32.38	0.01	1.02	1.10	1.14
40.00	3.13	3.27	0.14	31.84	0.06	1.02	1.10	1.14
60.00	3.13	3.28	0.14	31.23	0.09	1.03	1.10	1.13
90.00	3.15	3.29	0.14	30.38	0.10	1.03	1.10	1.13
120.00	3.16	3.30	0.14	29.54	0.11	1.04	1.09	1.13
200.00	3.19	3.33	0.14	27.50	0.24	1.05	1.09	1.11
400.00	3.27	3.40	0.13	23.84	0.45	1.07	1.06	1.06
600.00	3.37	3.48	0.11	21.78	0.71	1.09	1.05	1.02
800.00	3.49	3.58	0.09	20.95	0.98	1.09	1.08	1.09
900.00	3.55	3.63	0.08	21.06	1.15	1.09	1.12	1.14
1000.00	3.63	3.70	0.07	21.68	1.29	1.08	1.16	1.20

1. Total Loss = Insertion Loss + 3dB splitter loss.

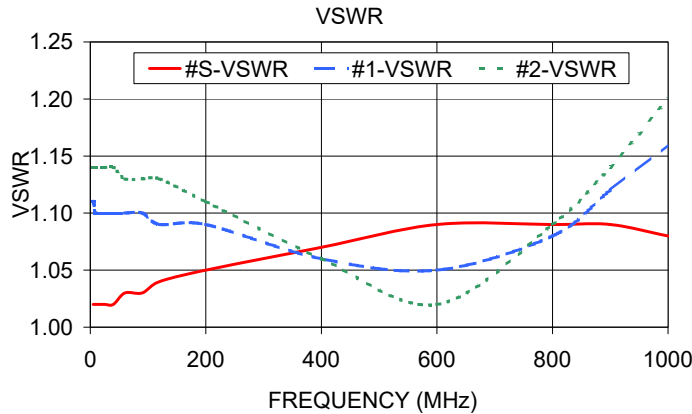
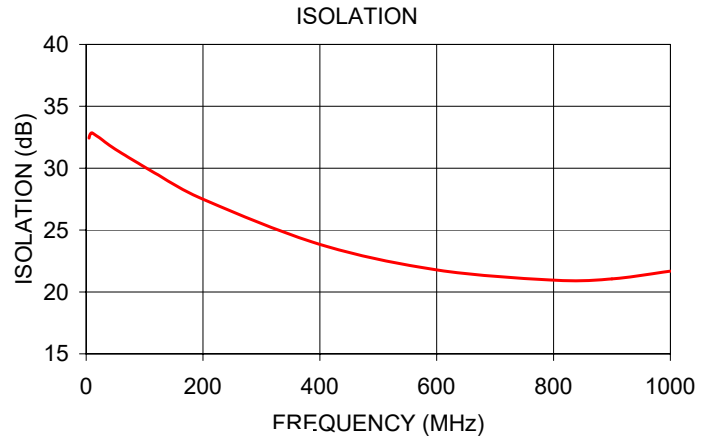
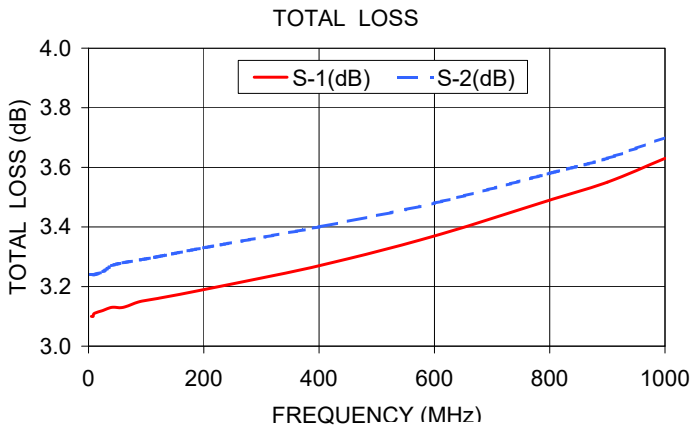

NOTES

- A. Performance and quality attributes and conditions not expressly stated in this specification document are intended to be excluded and do not form a part of this specification document.
- B. Electrical specifications and performance data contained in this specification document are based on Mini-Circuit's applicable established test performance criteria and measurement instructions.
- C. The parts covered by this specification document are subject to Mini-Circuits standard limited warranty and terms and conditions (collectively, "Standard Terms"); Purchasers of this part are entitled to the rights and benefits contained therein. For a full statement of the standard. Terms and the exclusive rights and remedies thereunder, please visit Mini-Circuits' website at www.minicircuits.com/terms/viewterm.html

