



24-Bit, 40kHz ANALOG-TO-DIGITAL CONVERTER

FEATURES

- 24 BITS—NO MISSING CODES
- 19 BITS EFFECTIVE RESOLUTION UP TO 40kHz DATA RATE
- LOW NOISE: 2.5ppm
- DIFFERENTIAL INPUTS
- INL: 0.0015% (max)
- EXTERNAL REFERENCE (0.5V to 5V)
- POWER-DOWN MODE
- SYNC MODE

APPLICATIONS

- CARDIAC DIAGNOSTICS
- DIRECT THERMOCOUPLE INTERFACES
- BLOOD ANALYSIS
- INFRARED PYROMETERS
- LIQUID/GAS CHROMATOGRAPHY
- PRECISION PROCESS CONTROL

DESCRIPTION

The ADS1252 is a precision, wide dynamic range, delta-sigma, Analog-to-Digital (A/D) converter with 24-bit resolution operating from a single +5V supply. The delta-sigma architecture is used for wide dynamic range and to ensure 24 bits of no missing code performance. An effective resolution of 19 bits (2.5ppm of rms noise) is achieved for conversion rates up to 40kHz.

The ADS1252 is designed for high-resolution measurement applications in cardiac diagnostics, smart transmitters, industrial process control, weight scales, chromatography, and portable instrumentation. The converter includes a flexible, 2-wire synchronous serial interface for low-cost isolation.

The ADS1252 is a single-channel converter and is offered in an SO-8 package.

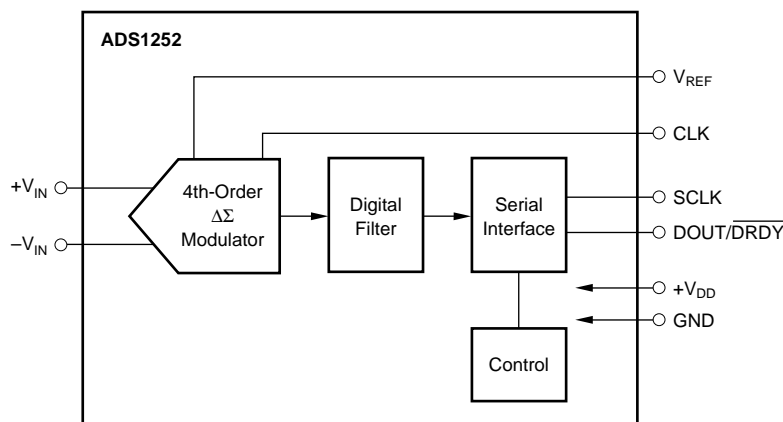

Please be aware that an important notice concerning availability, standard warranty, and use in critical applications of Texas Instruments semiconductor products and disclaimers thereto appears at the end of this data sheet.

All trademarks are the property of their respective owners.

ABSOLUTE MAXIMUM RATINGS⁽¹⁾

Analog Input: Current	±100mA, Momentary
	±10mA, Continuous
Voltage	GND – 0.3V to V _{DD} + 0.3V
V _{DD} to GND	–0.3V to 6V
V _{REF} Voltage to GND	–0.3V to V _{DD} + 0.3V
Digital Input Voltage to GND	–0.3V to V _{DD} + 0.3V
Digital Output Voltage to GND	–0.3V to V _{DD} + 0.3V
Lead Temperature (soldering, 10s)	+300°C
Power Dissipation (any package)	500mW

NOTE: (1) Stresses above these ratings may cause permanent damage. Exposure to absolute maximum conditions for extended periods may degrade device reliability.



ELECTROSTATIC DISCHARGE SENSITIVITY

This integrated circuit can be damaged by ESD. Texas Instruments recommends that all integrated circuits be handled with appropriate precautions. Failure to observe proper handling and installation procedures can cause damage.

ESD damage can range from subtle performance degradation to complete device failure. Precision integrated circuits may be more susceptible to damage because very small parametric changes could cause the device not to meet its published specifications.

PACKAGE/ORDERING INFORMATION⁽¹⁾

PRODUCT	PACKAGE-LEAD	PACKAGE DESIGNATOR	SPECIFIED TEMPERATURE RANGE	PACKAGE MARKING	ORDERING NUMBER	TRANSPORT MEDIA, QUANTITY
ADS1252	SO-8	D	–40°C to +85°C	ADS1252U	ADS1252U	Rails, 100
"	"	"	"	"	ADS1252U/2K5	Tape and Reel, 2500

NOTE: (1) For the most current package and ordering information, see the Package Option Addendum at the end of this document, or see the TI web site at www.ti.com.

PIN CONFIGURATION

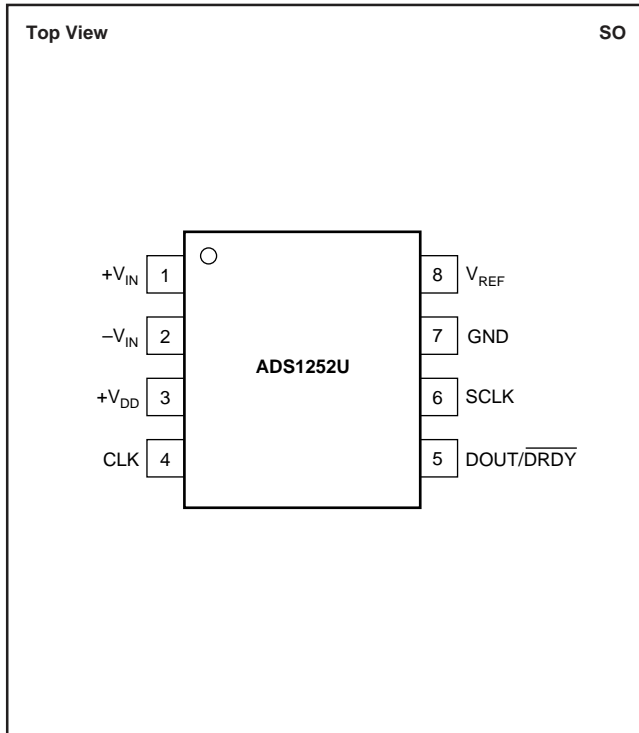

PIN DESCRIPTIONS

PIN	NAME	PIN DESCRIPTION
1	+V _{IN}	Analog Input: Positive Input of the Differential Analog Input
2	–V _{IN}	Analog Input: Negative Input of the Differential Analog Input
3	+V _{DD}	Input: Power-Supply Voltage, +5V
4	CLK	Digital Input: Device System Clock. The system clock is in the form of a CMOS-compatible clock. This is a Schmitt-Trigger input.
5	DOUT/ $\overline{\text{DRDY}}$	Digital Output: Serial Data Output/Data Ready. A logic LOW on this output indicates that a new output word is available from the ADS1252 data output register. The serial data is clocked out of the serial data output shift register using SCLK.
6	SCLK	Digital Input: Serial Clock. The serial clock is in the form of a CMOS-compatible clock. The serial clock operates independently from the system clock, therefore, it is possible to run SCLK at a higher frequency than CLK. The normal state of SCLK is LOW. Holding SCLK HIGH will either initiate a modulator reset for synchronizing multiple converters or enter power-down mode. This is a Schmitt-Trigger input.
7	GND	Input: Ground
8	V _{REF}	Analog Input: Reference Voltage Input

ELECTRICAL CHARACTERISTICS

All specifications at T_{MIN} to T_{MAX} , $V_{DD} = +5V$, $CLK = 16MHz$, and $V_{REF} = 4.096V$, unless otherwise specified.

PARAMETER	CONDITIONS	ADS1252U			UNITS
		MIN	TYP	MAX	
ANALOG INPUT					
Full-Scale Input Voltage		0	$\pm V_{REF}$		V
Absolute Input Voltage	$+V_{IN}$ or $-V_{IN}$ to GND	-0.3		V_{DD}	V
Differential Input Impedance	CLK = 3.84kHz		125		$M\Omega$
	CLK = 1MHz		480		k Ω
	CLK = 16MHz		30		k Ω
Input Capacitance			20		pF
Input Leakage	At +25°C		5	50	pA
	At T_{MIN} to T_{MAX}			1	nA
DYNAMIC CHARACTERISTICS					
Data Rate				41.7	kHz
Bandwidth	-3dB	9			kHz
Serial Clock (SCLK)				16	MHz
System Clock Input (CLK)				16	MHz
ACCURACY					
Integral Nonlinearity ⁽¹⁾			± 0.0003	± 0.0015	% of FSR
THD	1kHz Input; 0.1dB below FS		97		dB
Noise			2.5	3.8	ppm of FSR, rms
Resolution		24			Bits
No Missing Codes		24			Bits
Common-Mode Rejection ⁽²⁾	at DC	90	100		dB
Gain Error			0.4	1	% of FSR
Offset Error			± 100	± 200	ppm of FSR
Gain Sensitivity to V_{REF}	$V_{REF} = 4.096V \pm 0.1V$		1:1		
Power-Supply Rejection Ratio		60	80		dB
PERFORMANCE OVER TEMPERATURE					
Offset Drift			0.07		ppm/°C
Gain Drift	CLK = 16MHz		7.5		ppm/°C
	CLK = 14MHz		5.2		ppm/°C
	CLK = 12MHz		3.9		ppm/°C
	CLK < 10MHz		3.4		ppm/°C
VOLTAGE REFERENCE					
V_{REF}		0.5	4.096	V_{DD}	V
Load Current			220		μA
DIGITAL INPUT/OUTPUT					
Logic Family			CMOS		
Logic Level: V_{IH}		+4.0		$+V_{DD} + 0.3$	V
V_{IL}		-0.3		+0.8	V
V_{OH}	$I_{OH} = -500\mu A$	+4.5			V
V_{OL}	$I_{OL} = 500\mu A$			0.4	V
Input (SCLK, CLK) Hysteresis			0.6		V
Data Format			Offset Binary Two's Complement		
POWER-SUPPLY REQUIREMENTS					
Operation	$V_{DD} = +5VDC$	+4.75	+5	+5.25	V
Quiescent Current			8	10	mA
Operating Power			40	50	mW
Power-Down Current			1	10	μA
TEMPERATURE RANGE					
Operating		-40		+85	°C
Storage		-60		+100	°C

NOTES: (1) Applies to full-differential signals.

(2) The common-mode rejection test is performed with a 100mV differential input.

TYPICAL CHARACTERISTICS

At $T_A = +25^\circ\text{C}$, $V_{DD} = +5\text{V}$, $\text{CLK} = 16\text{MHz}$, and $V_{REF} = 4.096\text{V}$, unless otherwise specified.

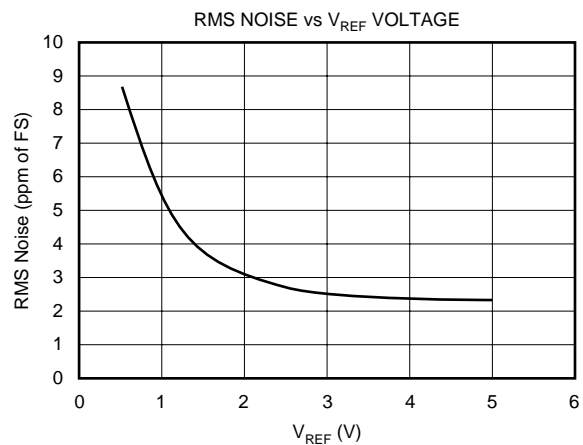
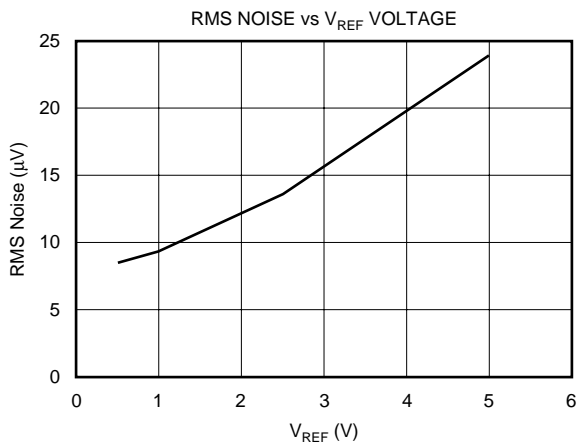
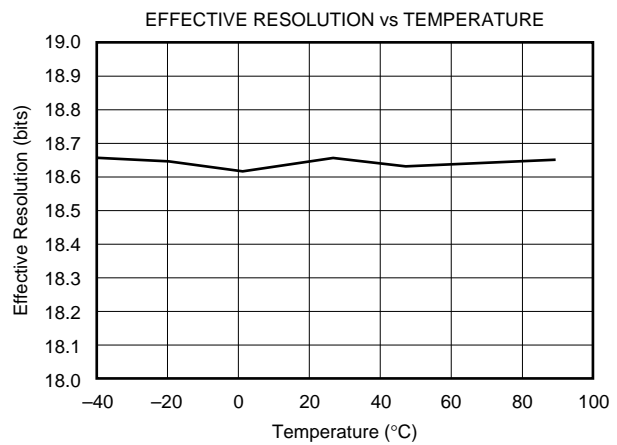
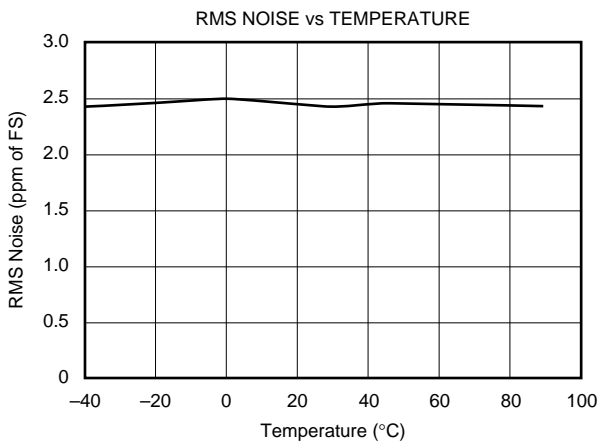
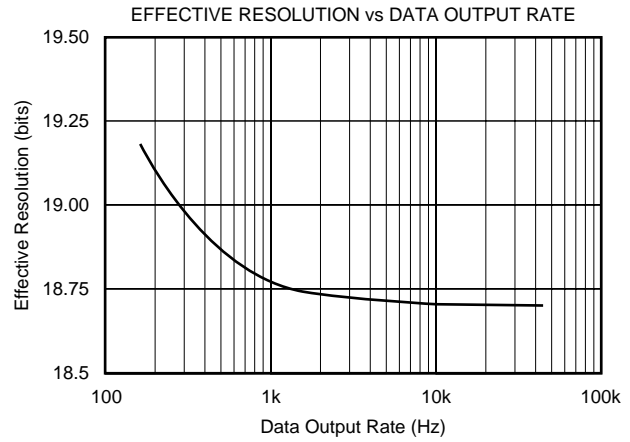
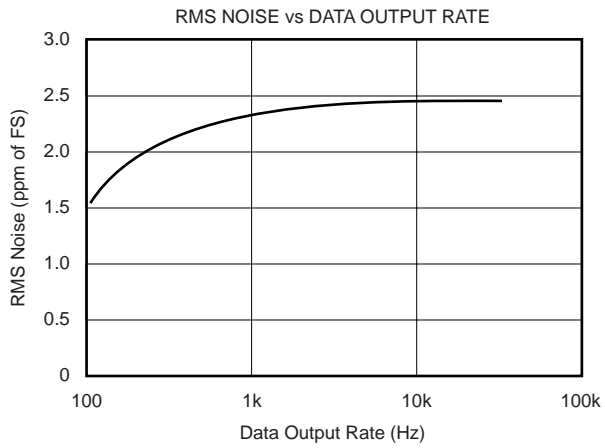

TYPICAL CHARACTERISTICS (Cont.)

At $T_A = +25^\circ\text{C}$, $V_{DD} = +5\text{V}$, $\text{CLK} = 16\text{MHz}$, and $V_{REF} = 4.096\text{V}$, unless otherwise specified.

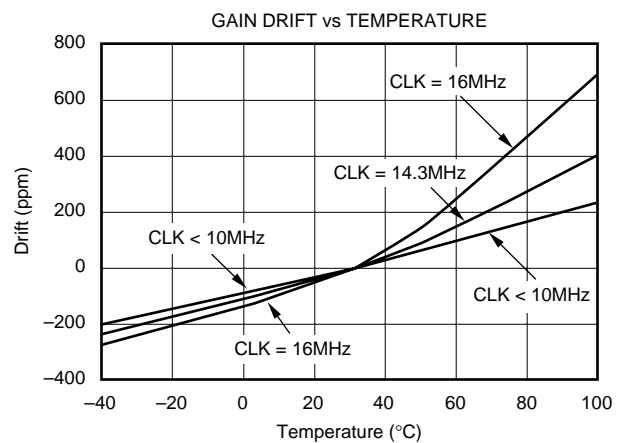
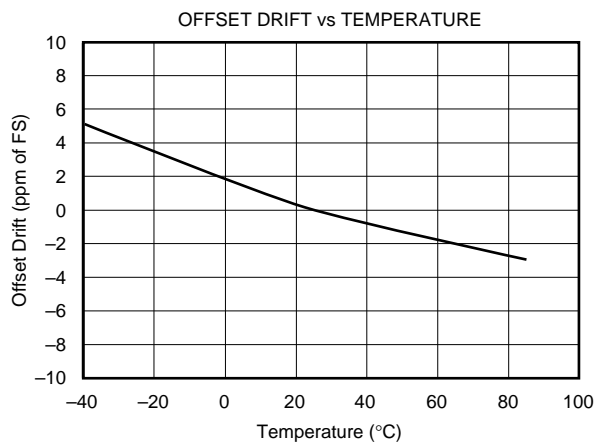
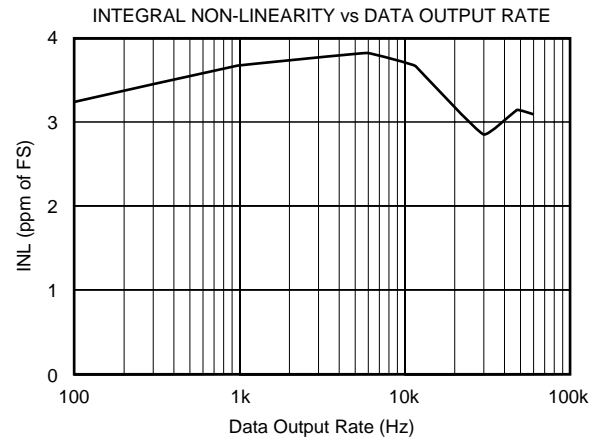
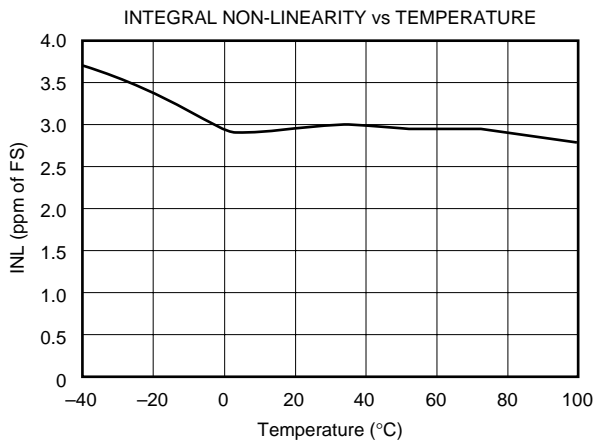
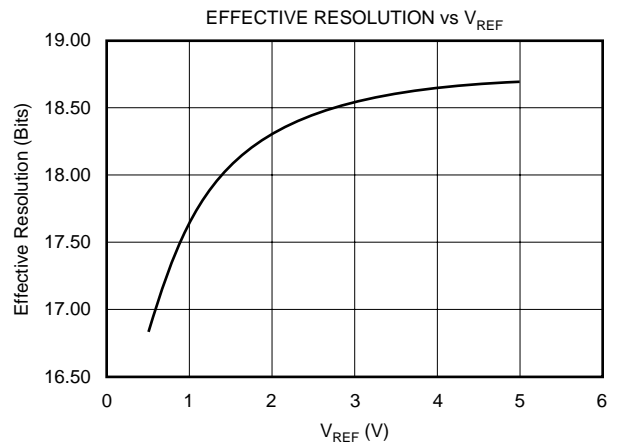
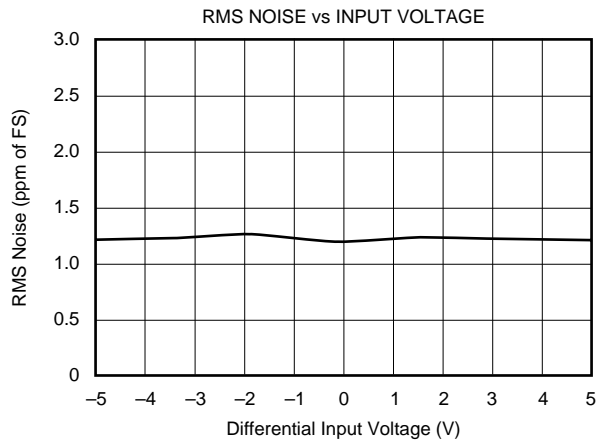

TYPICAL CHARACTERISTICS (Cont.)

At $T_A = +25^\circ\text{C}$, $V_{DD} = +5\text{V}$, $\text{CLK} = 16\text{MHz}$, and $V_{REF} = 4.096\text{V}$, unless otherwise specified.

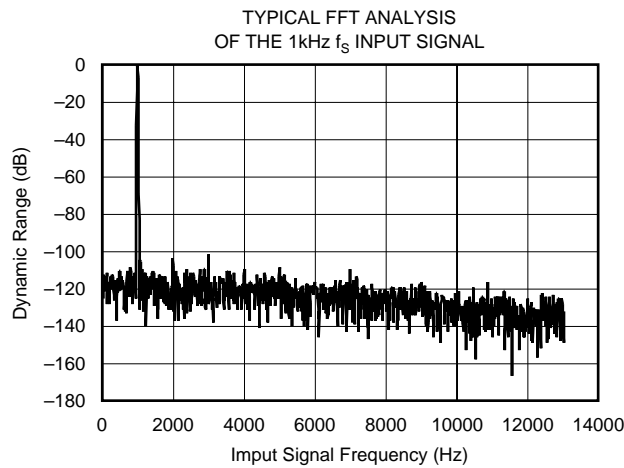
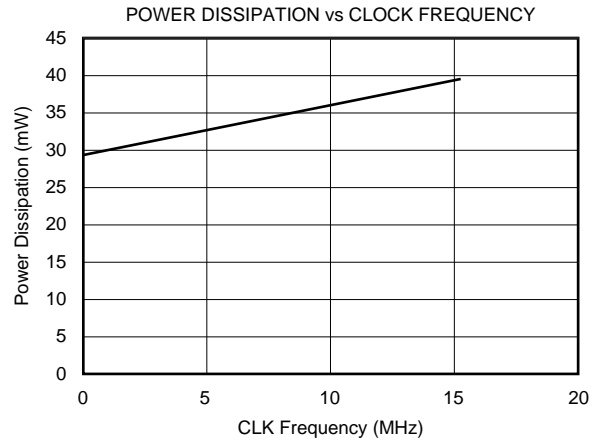
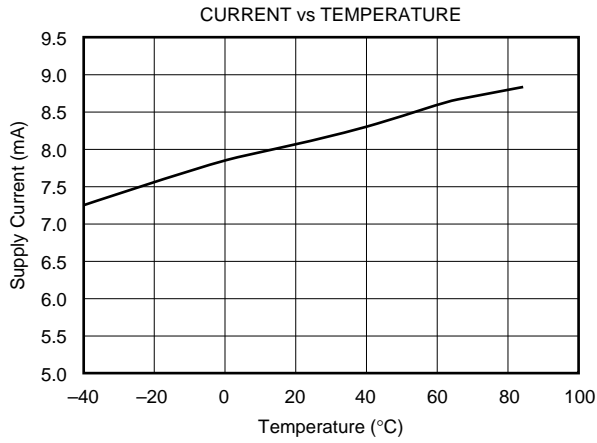
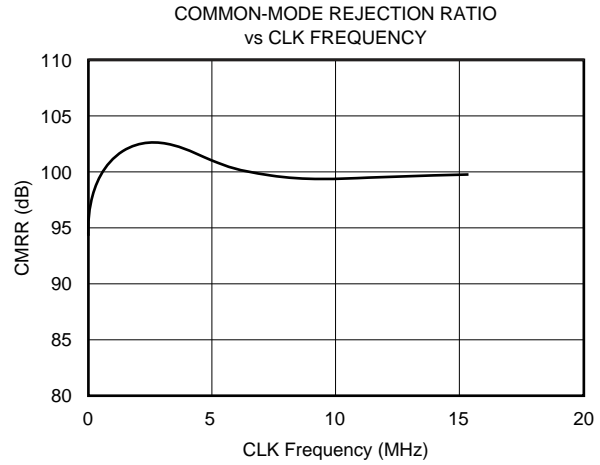
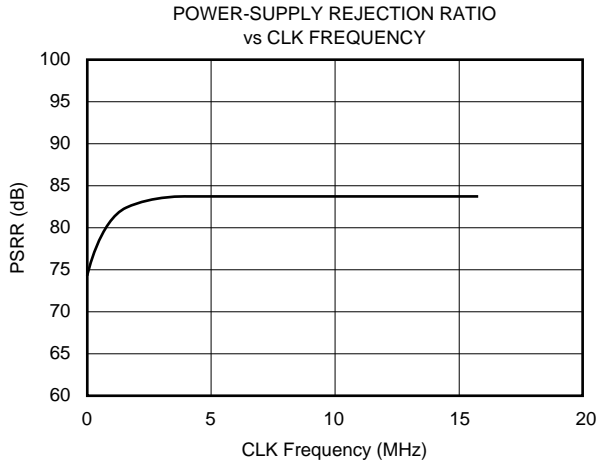

THEORY OF OPERATION

The ADS1252 is a precision, high-dynamic range, 24-bit, delta-sigma, A/D converter capable of achieving very high-resolution digital results at high data rates. The analog-input signal is sampled at a rate determined by the frequency of the system clock (CLK). The sampled analog input is modulated by the delta-sigma A/D modulator, which is followed by a digital filter. A Sinc⁵ digital low-pass filter processes the output of the delta-sigma modulator and writes the result into the data-output register. The DOUT/ $\overline{\text{DRDY}}$ pin is pulled LOW, indicating that new data is available to be read by the external microcontroller/microprocessor. As shown in the block diagram, the main functional blocks of the ADS1252 are the 4th-order delta-sigma modulator, a digital filter, control logic, and a serial interface. Each of these functional blocks is described below.

ANALOG INPUT

The ADS1252 contains a fully differential analog input. In order to provide low system noise, common-mode rejection of 100dB, and excellent power-supply rejection, the design topology is based on a fully differential switched-capacitor architecture. The bipolar input voltage range is from -4.096 to $+4.096\text{V}$, when the reference input voltage equals $+4.096\text{V}$; the bipolar range is with respect to $-V_{\text{IN}}$, and not with respect to GND.

With regard to the analog input signal, the overall analog performance of the device is affected by three items. First, the input impedance can affect accuracy; therefore, if the source impedance of the input signal is significant, or if there is passive filtering prior to the ADS1252, a significant portion of the signal can be lost across this external impedance. The magnitude of the effect is dependent on the desired system performance. See application note *Understanding the ADS1251, ADS1253, and ADS1254 Input Circuitry* (SBAA086), available for download from TI's web site, www.ti.com.

Second, the current into or out of the analog inputs must be limited. Under no conditions should the current into or out of the analog inputs exceed 10mA.

Third, to prevent aliasing of the input signal, the bandwidth of the analog input signal must be band limited; the bandwidth is a function of the system clock frequency. With a system clock frequency of 16MHz, the data-output rate is 41.667kHz with a -3dB frequency of 9kHz, where the -3dB frequency scales with the system clock frequency.

To ensure the best linearity of the ADS1252, a fully differential signal is recommended.

BIPOLAR INPUT

The differential inputs of the ADS1252 are designed to accept differential signals; however, each analog input voltage must stay between -0.3V and V_{DD} . With a reference voltage at less than half of V_{DD} , one input can be tied to the reference voltage, and the other input can range from 0V to $2 \cdot V_{\text{REF}}$. By using a single op amp circuit featuring a single amplifier and four external resistors, the ADS1252 can be configured to accept bipolar inputs referenced to ground. The conventional $\pm 2.5\text{V}$, $\pm 5\text{V}$, and $\pm 10\text{V}$ input ranges can be interfaced to the ADS1252 using the resistor values shown in Figure 1.

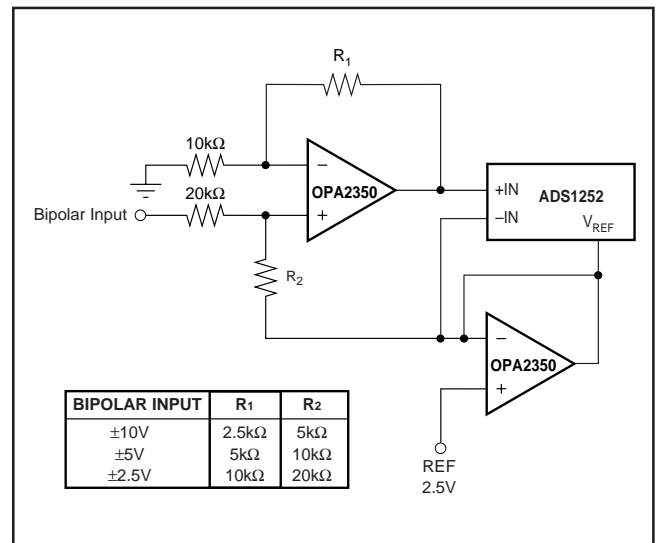

FIGURE 1. Level Shift Circuit for Bipolar Input Ranges.

DELTA-SIGMA MODULATOR

The ADS1252 operates from a nominal system clock frequency of 16MHz which is fixed in relation to the system clock frequency that is divided by 6 to derive the modulator frequency; therefore, with a system clock frequency of 16MHz, the modulator frequency is 2.667MHz. Furthermore, the oversampling ratio of the modulator is fixed in relation to the modulator frequency. The oversampling ratio of the modulator is 64, and with the modulator frequency running at 2.667MHz, the data rate is 41.667kHz; thus, using a slower system clock frequency will result in a lower data output rate, as shown in Table I.

CLK (MHz)	DATA OUTPUT RATE (Hz)
16.000 ⁽¹⁾	41 667
15.360 ⁽¹⁾	40 000
15.000 ⁽¹⁾	30 063
14.745600 ⁽¹⁾	38 400
14.318180 ⁽¹⁾	37 287
12.288000 ⁽¹⁾	32 000
12.000000 ⁽¹⁾	31 250
11.059220 ⁽¹⁾	28 800
10.000000 ⁽¹⁾	26 042
9.600000	25 000
7.372800 ⁽¹⁾	19 200
6.144000 ⁽¹⁾	16 000
6.000000 ⁽¹⁾	15 625
4.915200 ⁽¹⁾	12 800
3.686400 ⁽¹⁾	9 600
3.072000 ⁽¹⁾	8 000
2.457600 ⁽¹⁾	6 400
1.843200 ⁽¹⁾	4 800
0.921600	2 400
0.460800	1 200
0.384000	1 000
0.192000	500
0.038400	100
0.023040	60
0.019200	50
0.011520	30
0.009600	25
0.007680	20
0.006400	16.67
0.005760	15
0.004800	12.50
0.003840	10

NOTE: (1) Standard Clock Oscillator.

TABLE I. CLK Rate versus Data Output Rate.

REFERENCE INPUT

Reference input takes an average current of 220μA with a 16MHz system clock; this current will be proportional to the system clock. A buffered reference is recommended for ADS1252. The recommended reference circuit is shown in Figure 2.

Reference voltages higher than 4.096V will increase the full-scale range, whereas the absolute internal circuit noise of the converter remains the same. This will decrease the noise in terms of ppm of full scale, which increases the effective resolution (see the typical characteristic curve, *RMS Noise vs V_{REF}*).

DIGITAL FILTER

The digital filter of the ADS1252, referred to as a sinc⁵ filter, computes the digital result based on the most recent outputs from the delta-sigma modulator. At the most basic level, the digital filter can be thought of as simply averaging the modulator results in a weighted form and presenting this average as the digital output. The digital output rate, or data rate, scales directly with the system CLK frequency, this allows the data output rate to be changed over a very wide range (five orders of magnitude) by changing the system CLK frequency. However, it is important to note that the -3dB point of the filter is 0.216 times the data output rate, so the data output rate must allow for sufficient margin to prevent attenuation of the signal of interest.

As the conversion result is essentially an average, the data-output rate determines the location of the resulting notches in the digital filter (see Figure 3). Note that the first notch is located at the data-output rate frequency, and subsequent notches are located at integer multiples of the data-output rate to allow for rejection of not only the fundamental frequency, but also harmonic frequencies. In this manner, the data-output rate can be used to set specific notch frequencies in the digital filter response.

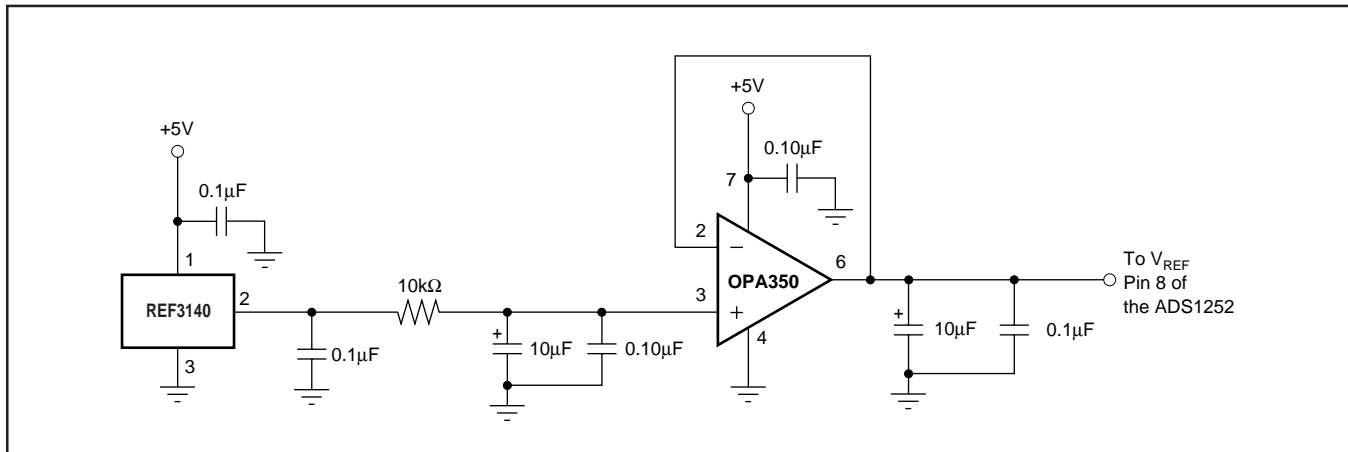

FIGURE 2. Recommended External Voltage Reference Circuit for Best Low-Noise Operation with the ADS1252.

For example, if the rejection of power-line frequencies is desired, then the data-output rate can simply be set to the power-line frequency. For 50Hz rejection, the system CLK frequency must be 19.200kHz, and this will set the data-output rate to 50Hz (see Table I and Figure 4). For 60Hz rejection, the system CLK frequency must be 20.040kHz, and this will set the data-output rate to 60Hz (see Table I and Figure 5). If both 50Hz and 60Hz rejection is required, then the system CLK must be 3.840kHz; this will set the data-output rate to 10Hz and reject both 50Hz and 60Hz (see Table I and Figure 6).

There is an additional benefit in using a lower data-output rate: it provides better rejection of signals in the frequency band of interest. For example, with a 50Hz data-output rate, a significant signal at 75Hz can alias back into the passband at 25Hz; this is due to the fact that rejection at 75Hz must only be 66dB in the stopband—frequencies higher than the first-notch frequency (see Figure 4). However, setting the data-output rate to 10Hz will provide 135dB rejection at 75Hz (see Figure 6). A similar benefit is gained at frequencies near the data-output rate (see Figures 7, 8, 9, and 10). For example, with a 50Hz data-output rate, rejection at 55Hz may only be 105dB (see Figure 7); however, with a 10Hz data-output rate, rejection at 55Hz will be 122dB (see Figure 8). If a slower data-output rate does not meet the system requirements, then the analog front end can be designed to provide the needed attenuation to prevent aliasing. Additionally, the data-output rate can be increased and additional digital filtering can be done in the processor or controller.

Application note SBAA103, *A Spreadsheet to Calculate the Frequency Response of the ADS1250-54* (available for download at www.ti.com) provides a simple tool for calculating the ADS1250 frequency response for any CLK frequency.

The digital filter is described by the following transfer function:

$$|H(f)| = \frac{\left| \sin\left(\frac{\pi \cdot f \cdot 64}{f_{\text{MOD}}}\right) \right|^5}{64 \cdot \sin\left(\frac{\pi \cdot f}{f_{\text{MOD}}}\right)}$$

or

$$H(z) = \left(\frac{1 - z^{-64}}{64 \cdot (1 - z^{-1})} \right)^5$$

The digital filter requires five conversions to fully settle. The modulator has an oversampling ratio of 64; therefore, it requires $5 \cdot 64$, or 320 modulator results, or clocks, to fully settle. As the modulator clock is derived from the system clock (CLK) (modulator clock = CLK ÷ 6), the number of system clocks required for the digital filter to fully settle is $5 \cdot 64 \cdot 6$, or 1920 CLKs. This means that any significant step change at the analog input requires five full conversions to settle. However, if the analog input change occurs asynchronously to the DOUT/ $\overline{\text{DRDY}}$ pulse, then six conversions are required to ensure full settling.

CONTROL LOGIC

The control logic is used for communications and control of the ADS1252.

Power-Up Sequence

Prior to power-up, all digital and analog-input pins must be LOW. At the time of power-up, these signal inputs can be biased to a voltage other than 0V, however, they must never exceed $+V_{\text{DD}}$.

Once the ADS1252 powers up, the DOUT/ $\overline{\text{DRDY}}$ line pulses LOW on the first conversion; this data is not valid. The sixth pulse of DOUT/ $\overline{\text{DRDY}}$ is valid data from the analog input signal.

DOUT/ $\overline{\text{DRDY}}$

The DOUT/ $\overline{\text{DRDY}}$ output signal alternates between two modes of operation. The first mode of operation is the Data Ready ($\overline{\text{DRDY}}$) mode to indicate that new data has been loaded into the data-output register and is ready to be read. The second mode of operation is the Data Output (DOUT) mode and is used to serially shift data out of the Data Output Register (DOR). See Figure 11 for the time domain partitioning of the $\overline{\text{DRDY}}$ and DOUT function.

See Figure 12 for the basic timing of DOUT/ $\overline{\text{DRDY}}$. During the time defined by t_2 , t_3 , and t_4 , the DOUT/ $\overline{\text{DRDY}}$ pin functions in $\overline{\text{DRDY}}$ mode. The state of the DOUT/ $\overline{\text{DRDY}}$ pin is HIGH prior to the internal transfer of new data to the DOR. The result of the A/D conversion is written

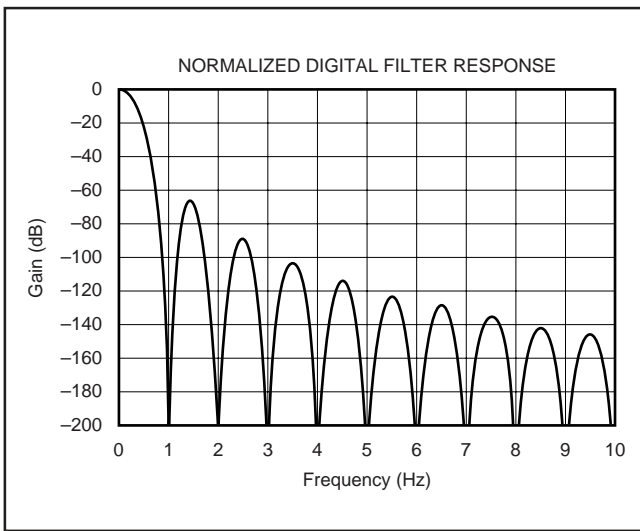

FIGURE 3. Normalized Digital Filter Response.

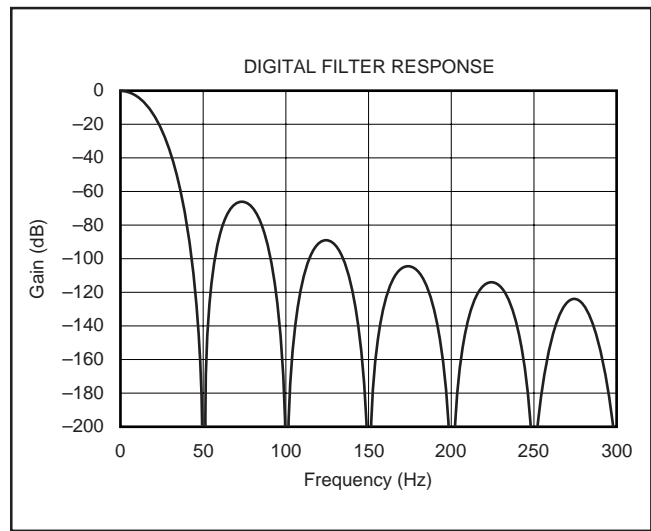

FIGURE 4. Digital Filter Response (50Hz).

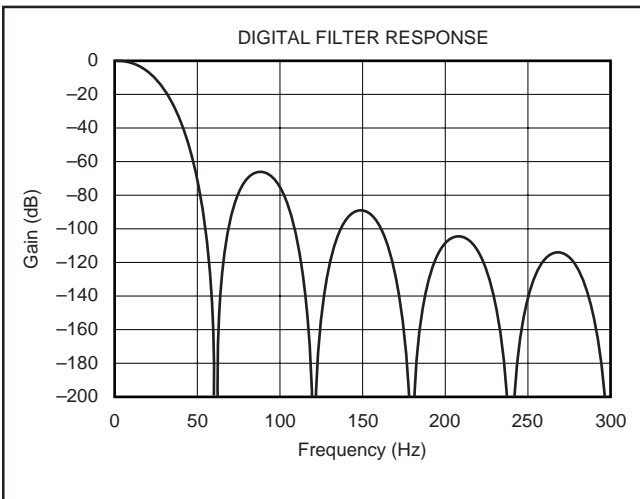

FIGURE 5. Digital Filter Response (60Hz).

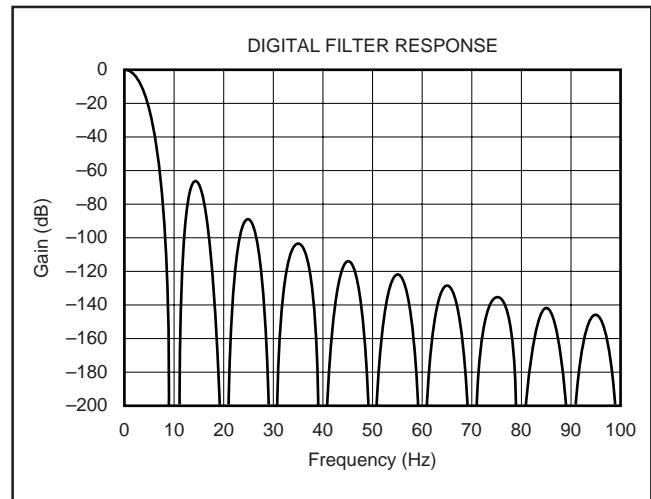

FIGURE 6. Digital Filter Response (10Hz Multiples).

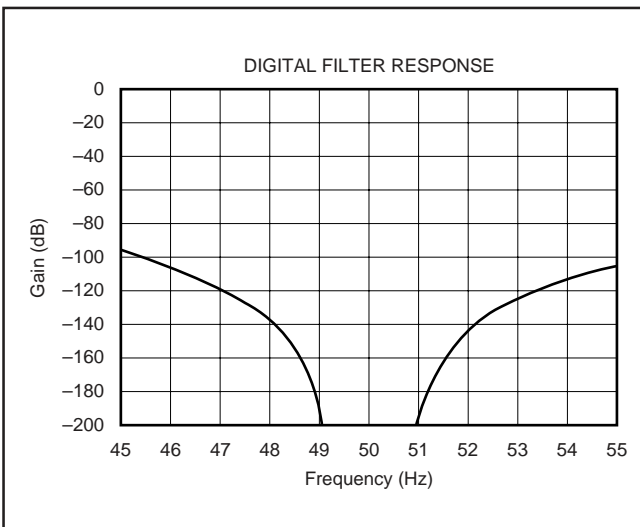

FIGURE 7. Expanded Digital Filter Response (50Hz with a 50Hz Notch).

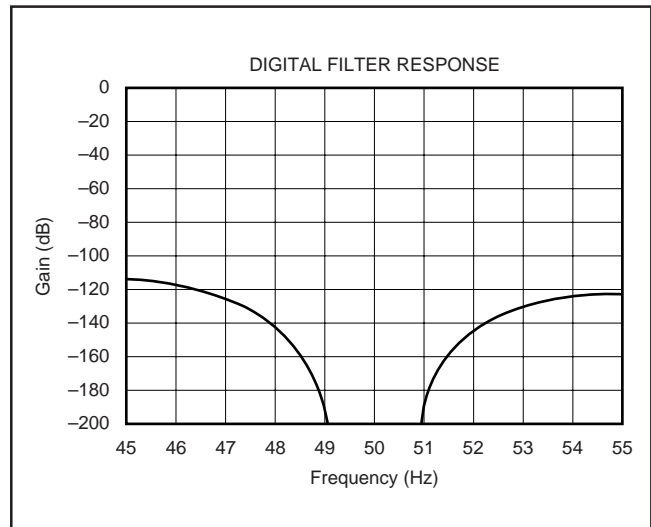

FIGURE 8. Expanded Digital Filter Response (50Hz with a 10Hz Notch).

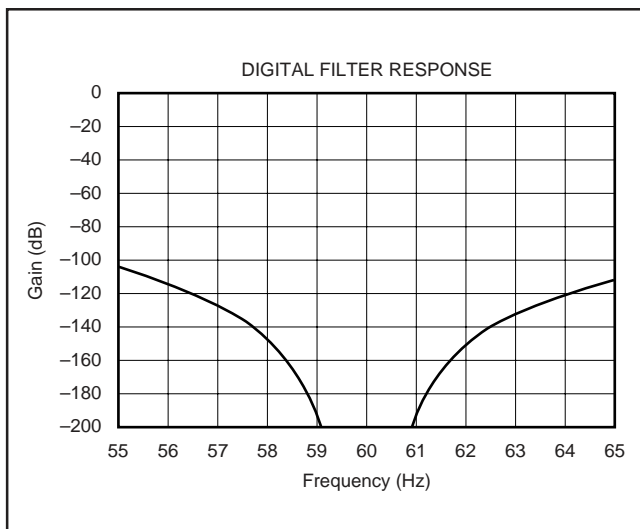

FIGURE 9. Expanded Digital Filter Response (60Hz with a 60Hz Notch).

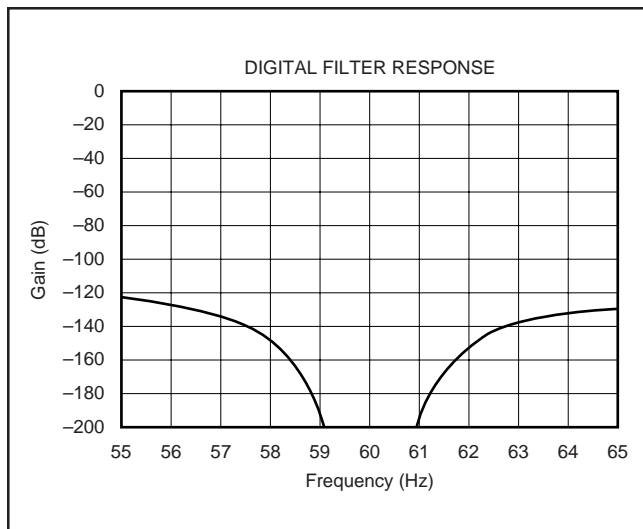

FIGURE 10. Expanded Digital Filter Response (60Hz with a 10Hz Notch).

to the DOR from MSB to LSB in the time defined by t_1 (see Figures 11 and 12). The DOUT/ $\overline{\text{DRDY}}$ line then drives the line LOW for the time defined by t_2 , and then drives the line HIGH for the time defined by t_3 to indicate that new data is available to be read. At this point, the function of the DOUT/ $\overline{\text{DRDY}}$ pin changes to DOUT mode, and data is shifted out on the pin after t_7 . If the MSB is high (because of a negative result) the DOUT/ $\overline{\text{DRDY}}$ signal will stay HIGH after the end of time t_3 . The device communicating with the ADS1252 can provide SCLKs to the ADS1252 after the time defined by t_6 . The normal mode of reading data from the ADS1252 is for the device reading the ADS1252 to latch the data on the rising edge of SCLK (since data is shifted out of the ADS1252 on the falling edge of SCLK). In order to retrieve valid data, the entire DOR must be read before the DOUT/ $\overline{\text{DRDY}}$ pin reverts back to $\overline{\text{DRDY}}$ mode.

If SCLKs are not provided to the ADS1252 during the DOUT mode, the MSB of the DOR is present on the DOUT/ $\overline{\text{DRDY}}$ line until the beginning of the time defined by t_4 . If an incomplete read of the ADS1252 takes place in DOUT mode (that is, fewer than 24 SCLKs are provided), the state of the last bit read is present on the DOUT/ $\overline{\text{DRDY}}$ line until the beginning of the time defined by t_4 . If more than 24 SCLKs are provided during DOUT mode, the DOUT/ $\overline{\text{DRDY}}$ line stays LOW until the beginning of the time defined by t_4 .

The internal data pointer for shifting data out on DOUT/ $\overline{\text{DRDY}}$ is reset on the falling edge of the time defined by t_1 and t_4 . This ensures that the first bit of data shifted out of the ADS1252 after $\overline{\text{DRDY}}$ mode is always the MSB of new data.

SYNCHRONIZING MULTIPLE CONVERTERS

The normal state of SCLK is LOW; however, by holding SCLK HIGH, multiple ADS1252s can be synchronized. This is accomplished by holding SCLK HIGH for at least four, but less than 20, consecutive DOUT/ $\overline{\text{DRDY}}$ cycles (see Figure 13). After the ADS1252 circuitry detects that SCLK has been held HIGH for four consecutive DOUT/ $\overline{\text{DRDY}}$ cycles, the DOUT/ $\overline{\text{DRDY}}$ pin pulses LOW for 3 CLK cycles and then held HIGH, and the modulator is held in a reset state. The modulator is released from reset and synchronization occurs on the falling edge of SCLK. It is important to note that prior to synchronization, the DOUT/ $\overline{\text{DRDY}}$ pulse of multiple ADS1252s in the system can have a difference in timing up to one $\overline{\text{DRDY}}$ period. Therefore, to ensure synchronization, the SCLK must be held HIGH for at least five $\overline{\text{DRDY}}$ cycles. The first DOUT/ $\overline{\text{DRDY}}$ pulse after the falling edge of SCLK occurs at t_{14} . Valid data is not present until the sixth DOUT/ $\overline{\text{DRDY}}$ pulse.

POWER-DOWN MODE

The normal state of SCLK is LOW; however, by holding SCLK HIGH, the ADS1252 enters power-down mode. This is accomplished by holding SCLK HIGH for at least 20 consecutive DOUT/ $\overline{\text{DRDY}}$ periods (see Figure 14). After the ADS1252 circuitry detects that SCLK is held HIGH for four consecutive DOUT/ $\overline{\text{DRDY}}$ cycles, the DOUT/ $\overline{\text{DRDY}}$ pin pulses LOW for three CLK cycles, then held HIGH, and the modulator will be held in a reset state. If SCLK is held HIGH for an additional 16 DOUT/ $\overline{\text{DRDY}}$ periods, the ADS1252 enters power-down mode and the part is released from power-down mode on the falling edge of SCLK. It is important to note that the DOUT/ $\overline{\text{DRDY}}$ pin is held HIGH after four DOUT/ $\overline{\text{DRDY}}$ cycles, but power-down mode is not entered for an additional 16 DOUT/ $\overline{\text{DRDY}}$ periods. The first DOUT/ $\overline{\text{DRDY}}$ pulse after the falling edge of SCLK occurs at t_{16} ; however, subsequent DOUT/ $\overline{\text{DRDY}}$ pulses occur normally. Valid data is not present until the sixth DOUT/ $\overline{\text{DRDY}}$ pulse.

SERIAL INTERFACE

The ADS1252 includes a simple serial interface which can be connected to microcontrollers and digital signal processors in a variety of ways. Communications with the ADS1252 can commence on the first detection of the DOUT/ $\overline{\text{DRDY}}$ pulse after power up, although data is valid until the sixth conversion.

It is important to note that the data from the ADS1252 is a 24-bit result transmitted MSB-first in Offset Binary Two's Complement format, as shown in Table III.

The data must be clocked out before the ADS1252 enters $\overline{\text{DRDY}}$ mode to ensure reception of valid data, as described in the DOUT/ $\overline{\text{DRDY}}$ section of this data sheet.

DIFFERENTIAL VOLTAGE INPUT	DIGITAL OUTPUT (HEX)
+Full-Scale	7FFFFFF _H
Zero	000000 _H
-Full-Scale	800000 _H

TABLE III. ADS1252 Data Format (Offset Binary Two's Complement).

SYMBOL	DESCRIPTION	MIN	TYP	MAX	UNITS
t_{DRDY}	Conversion Cycle		384 • CLK		ns
$\overline{\text{DRDY}}$ Mode	$\overline{\text{DRDY}}$ Mode		36 • CLK		ns
DOUT Mode	DOUT Mode		348 • CLK		ns
t_1	DOR Write Time		6 • CLK		ns
t_2	DOUT/ $\overline{\text{DRDY}}$ LOW Time		6 • CLK		ns
t_3	DOUT/ $\overline{\text{DRDY}}$ HIGH Time (Prior to Data Out)		6 • CLK		ns
t_4	DOUT/ $\overline{\text{DRDY}}$ HIGH Time (Prior to Data Ready)		24 • CLK		ns
t_5	Rising Edge of CLK to Falling Edge of DOUT/ $\overline{\text{DRDY}}$			30	ns
t_6	End of $\overline{\text{DRDY}}$ Mode to Rising Edge of First SCLK	30			ns
t_7	End of $\overline{\text{DRDY}}$ Mode to Data Valid (Propagation Delay)			30	ns
t_8	Falling Edge of SCLK to Data Valid (Hold Time)	5			ns
t_9	Falling Edge of SCLK to Next Data Out Valid (Propagation Delay)			30	ns
t_{10}	SCLK Setup Time for Synchronization or Power Down	30			ns
t_{11}	DOUT/ $\overline{\text{DRDY}}$ Pulse for Synchronization or Power Down		3 • CLK		ns
t_{12}	Rising Edge of SCLK Until Start of Synchronization	1537 • CLK		7679 • CLK	ns
t_{13}	Synchronization Time	0.5 • CLK		6143.5 • CLK	ns
t_{14}	Falling Edge of CLK (After SCLK Goes LOW) Until Start of $\overline{\text{DRDY}}$ Mode		2042.5 • CLK		ns
t_{15}	Rising Edge of SCLK Until Start of Power Down	7681 • CLK			ns
t_{16}	Falling Edge of CLK (After SCLK Goes LOW) Until Start of $\overline{\text{DRDY}}$ Mode	591.5 • CLK		592.5 • CLK	ns
t_{17}	Falling Edge of Last DOUT/ $\overline{\text{DRDY}}$ to Start of Power Down		6143.5 • CLK		ns

TABLE II. Digital Timing.

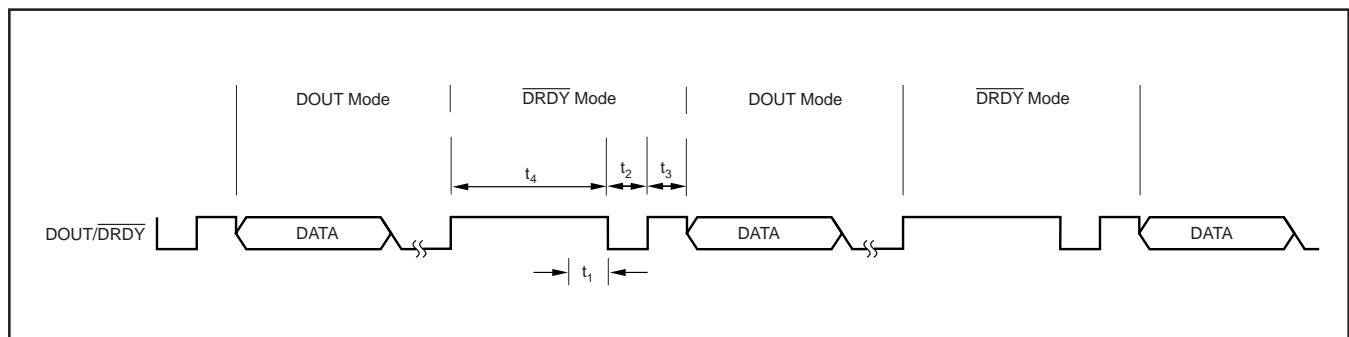

FIGURE 11. DOUT/ $\overline{\text{DRDY}}$ Partitioning.

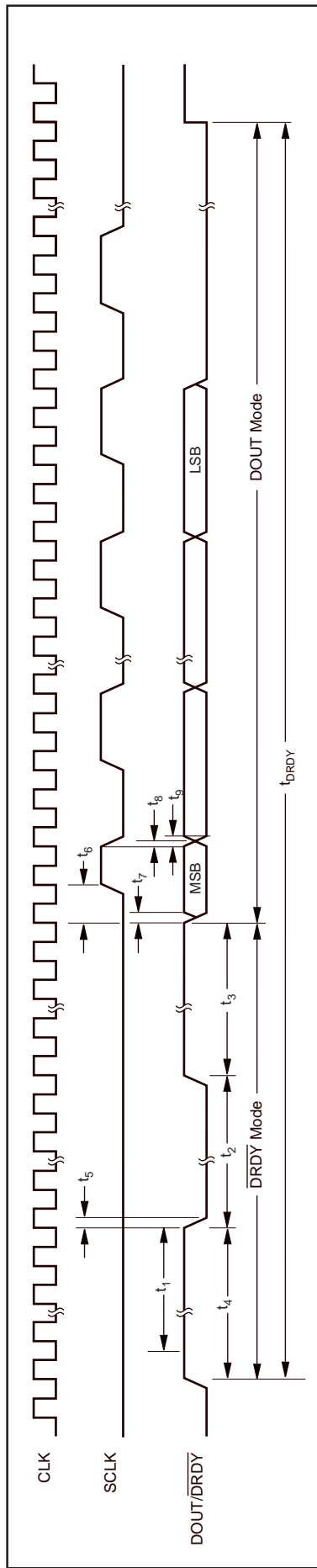

FIGURE 12. DOUT/DRDY Timing.

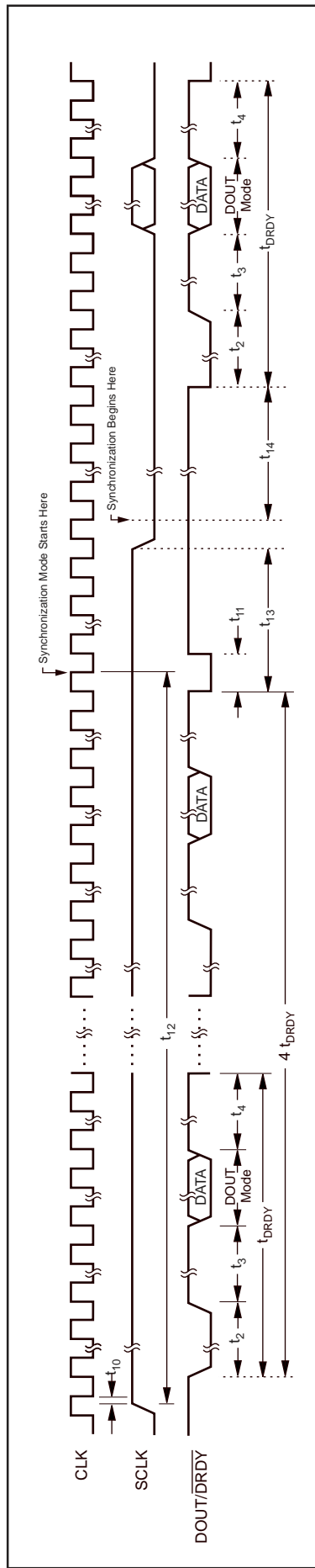

FIGURE 13. Synchronization Mode.

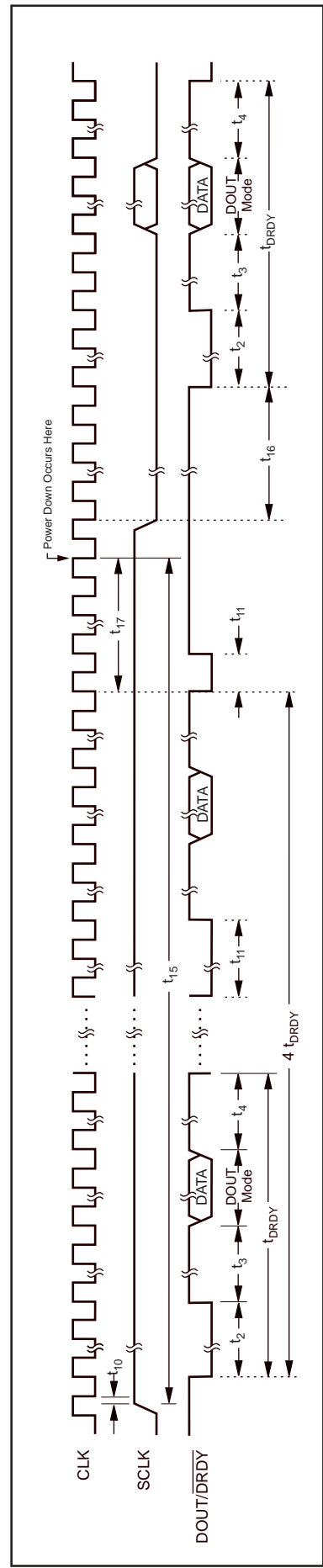

FIGURE 14. Power-Down Mode.

ISOLATION

The serial interface of the ADS1252 provides for simple isolation methods. The CLK signal can be local to the ADS1252, which then only requires two signals (SCLK and DOUT/DRDY) to be used for isolated data acquisition.

LAYOUT

POWER SUPPLY

The power supply should be well regulated and low noise. For designs requiring very high resolution from the ADS1252, power-supply rejection will be a concern. Avoid running digital lines under the device because they can couple noise onto the die. High-frequency noise can capacitively couple into the analog portion of the device and will alias back into the passband of the digital filter, affecting the conversion result.

GROUNDING

The analog and digital sections of the system design must be carefully and cleanly partitioned; each section must have its own ground plane with no overlap between them. GND must be connected to the analog ground plane, as well as all other analog grounds. Do not join the analog and digital ground planes on the board, but instead connect the two with a moderate signal trace. For multiple converters, connect the two ground planes at one location as central to all of the converters as possible. In some cases, experimentation is required to find the best point to connect the two planes together. The printed circuit board can be designed to provide different analog/digital ground connections via short jumpers; the initial prototype can be used to establish which connection works best.

DECOUPLING

Good decoupling practices must be used for the ADS1252 and for all components in the design. All decoupling capacitors, and specifically the 0.1 μ F ceramic capacitors, must be placed as close as possible to the pin being decoupled. A 1 μ F to 10 μ F capacitor, in parallel with a 0.1 μ F ceramic capacitor, must be used to decouple V_{DD} to GND.

SYSTEM CONSIDERATIONS

The recommendations for power supplies and grounding change depending on the requirements and specific design of the overall system. Achieving 24 bits of noise performance is a great deal more difficult than achieving 12 bits of noise performance. In general, a system can be broken up into four different stages:

- Analog Processing
- Analog Portion of the ADS1252
- Digital Portion of the ADS1252
- Digital Processing

For the simplest system consisting of minimal analog signal processing (basic filtering and gain), a microcontroller, and one clock source, one can achieve high resolution by powering all components by a common power supply. In addition, all components can share a common ground plane; thus, there would be no distinctions between analog power and ground, and digital power and ground. The layout must still include a power plane, a ground plane, and careful decoupling. In a more extreme case, the design can include:

- Multiple ADS1252s
- Extensive Analog Signal Processing
- One or More Microcontrollers, Digital Signal Processors, or Microprocessors
- Many Different Clock Sources
- Interconnections to Various Other Systems

High resolution will be very difficult to achieve for this design. The approach would be to break the system into as many different parts as possible. For example, each ADS1252 may have its own analog processing front end.

DEFINITION OF TERMS

An attempt has been made to be consistent with the terminology used in this data sheet. In that regard, the definition of each term is given as follows:

Analog-Input Differential Voltage—for an analog signal that is fully differential, the voltage range can be compared to that of an instrumentation amplifier. For example, if both analog inputs of the ADS1252 are at 2.048V, the differential voltage is 0V; however, if one analog input is at 0V and the other analog input is at 4.096V, then the differential voltage magnitude is 4.096V. This is the case regardless of which input is at 0V and which is at 4.096V. The digital-output

result, however, is quite different. The analog-input differential voltage is given by the following equation:

$$+V_{IN} - (-V_{IN})$$

A positive digital output is produced whenever the analog-input differential voltage is positive, whereas negative digital output is produced whenever the differential is negative. For example, a positive full-scale output is produced when the converter is configured with a 4.096V reference, and the analog-input differential is 4.096V, the negative full-scale output is produced when the differential voltage is -4.096V. In each case, the actual input voltages must remain within the -0.3V to +V_{DD} range.

Actual Analog-Input Voltage—the voltage at any one analog input relative to GND.

Full-Scale Range (FSR)—as with most A/D converters, the full-scale range of the ADS1252 is defined as the input which produces the positive full-scale digital output minus the input which produces the negative full-scale digital output. For example, when the converter is configured with a 4.096V reference, the differential full-scale range is:

$$[4.096V \text{ (positive full-scale)} - (-4.096V) \text{ (negative full-scale)}] = 8.192V$$

Least Significant Bit (LSB) Weight—this is the theoretical amount of voltage that the differential voltage at the analog input has to change in order to observe a change in the output data of one least significant bit. It is computed as follows:

$$\text{LSB Weight} = \frac{\text{Full-Scale Range}}{2^N}$$

where N is the number of bits in the digital output.

Conversion Cycle—as used here, a conversion cycle refers to the time period between DOUT/ $\overline{\text{DRDY}}$ pulses.

Effective Resolution (ER)—of the ADS1252 in a particular configuration can be expressed in two different units: bits rms (referenced to output) and μVrms (referenced to input). Computed directly from the converter output data,

each is a statistical calculation based on a given number of results. Noise occurs randomly; the rms value represents a statistical measure which is one standard deviation. The ER in bits can be computed as follows:

$$\text{ER in bits rms} = \frac{20 \cdot \log \left(\frac{2 \cdot V_{REF}}{V_{rms \text{ noise}}} \right)}{6.02}$$

The $2 \cdot V_{REF}$ figure in each calculation represents the full-scale range of the ADS1252, this means that both units are absolute expressions of resolution—the performance in different configurations can be directly compared, regardless of the units.

Noise Reduction—for random noise, the ER can be improved with averaging. The result is the reduction in noise by the factor \sqrt{N} , where N is the number of averages, as shown in Table IV; this can be used to achieve true 24-bit performance at a lower data rate. To achieve 24 bits of resolution, more than 24 bits must be accumulated. A 36-bit accumulator is required to achieve an ER of 24 bits. The following uses $V_{REF} = 4.096V$, with the ADS1252 outputting data at 40kHz, a 4096 point average takes 102.4ms. The benefits of averaging is degraded if the input signal drifts during that 100ms.

N (NUMBER OF AVERAGES)	NOISE REDUCTION FACTOR	ER IN μVrms	ER IN BITS rms
1	1	31.3 μV	18
2	1.414	22.1 μV	18.5
4	2	15.6 μV	19
8	2.82	11.1 μV	19.5
16	4	7.82 μV	20
32	5.66	5.53 μV	20.5
64	8	3.91 μV	21
128	11.3	2.77 μV	21.5
256	16	1.96 μV	22
512	22.6	1.38 μV	22.5
1024	32	978nV	23
2048	45.25	692nV	23.5
4096	64	489nV	24

TABLE IV. Averaging.

Revision History

DATE	REVISION	PAGE	SECTION	DESCRIPTION
6/06	D	11	DO $\overline{\text{UT}}$ /DRDY	Text changes to DO $\overline{\text{UT}}$ /DRDY section.

NOTE: Page numbers for previous revisions may differ from page numbers in the current version.

PACKAGING INFORMATION

Orderable Device	Status (1)	Package Type	Package Drawing	Pins	Package Qty	Eco Plan (2)	Lead finish/ Ball material (6)	MSL Peak Temp (3)	Op Temp (°C)	Device Marking (4/5)	Samples
ADS1252U	ACTIVE	SOIC	D	8	75	RoHS & Green	NIPDAU	Level-2-260C-1 YEAR	-40 to 85	ADS 1252U	Samples
ADS1252U/2K5	ACTIVE	SOIC	D	8	2500	RoHS & Green	NIPDAU	Level-2-260C-1 YEAR	-40 to 85	ADS 1252U	Samples
ADS1252U/2K5G4	ACTIVE	SOIC	D	8	2500	RoHS & Green	NIPDAU	Level-2-260C-1 YEAR	-40 to 85	ADS 1252U	Samples
ADS1252UG4	ACTIVE	SOIC	D	8	75	RoHS & Green	NIPDAU	Level-2-260C-1 YEAR	-40 to 85	ADS 1252U	Samples

(1) The marketing status values are defined as follows:

ACTIVE: Product device recommended for new designs.

LIFEBUY: TI has announced that the device will be discontinued, and a lifetime-buy period is in effect.

NRND: Not recommended for new designs. Device is in production to support existing customers, but TI does not recommend using this part in a new design.

PREVIEW: Device has been announced but is not in production. Samples may or may not be available.

OBSELETE: TI has discontinued the production of the device.

(2) **RoHS:** TI defines "RoHS" to mean semiconductor products that are compliant with the current EU RoHS requirements for all 10 RoHS substances, including the requirement that RoHS substance do not exceed 0.1% by weight in homogeneous materials. Where designed to be soldered at high temperatures, "RoHS" products are suitable for use in specified lead-free processes. TI may reference these types of products as "Pb-Free".

RoHS Exempt: TI defines "RoHS Exempt" to mean products that contain lead but are compliant with EU RoHS pursuant to a specific EU RoHS exemption.

Green: TI defines "Green" to mean the content of Chlorine (Cl) and Bromine (Br) based flame retardants meet JS709B low halogen requirements of <=1000ppm threshold. Antimony trioxide based flame retardants must also meet the <=1000ppm threshold requirement.

(3) MSL, Peak Temp. - The Moisture Sensitivity Level rating according to the JEDEC industry standard classifications, and peak solder temperature.

(4) There may be additional marking, which relates to the logo, the lot trace code information, or the environmental category on the device.

(5) Multiple Device Markings will be inside parentheses. Only one Device Marking contained in parentheses and separated by a "~" will appear on a device. If a line is indented then it is a continuation of the previous line and the two combined represent the entire Device Marking for that device.

(6) Lead finish/Ball material - Orderable Devices may have multiple material finish options. Finish options are separated by a vertical ruled line. Lead finish/Ball material values may wrap to two lines if the finish value exceeds the maximum column width.

Important Information and Disclaimer:The information provided on this page represents TI's knowledge and belief as of the date that it is provided. TI bases its knowledge and belief on information provided by third parties, and makes no representation or warranty as to the accuracy of such information. Efforts are underway to better integrate information from third parties. TI has taken and

continues to take reasonable steps to provide representative and accurate information but may not have conducted destructive testing or chemical analysis on incoming materials and chemicals. TI and TI suppliers consider certain information to be proprietary, and thus CAS numbers and other limited information may not be available for release.

In no event shall TI's liability arising out of such information exceed the total purchase price of the TI part(s) at issue in this document sold by TI to Customer on an annual basis.

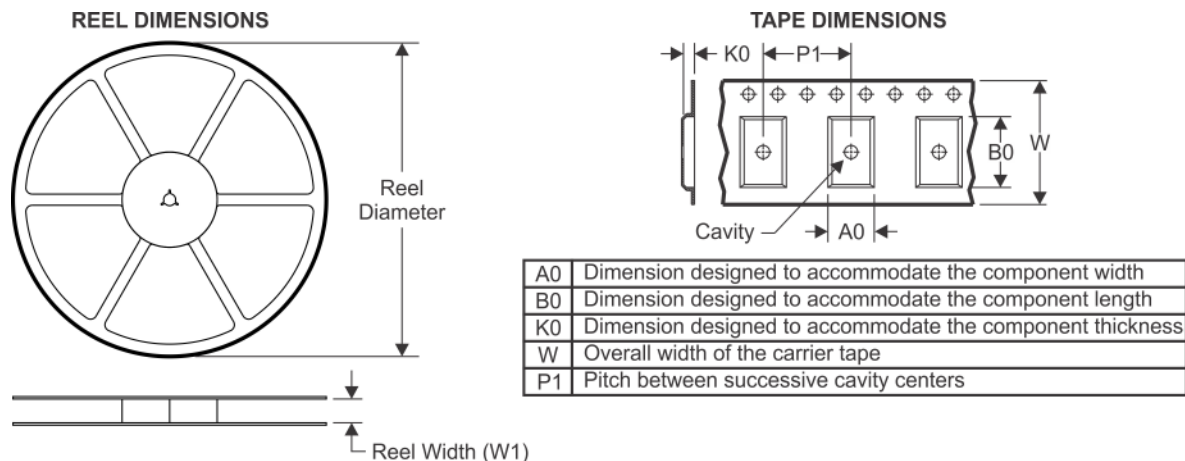
TAPE AND REEL INFORMATION

QUADRANT ASSIGNMENTS FOR PIN 1 ORIENTATION IN TAPE

*All dimensions are nominal

Device	Package Type	Package Drawing	Pins	SPQ	Reel Diameter (mm)	Reel Width W1 (mm)	A0 (mm)	B0 (mm)	K0 (mm)	P1 (mm)	W (mm)	Pin1 Quadrant
ADS1252U/2K5	SOIC	D	8	2500	330.0	12.4	6.4	5.2	2.1	8.0	12.0	Q1

TAPE AND REEL BOX DIMENSIONS

*All dimensions are nominal

Device	Package Type	Package Drawing	Pins	SPQ	Length (mm)	Width (mm)	Height (mm)
ADS1252U/2K5	SOIC	D	8	2500	367.0	367.0	35.0

TUBE

*All dimensions are nominal

Device	Package Name	Package Type	Pins	SPQ	L (mm)	W (mm)	T (μm)	B (mm)
ADS1252U	D	SOIC	8	75	506.6	8	3940	4.32
ADS1252UG4	D	SOIC	8	75	506.6	8	3940	4.32

D0008A

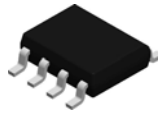

PACKAGE OUTLINE

SOIC - 1.75 mm max height

SMALL OUTLINE INTEGRATED CIRCUIT

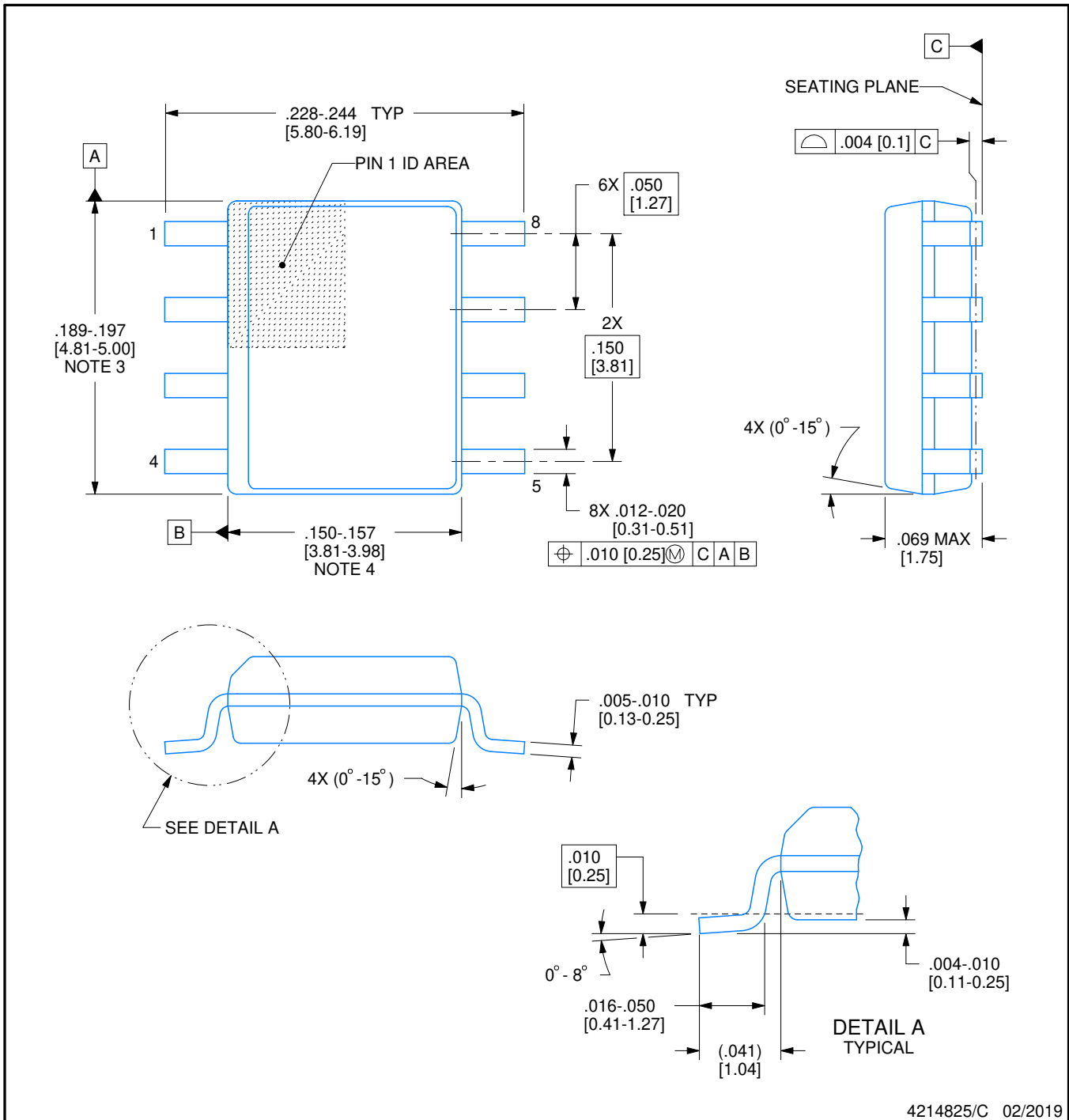

4214825/C 02/2019

NOTES:

1. Linear dimensions are in inches [millimeters]. Dimensions in parenthesis are for reference only. Controlling dimensions are in inches. Dimensioning and tolerancing per ASME Y14.5M.
2. This drawing is subject to change without notice.
3. This dimension does not include mold flash, protrusions, or gate burrs. Mold flash, protrusions, or gate burrs shall not exceed .006 [0.15] per side.
4. This dimension does not include interlead flash.
5. Reference JEDEC registration MS-012, variation AA.

EXAMPLE BOARD LAYOUT

D0008A

SOIC - 1.75 mm max height

SMALL OUTLINE INTEGRATED CIRCUIT



LAND PATTERN EXAMPLE
EXPOSED METAL SHOWN
SCALE:8X



SOLDER MASK DETAILS

4214825/C 02/2019

NOTES: (continued)

- 6. Publication IPC-7351 may have alternate designs.
- 7. Solder mask tolerances between and around signal pads can vary based on board fabrication site.

EXAMPLE STENCIL DESIGN

D0008A

SOIC - 1.75 mm max height

SMALL OUTLINE INTEGRATED CIRCUIT



SOLDER PASTE EXAMPLE
BASED ON .005 INCH [0.125 MM] THICK STENCIL
SCALE:8X

4214825/C 02/2019

NOTES: (continued)

8. Laser cutting apertures with trapezoidal walls and rounded corners may offer better paste release. IPC-7525 may have alternate design recommendations.
9. Board assembly site may have different recommendations for stencil design.

IMPORTANT NOTICE AND DISCLAIMER

TI PROVIDES TECHNICAL AND RELIABILITY DATA (INCLUDING DATA SHEETS), DESIGN RESOURCES (INCLUDING REFERENCE DESIGNS), APPLICATION OR OTHER DESIGN ADVICE, WEB TOOLS, SAFETY INFORMATION, AND OTHER RESOURCES "AS IS" AND WITH ALL FAULTS, AND DISCLAIMS ALL WARRANTIES, EXPRESS AND IMPLIED, INCLUDING WITHOUT LIMITATION ANY IMPLIED WARRANTIES OF MERCHANTABILITY, FITNESS FOR A PARTICULAR PURPOSE OR NON-INFRINGEMENT OF THIRD PARTY INTELLECTUAL PROPERTY RIGHTS.

These resources are intended for skilled developers designing with TI products. You are solely responsible for (1) selecting the appropriate TI products for your application, (2) designing, validating and testing your application, and (3) ensuring your application meets applicable standards, and any other safety, security, regulatory or other requirements.

These resources are subject to change without notice. TI grants you permission to use these resources only for development of an application that uses the TI products described in the resource. Other reproduction and display of these resources is prohibited. No license is granted to any other TI intellectual property right or to any third party intellectual property right. TI disclaims responsibility for, and you will fully indemnify TI and its representatives against, any claims, damages, costs, losses, and liabilities arising out of your use of these resources.

TI's products are provided subject to [TI's Terms of Sale](#) or other applicable terms available either on ti.com or provided in conjunction with such TI products. TI's provision of these resources does not expand or otherwise alter TI's applicable warranties or warranty disclaimers for TI products.

TI objects to and rejects any additional or different terms you may have proposed.

Mailing Address: Texas Instruments, Post Office Box 655303, Dallas, Texas 75265
Copyright © 2022, Texas Instruments Incorporated