

# HLMP-DS25/DM25/NS30/NM31

## T-1<sup>3/4</sup> (5 mm), T-1 (3 mm) InGaN LED Lamps

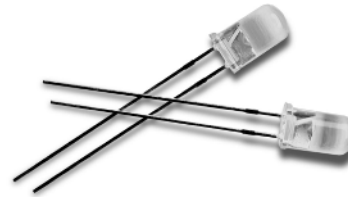

### Data Sheet



#### Description

The blue HLMP-DS25 and HLMP-NS30, and green HLMP-DM25 and HLMP-NM31 LEDs are designed in an industry standard T-1<sup>3/4</sup> and T-1 packages with clear and nondiffused optics.

These lamps are ideal for use as indicators and for general purpose lighting. Blue lamps offer color differentiation as blue is attractive and not widely available.

#### Features

- Popular T-1<sup>3/4</sup> and T-1 diameter packages
- General purpose leads
- Reliable and rugged
- Binned for color and intensity
- Bright InGaN dice

#### Applications

- Status indicators
- Small message panel
- Running and decorative lights for commercial use
- Back lighting
- Consumer audio

#### Package Dimensions

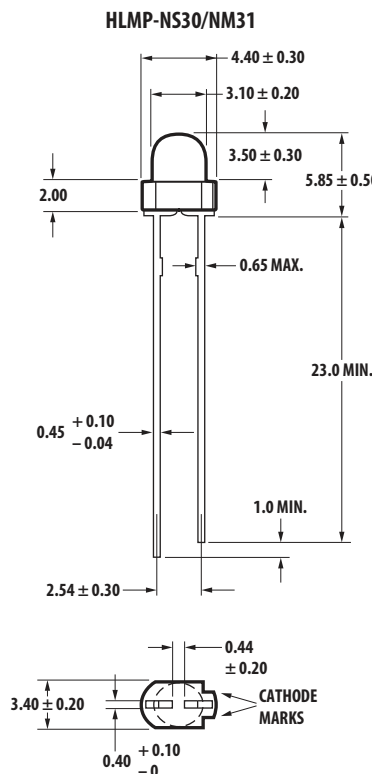
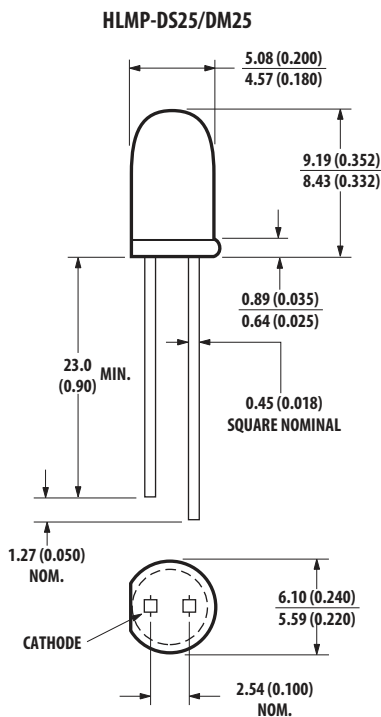

- NOTES:
1. ALL DIMENSIONS ARE IN MILLIMETERS (INCHES).
  2. EPOXY MENISCUS MAY EXTEND 1 mm (0.040") MAX DOWN THE LEADS.

**CAUTION:** Devices are Class 1C HBM ESD sensitive per JEDEC Standard. Please observe appropriate precautions during handling and processing. For additional details, refer to Application Note AN-1142.

## Selection Guide

Package Description	Color	Part Number	Luminous Intensity $I_v$ (mcd) at 20 mA	
			Min.	Max.
T-1 $\frac{3}{4}$	Blue	HLMP-DS25-F0000	110	–
	Blue	HLMP-DS25-F00DD	110	–
	Green	HLMP-DM25-J0000	240	–
T-1	Blue	HLMP-NS30-J0000	240	–
	Blue	HLMP-NS30-J00DD	240	–
	Green	HLMP-NM31-R0000	1500	–
	Green	HLMP-NM31-R00DD	1500	–

## Part Numbering System

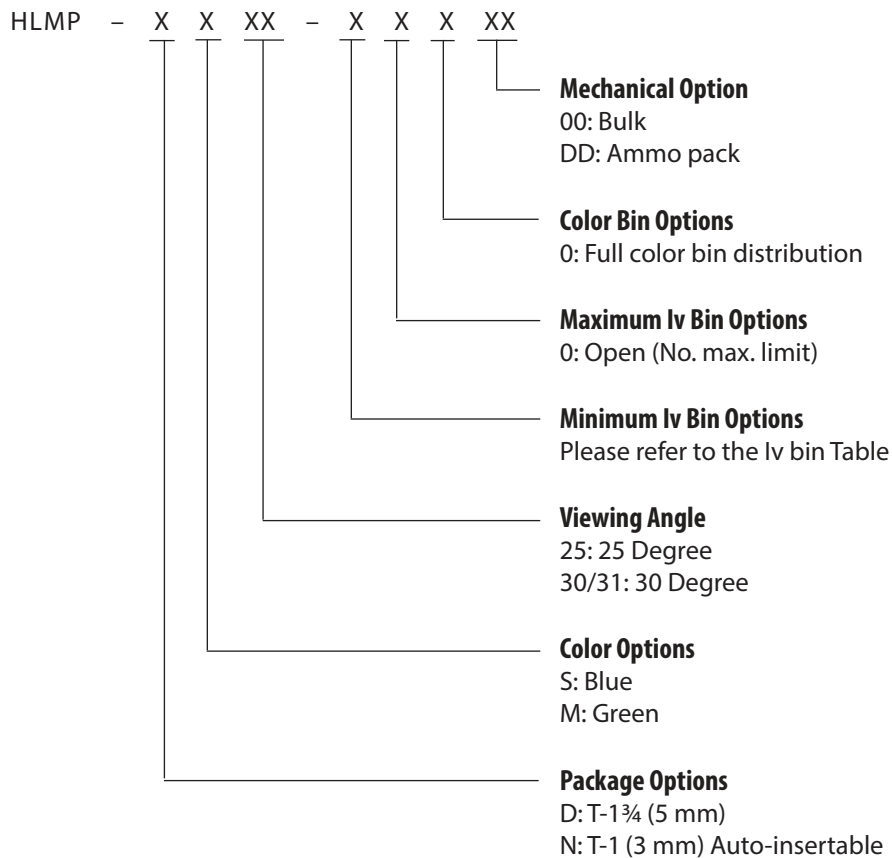

### Absolute Maximum Ratings ( $T_A = 25\text{ }^\circ\text{C}$ )

Parameter	HLMP-DS25/DM25	HLMP-NS30/NM31
Peak Pulsed Forward Current [1]	100 mA	100 mA
DC Forward Current [2]	30 mA	30 mA
Reverse Voltage	Not recommended for reverse bias	
Power dissipation	116 mW	116 mW
LED Junction Temperature	115 °C	115 °C
Operating Temperature	-40 to +85 °C	-40 to +85 °C
Storage Temperature	-40 to +100 °C	-40 to +85 °C

Notes:

1. Duty factor = 10%, Frequency = 1 kHz.
2. Derate linearly as shown in Figure 4.

### Optical Characteristics ( $T_A = 25\text{ }^\circ\text{C}$ )

Part Number	Luminous Intensity $I_V$ (mcd) @ $I_F = 20\text{ mA}$	Color, Dominant Wavelength $\lambda_d$ [1] (nm)	Peak Wavelength $\lambda_{PEAK}$ (nm)	Viewing Angle $2\theta_{1/2}$ [2] degrees
	Min.	Typ.	Typ.	Typ.
HLMP-DS25	110	470	468	25
HLMP-DM25	240	527	520	25
HLMP-NS30	240	470	468	30
HLMP-NM31	1500	527	520	30

Notes:

1. The dominant wavelength,  $\lambda_d$ , is derived from the CIE Chromaticity Diagram and represents the single wavelength which defines the color of the device.
2.  $\theta_{1/2}$  is the off-axis angle at which the luminous intensity is half of the axial luminous intensity.

### Electrical Characteristics

Part Number	Forward Voltage $V_F$ (V) $I_F = 20\text{ mA}$			Speed Response $t_s$ (ns)	Capacitance $C$ (pF), $V_F = 0, f = 1\text{ MHz}$	Thermal Resistance $R_{\theta J-PIN}$ ( $^\circ\text{C/W}$ ) Junction to Cathode Lead
	Min.	Typ.	Max.	Typ.	Typ.	
HLMP-DS25	2.8	3.2	3.8	500	50	260
HLMP-DM25	2.8	3.2	3.8	500	50	260
HLMP-NS30	2.8	3.2	3.8	500	50	290
HLMP-NM31	2.8	3.2	3.8	500	50	290

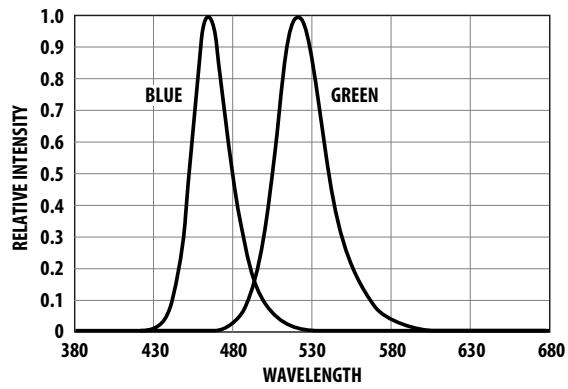

Figure 1. Relative intensity vs. wavelength

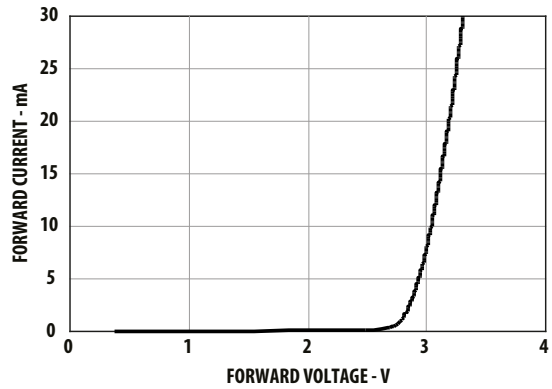

Figure 2. Forward current vs. forward voltage

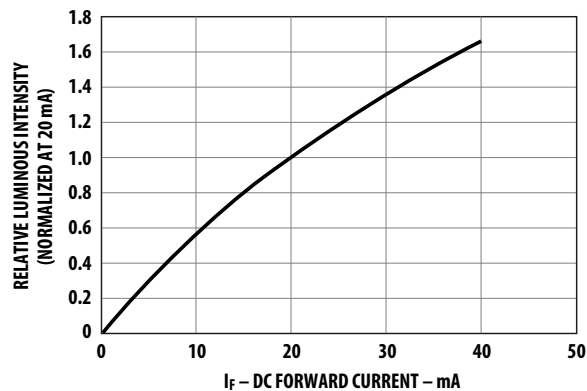

Figure 3. Relative luminous intensity vs. forward current

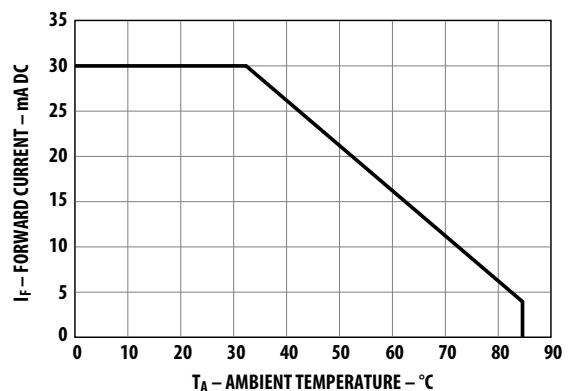

Figure 4. Maximum forward current vs. ambient temperature based on  $T_j \text{ max.} = 115^\circ\text{C}$

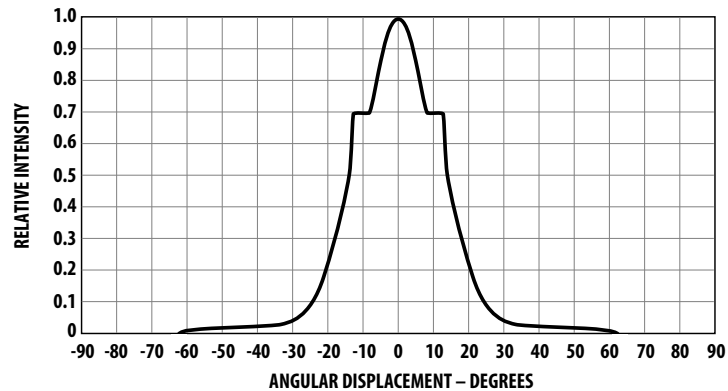

Figure 5. Relative luminous intensity vs. angular displacement for HLMP-DS25 and HLMP-DM25

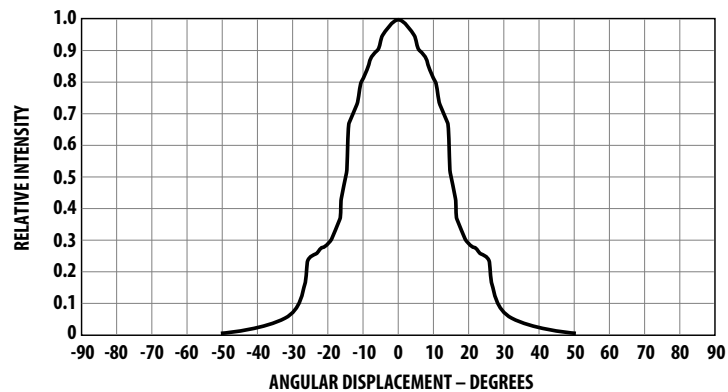

Figure 6. Relative luminous intensity vs. angular displacement for HLMP-NS30 and HLMP-NM31

**Bin Limits**

Bin	Intensity Range (mcd)	
	Min.	Max.
F	110.0	140.0
G	140.0	180.0
H	180.0	240.0
J	240.0	310.0
K	310.0	400.0
L	400.0	520.0
M	520.0	680.0
N	680.0	880.0
P	880.0	1150.0
Q	1150.0	1500.0
R	1500.0	1900.0
S	1900.0	2500.0
T	2500.0	3200.0
U	3200.0	4200.0

Tolerance for each minimum and maximum =  $\pm 15\%$ .

**Color Bin Limits (nm at 20 mA)**

Blue		
nm @ 20 mA		
Bin ID	Min.	Max.
1	460.0	464.0
2	464.0	468.0
3	468.0	472.0
4	472.0	476.0
5	476.0	480.0

Green		
nm @ 20 mA		
Bin ID	Min.	Max.
1	520.0	524.0
2	524.0	528.0
3	528.0	532.0
4	532.0	536.0
5	536.0	540.0

Tolerance for each bin limit will be  $\pm 0.5$  nm.

**Mechanical Option Matrix**

Mechanical Option Code	Definition
O0	Bulk Packaging, minimum increment 500 pcs/bag
DD	Ammo Pack, straight leads, minimum increment 2K pcs/pack

All categories are established for classification of products. Products may not be available in all categories. Please contact your local Avago representative for further clarification/information.

## Precautions

### Lead Forming

- The leads of an LED lamp may be preformed or cut to length prior to insertion and soldering on PC board.
- For better control, it is recommended to use proper tool to precisely form and cut the leads to applicable length rather than doing it manually.
- If manual lead cutting is necessary, cut the leads after the soldering process. The solder connection forms a mechanical ground which prevents mechanical stress due to lead cutting from traveling into LED package. This is highly recommended for hand solder operation, as the excess lead length also acts as small heat sink.

### Soldering and Handling

- Care must be taken during PCB assembly and soldering process to prevent damage to the LED component.
- LED component may be effectively hand soldered to PCB. However, it is only recommended under unavoidable circumstances such as rework. The closest manual soldering distance of the soldering heat source (soldering iron's tip) to the body is 1.59mm. Soldering the LED using soldering iron tip closer than 1.59mm might damage the LED.

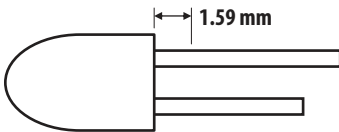

- ESD precaution must be properly applied on the soldering station and personnel to prevent ESD damage to the LED component that is ESD sensitive. Do refer to Avago application note AN 1142 for details. The soldering iron used should have grounded tip to ensure electrostatic charge is properly grounded.
- Recommended soldering condition:

	Wave Soldering [1, 2]	Manual Solder Dipping
Pre-heat Temperature	105°C Max.	–
Pre-heat Time	60 sec Max.	–
Peak Temperature	250°C Max.	260°C Max.
Dwell Time	3 sec Max.	5 sec Max.

#### Notes:

1. These conditions refer to measurement with thermocouple mounted at the bottom of PCB.
2. To reduce thermal stress experienced by LED, it is recommended that you use only bottom preheaters.

- Wave soldering parameters must be set and maintained according to the recommended temperature and dwell time. Customer is advised to perform daily check on the soldering profile to ensure that it is always conforming to recommended soldering conditions.

#### Notes:

1. PCB with different size and design (component density) will have different heat mass (heat capacity). This might cause a change in temperature experienced by the board if same wave soldering setting is used. So, it is recommended to re-calibrate the soldering profile again before loading a new type of PCB.
  2. Customer is advised to take extra precaution during wave soldering to ensure that the maximum wave temperature does not exceed 250°C and the solder contact time does not exceeding 3sec. Over-stressing the LED during soldering process might cause premature failure to the LED due to delamination.
- Any alignment fixture that is being applied during wave soldering should be loosely fitted and should not apply weight or force on LED. Non metal material is recommended as it will absorb less heat during wave soldering process.
  - At elevated temperature, LED is more susceptible to mechanical stress. Therefore, PCB must allowed to cool down to room temperature prior to handling, which includes removal of alignment fixture or pallet.
  - If PCB board contains both through hole (TH) LED and other surface mount components, it is recommended that surface mount components be soldered on the top side of the PCB. If surface mount need to be on the bottom side, these components should be soldered using reflow soldering prior to insertion the TH LED.
  - Recommended PC board plated through holes (PTH) size for LED component leads:

	LED Component Lead Size	Diagonal	Plated Through-Hole Diameter
Lead size (typ.)	0.45 × 0.45 mm (0.018 × 0.018 in.)	0.636 mm (0.025 in)	0.98 to 1.08 mm (0.039 to 0.043 in)
Dambar shear-off area (max.)	0.65 mm (0.026 in)	0.919 mm (0.036 in)	
Lead size (typ.)	0.50 × 0.50 mm (0.020 × 0.020 in.)	0.707 mm (0.028 in)	1.05 to 1.15 mm (0.041 to 0.045 in)
Dambar shear-off area (max.)	0.70 mm (0.028 in)	0.99 mm (0.039 in)	

- Over-sizing the PTH can lead to twisted LED after clinching. On the other hand under sizing the PTH can cause difficulty inserting the TH LED.

For more information about soldering and handling of TH LED lamps, refer to application note AN5334.

Example of Wave Soldering Temperature Profile for TH LED

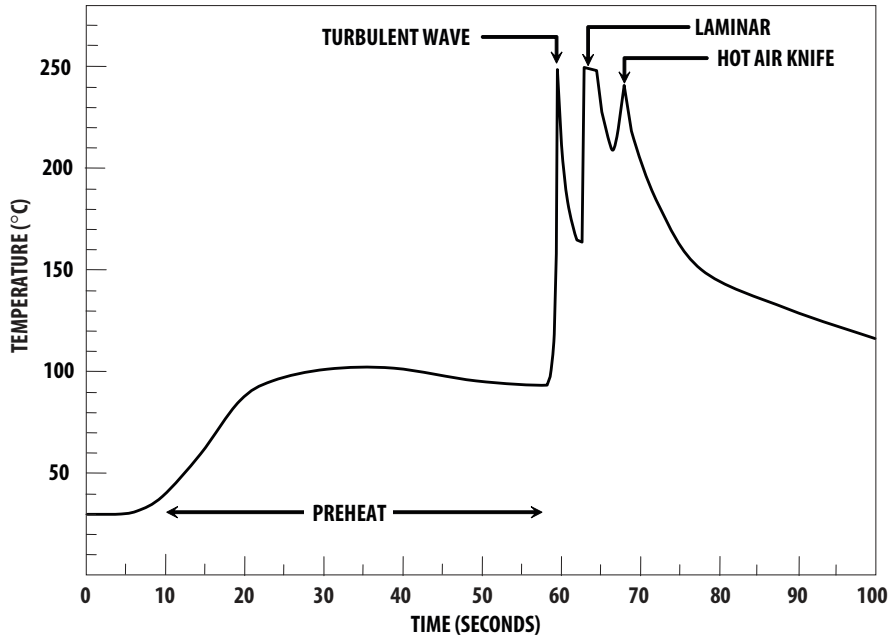

Recommended solder:  
Sn63 (Leaded solder alloy)  
SAC305 (Lead-free solder alloy)

Flux: Rosin flux



Solder bath temperature:  $245 \text{ }^\circ\text{C} \pm 5 \text{ }^\circ\text{C}$   
(maximum peak temperature =  $250 \text{ }^\circ\text{C}$ )

Dwell time: 1.5 sec – 3.0 sec  
(maximum = 3 sec)











Note: Allow for board to be sufficiently cooled to room temperature before you exert mechanical force.

## Packing Label

(i) Avago Mother Label: (Available on packaging box of ammo pack and shipping box)

	
(1P) Item: <b>Part Number</b> 	STANDARD LABEL LS0002 RoHS Compliant e3 max temp 250C
(1T) Lot: <b>Lot Number</b> 	(Q) QTY: <b>Quantity</b> 
LPN: 	CAT: <b>Intensity Bin</b> 
(9D)MFG Date: <b>Manufacturing Date</b> 	BIN: <b>Color Bin</b>
<hr/>	
(P) Customer Item: 	
(V) Vendor ID: 	(9D) Date Code: <b>Date Code</b> 
<hr/>	
DeptID: 	Made In: <b>Country of Origin</b> 

(ii) Avago Baby Label (Only available on bulk packaging)

	
<b>Lamps Baby Label</b>	
RoHS Compliant e3 max temp 250C	
(1P) PART #: <b>Part Number</b> 	
(1T) LOT #: <b>Lot Number</b> 	
(9D)MFG DATE: <b>Manufacturing Date</b> 	QUANTITY: <b>Packing Quantity</b> 
C/O: <b>Country of Origin</b>	
<hr/>	
Customer P/N: 	CAT: <b>Intensity Bin</b> 
Supplier Code: 	BIN: <b>Color Bin</b> 
	DATECODE: <b>Date Code</b> 

For product information and a complete list of distributors, please go to our web site: [www.avagotech.com](http://www.avagotech.com)

Avago, Avago Technologies, and the A logo are trademarks of Avago Technologies in the United States and other countries. Data subject to change. Copyright © 2005-2014 Avago Technologies. All rights reserved.  
AV02-1029EN - August 20, 2014

