

# XS218B4PAL2

Inductive proximity sensors XS, inductive sensor XS2 M18, L41mm, brass, Sn16mm, 12...24 VDC, cable 2 m



## Main

Range of Product	Telemecanique Inductive proximity sensors XS
Series name	General purpose
Sensor Type	Inductive proximity sensor
Device Application	Mobile equipment
Sensor name	XS2
Sensor design	Cylindrical M18
Size	41 mm
Body type	Fixed
Detector flush mounting acceptance	Non flush mountable
Material	Metal
Type of output signal	Discrete
Wiring Technique	3-wire
[Sn] nominal sensing distance	0.63 in (16 mm)
Discrete output function	1 NO
Output circuit type	DC
Discrete output type	PNP
Electrical connection	Cable
Cable length	6.56 ft (2 m)
[Us] rated supply voltage	12...24 V DC reverse polarity protection
Switching capacity in mA	<= 200 mA overload and short-circuit protection
IP degree of protection	IP65 conforming to IEC 60529 IP67 conforming to DIN 40050 IP69K

## Complementary

Thread type	M18 x 1
Detection face	Frontal
Front material	PPS
Enclosure Material	Nickel Plated Brass
Sensing range	> 0.59...1.57 in (> 15...40 mm)
Operating zone	0.00...0.50 in (0...12.8 mm)
Differential travel	1...15% of Sr
Cable composition	3 x 0.34 mm <sup>2</sup>
Wire insulation material	PvR
Status LED	Output state 1 LED yellow)
Supply voltage limits	10...36 V DC
Switching frequency	<= 1000 Hz
Maximum voltage drop	<2 V closed)
Current consumption	<= 10 mA no-load
Maximum delay first up	15 ms
Maximum delay response	0.3 ms
Maximum delay recovery	0.7 ms
Marking	CE

Threaded length	0.83 in (21 mm)
Length	1.61 in (41 mm)
Net Weight	0.23 lb(US) (0.105 kg)

## Environment

Product Certifications	CSA UL E2
Ambient air temperature for operation	-13...158 °F (-25...70 °C)
Ambient Air Temperature for Storage	-40...185 °F (-40...85 °C)
Vibration resistance	25 gn +/- 2 mm 10...55 Hz)IEC 60068-2-6
Shock resistance	50 gn 11 ms IEC 60068-2-27

## Ordering and shipping details

Category	22486 - SENSORS, PROXIMITY
Discount Schedule	DS2
GTIN	3389119037181
Nbr. of units in pkg.	1
Package weight(Lbs)	3.70 oz (105 g)
Returnability	No
Country of origin	ID

## Packing Units

Unit Type of Package 1	PCE
Package 1 Height	1.61 in (4.1 cm)
Package 1 width	5.20 in (13.2 cm)
Package 1 Length	3.82 in (9.7 cm)
Unit Type of Package 2	S02
Number of Units in Package 2	22
Package 2 Weight	6.10 lb(US) (2.765 kg)
Package 2 Height	5.91 in (15 cm)
Package 2 width	11.81 in (30 cm)
Package 2 Length	15.75 in (40 cm)
Unit Type of Package 3	PAL
Number of Units in Package 3	352
Package 3 Weight	81.48 lb(US) (36.96 kg)
Package 3 Height	23.62 in (60 cm)
Package 3 width	31.50 in (80 cm)
Package 3 Length	30.31 in (77 cm)

## Offer Sustainability

Sustainable offer status	Green Premium product
California proposition 65	WARNING: This product can expose you to chemicals including: Diisononyl phthalate (DINP), which is known to the State of California to cause cancer, and Di-isodecyl phthalate (DIDP), which is known to the State of California to cause birth defects or other reproductive harm. For more information go to <a href="http://www.P65Warnings.ca.gov">www.P65Warnings.ca.gov</a>
REACH Regulation	<a href="#">REACH Declaration</a>
EU RoHS Directive	Pro-active compliance (Product out of EU RoHS legal scope) <a href="#">EU RoHS Declaration</a>
Mercury free	Yes
RoHS exemption information	<a href="#">Yes</a>
Environmental Disclosure	<a href="#">Product Environmental Profile</a>
Circularity Profile	<a href="#">End Of Life Information</a>

Dimensions

Pre-cabled

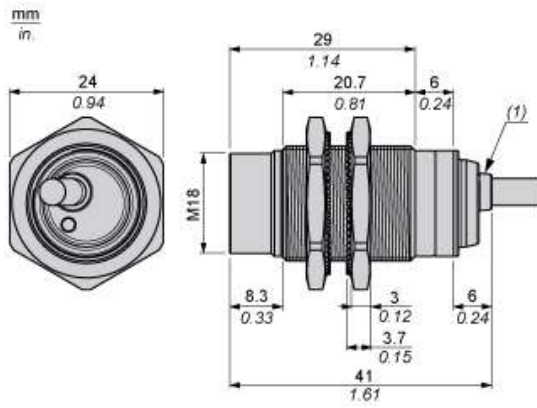

(1) Yellow LED (Output state indication)

Mounting and Clearance

Minimum Mounting Distances

Side by Side

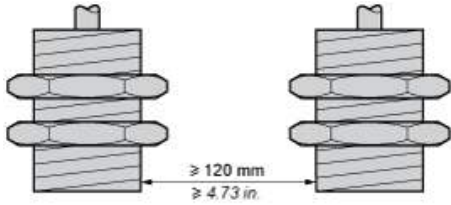

Face to Face

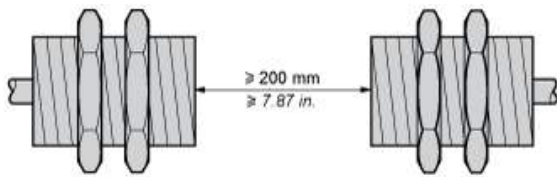

Facing a Metal Object

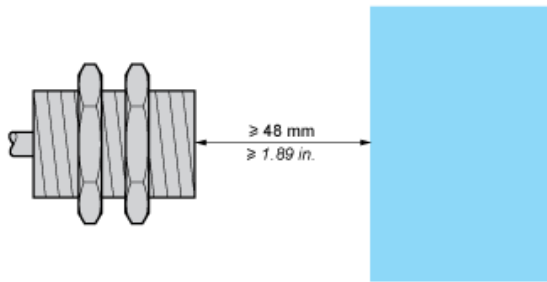

Mounted in a Metal Support

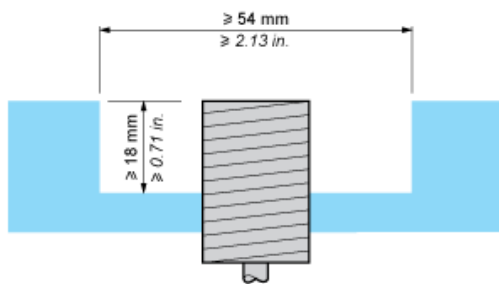

---

## Connection and Schema

---

### Wiring Schemes

PNP 3-wire

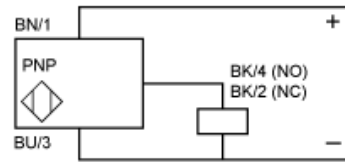

BN : Brown  
BK : Black  
BU : Blue

Performance Curves

Standard Steel Target: 24 x 24 x 1 mm

Operating zone: 0...12.8 mm

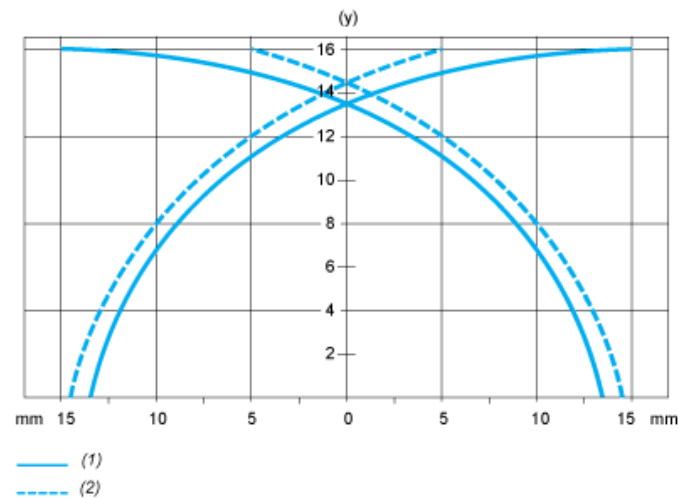

- (y) Sensing distance in mm
- (1) Pick-up points
- (2) Drop-out points (object approaching from the side)