

Description

Single and two pole magnetic circuit breakers with trip-free mechanism and push/pull on/off manual actuation. A choice of fast magnetic only or hydraulically delayed switching characteristics (S-type MO or HM CBE to EN 60934) ensures suitability for a wide range of applications. Convenient threadneck panel or plug-in mounting, and with a white push button indicator band showing clearly the tripped/off position. Available with auxiliary contacts (1 x N/O, 1 x N/C) for status signalling. Approved to CBE standard EN 60934 (IEC 60934).

Typical application

Control equipment, communications systems, power semiconductors.

Standard current ratings and typical internal resistance values

Current rating (A)	Internal resistance (Ω) per pole		
	-F4/-F5	-E1/H1/R1	-E2/H2/R2
0.02	583	2 896	2 660
0.05	94	531	542
0.08	35.6	202	199
0.1	22.9	129	127
0.15	9.89	57.3	55.7
0.2	5.02	30.5	30.5
0.3	2.44	13.9	13.7
0.5	0.789	4.50	4.42
0.75	0.392	2.19	1.82
1	0.246	1.10	1.08
1.25	0.145	0.695	0.686
1.5	0.10	0.487	0.472
1.75	0.083	0.355	0.337
2	0.059	0.295	0.291
2.5	0.048	0.174	0.168
3	0.028	0.121	0.118
4	< 0.02	0.0729	0.0687
5	< 0.02	0.0437	0.0449
6	< 0.02	0.0329	0.0323
8	< 0.02	< 0.02	< 0.02
10	< 0.02	< 0.02	< 0.02
12	< 0.02	< 0.02	< 0.02
15	< 0.02	< 0.02	< 0.02
16	< 0.02	< 0.02	< 0.02
20	< 0.02	< 0.02	< 0.02
25	< 0.02*	< 0.02	< 0.02
30	< 0.02*	< 0.02	< 0.02
40		< 0.02	
50		< 0.02	

* 50 % ON duty / 60 min.



1-pole

8340-G2...

2-pole

Technical data

For further details please see: http://www.e-t-a.de/ti_e

Voltage rating	3 AC 415 V; AC 240 V, 50/60 Hz; DC 80 V (higher DC voltages to special order)		
Current ratings	0.02...50 A DC 0.02...30 A AC		
Auxiliary circuit	1 A, AC 240 V/DC 65 V 0.5 A, DC 80 V		
Typical life	3 AC 415 V, AC 240 V: 0.02...30 A 6,000 operations at 1 x I _N , inductive 10,000 operations at 1 x I _N , resistive DC 80 V: 0.02...25 A 6,000 operations at 1 x I _N , inductive 0.02...30 A 10,000 operations at 1 x I _N , resistive 40 + 50 A 5,000 operations at 1 x I _N , resistive		
Ambient temperature	-40...+85 °C (-40...+185 °F)		
Insulation co-ordination (IEC 60664 and 60664A)	rated impulse withstand voltage 2.5 kV	pollution degree 2 reinforced insulation in operating area	
Dielectric strength (IEC 60664 and 60664A)	operating area test voltage AC 3,000 V Line to Load test voltage AC 1,500 V pole to pole (2- and 3-pole) test voltage AC 1,500 V main to auxiliary circuit test voltage AC 1,500 V switching to trip circuit test voltage AC 1,500 V (version -X)		
Insulation resistance	> 100 MΩ (DC 500 V)		
Interrupting capacity	6 x IN at AC; IEC 60934 - test sequence E4 x IN at DC		
Interrupting capacity (UL 1077)	I _N	0.02...20 A	25...30 A
	AC:	1-pole AC 250 V/3,500A	AC 250 V/3,500A
		2-pole AC 250 V/3,500A	AC 250 V/5,000A
	DC:	1-pole 0.02...50 A	DC 80 V/3,500 A
		2-pole 0.02...30 A	DC 80 V/3500 A
Degree of protection (IEC 60529/DIN 40050)	operating area IP40 terminal area IP00		
Vibration	with button down: 10 g (57-2000 Hz), ± 0.76 mm (10-57 Hz) at 0.9 x I _N other mounting planes: 10 g (57-2000 Hz) at I _N to IEC 60068-2-6, test Fc 10 frequency cycles/axis		
Shock	100 g (11 ms) at 1 x I _N , directions 1,2,3,4,5 100 g (11 ms) at 0.8 x I _N , direction 6 to IEC 60068-2-27, test Ea		
Corrosion	96 hours at 5 % salt mist, to IEC 60068-2-11, test Ka		
Humidity	240 hours at 95 % RH to IEC 60068-2-78, test Cab		
Mass	approx. 70 g per pole		

Ordering information

Type No.									
8340	Magnetic push/pull circuit breaker								
Mounting									
G	threadneck panel mounting								
Threadneck design									
2	M12x1								
Number of poles (main current paths)									
1	single pole, protected								
2	two pole, protected								
3	three pole, protected								
Panel hardware									
0	without panel hardware								
1	with hex nut M12x1 and washer 12/15								
Terminal design									
P1	blade terminals A6.3-0.8 mm (QC.250) (≤ 35 A)								
K4	screw terminals M5 recommended for $I_N > 20$ A								
R1	round connectors $\phi 6$								
Characteristic curve *)									
Characteristic curve, instantaneous:									
F4	DC								
F5	AC 50/60 Hz								
Short delay:									
E1	DC								
E2	AC 50/60 Hz								
Medium delay:									
H1	DC								
H2	AC 50/60 Hz								
Long delay:									
R1	DC								
R2	AC 50/60 Hz								
Actuator colour									
A	black with white trip indicator band								
Actuator marking									
4	rated current legible with location pin above (standard)								
7	rated current legible with location pin below								
Auxiliary contacts									
H0	without auxiliary contacts								
H1	with auxiliary contacts								
H2	with auxiliary contacts on pole 1 only (2 pole types)								
Auxiliary contact function									
1	one each N/O and N/C								
3	1 pair N/C (11/12)								
Auxiliary contact terminal design									
1	blade terminals A6.3-0.8 mm								
Current ratings (optional)									
0.02...50 A									

8340 - G 2 1 1 - P1 F4 - A 4 H1 1 1 - 8 A ordering example

Please be informed that we have minimum ordering quantities to be observed.

*) Other characteristic curves upon request (e.g. pulse delayed, for high inrush currents or capacitive loads)

Dimensions (1-pole)

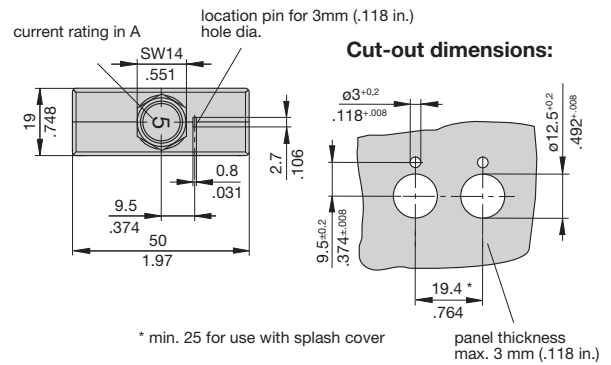
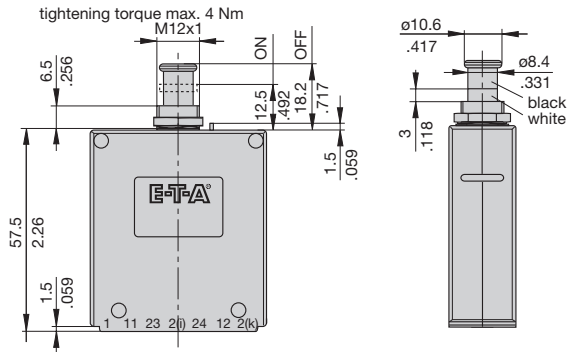

2-pole

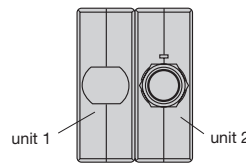
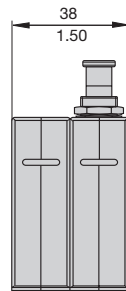

3-pole

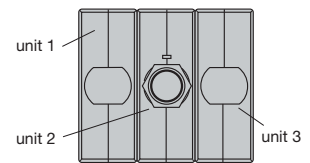
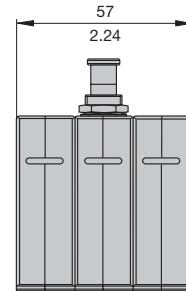

Cut-out dimensions:

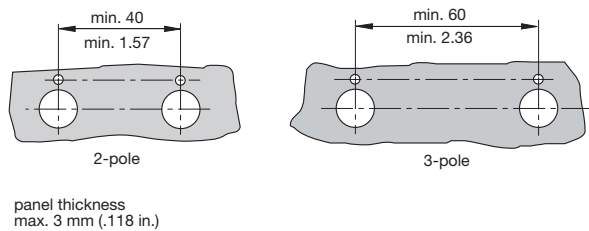

This is a metric design and millimeter dimensions take precedence (mm/inch)

Terminal design

Terminal design -P1

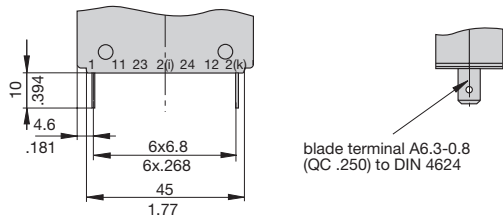

Terminal design -K4

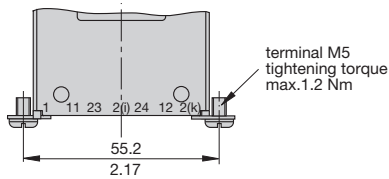

Terminal design -R1

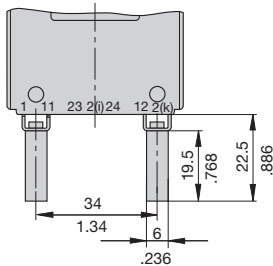

Auxiliary contact terminal design

1 N/O, 1 N/C

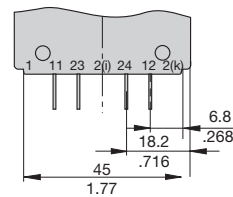

1 N/C

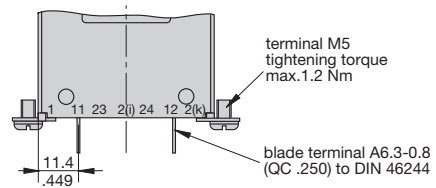

Internal connection diagrams

1-pole, protected magnetically

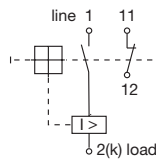

double pole

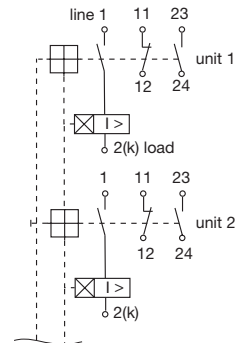

1-pole, protected hydraulic-magnetically

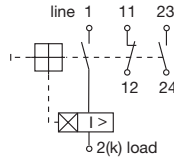

Installation drawings

Terminal design -P

Terminal design -K

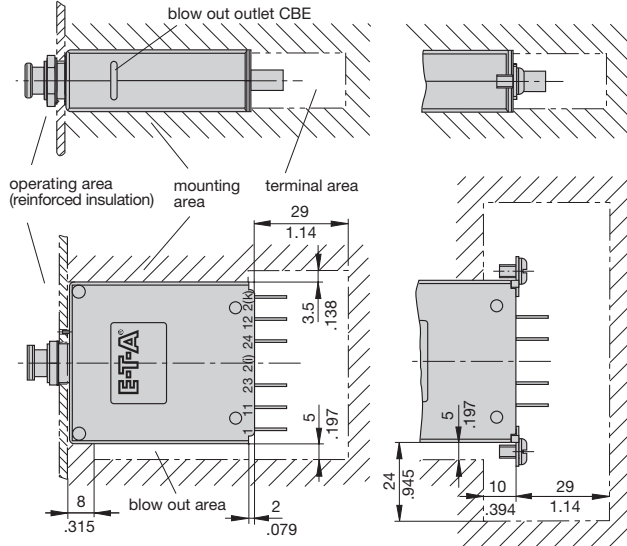

Terminal design -R

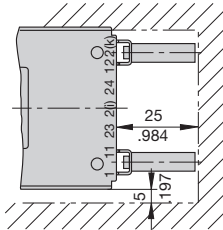

Approvals

Authority	Standard	Rated voltage	Current ratings
VDE	IEC / EN 60934	AC 240/415 V AC 240 V DC 80 V	0.02 A...30 A 0.02 A...30 A 0.02 A...50 A
UL	UL 1077	AC 250 V DC 80 V DC 80 V	0.02 A...30 A 0.02 A...50 A 100 A (2 poles in parallel)
UL	UL 489A	DC 80 V	0.05 A...30 A (1 + 2 pole)
CSA	C22.2 No 235	AC 250 V DC 80 V	0.02 A...30 A 0.02 A...50 A
CQC	GB 17701	AC 240/415 V AC 240 V DC 80 V DC 110 V	0.02 A...30 A 0.02 A...30 A 0.02 A...50 A 0.02 A...50 A (8340-G)
QPL Sweden Defence Material Admin.	MIL-C-55629	AC 240 V DC 50 V AC 240 V AC 240 / 415 V	1 A...30 A (8340-F410) 1 A...30 A (8340-410) 1 A...30 A (8340-F420) 1 A...30 A (8340-F430)

This is a metric design and millimeter dimensions take precedence (mm/inch)

Typical time/current characteristics

1

Curve F4 for DC, magnetic (instantaneous)

($I_N > 20$ A, 50% ON period, 60 min.) at +23 °C / +73.4 °F

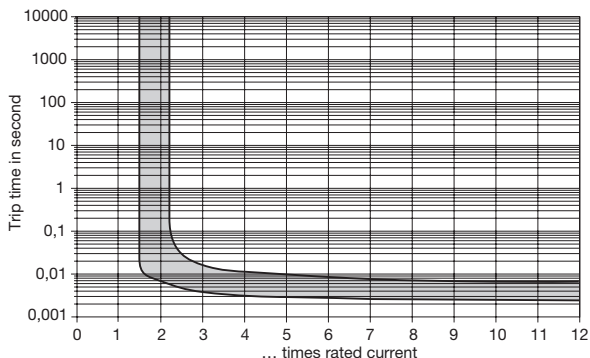

Curve F5 for AC 50/60 Hz (instantaneous)

($I_N > 20$ A, 50 % ED/60 min.)

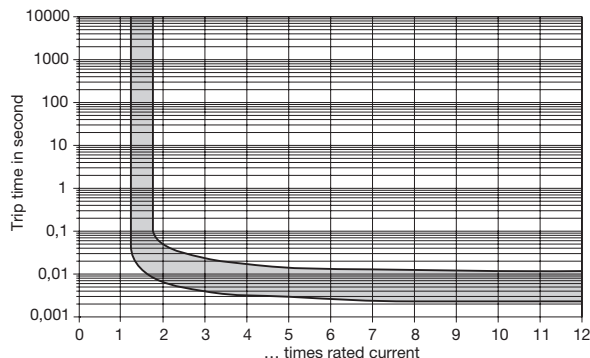

Curve E1 for DC (short delay)

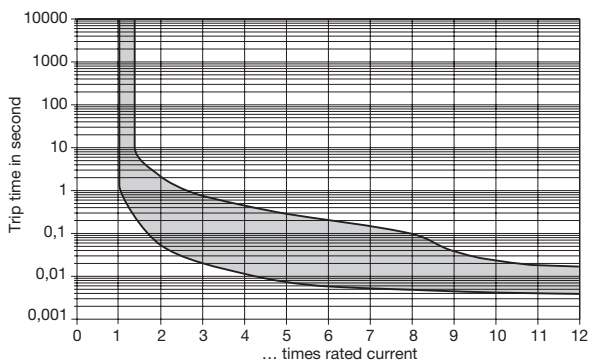

Curve E2 (short delay) for AC 50/60 Hz

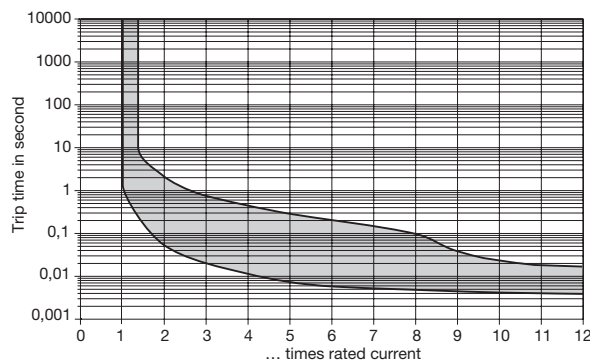

Curve H1 for DC (medium delay)

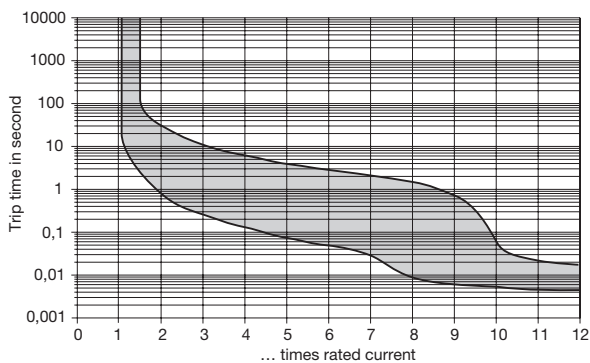

Curve H2 (medium delay) for AC 50/60 Hz

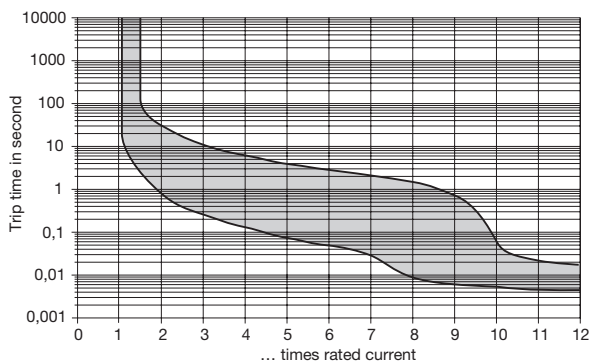

Curve R1 for DC (long delay)

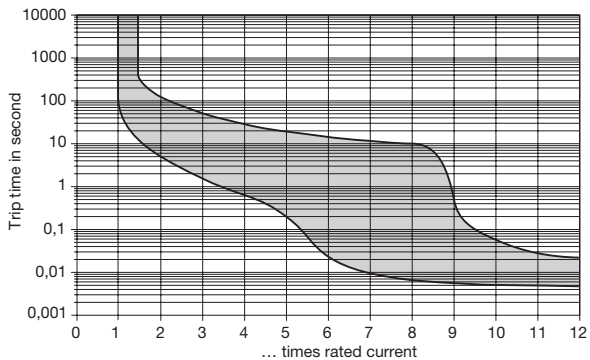

Curve R2 (long delay) for AC 50/60 Hz

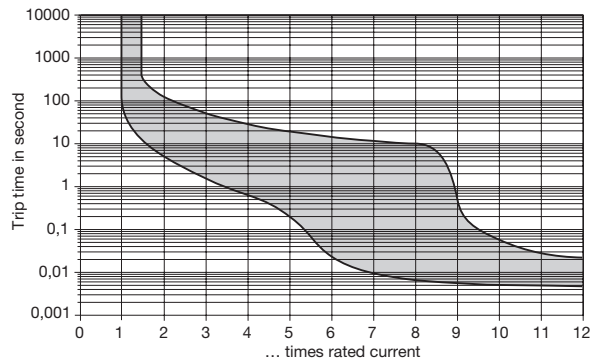

Accessories

Socket 18-P10-Si

(for ratings >16 A please contact E-T-A)

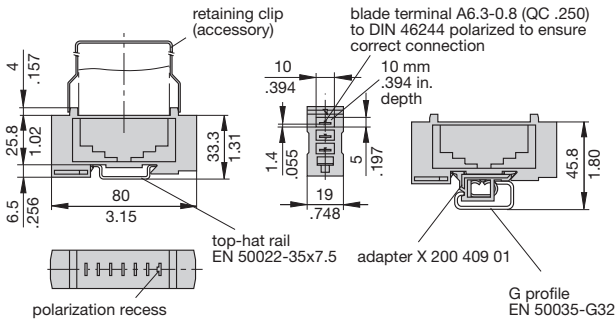

Polarized socket with adapter 18-P10-Si-20025

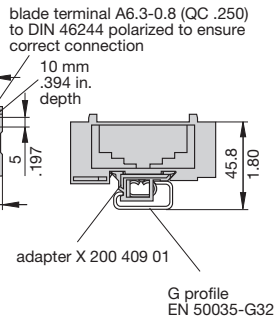

Bus bar (10-way) (supplied as a complete package) for type 18 socket
(for max. 100 A continuous load), more positions available on request
X 211 158 01 with terminal
X 211 158 02 without terminal

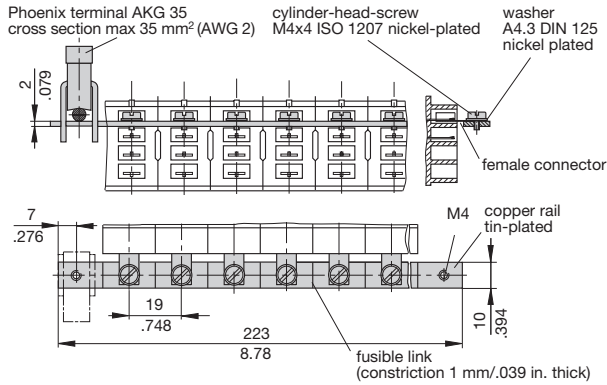

Insulated sleeving for bus bars Y 303 824 11

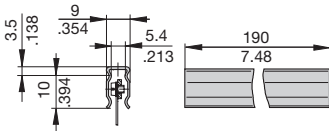

Retaining clip for socket 18-P10-Si Y 300 579 11

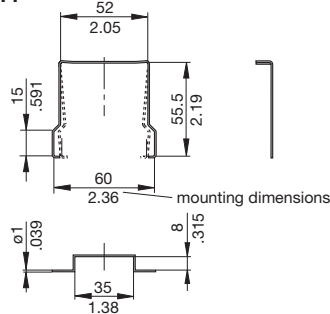

Connector bus link -P10

- X 210 588 01/1.5 mm² (AWG 16)**, brown (up to 13 A max. load)
- X 210 588 02/2.5 mm² (AWG 14)**, black (up to 20 A max. load)
- X 210 588 03/2.5 mm² (AWG 14)**, red (up to 20 A max. load)
- X 210 588 04/2.5 mm² (AWG 14)**, blue (up to 20 A max. load)

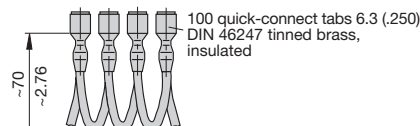

Hex nut Y 300 116 02

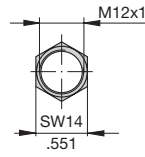

Spring washer Y 300 118 03

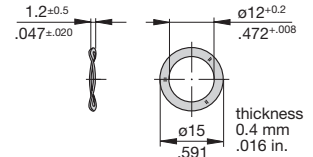

Accessories for push button

- Splash cover with hex nut and O ring (IP66 and IP67) X 200 801 08** (nickel plated hex nut M12x1, splash cover transparent)
- X 200 801 03** (black finish hex nut M12x1, splash cover black)

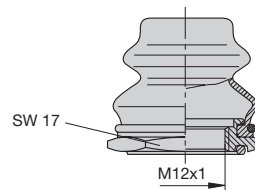

Splash seal, black, hex nut and O ring (IP54) X 200 802 01 (nickel plated hex nut M12x1, splash seal black)

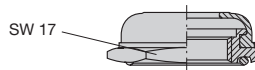

Actuator extension X 200 803 01 (black button)

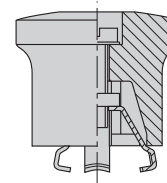

Shock directions / Mounting attitudes

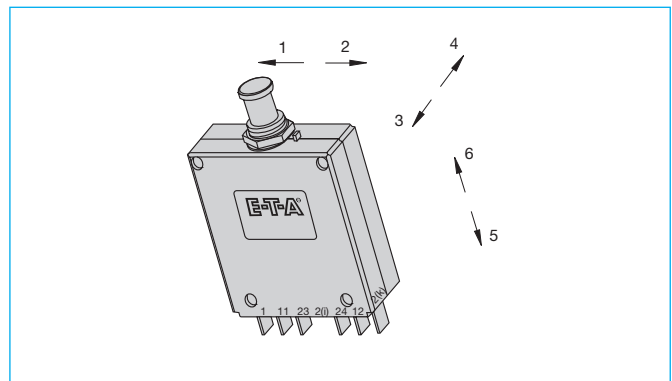

This is a metric design and millimeter dimensions take precedence ($\frac{\text{mm}}{\text{inch}}$)

All dimensions without tolerances are for reference only. In the interest of improved design, performance and cost effectiveness the right to make changes in these specifications without notice is reserved. Product markings may not be exactly as the ordering codes. Errors and omissions excepted.

