

---

**200 mA LDO Regulator with Alternative Dual-Voltage Level Output**

---

NO.EA-334-190610

**OUTLINE**

The RP155Z is a 200-mA LDO regulator with a selectable dual-voltage level output. It provides the VSEL pin that is used to select one of two preset output voltage levels.

Excellent ripple rejection, input transient response, and load transient response make the RP155Z ideal for the application for mobile communication equipment.

For protection, the RP155Z provides a short-current limiting circuit, a thermal shutdown circuit and an inrush current limiting circuit.

The RP155Z is offered in a 5-pin WLCSP-5-P1 package which achieves the smallest possible footprint solution on boards where area is limited.

**FEATURES**

- Input Voltage Range (Maximum Ratings) ..... 1.9 V to 5.25 V (6.0 V)
- Supply Current ..... Typ. 80  $\mu$ A
- Standby Current ..... Typ. 0.1  $\mu$ A
- Dropout Voltage ..... Typ. 0.085 V,  $I_{OUT} = 200$  mA,  $V_{SET} = 2.5$  V
- Ripple Rejection ..... Typ. 75 dB,  $f = 1$  kHz,  
Typ. 70 dB,  $f = 10$  kHz
- Output Voltage Accuracy .....  $\pm 1.0\%$
- Output Voltage Temperature Coefficient ..... Typ.  $\pm 30$  ppm/ $^{\circ}$ C
- Output Voltage Range ..... 1.6 V to 3.6 V
- Line Regulation ..... Typ. 0.02%/V
- Short-current Limiting ..... Typ. 50 mA
- Overcurrent Protection ..... Fold-back Type
- Thermal Shutdown ..... Typ. 165 $^{\circ}$ C
- Inrush Current Limiting ..... Typ. 160 mA during 180  $\mu$ s after start-up
- Ceramic Capacitor Compatible ..... 1.0  $\mu$ F or more
- Package ..... WLCSP-5-P1, 1.346 mm x 0.98 mm

**APPLICATIONS**

- Printers and PCs with SD Card Slots
- Battery-powered Equipment: Portable Music Players, IC Recorders, Cameras and Camcorders
- Portable Communication Equipment: Smartphones, Feature Phones
- Electronic Equipment System that Requires Two Levels of Output Voltage Regulation in Normal Mode/Power-Saving Mode

---

## RP155Z

---

NO.EA-334-190610

## SELECTION GUIDE

The set output voltage, the package type and the auto discharge function<sup>(1)</sup> are user-selectable options.

### Selection Guide

Product Name	Package	Quantity per Reel	Pb Free	Halogen Free
RP155Zxxx*-E2-F	WLCSP-5-P1	5,000 pcs	Yes	Yes

xxx: Specify a combination of two set output voltages ( $V_{SET1}/V_{SET2}$ ).

$V_{SET1}/V_{SET2}$  can be selected within the range of 1.6 V to 3.6 V.

\*: Specify the auto-discharge option.

B: Auto discharge function included

---

## BLOCK DIAGRAM

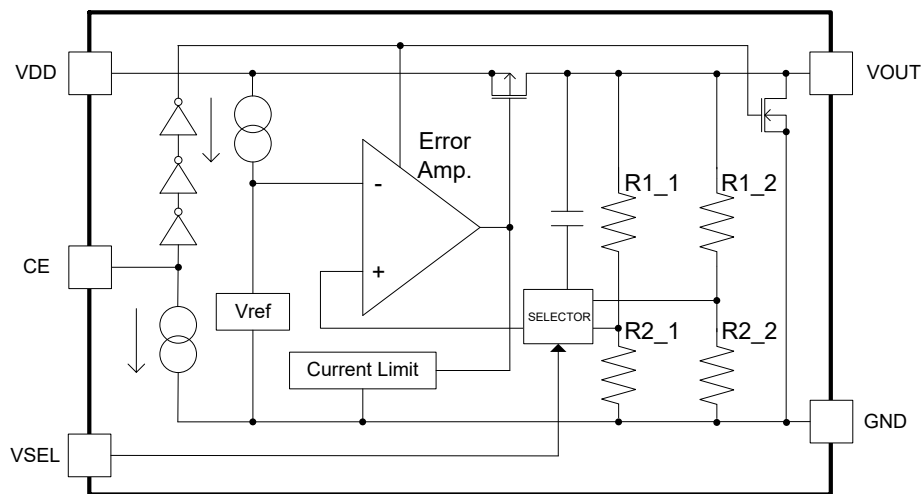

RP155Z Block Diagram

---

<sup>(1)</sup> Auto-discharge function quickly lowers the output voltage to 0 V, when the chip enable signal is switched from the active mode to the standby mode, by releasing the electrical charge accumulated in the external capacitor.

---

## PIN DESCRIPTIONS

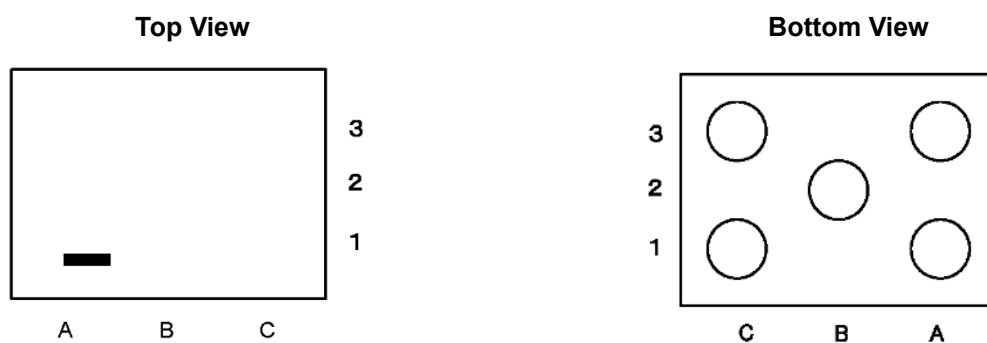

WLCSP-5-P1 Pin Configurations

### WLCSP-5-P1 Pin Descriptions

Pin No.	Symbol	Description
A1	CE	Chip Enable Pin, Active-high
A3	VSEL	Output Voltage Selector Pin, $V_{SET1}$ -low, $V_{SET2}$ -high
B2	GND	Ground Pin
C1	VOUT	Output Pin
C3	VDD	Input Pin

---

**RP155Z**

---

NO.EA-334-190610

**ABSOLUTE MAXIMUM RATINGS****Absolute Maximum Ratings**

Symbol	Item	Rating	Unit
V <sub>IN</sub>	Input Voltage	-0.3 to 6.0	V
V <sub>CE</sub>	CE Pin Input Voltage	-0.3 to 6.0	V
V <sub>SEL</sub>	VSEL Pin Input Voltage	-0.3 to 6.0	V
V <sub>OUT</sub>	VOUT Pin Output Voltage	-0.3 to V <sub>IN</sub> +0.3	V
I <sub>OUT</sub>	Output Current	510	mA
P <sub>D</sub>	Power Dissipation (JEDEC STD.51) <sup>(1)</sup>	550	mW
T <sub>j</sub>	Junction Temperature	-40 to 125	°C
T <sub>stg</sub>	Storage Temperature	-55 to 125	°C

**ABSOLUTE MAXIMUM RATINGS**

Electronic and mechanical stress momentarily exceeded absolute maximum ratings may cause permanent damage and may degrade the life time and safety for both device and system using the device in the field. The functional operation at or over these absolute maximum ratings is not assured.

**RECOMMENDED OPERATING CONDITIONS****Recommended Operating Conditions**

Symbol	Item	Rating	Unit
V <sub>IN</sub>	Input Voltage <sup>(2)</sup>	1.9 to 5.25	V
T <sub>a</sub>	Operating Temperature	-40 to 85	°C

**RECOMMENDED OPERATING CONDITIONS**

All of electronic equipment should be designed that the mounted semiconductor devices operate within the recommended operating conditions. The semiconductor devices cannot operate normally over the recommended operating conditions, even if they are used over such conditions by momentary electronic noise or surge. And the semiconductor devices may receive serious damage when they continue to operate over the recommended operating conditions.

---

<sup>(1)</sup> Refer to *POWER DISSIPATION* for detailed information.

<sup>(2)</sup> In case of operating the device beyond 5.25 V, do not exceed 5.5 V with 500 total operating hours.

---

## ELECTRICAL CHARACTERISTICS

$V_{IN} = V_{SET} + 1.0\text{ V}$ ,  $I_{OUT} = 1\text{ mA}$ ,  $C_{IN} = C_{OUT} = 1.0\text{ }\mu\text{F}$ ,  $V_{SEL} = \text{low/ high}$ , unless otherwise noted.

The specifications surrounded by   are guaranteed by design engineering at  $-40^{\circ}\text{C} \leq T_a \leq 85^{\circ}\text{C}$ .

### RP155Z Electrical Characteristics

( $T_a = 25^{\circ}\text{C}$ )

Symbol	Item	Conditions	Min.	Typ.	Max.	Unit
$V_{OUT}$	Output Voltage	$T_a = 25^{\circ}\text{C}$	x0.990		x1.010	V
		$-40^{\circ}\text{C} \leq T_a \leq 85^{\circ}\text{C}$	<span style="border: 1px solid black; padding: 0 2px;">x0.985</span>		<span style="border: 1px solid black; padding: 0 2px;">x1.015</span>	V
$I_{OUT}$	Output Current		<span style="border: 1px solid black; padding: 0 2px;">200</span>			mA
$\frac{\Delta V_{OUT}}{\Delta I_{OUT}}$	Load Regulation	$1\text{ mA} \leq I_{OUT} \leq 200\text{ mA}$		1	<span style="border: 1px solid black; padding: 0 2px;">10</span>	mV
$V_{DIF}$	Dropout Voltage	$I_{OUT} = 200\text{ mA}$	Refer to <i>Product-specific Electrical Characteristics</i>			
$I_{SS}$	Supply Current	$I_{OUT} = 0\text{ mA}$		80	<span style="border: 1px solid black; padding: 0 2px;">125</span>	$\mu\text{A}$
$I_{standby}$	Standby Current	$V_{CE} = 0\text{ V}$		0.1	1.0	$\mu\text{A}$
$\frac{\Delta V_{OUT}}{\Delta V_{IN}}$	Line Regulation	$V_{SET} + 0.5\text{ V} \leq V_{IN} \leq 5.25\text{ V}$		0.02	<span style="border: 1px solid black; padding: 0 2px;">0.10</span>	%/V
RR	Ripple Rejection	$f = 1\text{ kHz}$ , Ripple 0.2 Vp-p, $V_{IN} = V_{SET} + 1.0\text{ V}$ , $I_{OUT} = 30\text{ mA}$ ( $V_{OUT} \leq 2.0\text{ V}$ , $V_{IN} = 3.0\text{ V}$ )		75		dB
$\frac{\Delta V_{OUT}}{\Delta T_a}$	Output Voltage Temperature Coefficient	$-40^{\circ}\text{C} \leq T_a \leq 85^{\circ}\text{C}$		$\pm 30$		ppm/ $^{\circ}\text{C}$
$I_{SC}$	Short Current Limit	$V_{OUT} = 0\text{ V}$		50		mA
$I_{PD}$	CE Pull-down Current			0.3	<span style="border: 1px solid black; padding: 0 2px;">0.6</span>	$\mu\text{A}$
$V_{CEH}$	CE Input Voltage "H"		<span style="border: 1px solid black; padding: 0 2px;">1.0</span>			V
$V_{CEL}$	CE Input Voltage "L"				<span style="border: 1px solid black; padding: 0 2px;">0.4</span>	V
$V_{VSELH}$	VSEL Input Voltage "H"		<span style="border: 1px solid black; padding: 0 2px;">1.0</span>			V
$V_{VSELL}$	VSEL Input Voltage "L"				<span style="border: 1px solid black; padding: 0 2px;">0.4</span>	V
$T_{TSD}$	Thermal Shutdown Temperature	Junction Temperature		165		$^{\circ}\text{C}$
$T_{TSR}$	Thermal Shutdown Released Temperature	Junction Temperature		100		$^{\circ}\text{C}$
en	Output Noise	BW = 10 Hz to 100 kHz		$17 \times V_{SET} + 8$		$\mu\text{Vrms}$
$R_{LOW}$	Low Output Nch Tr. ON Resistance	$V_{IN} = 4.0\text{ V}$ , $V_{CE} = 0\text{ V}$		60		$\Omega$

All test items listed under *ELECTRICAL CHARACTERISTICS* are done under the pulse load condition ( $T_j \approx T_a = 25^{\circ}\text{C}$ ) except Output Voltage Temperature Coefficient, Output Noise and Ripple Rejection.

---

**RP155Z**

---

NO.EA-334-190610

**ELECTRICAL CHARACTERISTICS (continued)** $V_{IN} = V_{SET} + 1.0 \text{ V}$ ,  $I_{OUT} = 1 \text{ mA}$ ,  $C_{IN} = C_{OUT} = 1.0 \mu\text{F}$ ,  $V_{SEL} = \text{low/high}$ , unless otherwise noted.The specifications surrounded by   are guaranteed by design engineering at  $-40^\circ\text{C} \leq T_a \leq 85^\circ\text{C}$ .**RP155Z Product-specific Electrical Characteristics**

(Ta = 25°C)

Product Name	V <sub>SET1</sub> / V <sub>SET2</sub>	V <sub>OUT</sub> [V]						V <sub>DIF</sub> [V]	
		Ta = 25°C			-40°C ≤ Ta ≤ 85°C			Typ.	Max.
		Min.	Typ.	Max.	Min.	Typ.	Max.		
RP155Z001B	V <sub>SET1</sub>	1.782	1.800	1.818	<span style="border: 1px solid black; padding: 0 2px;">1.773</span>	1.800	<span style="border: 1px solid black; padding: 0 2px;">1.827</span>	0.100	<span style="border: 1px solid black; padding: 0 2px;">0.138</span>
	V <sub>SET2</sub>	2.822	2.850	2.878	<span style="border: 1px solid black; padding: 0 2px;">2.808</span>	2.850	<span style="border: 1px solid black; padding: 0 2px;">2.892</span>	0.085	<span style="border: 1px solid black; padding: 0 2px;">0.117</span>
RP155Z003B	V <sub>SET1</sub>	1.584	1.600	1.616	<span style="border: 1px solid black; padding: 0 2px;">1.576</span>	1.600	<span style="border: 1px solid black; padding: 0 2px;">1.624</span>	-( <sup>1</sup> )	- <sup>1</sup>
	V <sub>SET2</sub>	3.564	3.600	3.636	<span style="border: 1px solid black; padding: 0 2px;">3.546</span>	3.600	<span style="border: 1px solid black; padding: 0 2px;">3.654</span>	0.071	<span style="border: 1px solid black; padding: 0 2px;">0.105</span>
RP155Z004B	V <sub>SET1</sub>	1.782	1.800	1.818	<span style="border: 1px solid black; padding: 0 2px;">1.773</span>	1.800	<span style="border: 1px solid black; padding: 0 2px;">1.827</span>	0.100	<span style="border: 1px solid black; padding: 0 2px;">0.138</span>
	V <sub>SET2</sub>	3.267	3.300	3.333	<span style="border: 1px solid black; padding: 0 2px;">3.251</span>	3.300	<span style="border: 1px solid black; padding: 0 2px;">3.349</span>	0.071	<span style="border: 1px solid black; padding: 0 2px;">0.105</span>
RP155Z005B	V <sub>SET1</sub>	3.267	3.300	3.333	<span style="border: 1px solid black; padding: 0 2px;">3.251</span>	3.300	<span style="border: 1px solid black; padding: 0 2px;">3.349</span>	0.071	<span style="border: 1px solid black; padding: 0 2px;">0.105</span>
	V <sub>SET2</sub>	1.782	1.800	1.818	<span style="border: 1px solid black; padding: 0 2px;">1.773</span>	1.800	<span style="border: 1px solid black; padding: 0 2px;">1.827</span>	0.100	<span style="border: 1px solid black; padding: 0 2px;">0.138</span>
RP155Z006B	V <sub>SET1</sub>	2.871	2.900	2.929	<span style="border: 1px solid black; padding: 0 2px;">2.857</span>	2.900	<span style="border: 1px solid black; padding: 0 2px;">2.943</span>	0.085	<span style="border: 1px solid black; padding: 0 2px;">0.117</span>
	V <sub>SET2</sub>	1.782	1.800	1.818	<span style="border: 1px solid black; padding: 0 2px;">1.773</span>	1.800	<span style="border: 1px solid black; padding: 0 2px;">1.827</span>	0.100	<span style="border: 1px solid black; padding: 0 2px;">0.138</span>

---

<sup>(1)</sup> The input voltage should be equal or more than the minimum operating voltage (1.9 V).

---

## TYPICAL APPLICATION

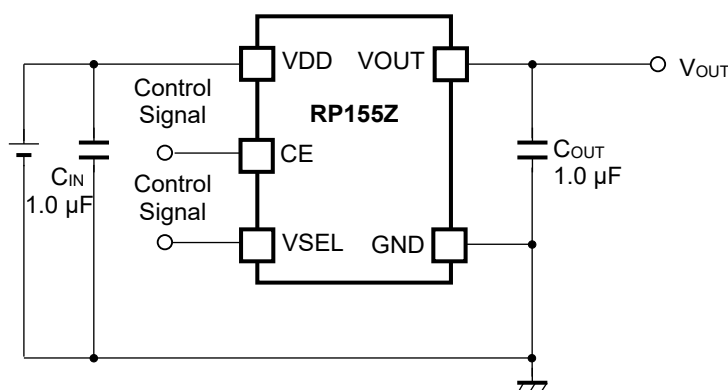

RP155Z Typical Application Circuit

### Technical Notes on the External Components

- Ensure the VDD and GND lines are sufficiently robust. If their impedances are too high, noise pickup or unstable operation may result. Connect a 1.0  $\mu\text{F}$  or more input capacitor ( $C_{\text{IN}}$ ) between the VDD and GND pins with shortest-distance wiring. Using ceramic capacitors (voltage rating of 6.3 V or more) with small Equivalent Series Resistance (ESR), Equivalent Series Inductance (ESL) and temperature dependence, such as X7R and X5R are recommended.
- In this device, phase compensation is provided to secure stable operation even when the load current is varied. For this purpose, connect a 1.0  $\mu\text{F}$  or more output capacitor ( $C_{\text{OUT}}$ ) between the VOUT and GND pins with shortest-distance wiring. In addition, as capacitance of a ceramic capacitor depends on temperature, DC bias and a package size, select capacitors with attention to influence by them bearing in mind the effective capacitance indicated below.

Set Output Voltage ( $V_{\text{SET}}$ )	Effective Capacitance
$1.6 \text{ V} \leq V_{\text{SET}} < 2.1 \text{ V}$	0.75 $\mu\text{F}$ or more
$2.1 \text{ V} \leq V_{\text{SET}} < 2.6 \text{ V}$	0.70 $\mu\text{F}$ or more
$2.6 \text{ V} \leq V_{\text{SET}} < 3.2 \text{ V}$	0.65 $\mu\text{F}$ or more
$3.2 \text{ V} \leq V_{\text{SET}} \leq 3.6 \text{ V}$	0.60 $\mu\text{F}$ or more

Using tantalum capacitors with large ESR may cause unstable output. Fully evaluate characteristics including frequency to ensure stable output.

**TYPICAL CHARACTERISTICS**

Note: Typical Characteristics are intended to be used as reference data, they are not guaranteed.

1) Output Voltage vs. Output Current ( $C_{IN}$  = Ceramic 1.0  $\mu$ F,  $C_{OUT}$  = Ceramic 1.0  $\mu$ F,  $T_a$  = 25°C)  
 1.6 V ( $V_{SET1}/V_{SET2}$ ) 1.8 V ( $V_{SET1}/V_{SET2}$ )

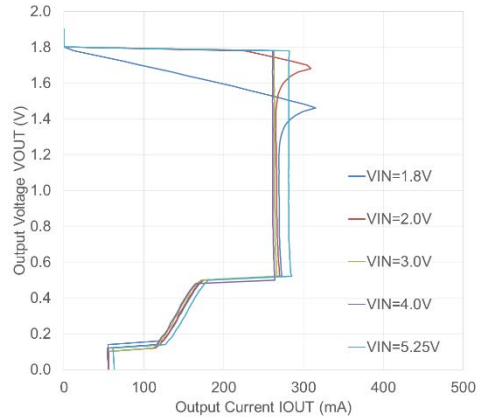
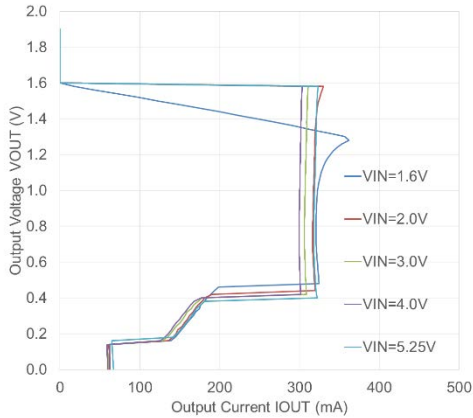

2.85 V ( $V_{SET1}/V_{SET2}$ )

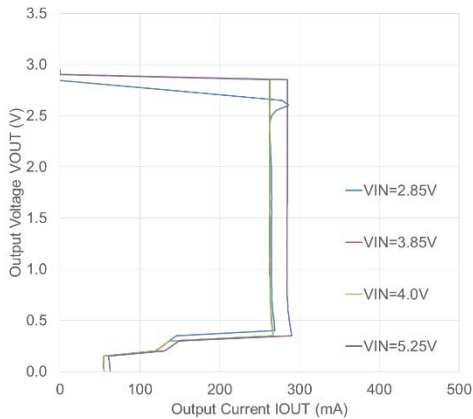

3.6 V ( $V_{SET1}/V_{SET2}$ )

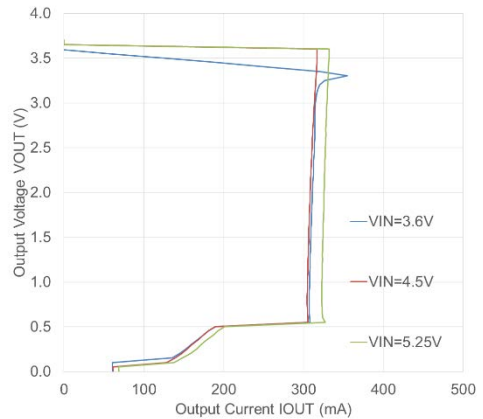

2) Output Voltage vs. Input Voltage ( $C_{IN}$  = Ceramic 1.0  $\mu$ F,  $C_{OUT}$  = Ceramic 1.0  $\mu$ F,  $T_a$  = 25°C)  
 1.6 V ( $V_{SET1}/V_{SET2}$ ) 1.8 V ( $V_{SET1}/V_{SET2}$ )

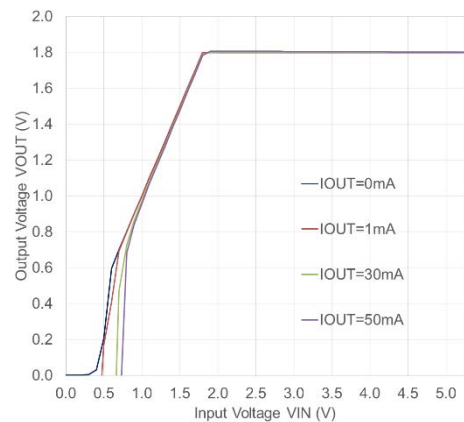
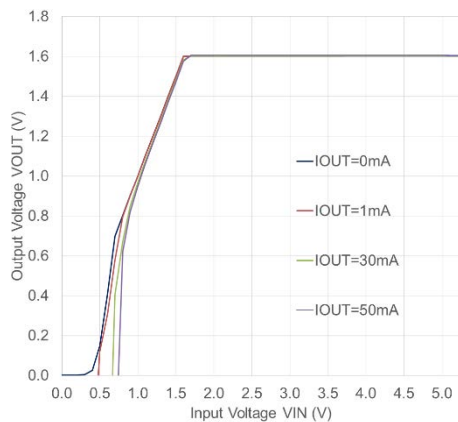



2.85 V ( $V_{SET1}/V_{SET2}$ )

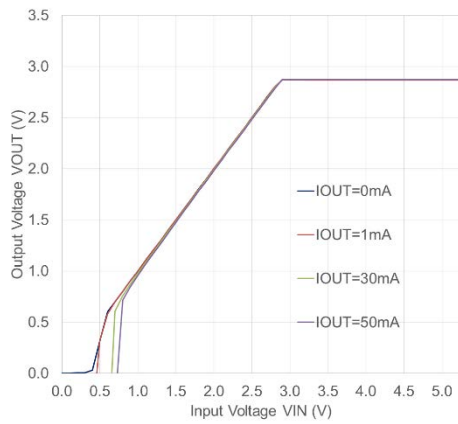

3.6 V ( $V_{SET1}/V_{SET2}$ )

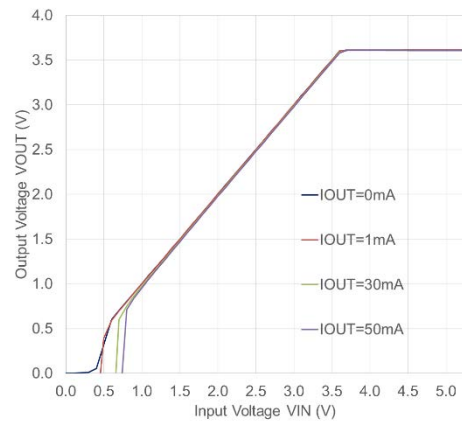

3) Supply Current vs. Input Voltage ( $C_{IN}$  = Ceramic 1.0  $\mu$ F,  $C_{OUT}$  = Ceramic 1.0  $\mu$ F,  $T_a$  = 25°C)

1.6 V ( $V_{SET1}/V_{SET2}$ )

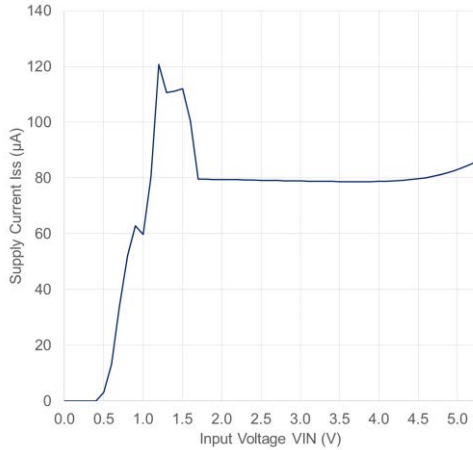

1.8 V ( $V_{SET1}/V_{SET2}$ )

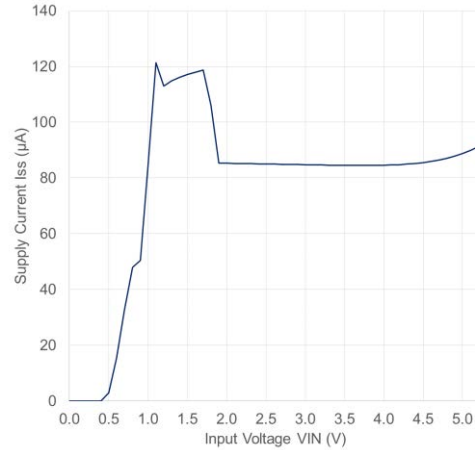

2.85 V ( $V_{SET1}/V_{SET2}$ )

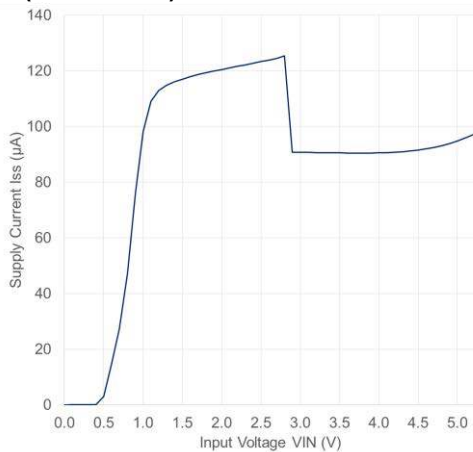

3.6 V ( $V_{SET1}/V_{SET2}$ )

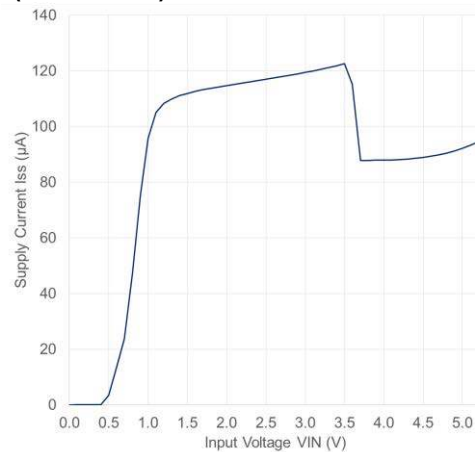

**4) Output Voltage vs. Temperature ( $C_{IN}$  = Ceramic 1.0  $\mu$ F,  $C_{OUT}$  = Ceramic 1.0  $\mu$ F)**

**1.6 V ( $V_{SET1}/ V_{SET2}$ )**  
 $V_{IN} = 2.6$  V,  $I_{OUT} = 1$  mA

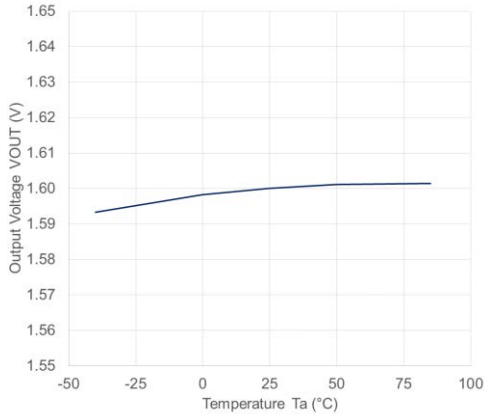

**1.8 V ( $V_{SET1}/ V_{SET2}$ )**  
 $V_{IN} = 2.8$  V,  $I_{OUT} = 1$  mA

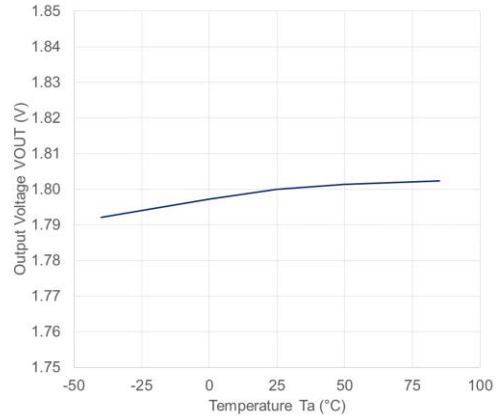

**2.85 V ( $V_{SET1}/ V_{SET2}$ )**  
 $V_{IN} = 3.85$  V,  $I_{OUT} = 1$  mA

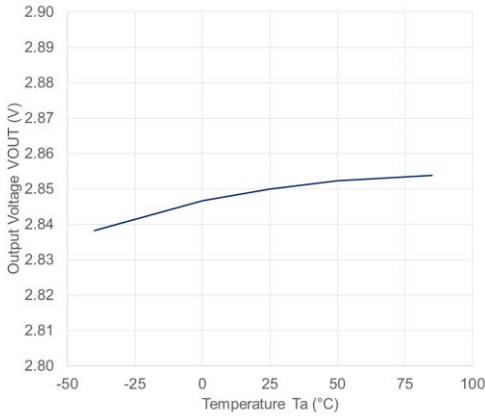

**3.6 V ( $V_{SET1}/ V_{SET2}$ )**  
 $V_{IN} = 4.6$  V,  $I_{OUT} = 1$  mA

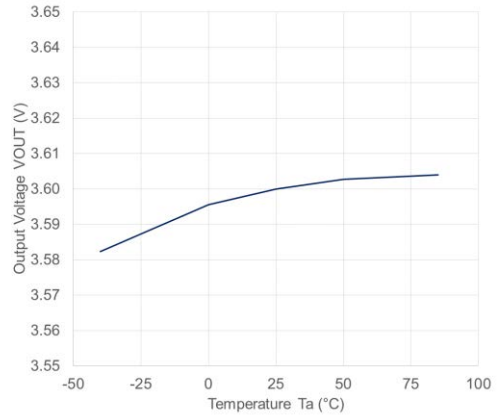

**5) Supply Current vs. Temperature**

**1.6 V ( $V_{SET1}/ V_{SET2}$ )**  
 $V_{IN} = 2.6$  V,  $I_{OUT} = 0$  mA

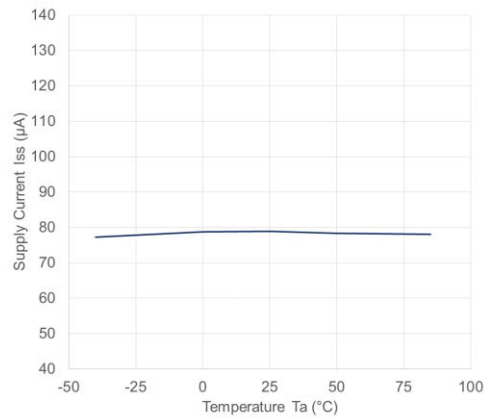

**1.8 V ( $V_{SET1}/ V_{SET2}$ )**  
 $V_{IN} = 2.8$  V,  $I_{OUT} = 0$  mA

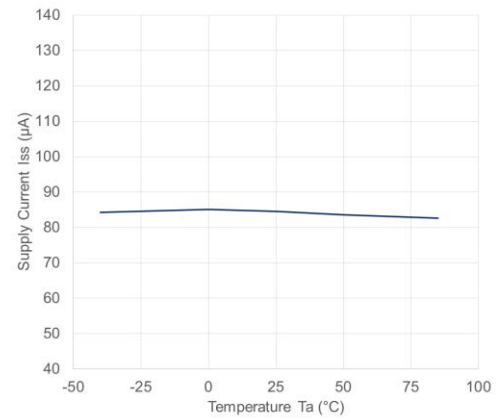

**2.85 V ( $V_{SET1}/V_{SET2}$ )**  
 $V_{IN} = 3.85\text{ V}, I_{OUT} = 0\text{ mA}$

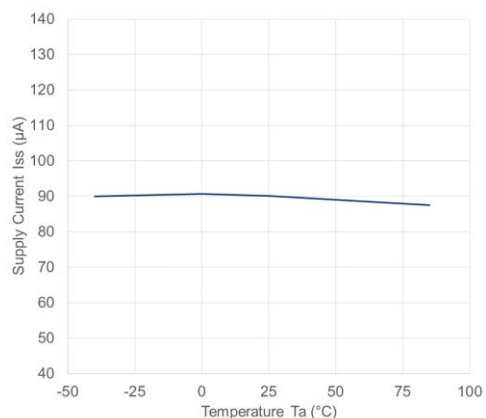

**3.6 V ( $V_{SET1}/V_{SET2}$ )**  
 $V_{IN} = 4.6\text{ V}, I_{OUT} = 0\text{ mA}$

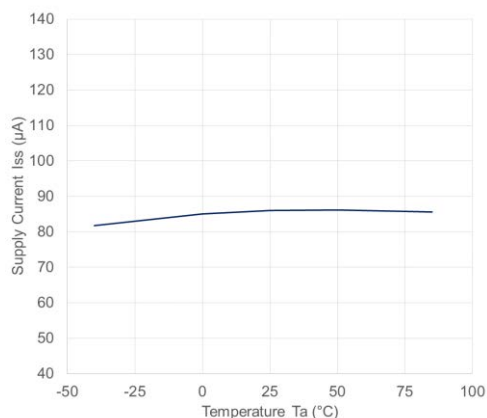

**6) Dropout Voltage vs. Output Current ( $C_{IN} = \text{Ceramic } 1.0\text{ }\mu\text{F}, C_{OUT} = \text{Ceramic } 1.0\text{ }\mu\text{F}$ )**

**1.6 V ( $V_{SET1}/V_{SET2}$ )**

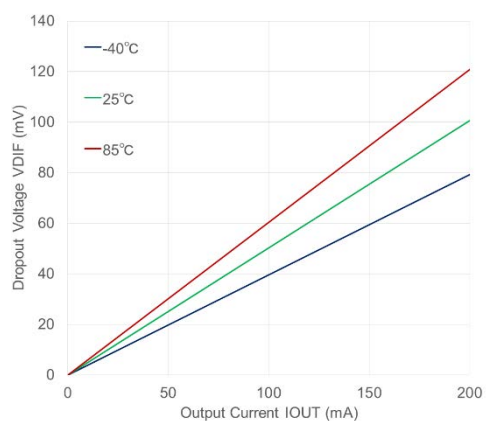

**1.8 V ( $V_{SET1}/V_{SET2}$ )**

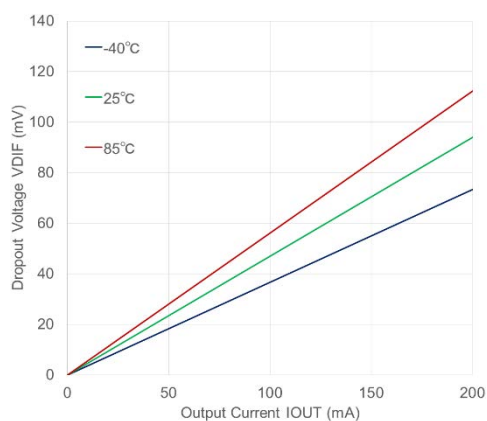

**2.85 V ( $V_{SET1}/V_{SET2}$ )**

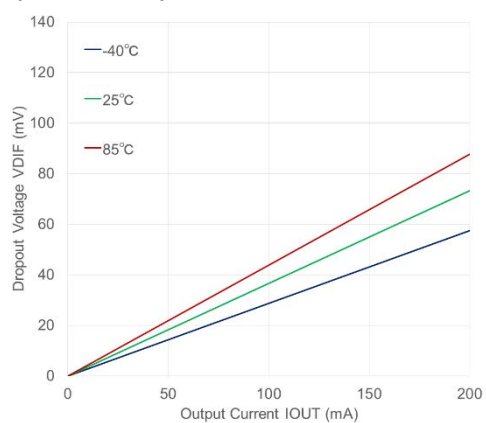

**3.6 V ( $V_{SET1}/V_{SET2}$ )**

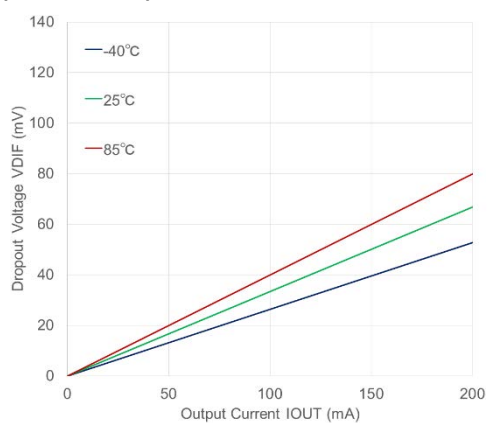

**7) Dropout Voltage vs. VR\_VSET (C<sub>IN</sub> = Ceramic 1.0 µF, C<sub>OUT</sub> = Ceramic 1.0 µF, Ta = 25°C)  
V<sub>SET1</sub>/ V<sub>SET2</sub>**

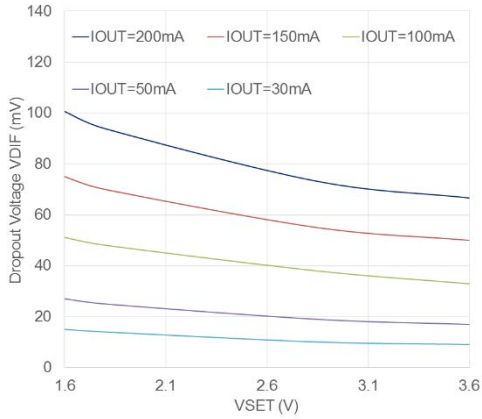

**8) Dropout Voltage vs. Temperature (C<sub>IN</sub> = Ceramic 1.0 µF, C<sub>OUT</sub> = Ceramic 1.0 µF)  
1.6 V (V<sub>SET1</sub>/ V<sub>SET2</sub>)**

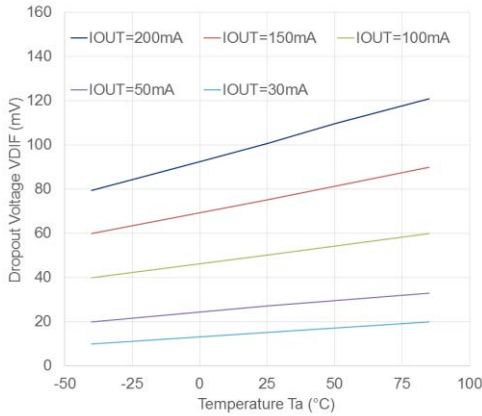

**1.8 V (V<sub>SET1</sub>/ V<sub>SET2</sub>)**

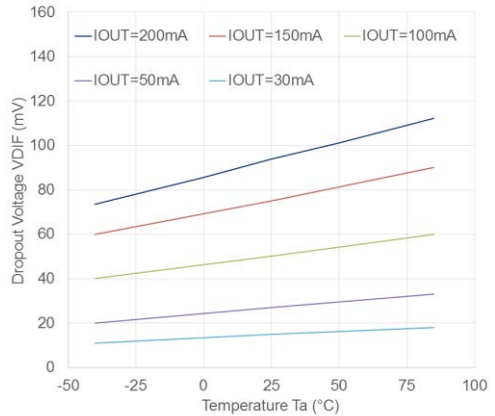

**2.85 V (V<sub>SET1</sub>/ V<sub>SET2</sub>)**

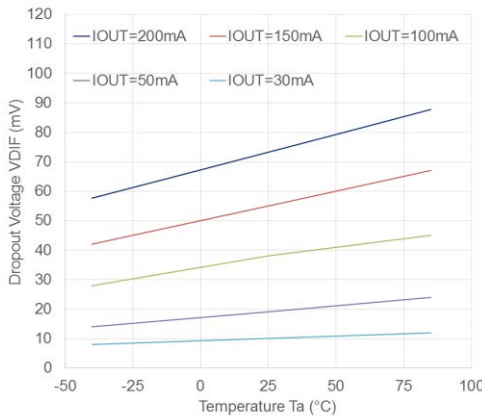

**3.6 V (V<sub>SET1</sub>/ V<sub>SET2</sub>)**

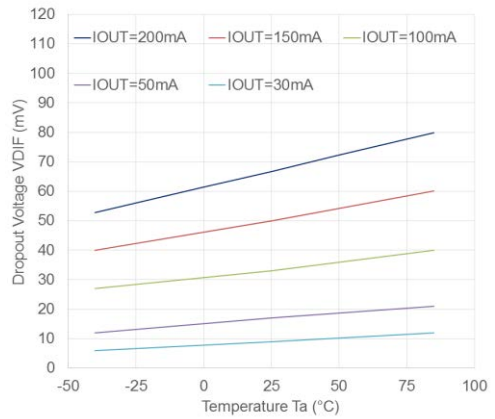

9) Ripple Rejection vs. Input Bias ( $C_{IN}$  = none,  $C_{OUT}$  = Ceramic 1.0  $\mu$ F, Input Ripple = 0.2 Vp-p,  $T_a$  = 25°C)

1.6 V ( $V_{SET1}/V_{SET2}$ )

$I_{OUT} = 1$  mA

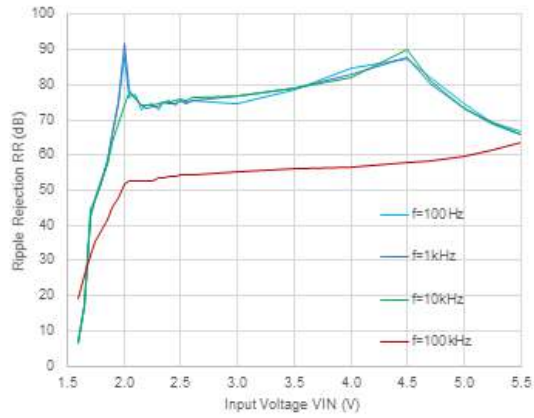

$I_{OUT} = 30$  mA

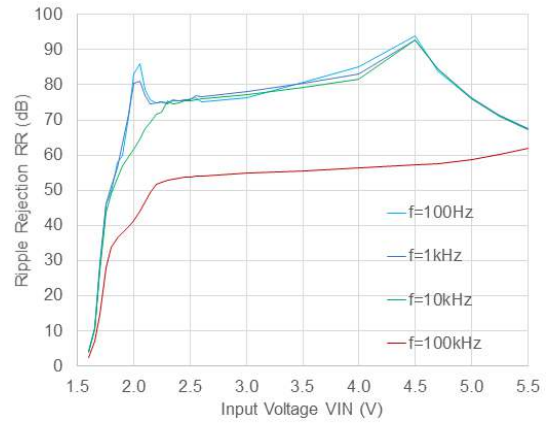

1.8 V ( $V_{SET1}/V_{SET2}$ )

$I_{OUT} = 1$  mA

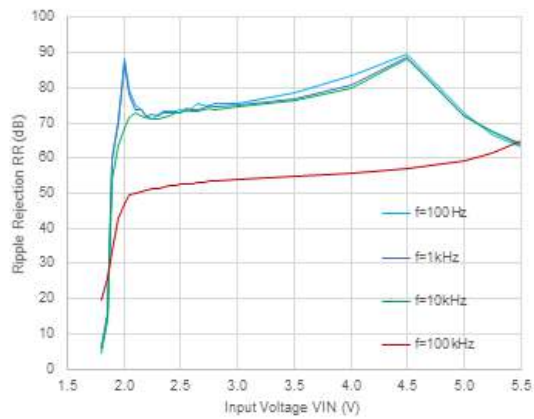

$I_{OUT} = 30$  mA

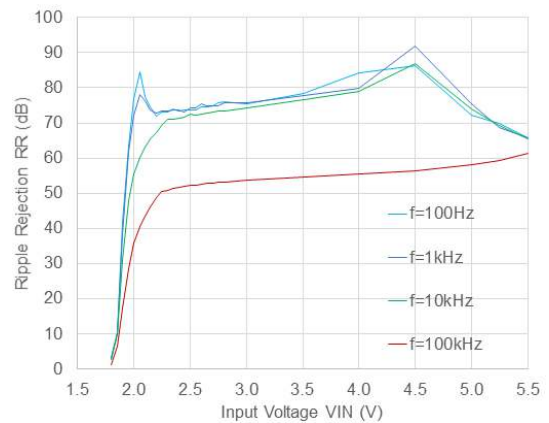

2.85 V ( $V_{SET1}/V_{SET2}$ )

$I_{OUT} = 1$  mA

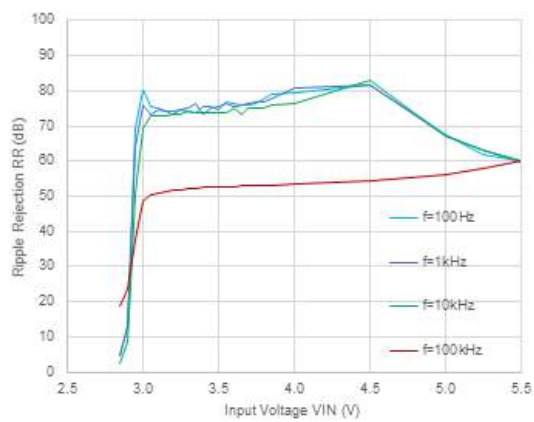

$I_{OUT} = 30$  mA

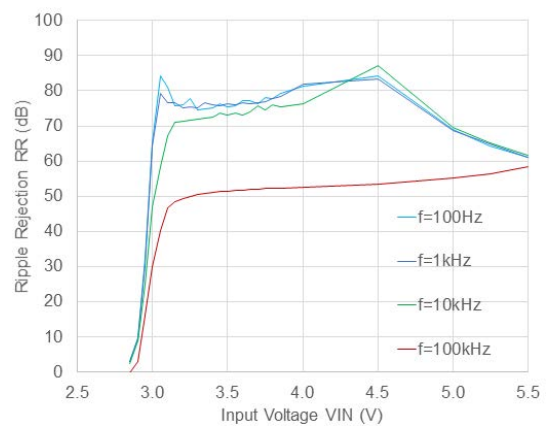

# RP155Z

NO.EA-334-190610

**3.6 V ( $V_{SET1}/V_{SET2}$ )**  
 **$I_{OUT} = 1\text{ mA}$**

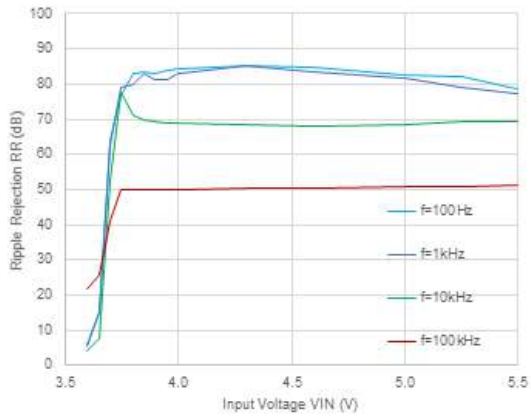

**$I_{OUT} = 30\text{ mA}$**

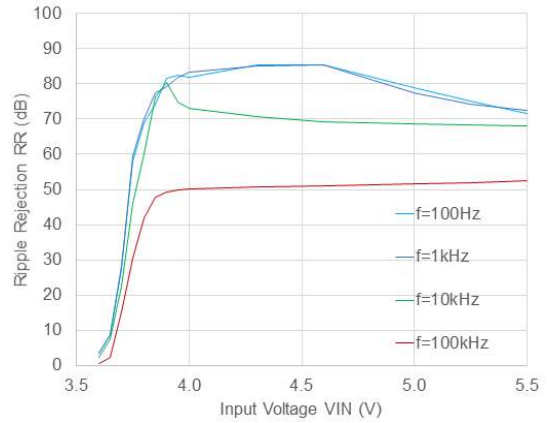

**10) Ripple Rejection vs. Frequency ( $C_{IN} = \text{none}$ ,  $C_{OUT} = \text{Ceramic } 1.0\ \mu\text{F}$ , Input Ripple =  $0.2\text{ Vp-p}$ ,  $T_a = 25^\circ\text{C}$ )**

**1.6 V ( $V_{SET1}/V_{SET2}$ ),  $V_{IN} = 2.6\text{ V}$**

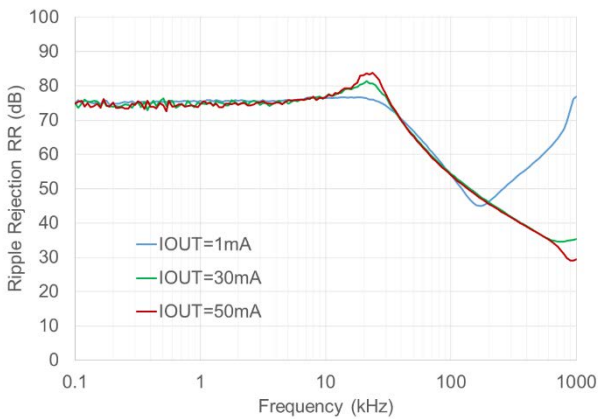

**1.8 V ( $V_{SET1}/V_{SET2}$ ),  $V_{IN} = 2.8\text{ V}$**

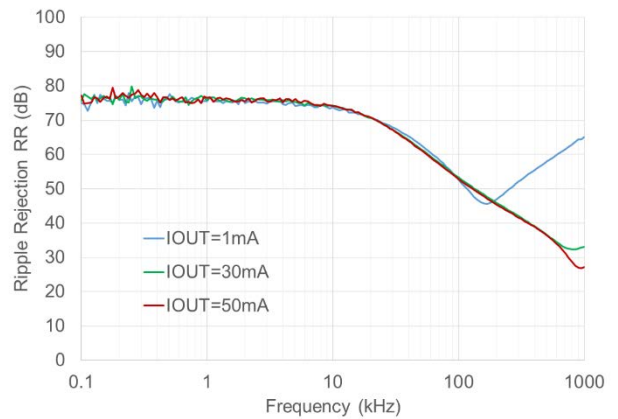

**2.85 V ( $V_{SET1}/V_{SET2}$ ),  $V_{IN} = 3.85\text{ V}$**

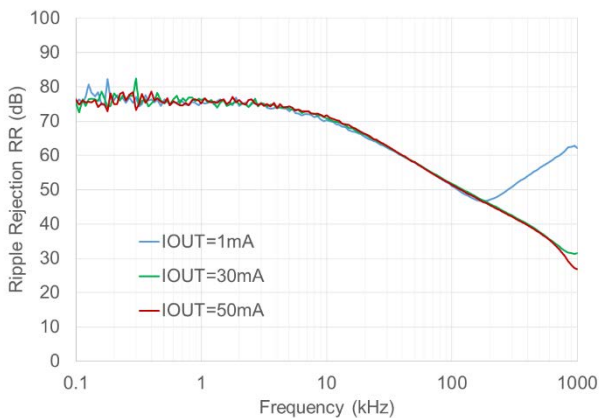

**3.6 V ( $V_{SET1}/V_{SET2}$ ),  $V_{IN} = 4.6\text{ V}$**

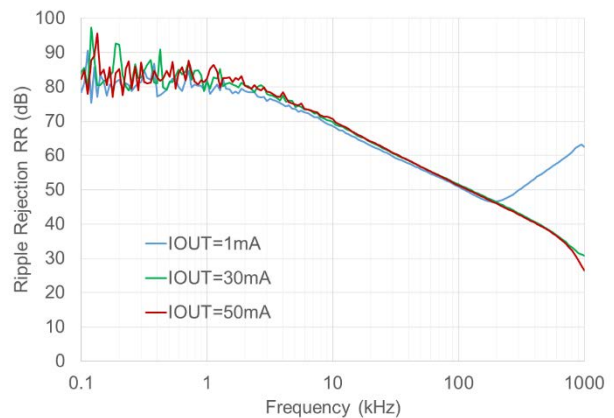

**11) Input Transient Response ( $C_{IN}$  = none,  $C_{OUT}$  = Ceramic 1.0  $\mu$ F,  $I_{OUT}$  = 30 mA,  $t_r$  =  $t_f$  = 5  $\mu$ s,  $T_a$  = 25°C)**

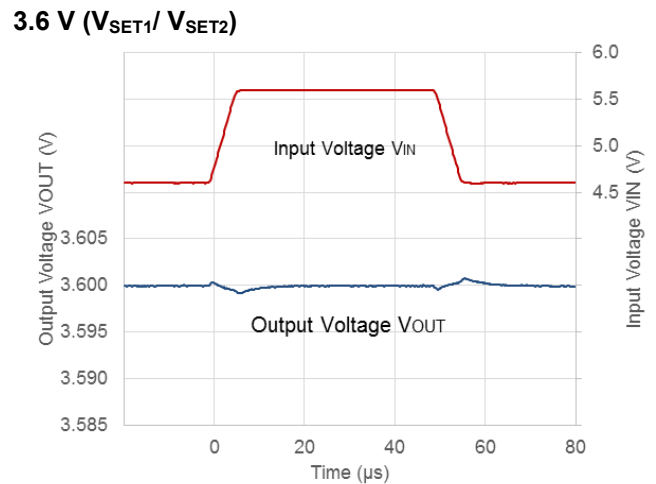
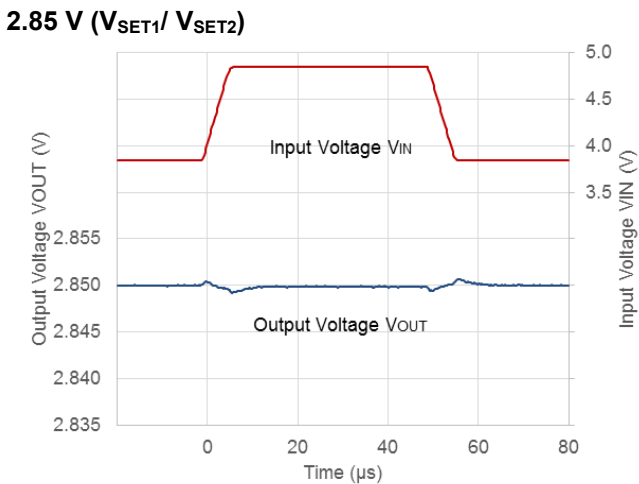
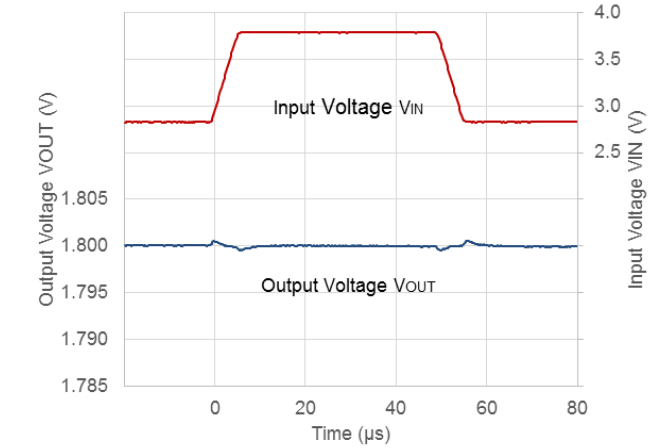
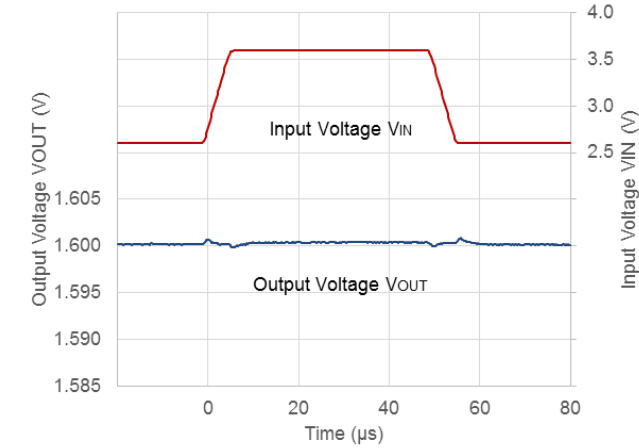

**12) Load Transient Response ( $C_{IN}$  = Ceramic 1.0  $\mu$ F,  $C_{OUT}$  = Ceramic 1.0  $\mu$ F,  $t_r$  =  $t_f$  = 0.5  $\mu$ s,  $T_a$  = 25°C)**

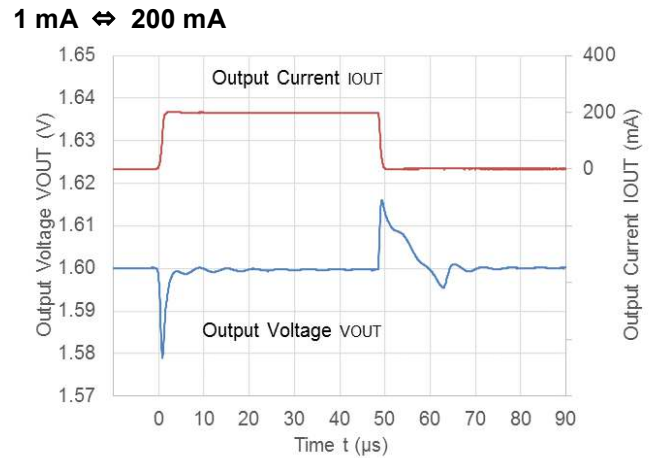
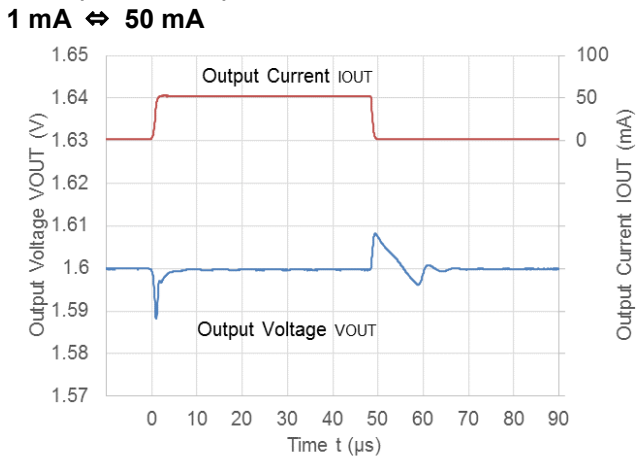

---

**RP155Z**

---

NO.EA-334-190610

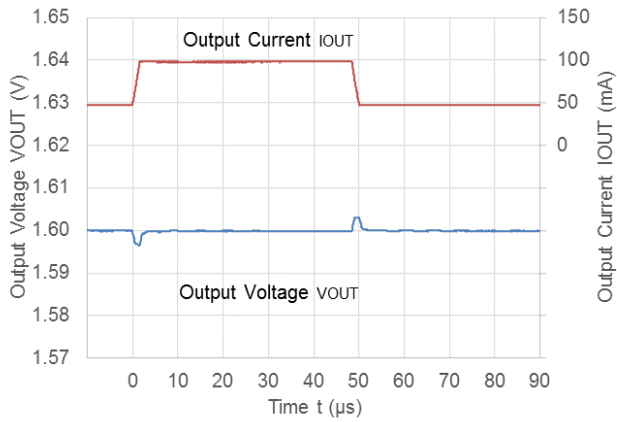
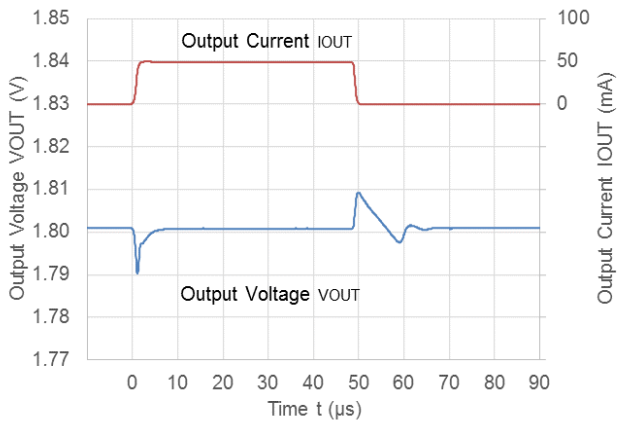
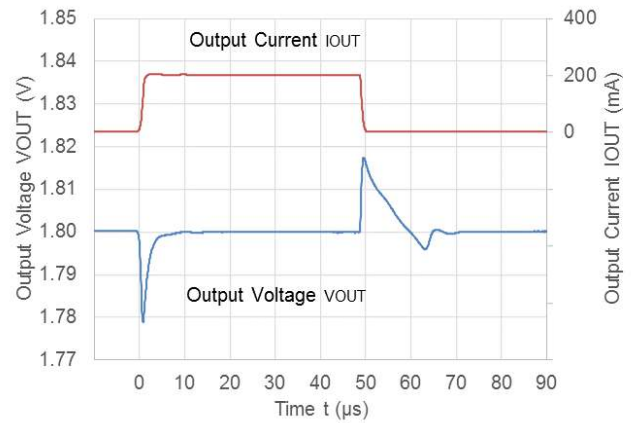
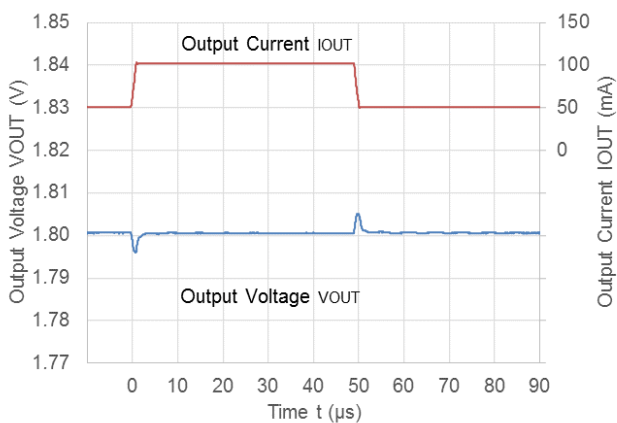
**50 mA  $\leftrightarrow$  200 mA****1.8 V ( $V_{SET1}/V_{SET2}$ ),  $V_{IN} = 2.8$  V  
1 mA  $\leftrightarrow$  50 mA****1 mA  $\leftrightarrow$  200 mA****50 mA  $\leftrightarrow$  200 mA**



**2.85 V ( $V_{SET1}/V_{SET2}$ ),  $V_{IN} = 3.85$  V**  
**1 mA  $\leftrightarrow$  50 mA**

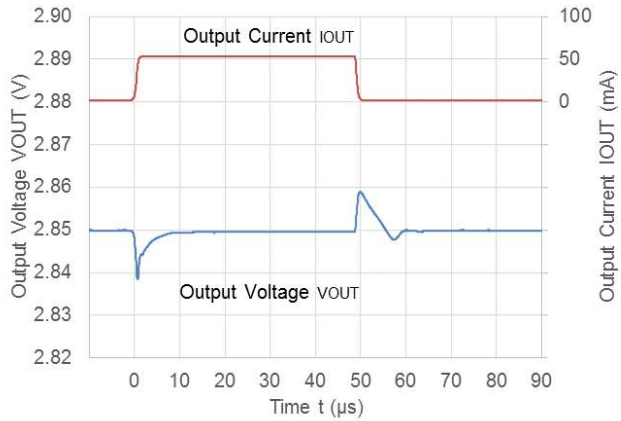

**1 mA  $\leftrightarrow$  200 mA**

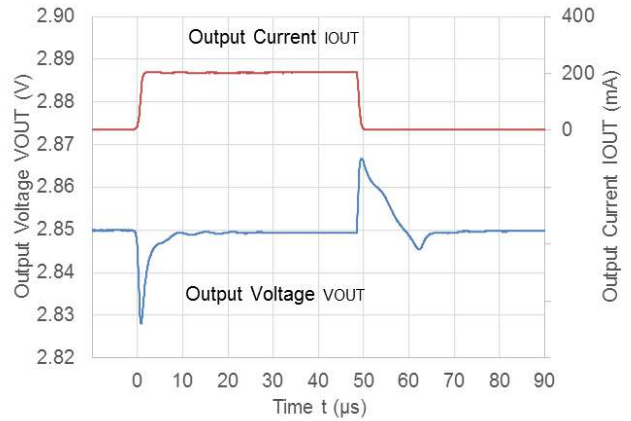

**50 mA  $\leftrightarrow$  200 mA**

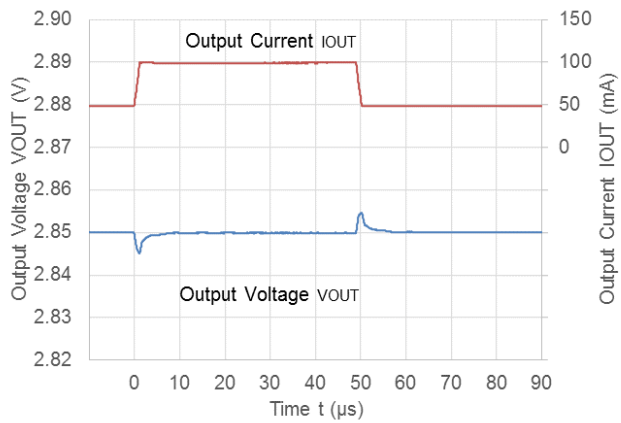

**3.6 V ( $V_{SET1}/V_{SET2}$ ),  $V_{IN} = 4.6$  V**  
**1 mA  $\leftrightarrow$  50 mA**

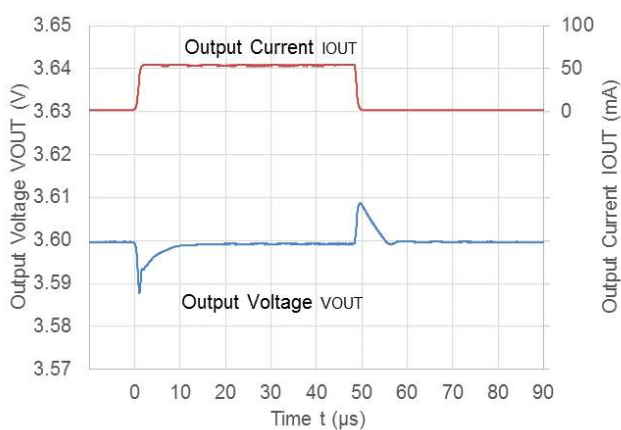

**1 mA  $\leftrightarrow$  200 mA**

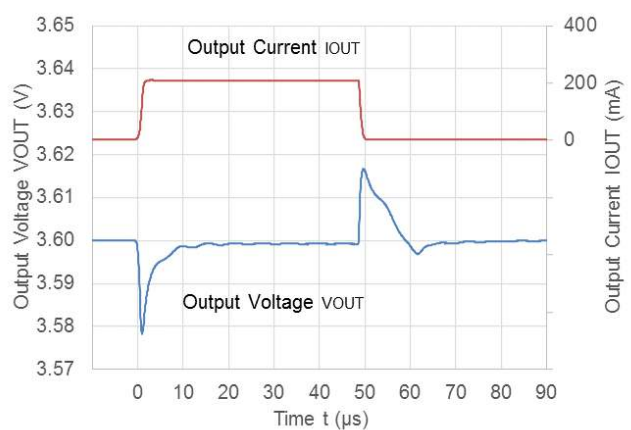

---

**RP155Z**

---

NO.EA-334-190610

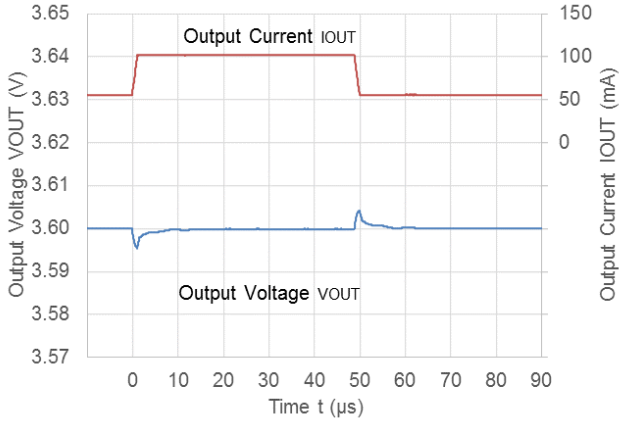
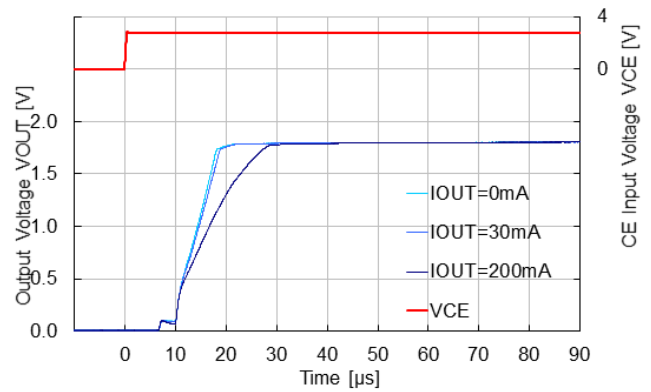
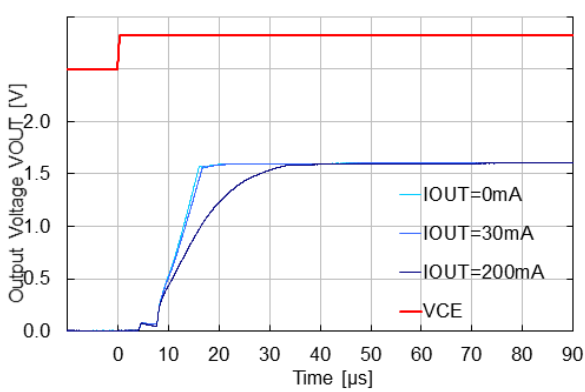
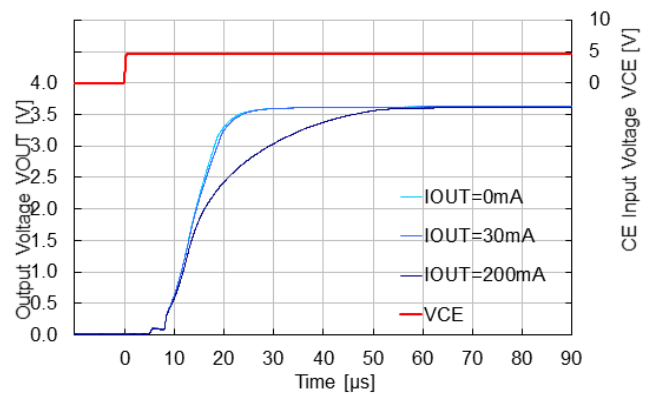
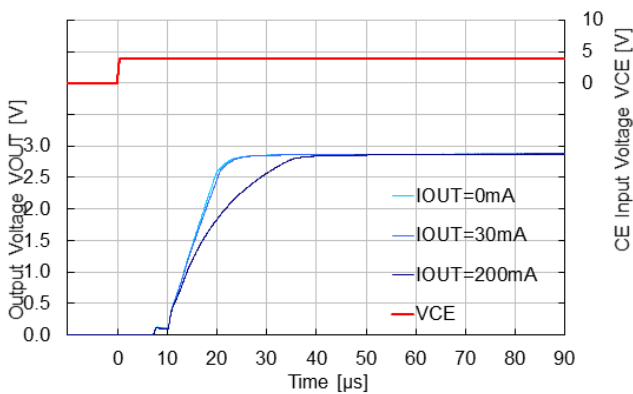
**50 mA  $\leftrightarrow$  200 mA****13) Turn On Speed with CE pin ( $C_{IN}$  = Ceramic 1.0  $\mu$ F,  $C_{OUT}$  = Ceramic 1.0  $\mu$ F,  $T_a$  = 25°C)****1.6 V ( $V_{SET1}/V_{SET2}$ ),  $V_{IN}$  = 2.6 V****1.8 V ( $V_{SET1}/V_{SET2}$ ),  $V_{IN}$  = 2.8 V****2.85 V ( $V_{SET1}/V_{SET2}$ ),  $V_{IN}$  = 3.85 V****3.6 V ( $V_{SET1}/V_{SET2}$ ),  $V_{IN}$  = 4.6 V**

**14) Turn Off Speed with CE pin ( $C_{IN} = \text{Ceramic } 1.0 \mu\text{F}$ ,  $C_{OUT} = \text{Ceramic } 1.0 \mu\text{F}$ ,  $T_a = 25^\circ\text{C}$ )**  
**RP155ZxxxB** **RP155ZxxxB**  
**1.6 V ( $V_{SET1}/V_{SET2}$ ),  $V_{IN} = 2.6 \text{ V}$**  **1.8 V ( $V_{SET1}/V_{SET2}$ ),  $V_{IN} = 2.8 \text{ V}$**

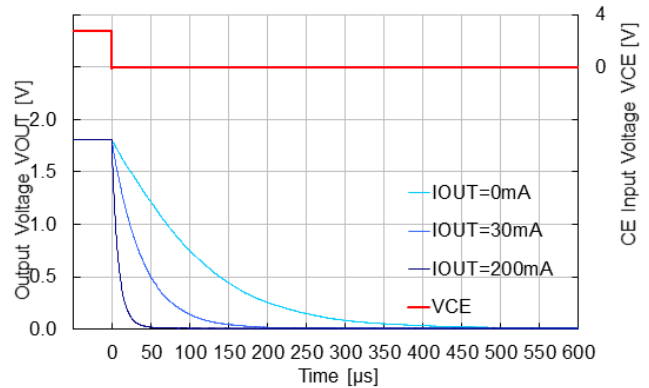
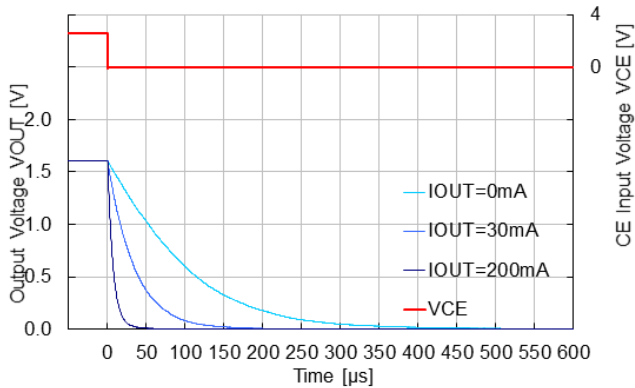

**RP155ZxxxB**  
**2.85 V ( $V_{SET1}/V_{SET2}$ ),  $V_{IN} = 3.85 \text{ V}$**

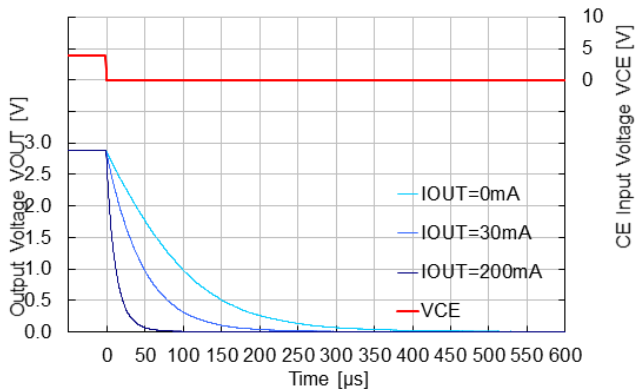

**RP155ZxxxB**  
**3.6 V ( $V_{SET1}/V_{SET2}$ ),  $V_{IN} = 4.6 \text{ V}$**

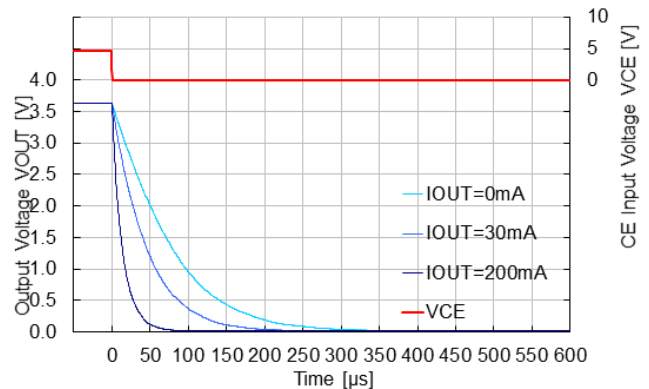

**15)  $V_{OUT}$  Transient Response with VSEL Pin ( $C_{IN} = \text{Ceramic } 1.0 \mu\text{F}$ ,  $C_{OUT} = \text{Ceramic } 1.0 \mu\text{F}$ ,  $t_r = t_f = 5 \mu\text{s}$ ,  $T_a = 25^\circ\text{C}$ )**  
**RP155Z001B** **RP155Z001B**  
 **$V_{SET1} (1.8 \text{ V}) \Rightarrow V_{SET2} (2.85 \text{ V})$**   **$V_{SET2} (2.85 \text{ V}) \Rightarrow V_{SET1} (1.8 \text{ V})$**

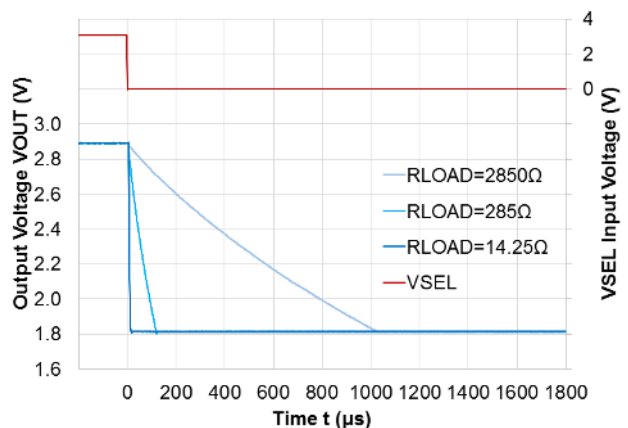
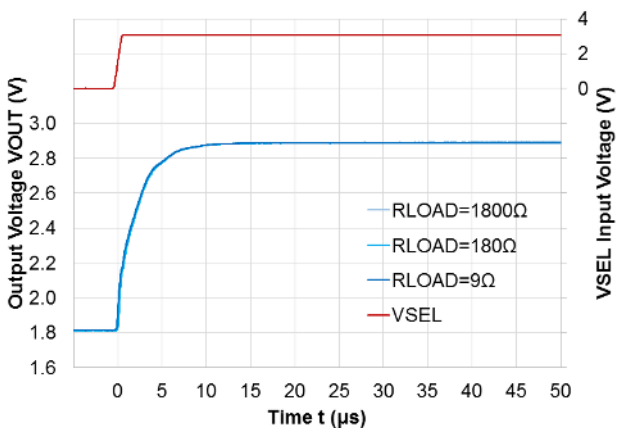

**16) Inrush Current ( $C_{IN} = \text{Ceramic } 1.0 \mu\text{F}$ ,  $I_{OUT} = 0 \text{ mA}$ ,  $T_a = 25^\circ\text{C}$ )**

**1.6 V ( $V_{SET1}/V_{SET2}$ ),  $V_{IN} = 2.6 \text{ V}$**

**1.8 V ( $V_{SET1}/V_{SET2}$ ),  $V_{IN} = 2.8 \text{ V}$**

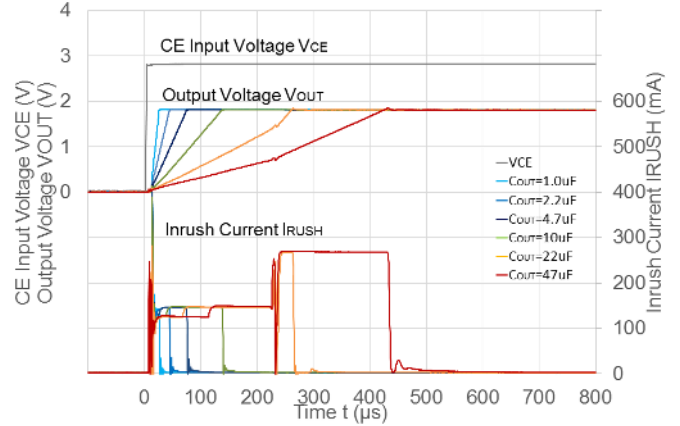
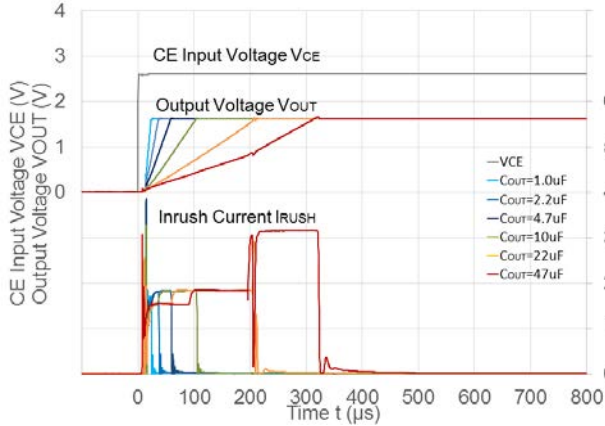

**2.85 V ( $V_{SET1}/V_{SET2}$ ),  $V_{IN} = 3.85 \text{ V}$**

**3.6 V ( $V_{SET1}/V_{SET2}$ ),  $V_{IN} = 4.6 \text{ V}$**

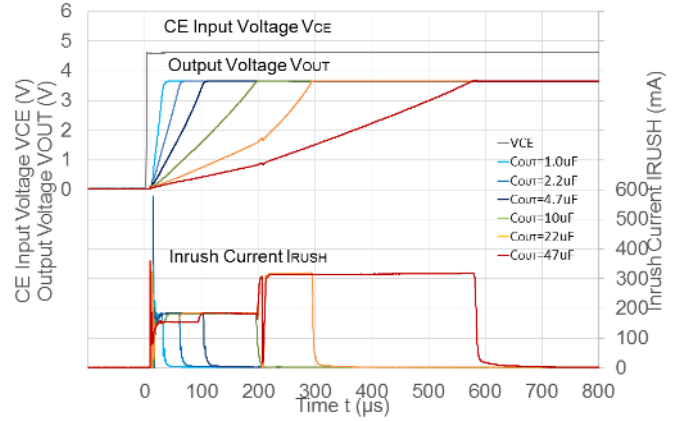
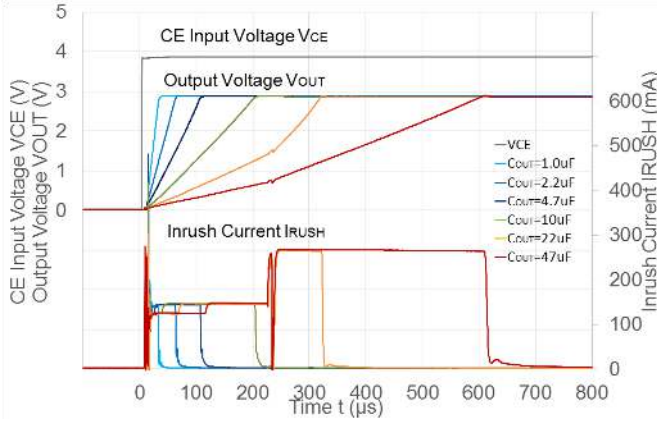

**Test Circuit**

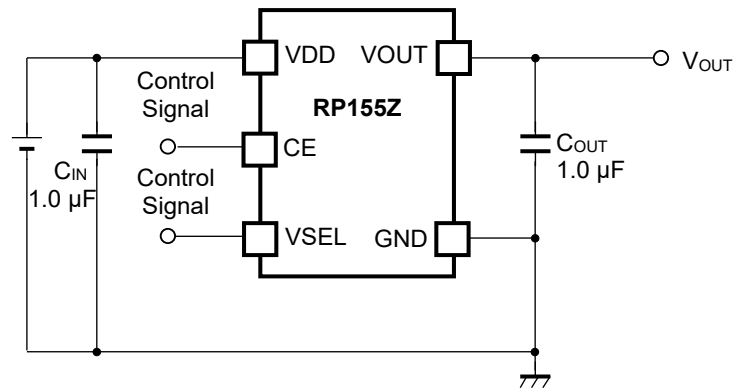

**RP155Z circuit for measuring Typical Characteristics**

**Measurement Components of Typical Characteristics**

Symbol	Description
C <sub>IN</sub> , C <sub>OUT</sub>	Ceramic Capacitor, 1.0 μF, GRM155B31A105KE15, MURATA

## EQUIVALENT SERIES RESISTANCE VS. OUTPUT CURRENT

A ceramic output capacitor is recommended to be used but any output capacitor with low ESR could also be used. The graphs below show the relations between output current and ESR of an output capacitor when the average white noise level is 40  $\mu\text{V}$  or less.

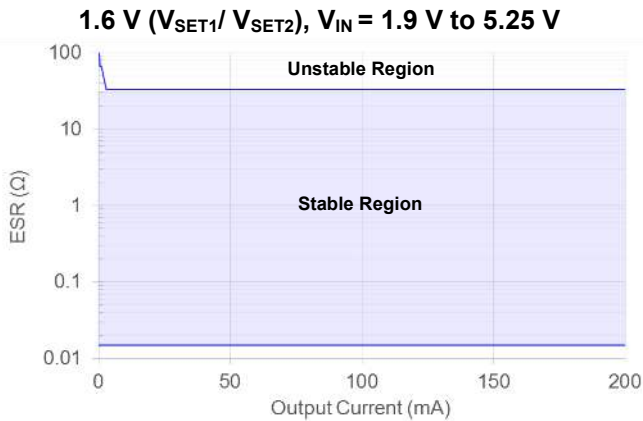
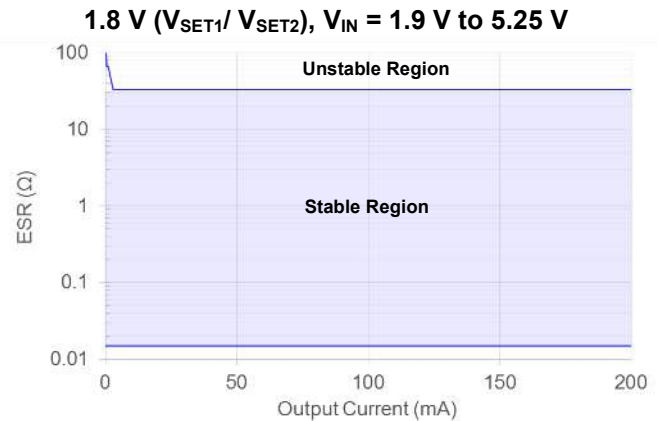
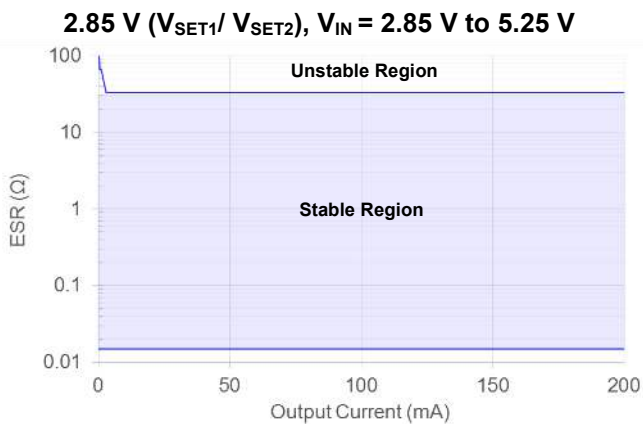
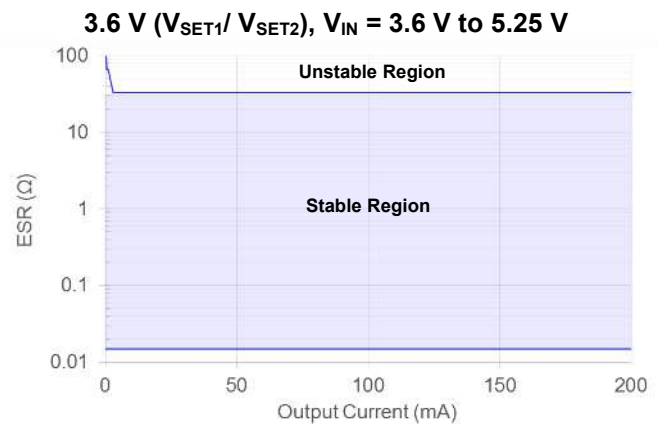
**Fig. 1 Range of Stable ESR Values****Fig. 2 Range of Stable ESR Values****Fig. 3 Range of Stable ESR Values****Fig. 4 Range of Stable ESR Values**

The power dissipation of the package is dependent on PCB material, layout, and environmental conditions. The following measurement conditions are based on JEDEC STD. 51.

**Measurement Conditions**

Item	Measurement Conditions
Environment	Mounting on Board (Wind Velocity = 0 m/s)
Board Material	Glass Cloth Epoxy Plastic (Four-Layer Board)
Board Dimensions	101.5 mm x 114.5 mm x 1.6 mm
Copper Ratio	Outer Layer (First Layer): 10% 50um Inner Layers (Second and Third Layers): 99.5 x 99.5mm 100% 70um Outer Layer (Fourth Layer): 10% 50um

**Measurement Result**

(Ta = 25°C, Tjmax = 125°C)

Item	Measurement Result
Power Dissipation	550 mW
Thermal Resistance ( $\theta_{ja}$ )	$\theta_{ja} = 180^\circ\text{C/W}$

$\theta_{ja}$ : Junction-to-Ambient Thermal Resistance

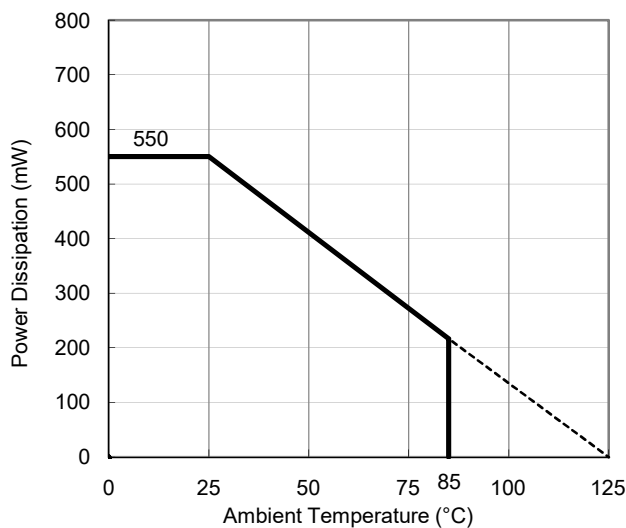

**Power Dissipation vs. Ambient Temperature**

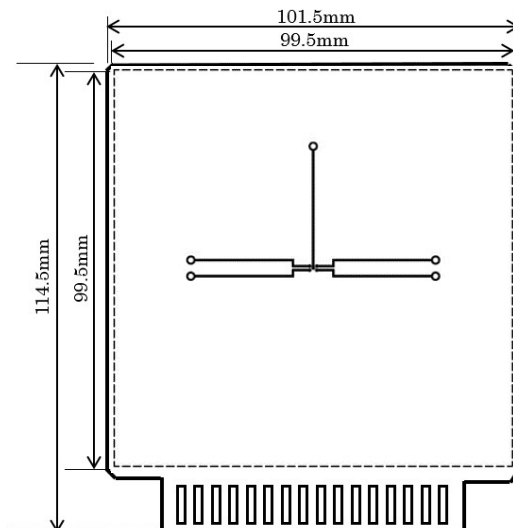

**Measurement Board Pattern**

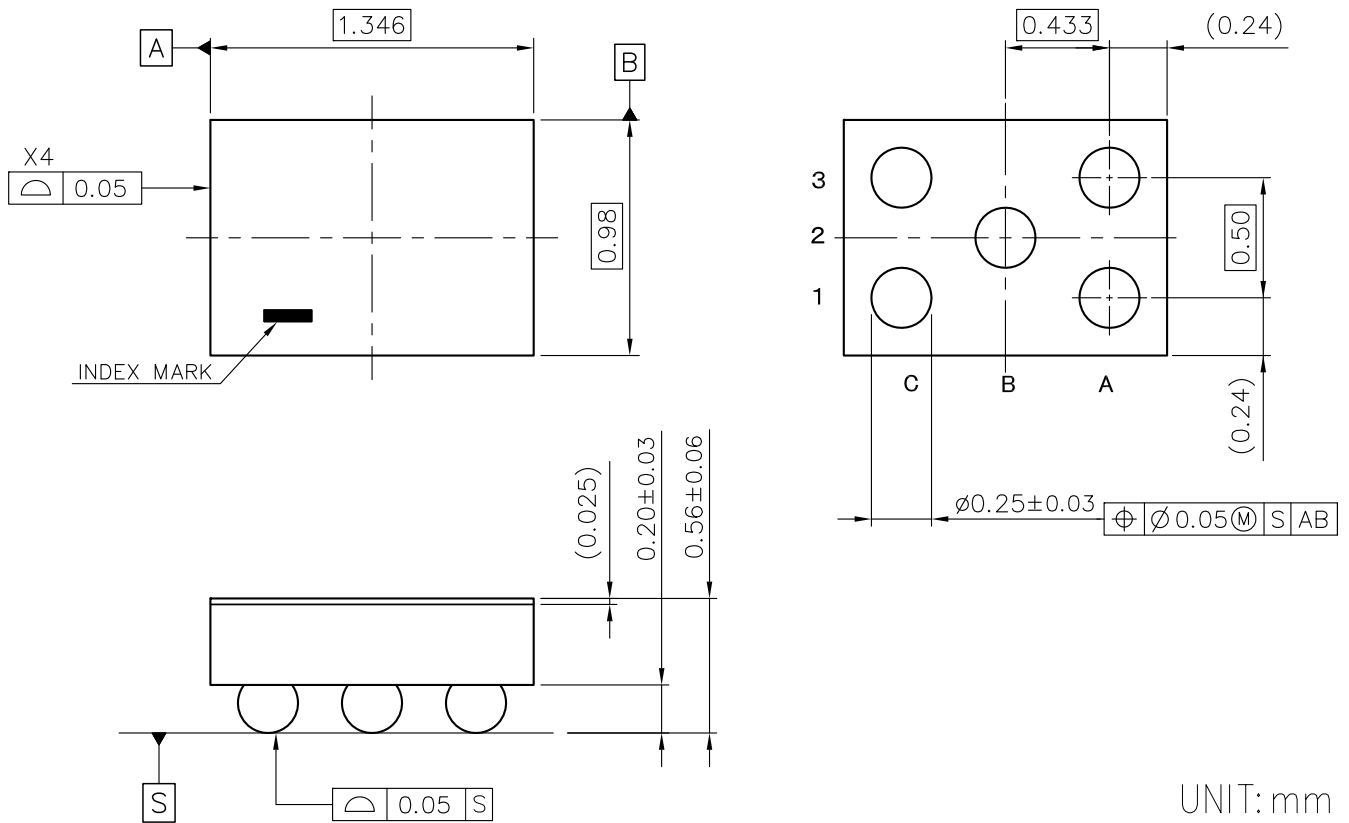

UNIT: mm

WLCSP-5-P1 Package Dimensions





1. The products and the product specifications described in this document are subject to change or discontinuation of production without notice for reasons such as improvement. Therefore, before deciding to use the products, please refer to our sales representatives for the latest information thereon.
2. The materials in this document may not be copied or otherwise reproduced in whole or in part without prior written consent of our company.
3. Please be sure to take any necessary formalities under relevant laws or regulations before exporting or otherwise taking out of your country the products or the technical information described herein.
4. The technical information described in this document shows typical characteristics of and example application circuits for the products. The release of such information is not to be construed as a warranty of or a grant of license under our company's or any third party's intellectual property rights or any other rights.
5. The products listed in this document are intended and designed for use as general electronic components in standard applications (office equipment, telecommunication equipment, measuring instruments, consumer electronic products, amusement equipment etc.). Those customers intending to use a product in an application requiring extreme quality and reliability, for example, in a highly specific application where the failure or misoperation of the product could result in human injury or death (aircraft, spacevehicle, nuclear reactor control system, traffic control system, automotive and transportation equipment, combustion equipment, safety devices, life support system etc.) should first contact us.
6. We are making our continuous effort to improve the quality and reliability of our products, but semiconductor products are likely to fail with certain probability. In order to prevent any injury to persons or damages to property resulting from such failure, customers should be careful enough to incorporate safety measures in their design, such as redundancy feature, fire containment feature and fail-safe feature. We do not assume any liability or responsibility for any loss or damage arising from misuse or inappropriate use of the products.
7. Anti-radiation design is not implemented in the products described in this document.
8. The X-ray exposure can influence functions and characteristics of the products. Confirm the product functions and characteristics in the evaluation stage.
9. WLCSP products should be used in light shielded environments. The light exposure can influence functions and characteristics of the products under operation or storage.
10. There can be variation in the marking when different AOI (Automated Optical Inspection) equipment is used. In the case of recognizing the marking characteristic with AOI, please contact our sales or our distributor before attempting to use AOI.
11. Please contact our sales representatives should you have any questions or comments concerning the products or the technical information.



**Nisshinbo Micro Devices Inc.**

**Official website**

<https://www.nisshinbo-microdevices.co.jp/en/>

**Purchase information**

<https://www.nisshinbo-microdevices.co.jp/en/buy/>

