

# ***UCC28019EVM 350-W PFC Converter***

## *User's Guide*

# ***UCC28019EVM 350-W PFC Converter***

## ***User's Guide***

Literature Number: SLUU272  
May 2007



## **UCC28019EVM 350-W PFC Converter**

---

---

---

The UCC28019 evaluation module (EVM) is a 350-W off-line Power Factor Correction (PFC) boost converter providing a 390-V regulated output at 0.9 A of load current. The PFC converter accommodates an input voltage range of 85 VAC to 265 VAC and uses average current mode control at a fixed frequency of 65 kHz. The UCC28019 incorporates a wide range of protection features to ensure safe system operation.

### **1 Description**

The UCC28019EVM highlights the many benefits of using the UCC28019 Continuous Current Mode PFC Controller ([TI Literature Number SLUS755](#)). The controller operates under average current mode control at a fixed frequency of 65 kHz. Simple external current and voltage loop compensation, along with advanced protection features, make this controller ideal for server and desktop power supplies, telecom rectifiers, and home electronics.

This user's guide provides the schematic, component list, assembly drawing for a single-sided printed circuit board application, and test set up necessary to evaluate the UCC28019 in a typical PFC application.

### **2 Applications**

The UCC28019 is suited for use in high-power off-line systems requiring high-efficiency and advanced fault protection features including:

- Server and desktop power supplies
- Telecom rectifiers
- Home electronics

### **3 Features**

The UCC28019EVM features include:

- 350-W, 390-V output
- Universal off-line input voltage range
- Average current mode PWM control
- Fixed 65-kHz oscillator frequency
- Cycle-by-cycle peak current limiting
- VCC under-voltage lockout
- Voltage regulation open-loop detection
- Output under-voltage protection
- Output over-voltage protection
- AC input brown-out protection
- Enhanced dynamic response
- Soft-start

## 4 UCC28019EVM Electrical Performance Specification

### CAUTION

High voltage levels are present on the evaluation module whenever it is energized. Proper precautions must be taken when working with the EVM. The large bulk capacitor across the output terminals must be completely discharged before the EVM can be handled. Serious injury can occur if proper safety precautions are not followed.

**Table 1. UCC28019EVM Performance Summary**

	PARAMETER	TEST CONDITION	MIN	TYP	MAX	UNIT
<b>Input Characteristics</b>						
$V_{IN}$	Input voltage		85		265	VAC
$f_{LINE}$	Input frequency		47		63	Hz
$I_{IN(No\_Load)}$	No load input current	$V_{IN} = 265 \text{ VAC}$ , $f_{LINE} = 50 \text{ Hz}$ $I_{OUT} = 0 \text{ A}$		80		mA
$I_{IN(MAX)}$	Maximum input current	$V_{IN} = 85 \text{ VAC}$ , $f_{LINE} = 50 \text{ Hz}$ $I_{OUT} = 0.9 \text{ A}$		4.52		A
$V_{IN(TURN\_ON\_THRESHOLD)}$	Brown out voltage	$I_{OUT} = 0.9 \text{ A}$		82		VAC
$V_{IN(TURN\_OFF\_THRESHOLD)}$		$I_{OUT} = 0.9 \text{ A}$		66		
<b>Output Characteristics</b>						
$V_{OUT}$	Output voltage	$85 \text{ VAC} \leq V_{IN} \leq 265 \text{ VAC}$ $47 \text{ Hz} \leq f_{LINE} \leq 63 \text{ Hz}$ $0 \text{ A} \leq I_{OUT} \leq 0.9 \text{ A}$	370.5	390	409.5	VDC
	Line regulation	$85 \text{ VAC} \leq V_{IN} \leq 265 \text{ VAC}$ $I_{OUT} = 0.45 \text{ A}$		0.41%	5%	
	Load regulation	$V_{IN} = 115 \text{ VAC}$ , $f_{LINE} = 60 \text{ Hz}$ $0 \text{ A} \leq I_{OUT} \leq 0.9 \text{ A}$		0.05%	5%	
		$V_{IN} = 230 \text{ VAC}$ , $f_{LINE} = 50 \text{ Hz}$ $0 \text{ A} \leq I_{OUT} \leq 0.9 \text{ A}$		0.67%	5%	
$V_{RIPPLE(SW)}$	High frequency output voltage ripple	$V_{IN} = 115 \text{ VAC}$ , $f_{LINE} = 60 \text{ Hz}$ $I_{OUT} = 0.9 \text{ A}$		1.68	3.9	V <sub>P-P</sub>
		$V_{IN} = 230 \text{ VAC}$ , $f_{LINE} = 50 \text{ Hz}$ $I_{OUT} = 0.9 \text{ A}$		1.12	3.9	
$V_{RIPPLE(f\_LINE)}$	Line frequency output voltage ripple	$V_{IN} = 115 \text{ VAC}$ , $f_{LINE} = 60 \text{ Hz}$ $I_{OUT} = 0.9 \text{ A}$		10.8	19.5	
		$V_{IN} = 230 \text{ VAC}$ , $f_{LINE} = 50 \text{ Hz}$ $I_{OUT} = 0.9 \text{ A}$		12.4	19.5	
$I_{OUT}$	Output load current	$85 \text{ VAC} \leq V_{IN} \leq 265 \text{ VAC}$ $47 \text{ Hz} \leq f_{LINE} \leq 63 \text{ Hz}$			0.9	A
$P_{OUT}$	Output power				350	W
$V_{OUT(OVP)}$	Output over voltage protection			410		V
$V_{OUT(UVD)}$	Output under voltage detection			370		

**Table 1. UCC28019EVM Performance Summary (continued)**

	PARAMETER	TEST CONDITION	MIN	TYP	MAX	UNIT
<b>Control Loop Characteristics</b>						
$f_{SW}$	Switching frequency	$T_J = 25^\circ\text{C}$	61.7	65	68.3	kHz
$f_{(CO)}$	Control loop bandwidth	$V_{IN} = 162\text{ VDC},$ $I_{OUT} = 0.45\text{ A}$		9.3		Hz
	Phase margin	$V_{IN} = 162\text{ VDC},$ $I_{OUT} = 0.45\text{ A}$		70		degrees
PF	Power factor	$V_{IN} = 115\text{ VAC}, I_{OUT} = 0.9\text{ A}$	0.99			
THD	Total harmonic distortion	$V_{IN} = 115\text{ VAC}, f_{LINE} = 60\text{ Hz}$ $I_{OUT} = 0.9\text{ A}$		4.13%	10%	
		$V_{IN} = 230\text{ VAC}, f_{LINE} = 50\text{ Hz}$ $I_{OUT} = 0.9\text{ A}$		6.77%	10%	
$\eta_{PEAK}$	Peak efficiency	$V_{IN} = 265\text{ VAC}, f_{LINE} = 50\text{ Hz},$ $I_{OUT} = 0.9\text{ A}$		97.3%		
$\eta_{FL}$	Full Load Efficiency	$V_{IN} = 115\text{ VAC}, f_{LINE} = 60\text{ Hz},$ $I_{OUT} = 0.9\text{ A}$		94.4%		
$T_A$	Ambient Temperature			25		$^\circ\text{C}$

5 Schematic

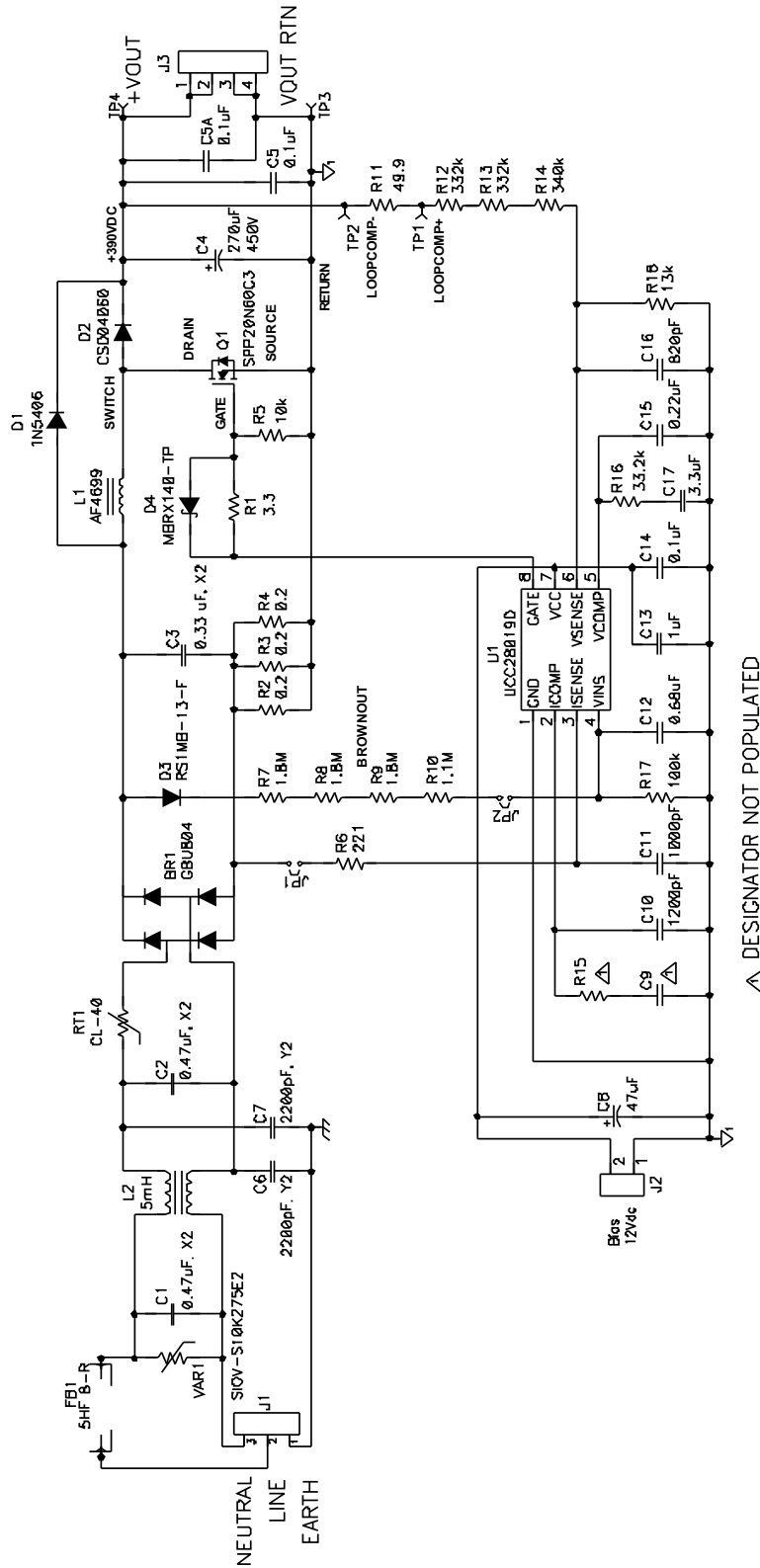

Figure 1. UCC28019EVM Schematic

## 6 EVM Test Setup

Figure 2 shows the basic test set up recommended to evaluate the UCC28019EVM.

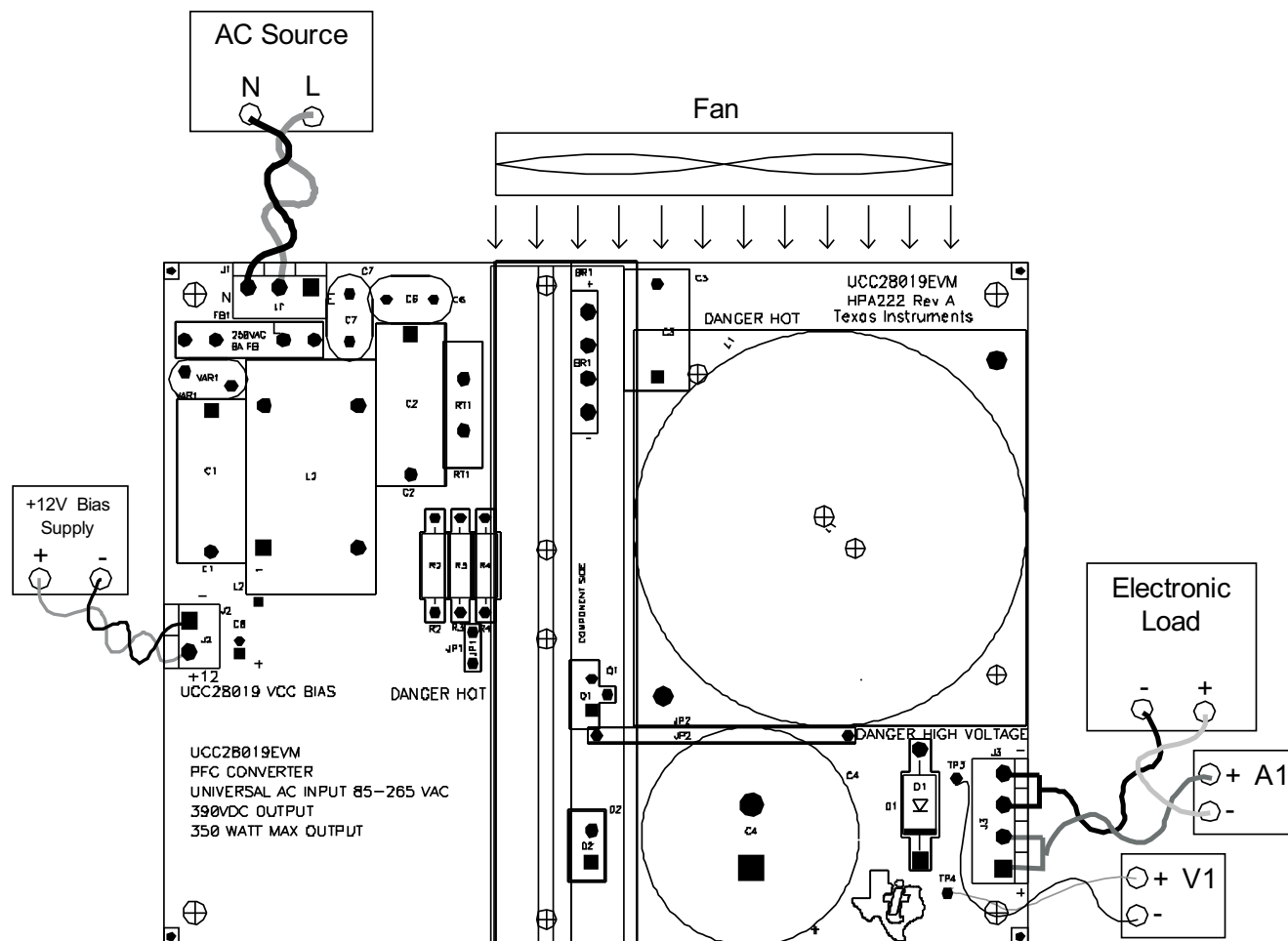

Figure 2. UCC28019EVM Test Set Up

### **6.1 AC Source**

The ac input source shall be capable of supplying between 85 VAC and 265 VAC at no less than 8 A peak. Connect the ac source to the L and N terminals of J1 on the EVM as shown in [Figure 2](#).

### **6.2 12-V Bias Supply**

The bias supply to the device shall be capable of supplying up to 12 VDC at no less than 10 mA. Connect the bias supply to the – and +12 terminals of J2, UCC28019 VCC BIAS, as shown in [Figure 2](#).

### **6.3 Electronic Load**

A programmable electronic load set to constant current mode and capable of sinking 0 A to 1 A at 390 VDC shall be used.

### **6.4 Digital Multimeters**

For highest accuracy, the output voltage of the UCC28019EVM shall be monitored by connecting a digital voltmeter, V1, directly across TP3 and TP4 with the positive terminal at TP4 and the negative terminal at TP3, as shown in [Figure 2](#). A dc current meter, A1, should be placed in series with the electronic load for accurate output current measurements.

### **6.5 Recommended Wire Gauge**

The connection between the ac source and the EVM input terminals can carry as much as 8 A peak during brownout testing. The recommended wire size is AWG #16 with the total length of wire less than 8 feet (4 feet input, 4 feet return). The connection between the EVM output terminals (J3) and the electronic load can carry as much as 1 A. The minimum recommended wire size is AWG #20, with the total length of wire less than 8 feet (4 feet output, 4 feet return).

### **6.6 Fan**

A fan, capable of 200 LFM to 400 LFM, should be used to maintain component temperatures within safe operating ranges at all times during operation of the UCC28091EVM. Position the fan so as to blow along the length of the heatsink as shown in [Figure 2](#).



## 7 Power-Up/Power-Down Procedure

The following test procedure is recommended primarily for power up and shutting down the evaluation module. Never leave a powered EVM unattended for any length of time. Also, the unit should never be handled while power is applied to it or the output voltage is greater than 50 VDC.

### **WARNING**

**There are very high voltages present on the EVM. Some components will reach temperatures above 50°C. Precautions must be taken when handling the board. Never operate the UCC28019EVM without the fan running. Always make certain the bulk capacitors have completely discharged prior to handling the EVM.**

1. Working at an ESD workstation, make sure that the ionizer is on before the EVM is removed from the protective packaging and power is applied. Electrostatic smock and safety glasses should also be worn. Because voltages in excess of 400 V may be present on the EVM, do not connect the ground strap from the smock to the bench.
2. Power-UP
  - a. Connect the equipment as shown in [Figure 2](#).
  - b. Turn on the fan.
  - c. Prior to turning on the ac source, limit the source current to 8 A and then turn on the ac source.
  - d. Turn on the 12-V bias supply and verify that the output is within regulation.
  - e. Increase the load from 0 A up to 0.9 A.
  - f. The DRAIN, SOURCE, GATE, SWITCH node, RETURN, and VOUT+ are labeled on the surface mount side of the board for user access.
3. Power-Down
  - a. Turn off ac source.
  - b. Turn off bias supply.
  - c. Discharge the output capacitor.
  - d. Turn off the load.

## 8 UCC28019EVM Performance Data and Characteristic Curves

The vertical lines on the following figures represent 20%, 50% and 100% load.

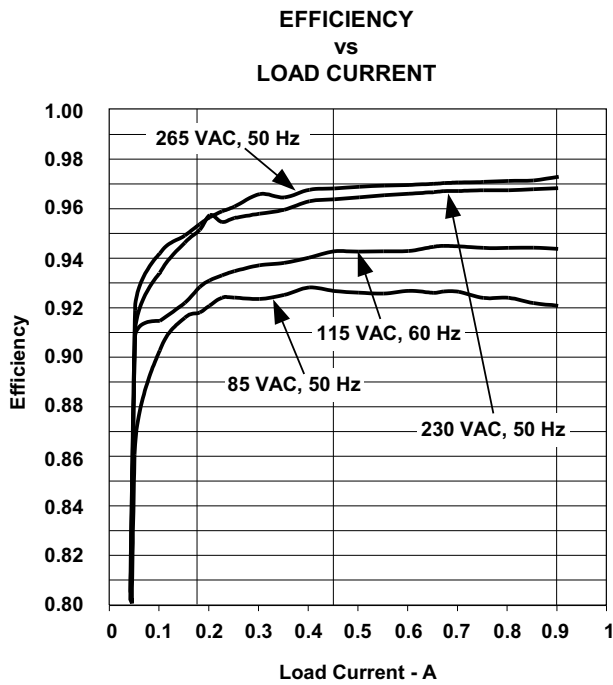

Figure 3. Efficiency as a Function of Line Voltage and Load Current

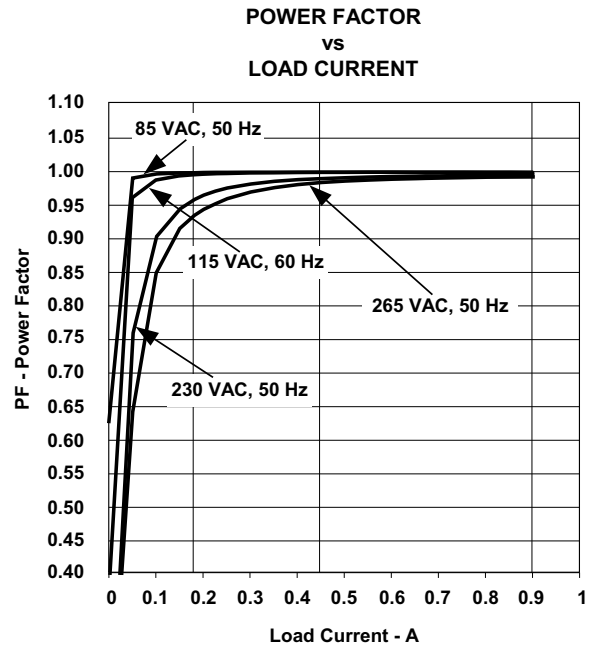

Figure 4. Power Factor as a Function of Line Voltage and Load Current

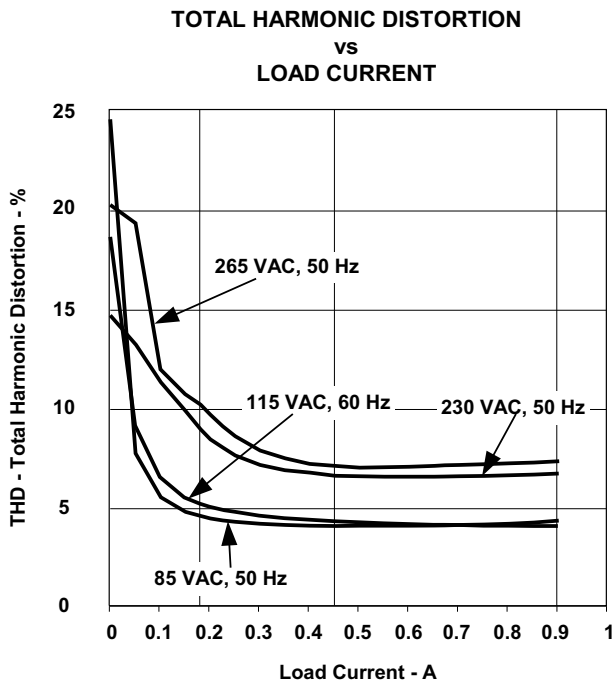

Figure 5. Total Harmonic Distortion as a Function of Line Voltage and Load Current

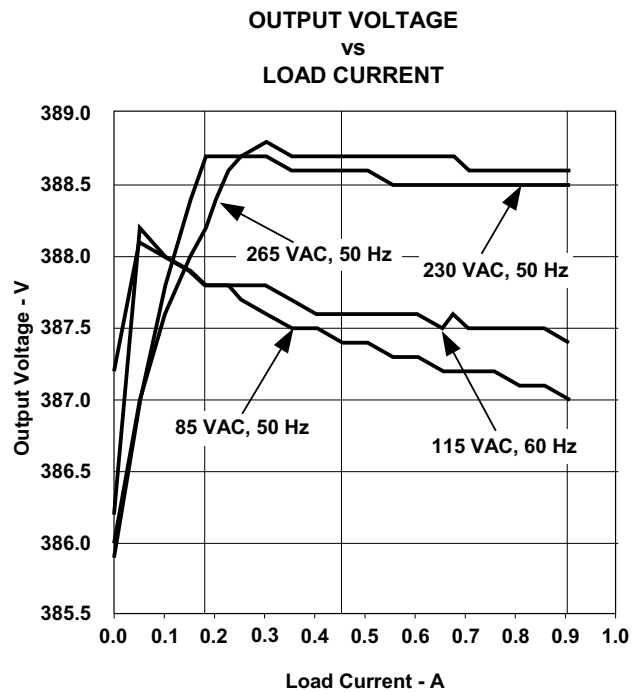

Figure 6. Output Voltage as a Function of Line Voltage and Load Current

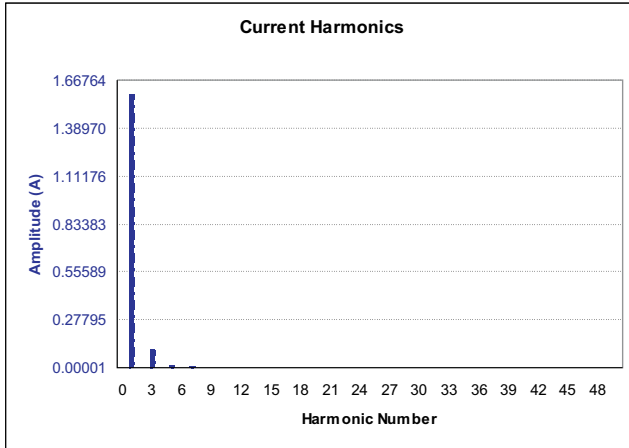

Figure 7. Current Harmonics, 230 VAC, 50 Hz input, Full Load

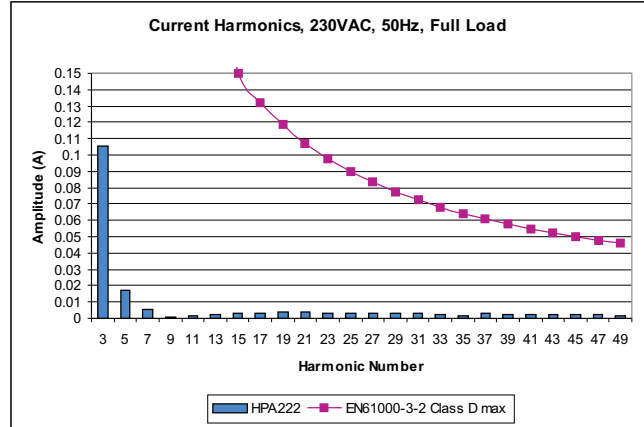

Figure 8. Current Harmonics, 230 VAC, 50 Hz Input, Full Load, Re-Scaled Without the Fundamental

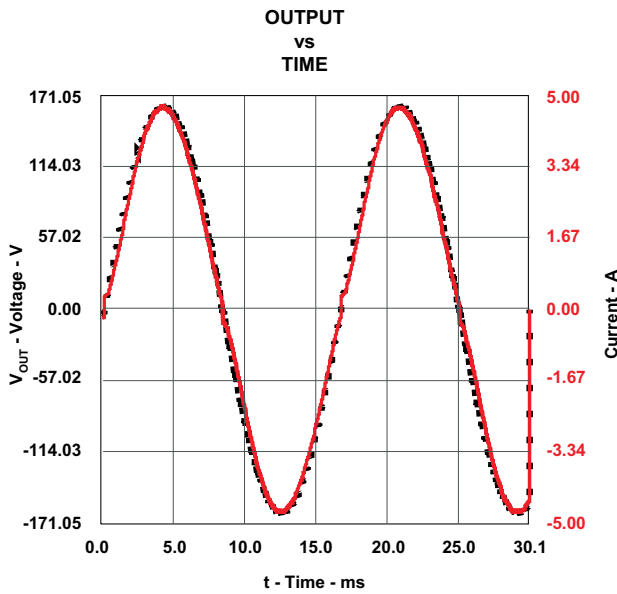

Figure 9. Input Voltage and Current Waveforms, 115 VAC, 60 Hz, Full Load

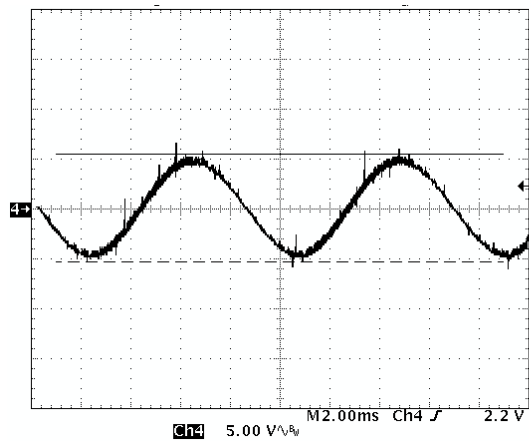
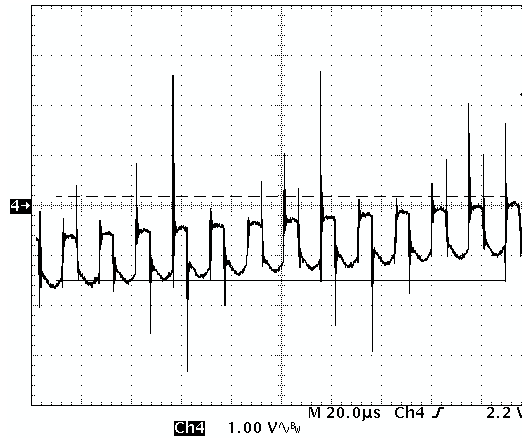
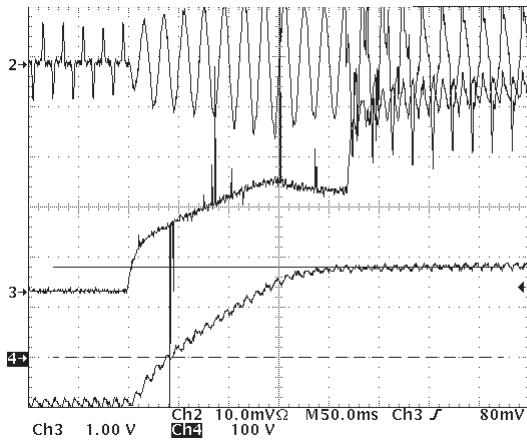

Figure 10. Line Frequency Output Voltage Ripple, 115 VAC, 60 Hz Input, Full Load

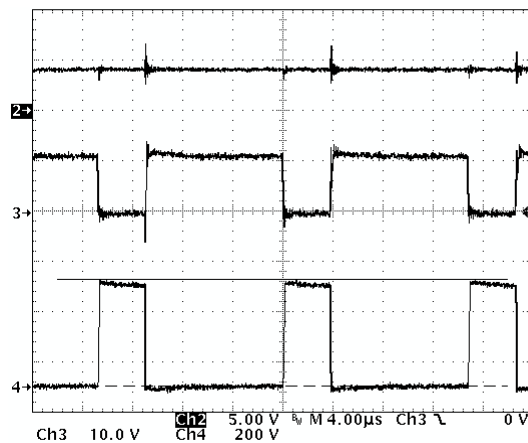

**Figure 11. Switching Frequency Output  
Voltage Ripple, 115 VAC, 60 Hz Input, Full  
Load**

The following figure shows the start-up waveform of the UCC28019EVM as the 12-V bias supply is turned on. Note the constant  $30\ \mu\text{A}$  of source current from VCOMP into the compensation capacitor which allows a linear voltage rise enabling a controlled increase of the input current until the output voltage reaches 95% of its regulated output voltage (370.5 VDC).



**Figure 12. Start-Up Waveform (115 VAC, 60  
Hz, 0.45 A load. Ch1 =  $I_{IN}$  @ 5 A/div, Ch.2 =  
VCOMP @ 2 V/div, Ch. 3 = VSENSE @ 5  
V/div, Ch. 4 = VOUT @ 100 V/div offset by 155  
VDC)**



**Figure 13. Switching Waveform (115 VAC, 60  
Hz, full load. Ch. 2 = VCOMP @ 5 V/div, Ch. 3  
= GATE @ 10 V/div, Ch. 4 = DRAIN @ 200  
V/div.)**

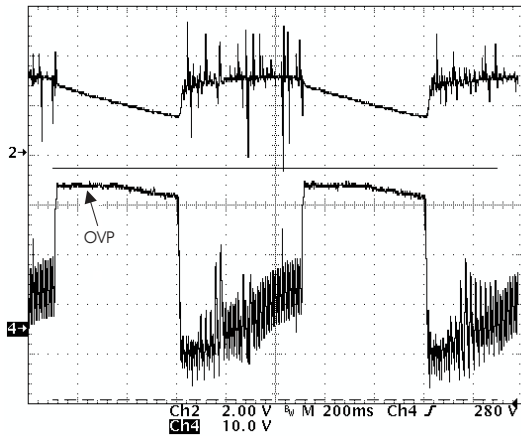

**Figure 14. Load Transient (Load step: 0% to 100%. Ch. 2 = V<sub>COMP</sub> @ 2 V/div., Ch. 4 = V<sub>OUT</sub> @ 10 V/div. offset by 375 VDC. Note the plateau on V<sub>OUT</sub> (Ch. 4) resulting from OVP triggering at 404.4 V.)**

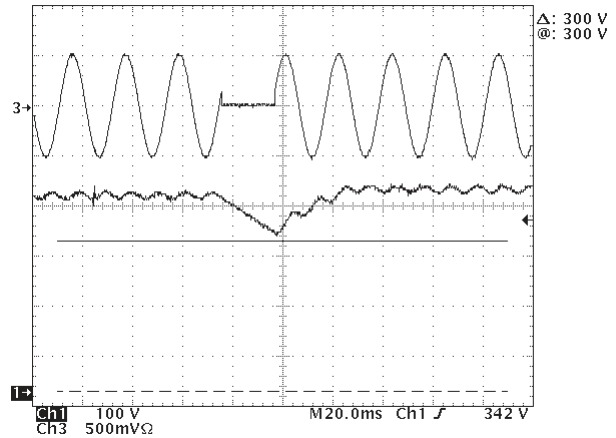

**Figure 15. Line Drop Out, V<sub>IN</sub> = 85 VAC, 50 Hz, Full Load (Ch. 3 = V<sub>IN</sub> @ 500 mV X 200 V/div; measured with a differential probe, Ch. 1 = V<sub>OUT</sub> @ 100 V/div. Drop out was one line cycle.)**

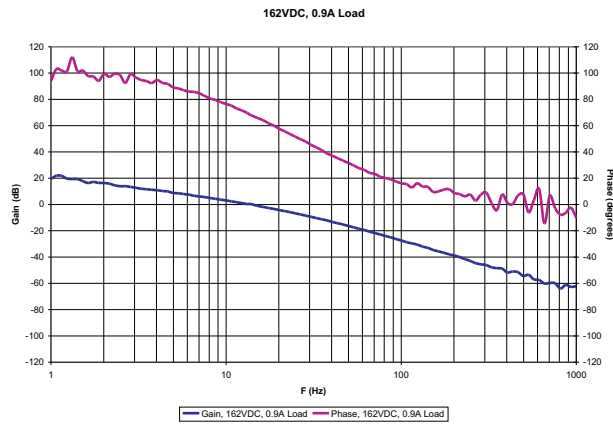

**Figure 16. Bode Plot (162 VDC input, full load. Crossover frequency = 13 Hz, phase margin = 68°.)**

## 9 Board Layout Diagrams

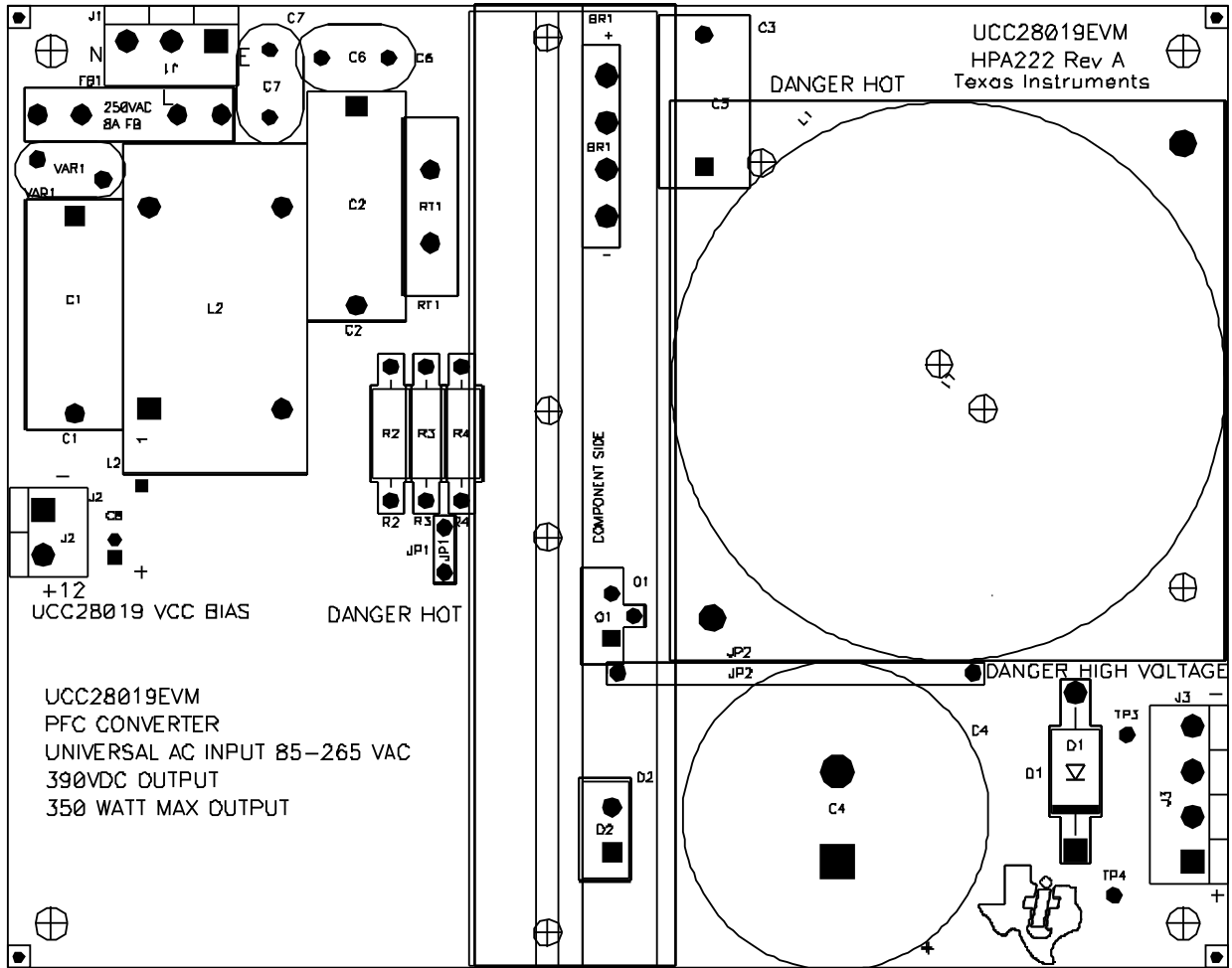

Figure 17. Top layer Component Placement

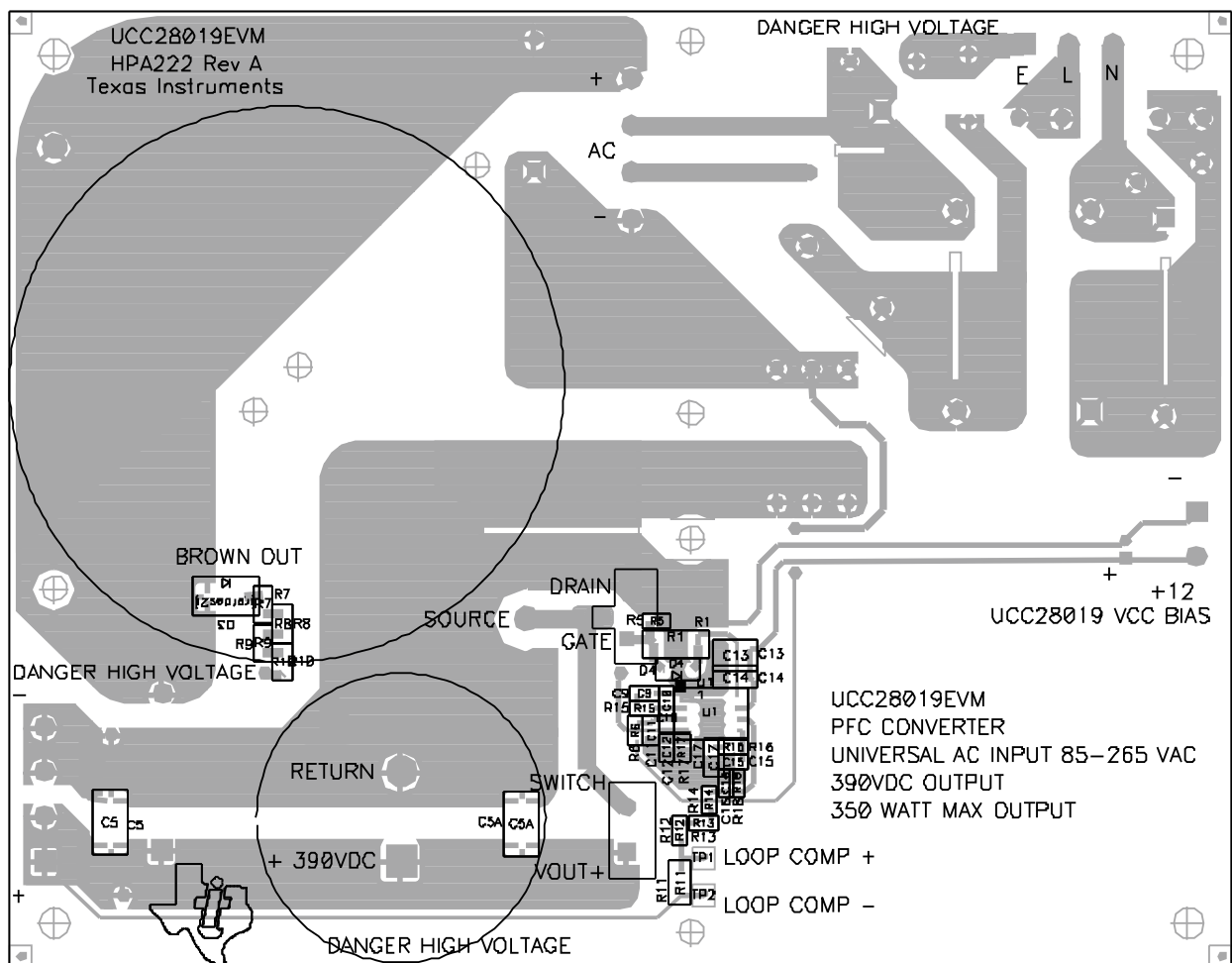

Figure 18. Bottom Layer





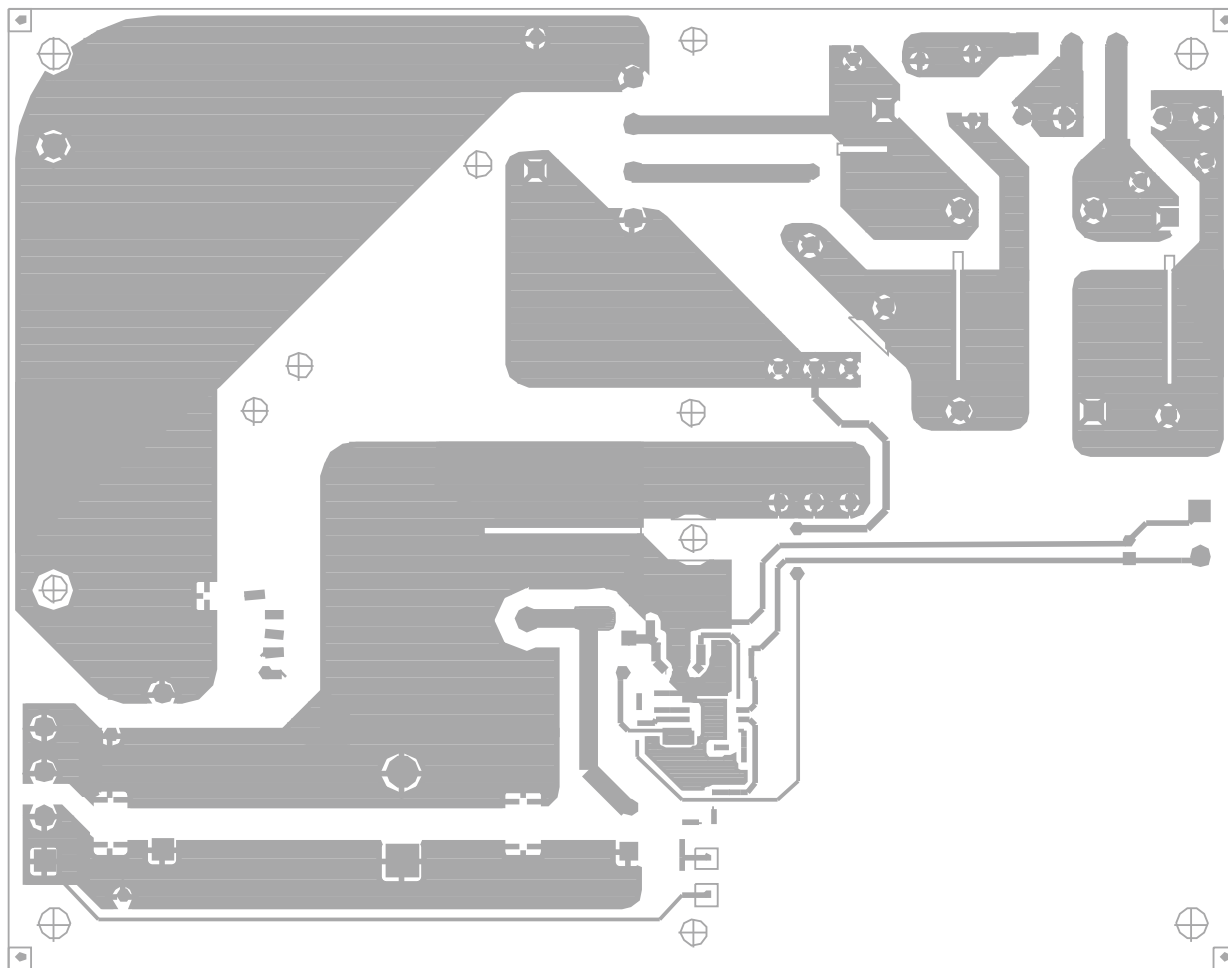

Figure 20. Bottom Layer Routing

**10 List of Materials****Table 2. List of Materials<sup>(1)(2)(3)(4)</sup>**

RefDes	COU NT	Description	MFR	Part Number
BR1	1	Diode, bridge rectifier, 8 A, 400 V, 0.880 x 0.140 inch	Diode Inc.	GBU804
C1, C2	2	Capacitor, film, 0.47 $\mu$ F, X2, 275 VAC, $\pm$ 20%, 0.236 x 0.591 inch	Panasonic	ECQ-U2A474ML
C3	1	Capacitor, film, 0.33 $\mu$ F, X2, 275 VAC, $\pm$ 20%, 0.690 x 0.374 inch	Panasonic	ECQ-U2A334ML
C4	1	Capacitor, aluminum, 270 $\mu$ F, 450 VDC, $\pm$ 20%, 30 x 30 mm	Panasonic	EETUQ2W271DA
C5, C5A	2	Capacitor, ceramic, 0.1 $\mu$ F, 630 V, X7R, $\pm$ 10%, 1812	muRata	GRM43DR72J104KW01L
C6, C7	2	Capacitor, ceramic disc, 2200 pF, Y2, 250 VAC, $\pm$ 20%, 0.276 x 0.413 inch	TDK Corporation	CS11-E2GA222MYNS
C8	1	Capacitor, aluminum, 47 $\mu$ F, 35 V, $\pm$ 20%, 0.200 x 0.435 inch	Panasonic	ECA-1VM470
C9	0	Capacitor, ceramic, not populated, 50 V, X7R, $\pm$ 10%, 0603	muRata	not populated
C10	1	Capacitor, ceramic, 1200 pF, 50 V, X7R, $\pm$ 10%, 0603	Panasonic	ECJ-1VB1H122K
C11	1	Capacitor, ceramic, 1000 pF, 100 V, X7R, $\pm$ 10%, 0603	Panasonic	ECJ-1VB2A1001K
C12	1	Capacitor, ceramic, 0.68 $\mu$ F, 10 V, X7R, $\pm$ 10%, 0603	muRata	GRM188R61A684KA61D
C13	1	Capacitor, ceramic, 1 $\mu$ F, 50 V, X7R, $\pm$ 10%, 1210	Panasonic	ECJ-4YB1H105K
C14	1	Capacitor, ceramic, 0.1 $\mu$ F, 50 V, X7R, $\pm$ 10%, 1206	muRata	ECJ-3VB1H104K
C15	1	Capacitor, ceramic, 0.22 $\mu$ F, 16V, X7R, $\pm$ 10%, 0603	muRata	GRM188R71C224KA01D
C16	1	Capacitor, ceramic, 820 pF, 50 V, X7R, $\pm$ 10%, 0603	Kemet	C0603C821K5RACTU
C17	1	Capacitor, ceramic, 3.3 $\mu$ F, 10 V, X5R, $\pm$ 10%, 0805	muRata	GRM219R61A335KE19D
D1	1	Diode, standard recovery, 3 A, 600 V, DO-201AD	Micro Commercial Co.	1N5406-TP
D2	1	Diode, silicon carbide Schottky diode, 4 A, 600 V, TO220AC	Cree	CSD04060A
D3	1	Diode, fast recovery, 1 A, 1000 V, SMB	Diode Inc.	RS1MB-13-F
D4	1	Diode, Schottky, 1 A, 40 V, SOD-123	Micro Commercial Co.	MBRX140-TP
FB1	1	Fuse clip, PC mount, 10 A, 5 x 20 mm	Littelfuse, Inc.	01000056H
F1	1	Fuse, fast acting, ceramic, 8 A, 5 x 20 mm	Bel Fuse Inc.	5HF8-R
HS1	1	Heatsink, 78265 3 B 4250, vertical-mount, 4.25 inches	Aavid Thermalloy	44125
J1	1	Terminal block, 3 pin, 15 A, 5.1 mm	OST	ED1610
J2	1	Terminal block, 2 pin, 15 A, 5.1 mm	OST	ED1609
J3	1	Terminal block, 4 pin, 15 A, 5.1 mm	OST	ED2227
JP1	1	Jumper, 0.200 inch length, PVC insulation, AWG 22	3M	923345-02-C
JP2	1	Jumper, 1.7 inch length, PVC insulation, AWG 22	STD	STD
L1	1	Inductor, PFC boost, 1.25 mH, 7 A, 2.500 Dia.	Vitec	AF4699-111306
L2	1	Inductor, common mode choke, 5 mH, 8.9 A, 22 m $\Omega$	J.W.Miller	8113-RC
Q1	1	MOSFET, N-channel, 650 V, 20.7 A, 190 m $\Omega$ , TO-220V	Infineon Technologies	SPP20N60C3-Q67040-S4398

- (1) These assemblies are ESD sensitive, ESD precautions shall be observed.
- (2) These assemblies must be clean and free from flux and all contaminants. Use of no clean flux is not acceptable.
- (3) These assemblies must comply with workmanship standards IPC-A-610 Class 2.
- (4) Ref designators marked with an asterisk (\*\*\*) cannot be substituted. All other components can be substituted with equivalent MFG's components.

**Table 2. List of Materials (continued)**

R1	1	Resistor, chip, 3.3 $\Omega$ , 1/2 W, $\pm 5\%$ , 2010	Panasonic	ERJ-12ZYJ3R3U
R2, R3, R4	3	Resistor, metal oxide, 0.2 $\Omega$ , 1 W, $\pm 5\%$	RCD Components	RMF1R20JBW
R5	1	Resistor, chip, 10 k $\Omega$ , 1/16 W, $\pm 1\%$ , 0603	Panasonic	ERJ-3EKF1002V
R6	1	Resistor, chip, 221 $\Omega$ , 1/16 W, $\pm 1\%$ , 0603	Panasonic	ERJ-3EKF2210V
R7, R8, R9	3	Resistor, chip, 1.8 M $\Omega$ , 1/10 W, $\pm 1\%$ , 0805	Panasonic	ERJ-6ENF1804V
R10	1	Resistor, chip, 1.1 M $\Omega$ , 1/10 W, $\pm 1\%$ , 0805	Panasonic	ERJ-6ENF1104V
R11	1	Resistor, chip, 49.9 $\Omega$ , 0.25 W, $\pm 1\%$ , 2010	Panasonic	ERJ-8ENF49R9V
R12, R13	2	Resistor, chip, 332 k $\Omega$ , 1/10 W, $\pm 1\%$ , 0603	Panasonic	ERJ-3EKF3323V
R14	1	Resistor, chip, 340 k $\Omega$ , 1/10 W, $\pm 1\%$ , 0603	Panasonic	ERJ-3EKF3403V
R15	0	Resistor, chip, not populated, 1/10 W, $\pm 1\%$ , 0603	STD	not populated
R16	1	Resistor, chip, 33.2 k $\Omega$ , 1/10 W, $\pm 1\%$ , 0603	Vishay/Dale	CRCW060333K2FKEA
R17	1	Resistor, chip, 100 k $\Omega$ , 1/10 W, $\pm 1\%$ , 0603	Panasonic	ERJ-3EKF1003V
R18	1	Resistor, chip, 13 k $\Omega$ , 1/10 W, $\pm 1\%$ , 0603	Panasonic	ERJ-3EKF1302V
RT1	1	Thermistor, NTC, 5 $\Omega$ , 6 A, 0.220 X 0.770 inch	GE	CL-40
U1**	1	Device, Continuous Current Mode PFC Controller, SO8	Texas Instruments	UCC28019D
VAR1	1	Varistor, 430 V, clamping max. 710 V, 25 A, 0.472 x 0.213 inch	GE	S10K275E2
clip	3	Heatsink clips, MAX01G, standard force, T0-220 clips	Aavid Thermalloy	406098
Sil Pad	2	Thermal Pad Silicon TO220 (Electrically Insulating Material) .009" SP400	Bergquist	7403-09FR-58: BER107-ND
Sil Pad	1	Thermal Pad Silicon Rectifier (Electrically Insulating Material) .009" SP400	Bergquist	Q3-46: BER144-ND

## 11 7. References

1. [UCC28019 8-Pin Continuous Conduction Mode \(CCM\) PFC Controller data sheet, TI Literature number SLUS755](#)

## EVALUATION BOARD/KIT IMPORTANT NOTICE

Texas Instruments (TI) provides the enclosed product(s) under the following conditions:

This evaluation board/kit is intended for use for **ENGINEERING DEVELOPMENT, DEMONSTRATION, OR EVALUATION PURPOSES ONLY** and is not considered by TI to be a finished end-product fit for general consumer use. Persons handling the product(s) must have electronics training and observe good engineering practice standards. As such, the goods being provided are not intended to be complete in terms of required design-, marketing-, and/or manufacturing-related protective considerations, including product safety and environmental measures typically found in end products that incorporate such semiconductor components or circuit boards. This evaluation board/kit does not fall within the scope of the European Union directives regarding electromagnetic compatibility, restricted substances (RoHS), recycling (WEEE), FCC, CE or UL, and therefore may not meet the technical requirements of these directives or other related directives.

Should this evaluation board/kit not meet the specifications indicated in the User's Guide, the board/kit may be returned within 30 days from the date of delivery for a full refund. THE FOREGOING WARRANTY IS THE EXCLUSIVE WARRANTY MADE BY SELLER TO BUYER AND IS IN LIEU OF ALL OTHER WARRANTIES, EXPRESSED, IMPLIED, OR STATUTORY, INCLUDING ANY WARRANTY OF MERCHANTABILITY OR FITNESS FOR ANY PARTICULAR PURPOSE.

The user assumes all responsibility and liability for proper and safe handling of the goods. Further, the user indemnifies TI from all claims arising from the handling or use of the goods. Due to the open construction of the product, it is the user's responsibility to take any and all appropriate precautions with regard to electrostatic discharge.

EXCEPT TO THE EXTENT OF THE INDEMNITY SET FORTH ABOVE, NEITHER PARTY SHALL BE LIABLE TO THE OTHER FOR ANY INDIRECT, SPECIAL, INCIDENTAL, OR CONSEQUENTIAL DAMAGES.

TI currently deals with a variety of customers for products, and therefore our arrangement with the user **is not exclusive**.

TI assumes **no liability for applications assistance, customer product design, software performance, or infringement of patents or services described herein**.

Please read the User's Guide and, specifically, the Warnings and Restrictions notice in the User's Guide prior to handling the product. This notice contains important safety information about temperatures and voltages. For additional information on TI's environmental and/or safety programs, please contact the TI application engineer or visit [www.ti.com/esh](http://www.ti.com/esh).

No license is granted under any patent right or other intellectual property right of TI covering or relating to any machine, process, or combination in which such TI products or services might be or are used.

## FCC WARNING

This evaluation board/kit is intended for use for **ENGINEERING DEVELOPMENT, DEMONSTRATION, OR EVALUATION PURPOSES ONLY** and is not considered by TI to be a finished end-product fit for general consumer use. It generates, uses, and can radiate radio frequency energy and has not been tested for compliance with the limits of computing devices pursuant to part 15 of FCC rules, which are designed to provide reasonable protection against radio frequency interference. Operation of this equipment in other environments may cause interference with radio communications, in which case the user at his own expense will be required to take whatever measures may be required to correct this interference.

Mailing Address: Texas Instruments Post Office Box 655303 Dallas, Texas 75265

Copyright © 2007, Texas Instruments Incorporated

## **EVM WARNINGS AND RESTRICTIONS**

It is important to operate this EVM within the input voltage range of 85 VAC to 265 VAC.

Exceeding the specified input range may cause unexpected operation and/or irreversible damage to the EVM. If there are questions concerning the input range, please contact a TI field representative prior to connecting the input power.

Applying loads outside of the specified output range may result in unintended operation and/or possible permanent damage to the EVM. Please consult the EVM User's Guide prior to connecting any load to the EVM output. If there is uncertainty as to the load specification, please contact a TI field representative.

During normal operation, some circuit components may have case temperatures greater than 50°C. The EVM is designed to operate properly with certain components above 50°C as long as the input and output ranges are maintained. These components include but are not limited to linear regulators, switching transistors, pass transistors, and current sense resistors. These types of devices can be identified using the EVM schematic located in the EVM User's Guide. When placing measurement probes near these devices during operation, please be aware that these devices may be very warm to the touch.

### **Mailing Address:**

Texas Instruments  
Post Office Box 655303  
Dallas, Texas 75265

## IMPORTANT NOTICE

Texas Instruments Incorporated and its subsidiaries (TI) reserve the right to make corrections, modifications, enhancements, improvements, and other changes to its products and services at any time and to discontinue any product or service without notice. Customers should obtain the latest relevant information before placing orders and should verify that such information is current and complete. All products are sold subject to TI's terms and conditions of sale supplied at the time of order acknowledgment.

TI warrants performance of its hardware products to the specifications applicable at the time of sale in accordance with TI's standard warranty. Testing and other quality control techniques are used to the extent TI deems necessary to support this warranty. Except where mandated by government requirements, testing of all parameters of each product is not necessarily performed.

TI assumes no liability for applications assistance or customer product design. Customers are responsible for their products and applications using TI components. To minimize the risks associated with customer products and applications, customers should provide adequate design and operating safeguards.

TI does not warrant or represent that any license, either express or implied, is granted under any TI patent right, copyright, mask work right, or other TI intellectual property right relating to any combination, machine, or process in which TI products or services are used. Information published by TI regarding third-party products or services does not constitute a license from TI to use such products or services or a warranty or endorsement thereof. Use of such information may require a license from a third party under the patents or other intellectual property of the third party, or a license from TI under the patents or other intellectual property of TI.

Reproduction of information in TI data books or data sheets is permissible only if reproduction is without alteration and is accompanied by all associated warranties, conditions, limitations, and notices. Reproduction of this information with alteration is an unfair and deceptive business practice. TI is not responsible or liable for such altered documentation.

Resale of TI products or services with statements different from or beyond the parameters stated by TI for that product or service voids all express and any implied warranties for the associated TI product or service and is an unfair and deceptive business practice. TI is not responsible or liable for any such statements.

TI products are not authorized for use in safety-critical applications (such as life support) where a failure of the TI product would reasonably be expected to cause severe personal injury or death, unless officers of the parties have executed an agreement specifically governing such use. Buyers represent that they have all necessary expertise in the safety and regulatory ramifications of their applications, and acknowledge and agree that they are solely responsible for all legal, regulatory and safety-related requirements concerning their products and any use of TI products in such safety-critical applications, notwithstanding any applications-related information or support that may be provided by TI. Further, Buyers must fully indemnify TI and its representatives against any damages arising out of the use of TI products in such safety-critical applications.

TI products are neither designed nor intended for use in military/aerospace applications or environments unless the TI products are specifically designated by TI as military-grade or "enhanced plastic." Only products designated by TI as military-grade meet military specifications. Buyers acknowledge and agree that any such use of TI products which TI has not designated as military-grade is solely at the Buyer's risk, and that they are solely responsible for compliance with all legal and regulatory requirements in connection with such use.

TI products are neither designed nor intended for use in automotive applications or environments unless the specific TI products are designated by TI as compliant with ISO/TS 16949 requirements. Buyers acknowledge and agree that, if they use any non-designated products in automotive applications, TI will not be responsible for any failure to meet such requirements.

Following are URLs where you can obtain information on other Texas Instruments products and application solutions:

<b>Products</b>		<b>Applications</b>	
Amplifiers	<a href="http://amplifier.ti.com">amplifier.ti.com</a>	Audio	<a href="http://www.ti.com/audio">www.ti.com/audio</a>
Data Converters	<a href="http://dataconverter.ti.com">dataconverter.ti.com</a>	Automotive	<a href="http://www.ti.com/automotive">www.ti.com/automotive</a>
DSP	<a href="http://dsp.ti.com">dsp.ti.com</a>	Broadband	<a href="http://www.ti.com/broadband">www.ti.com/broadband</a>
Interface	<a href="http://interface.ti.com">interface.ti.com</a>	Digital Control	<a href="http://www.ti.com/digitalcontrol">www.ti.com/digitalcontrol</a>
Logic	<a href="http://logic.ti.com">logic.ti.com</a>	Military	<a href="http://www.ti.com/military">www.ti.com/military</a>
Power Mgmt	<a href="http://power.ti.com">power.ti.com</a>	Optical Networking	<a href="http://www.ti.com/opticalnetwork">www.ti.com/opticalnetwork</a>
Microcontrollers	<a href="http://microcontroller.ti.com">microcontroller.ti.com</a>	Security	<a href="http://www.ti.com/security">www.ti.com/security</a>
RFID	<a href="http://www.ti-rfid.com">www.ti-rfid.com</a>	Telephony	<a href="http://www.ti.com/telephony">www.ti.com/telephony</a>
Low Power Wireless	<a href="http://www.ti.com/lpw">www.ti.com/lpw</a>	Video & Imaging	<a href="http://www.ti.com/video">www.ti.com/video</a>
		Wireless	<a href="http://www.ti.com/wireless">www.ti.com/wireless</a>

Mailing Address: Texas Instruments, Post Office Box 655303, Dallas, Texas 75265  
Copyright © 2007, Texas Instruments Incorporated