

# 2-Line Chip Style Common Mode Chokes

ChipChoke™ CCMC Series



- Ⓢ Available in 0805 (2012) and 1206 (3216) size
- Ⓢ For USB2.0, 3.0 and other high speed differential signal lines (IEEE1394, LVDS)
- Ⓢ Suppression of common mode noise without attenuating the signal
- Ⓢ Large range of common mode impedance to fit with signal and noise level
- Ⓢ Magnetic shield versions available for lower Rdc and higher current features

## Electrical Specifications @ 25°C - Operating Temperature -40°C to +125°C

Part Number (25%)	Common Mode Impedance @ 100MHz (Ω)	DC Resistance (Ω MAX)	Rated Voltage (Vdc)	Rated Current (mA MAX)	Withstanding Voltage (Vdc)	Insulation Resistance (MΩ MIN)
<b>0805CCMCXTS - Magnetic Shield - 0805 Size</b>						
PE-0805CCMC900STS	90	0.35	50	330	125	10
PE-0805CCMC121STS	120	0.30	50	370	125	10
PE-0805CCMC181STS	180	0.35	50	330	125	10
PE-0805CCMC261STS	260	0.40	50	300	125	10
PE-0805CCMC361STS	360	0.45	50	280	125	10
<b>1206CCMCXTS - Magnetic Shield - 1206 Size</b>						
PE-1206CCMC900STS	90	0.3	50	370	125	10
PE-1206CCMC601STS	600	0.80	50	260	125	10
PE-1206CCMC102STS	1000	1.00	50	230	125	10
PE-1206CCMC222STS	2200	1.20	50	200	125	10

**Notes:**

1. These part numbers are lead free and RoHS compliant. No additional suffix or identifier is required.

## Mechanicals

### 0805 TS, 1206 TS

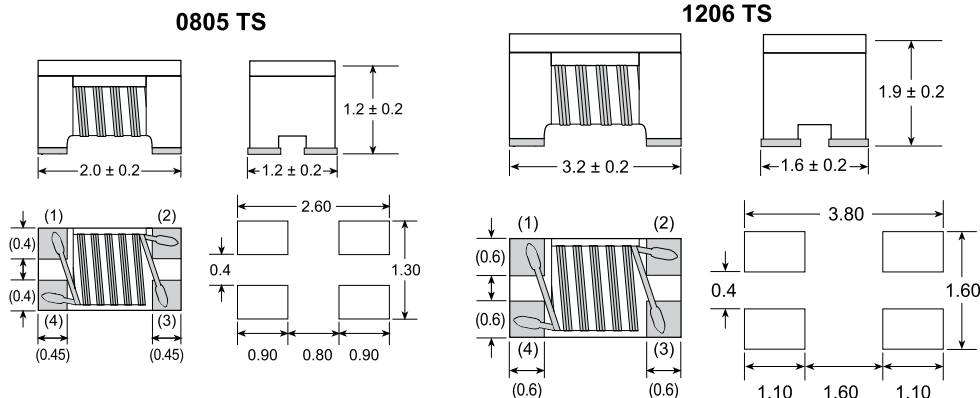

Unit of Measurement: mm

# 2-Line Chip Style Common Mode Chokes

ChipChoke™ CCMC Series

## Impedance vs Frequency

### PE-0805CCMCXXXSTS

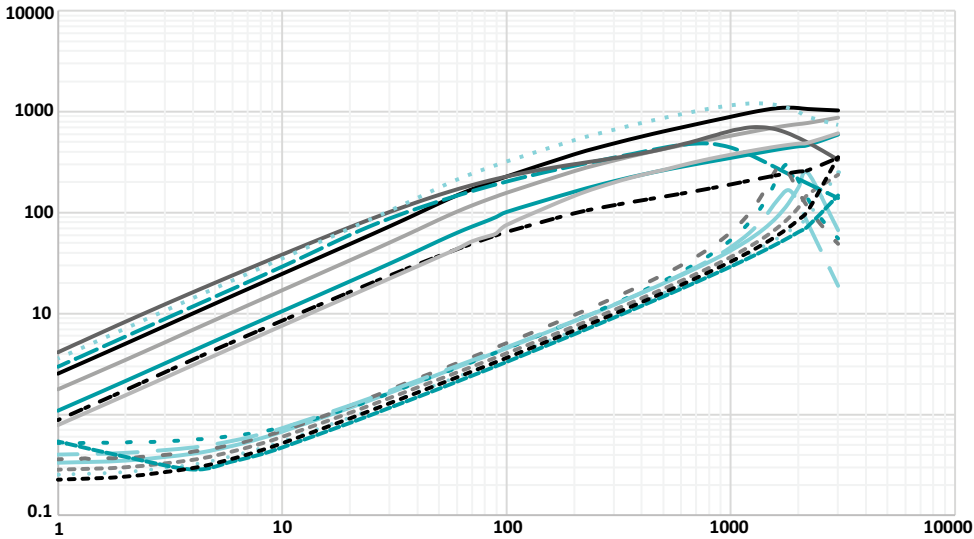

Common Mode	
ITEM	Part Number
	PE-0805CCM900STS
	PE-0805CCM121STS
	PE-0805CCM181STS
	PE-0805CCM261STS
	PE-0805CCM361STS

Differential Mode	
ITEM	Part Number
	PE-0805CCM900STS
	PE-0805CCM121STS
	PE-0805CCM181STS
	PE-0805CCM261STS
	PE-0805CCM361STS

## Impedance vs Frequency

### PE-1206CCMCXXXSTS

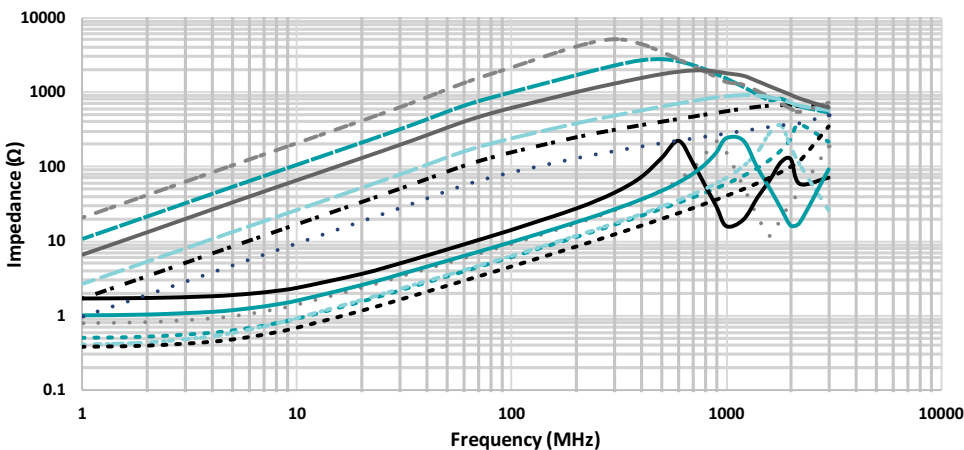

Common Mode	
ITEM	Part Number
	PE-1206CCM900STS
	PE-1206CCM601STS
	PE-1206CCM102STS
	PE-1206CCM222STS

Differential Mode	
ITEM	Part Number
	PE-1206CCM900STS
	PE-1206CCM601STS
	PE-1206CCM102STS
	PE-1206CCM222STS

# 2-Line Chip Style Common Mode Chokes

ChipChoke™ CCMC Series

## Part Number Legend

## Schematics

0805 TS, 1206 TS

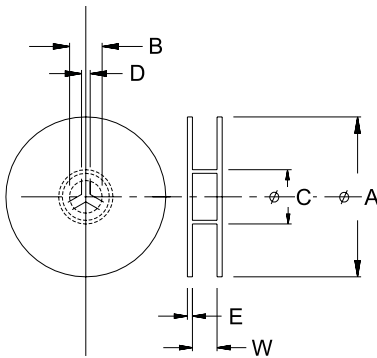
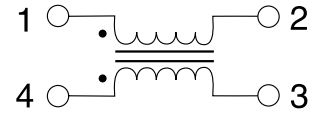
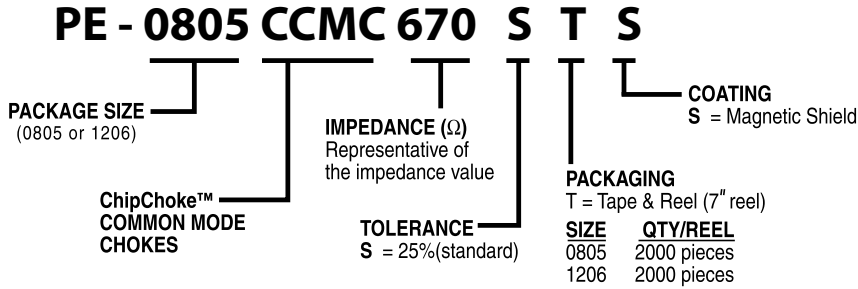

## Tape and Reel Specifications

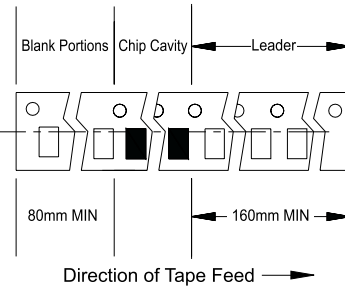
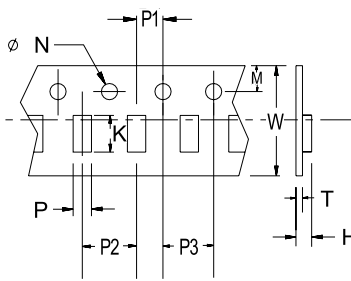

## Packaging Specifications

0805 TS / 1206 TS

Series	Parts per Reel	Reel Dimensions (mm)					Tape Dimensions (mm)									
		A	B	C	D	E	W	P1	P2	P3	H	T	K	M	N	P
0805 TS	2000	178	21	75	2.0	2.5	8.0	2.0	4.0	4.0	1.30	0.3	2.25	1.75	1.5	1.42
1206 TS	2000	178	21	75	2.0	2.5	8.0	2.0	4.0	4.0	2.10	0.2	3.50	1.75	1.5	1.90

## For More Information:

Americas - [prodinfonetworkamericas@pulseelectronics.com](mailto:prodinfonetworkamericas@pulseelectronics.com) | Europe - [comms-apps-europe@pulseelectronics.com](mailto:comms-apps-europe@pulseelectronics.com) | Asia - [prodinfonetworkapac@pulseelectronics.com](mailto:prodinfonetworkapac@pulseelectronics.com)

Performance warranty of products offered on this data sheet is limited to the parameters specified. Data is subject to change without notice. Other brand and product names mentioned herein may be trademarks or registered trademarks of their respective owners. © Copyright, 2020. Pulse Electronics, Inc. All rights reserved.