



RF360
Europe GmbH

Data sheet

SAW filter

Short range devices

Part number:	B3776
Ordering code:	B39871B3776Z810
Date:	July 27, 2020
Version:	2.2

RF360 products mentioned within this document are products of RF360 Europe GmbH and other subsidiaries of RF360 Holdings Singapore Pte. Ltd. (collectively, the "RF360 Subsidiaries").

RF360 Europe GmbH, Anzinger Str. 13, München, Germany

© 2020 RF360 Europe GmbH and/or its affiliated companies. All rights reserved.

These materials, including the information contained herein, may be used only for informational purposes by the customer. The RF360 Subsidiaries assume no responsibility for errors or omissions in these materials or the information contained herein. The RF360 Subsidiaries reserve the right to make changes to the product(s) or information contained herein without notice. The materials and information are provided on an AS IS basis, and the RF360 Subsidiaries assume no liability and make no warranty or representation, either expressed or implied, with respect to the materials, or any output or results based on the use, application, or evaluation of such materials, including, without limitation, with respect to the non-infringement of trademarks, patents, copyrights or any other intellectual property rights or other rights of third parties.

No use of this documentation or any information contained herein grants any license, whether express, implied, by estoppel or otherwise, to any intellectual property rights, including, without limitation, to any patents owned by QUALCOMM Incorporated or any of its subsidiaries.

Not to be used, copied, reproduced, or modified in whole or in part, nor its contents revealed in any manner to others without the express written permission of RF360 Europe GmbH.

Qualcomm is a trademark of Qualcomm Incorporated, registered in the United States and other countries. Other product and brand names may be trademarks or registered trademarks of their respective owners.

This technical data may be subject to U.S. and international export, re-export, or transfer ("export") laws. Diversion contrary to U.S. and international law is strictly prohibited.

Table of contents

1 Application	4
2 Features	4
3 Package	5
4 Pin configuration	5
5 Matching circuit	6
6 Characteristics	8
7 Maximum ratings	10
8 Transmission coefficient	11
9 Packing material	12
10 Marking	14
11 Soldering profile	15
12 ESD protection of SAW filters	16
13 Annotations	17
14 Cautions and warnings	18
15 Important notes	19

1 Application

- Keyless entry: 868.5 MHz (pass band 7 MHz)
- Low-loss RF filter for remote control receivers
- Balanced and unbalanced operation possible

2 Features

- Package size $3.8_{\pm 0.15}$ mm \times $3.8_{\pm 0.15}$ mm
- Package height $1.5_{+0.1/-0.15}$ mm
- Package code QCC8B
- Approximate weight 0.07 g
- RoHS compatible
- Package for Surface Mount Technology (SMT)
- Ni/Au-plated terminals
- Lead free soldering compatible with J-STD20C
- Filter surface passivated
- Electrostatic Sensitive Device (ESD)
- Moisture Sensitivity Level 1 (MSL1)
- AEC-Q200 qualified component family
(Grade 1: -40 °C to $+125$ °C)

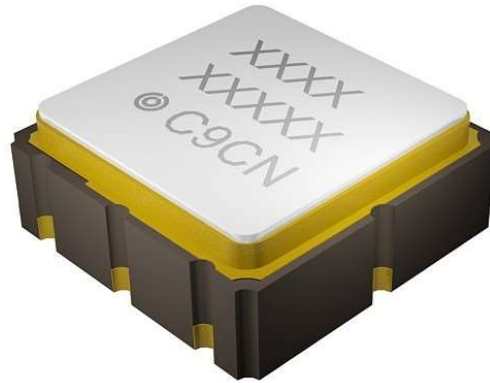
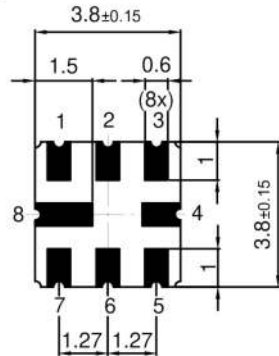

Figure 1: Picture of component with example of product marking.

3 Package

BOTTOM VIEW



SIDE VIEW

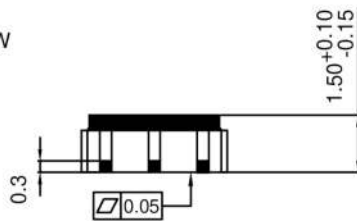

TOP VIEW

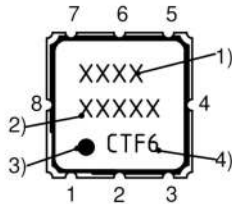

SIDE VIEW



- 1) Device designation
- 2) Last five digits of the lot number
- 3) Marking for pad number 1
- 4) Example of production location and date code

Land pattern
THRU VIEW

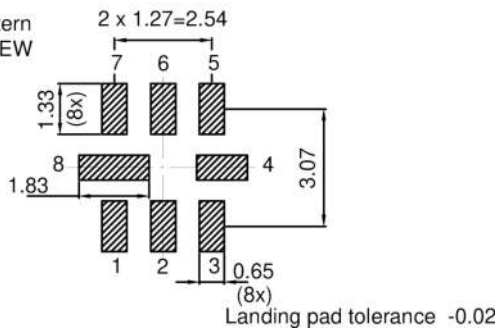

Figure 2: Drawing of package. See Sec. Package information (p. 17).

4 Pin configuration

- 2 Input (recommend or ground)
- 5 Output (recommend or ground)
- 1 Ground (recommend or input)
- 3, 4, 7, 8 Ground
- 6 Ground (recommend or output)

5 Matching circuit

- $C_{p2b} = 2.7 \text{ pF}$
- $C_{p5b} = 2.7 \text{ pF}$
- $L_{s2a} = 22 \text{ nH}$
- $L_{s5a} = 22 \text{ nH}$

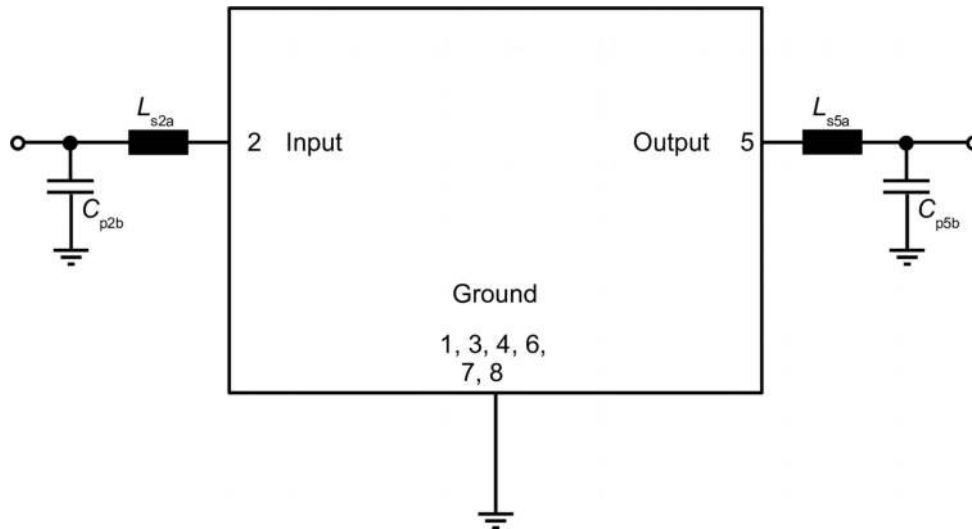

Figure 3: Schematic of matching circuit.

Minimising the crosstalk

For a good ultimate rejection a low crosstalk is necessary. Low crosstalk can be realised with a good RF layout. The major crosstalk mechanism is caused by the “ground-loop” problem.

Grounding loops are created if input- and output transducer GND are connected on the top-side of the PCB and fed to the system grounding plane by a common via hole. To avoid the common ground path, the ground pin of the input- and output transducer are fed to the system ground plane (bottom PCB plane) by their own via hole. The transducers’ grounding pins should be isolated from the upper grounding plane.

A common GND inductivity of 0.5 nH degrades the ultimate rejection (crosstalk) by 20 dB.

The optimised PCB layout, including matching network for transformation to 50 Ohm, is shown here. In this PCB layout the grounding loops are minimised to realise good ultimate rejection.

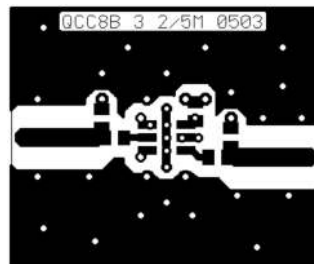

Figure 4: Optimised PCB layout for SAW filters in QCC8B package, pinning 2,5 (top side, scale 1:1).

The bottom side is a copper plane (system ground area). The input and output grounding pins are isolated and connected to the common ground by separated via holes.

For good contact of the upper grounding area with the lower side it is necessary to place enough via holes.

6 Characteristics

Temperature	T_{SPEC}	= +25 °C
Input terminating impedance	Z_{IN}	= 50 Ω with ext. circuitry. ¹⁾
Output terminating impedance	Z_{OUT}	= 50 Ω with ext. circuitry. ¹⁾

Characteristics				min. for T_{SPEC}	typ. @ +25 °C	max. for T_{SPEC}	
Center frequency			f_C	—	868.3	—	MHz
Minimum insertion attenuation			α_{min}				
Incl. loss in matching elements ($Q_L=57$)				—	3.6	4.2	dB
Excl. loss in matching elements				—	2.7	3.3	dB
Maximum insertion attenuation			α_{max}				
Incl. loss in matching elements ($Q_L=57$)	868.15 ... 868.45	MHz		—	4.1	5.1	dB
Excl. loss in matching elements				—	3.2	4.2	dB
Minimum attenuation (relative to α_{min})			$\alpha_{rel,min}$				
	10 ... 620	MHz		48	53	—	dB
	620 ... 680	MHz		40	44	—	dB
	680 ... 855	MHz		48	52	—	dB
	855 ... 864	MHz		25	29	—	dB
	864 ... 867.2	MHz		17	20	—	dB
	867.2 ... 867.6	MHz		11	20	—	dB
	867.6 ... 867.9	MHz		—	3	—	dB
	869.5 ... 876	MHz		12	15	—	dB
	876 ... 883	MHz		32	37	—	dB
	883 ... 900	MHz		45	50	—	dB
	900 ... 1500	MHz		50	55	—	dB
Impedance for pass band matching							
@ input port: $Z_{in,IN} = R_{IN} \parallel C_{IN}$			$Z_{in,IN}$ ²⁾	—	450 0.9	—	$\Omega \parallel \text{pF}$
@ output port: $Z_{in,OUT} = R_{OUT} \parallel C_{OUT}$			$Z_{in,OUT}$ ²⁾	—	450 0.9	—	$\Omega \parallel \text{pF}$

¹⁾ See Sec. Matching circuit (p. 6).

²⁾ Impedance for pass band matching bases on an ideal, perfect matching of the SAW filter to source and to load impedance (here 50 Ω). After removal of the SAW filter the input impedance of the input and output matching network is calculated. The conjugate complex value of these characteristic impedances are the input and output impedances for flat pass band. For more details we refer to RF360 application note #18.

Temperature range for specification	T_{SPEC}	= -40 °C ... +105 °C
Input terminating impedance	Z_{IN}	= 50 Ω with ext. circuitry. ¹⁾
Output terminating impedance	Z_{OUT}	= 50 Ω with ext. circuitry. ¹⁾

Characteristics				min. for T_{SPEC}	typ. @ +25 °C	max. for T_{SPEC}	
Center frequency			f_C	—	868.3	—	MHz
Minimum insertion attenuation			α_{min}				
Incl. loss in matching elements ($Q_L=57$)				—	3.6	4.3	dB
Excl. loss in matching elements				—	2.7	3.4	dB
Maximum insertion attenuation			α_{max}				
Incl. loss in matching elements ($Q_L=57$)	868.15 ... 868.45	MHz		—	4.1	5.2	dB
Excl. loss in matching elements				—	3.2	4.3	dB
Minimum attenuation (relative to α_{min})			$\alpha_{rel,min}$				
	10 ... 620	MHz		48	53	—	dB
	620 ... 680	MHz		40	44	—	dB
	680 ... 855	MHz		48	52	—	dB
	855 ... 864	MHz		25	29	—	dB
	864 ... 867.2	MHz		17	20	—	dB
	867.2 ... 867.6	MHz		2	20	—	dB
	869.5 ... 876	MHz		12	15	—	dB
	876 ... 883	MHz		32	37	—	dB
	883 ... 900	MHz		45	50	—	dB
	900 ... 1500	MHz		50	55	—	dB
Impedance for pass band matching							
@ input port: $Z_{in,IN} = R_{IN} \parallel C_{IN}$			$Z_{in,IN}$ ²⁾	—	450 0.9	—	$\Omega \parallel \text{pF}$
@ output port: $Z_{in,OUT} = R_{OUT} \parallel C_{OUT}$			$Z_{in,OUT}$ ²⁾	—	450 0.9	—	$\Omega \parallel \text{pF}$

¹⁾ See Sec. Matching circuit (p. 6).

²⁾ Impedance for pass band matching bases on an ideal, perfect matching of the SAW filter to source and to load impedance (here 50 Ω). After removal of the SAW filter the input impedance of the input and output matching network is calculated. The conjugate complex value of these characteristic impedances are the input and output impedances for flat pass band. For more details we refer to RF360 application note #18.

7 Maximum ratings

Operable temperature	$T_{OP} = -45\text{ °C} \dots +125\text{ °C}$	
Storage temperature	$T_{STG}^{1)} = -45\text{ °C} \dots +125\text{ °C}$	
DC voltage	$ V_{DC} = 6.0\text{ V (max.)}$	
Source power	$P_S = 10\text{ dBm}$	Source impedance 50 Ω.

¹⁾ Not valid for packaging material. Please refer to definition of Shelf life (p. 16).

8 Transmission coefficient

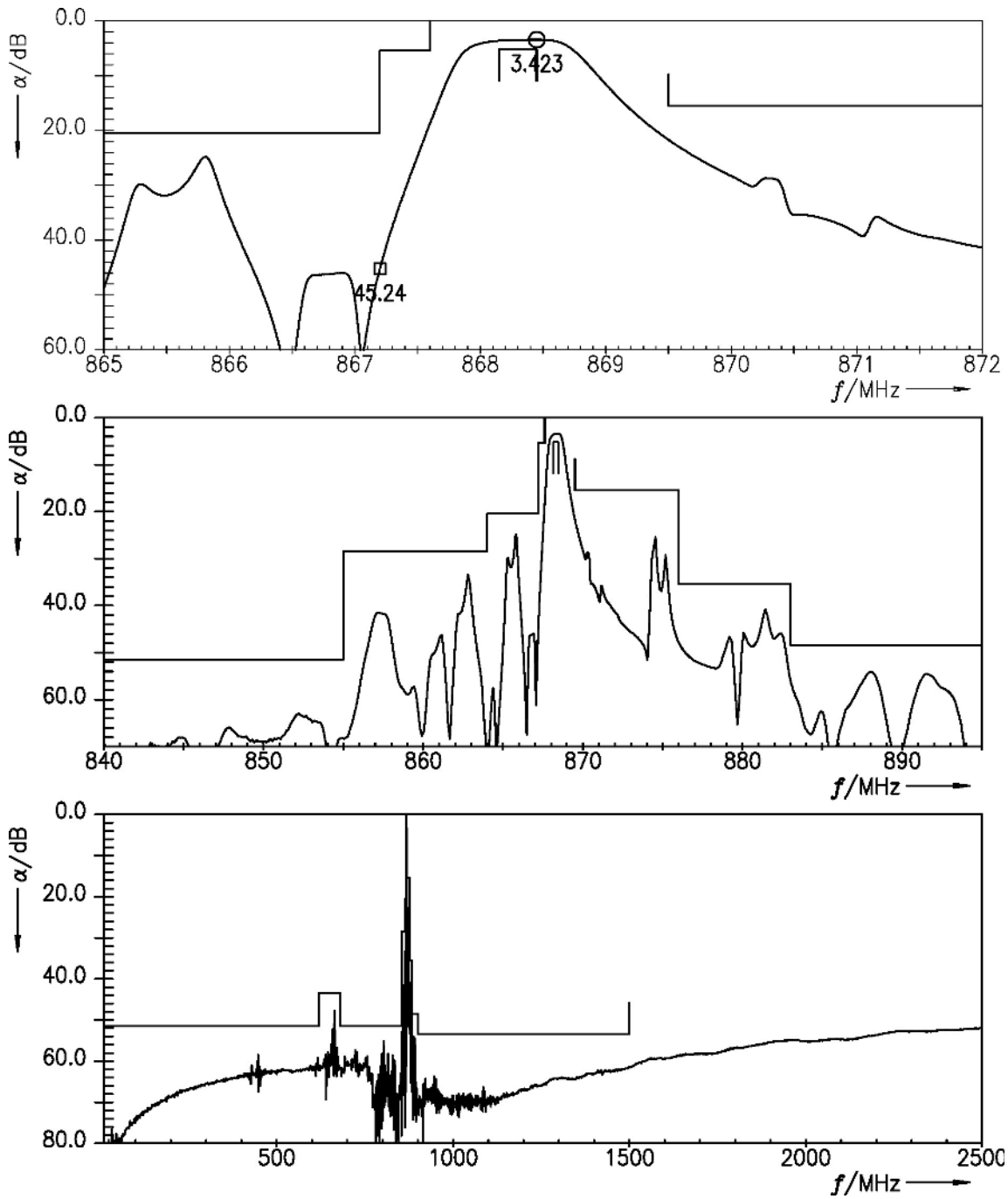

Figure 5: Attenuation.

9 Packing material

9.1 Tape

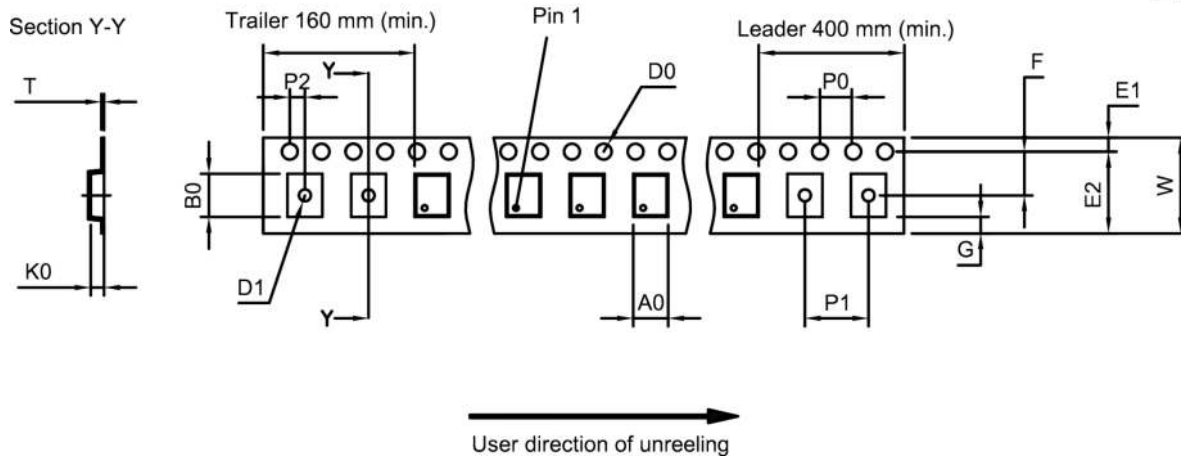

Figure 6: Drawing of tape (first-angle projection) for illustration only and not to scale. The valid tape dimensions are listed in Table 1.

A_0	4.1±0.1 mm	E_2	10.25 mm (min.)	P_1	8.0±0.1 mm
B_0	4.1±0.1 mm	F	5.5±0.05 mm	P_2	2.0±0.1 mm
D_0	1.5+0.1/-0 mm	G	0.75 mm (min.)	T	0.3±0.05 mm
D_1	1.5 mm (min.)	K_0	1.8±0.1 mm	W	12.0+0.3/-0.1 mm
E_1	1.75±0.1 mm	P_0	4.0±0.1 mm		

Table 1: Tape dimensions.

9.2 Reel with diameter of 330 mm

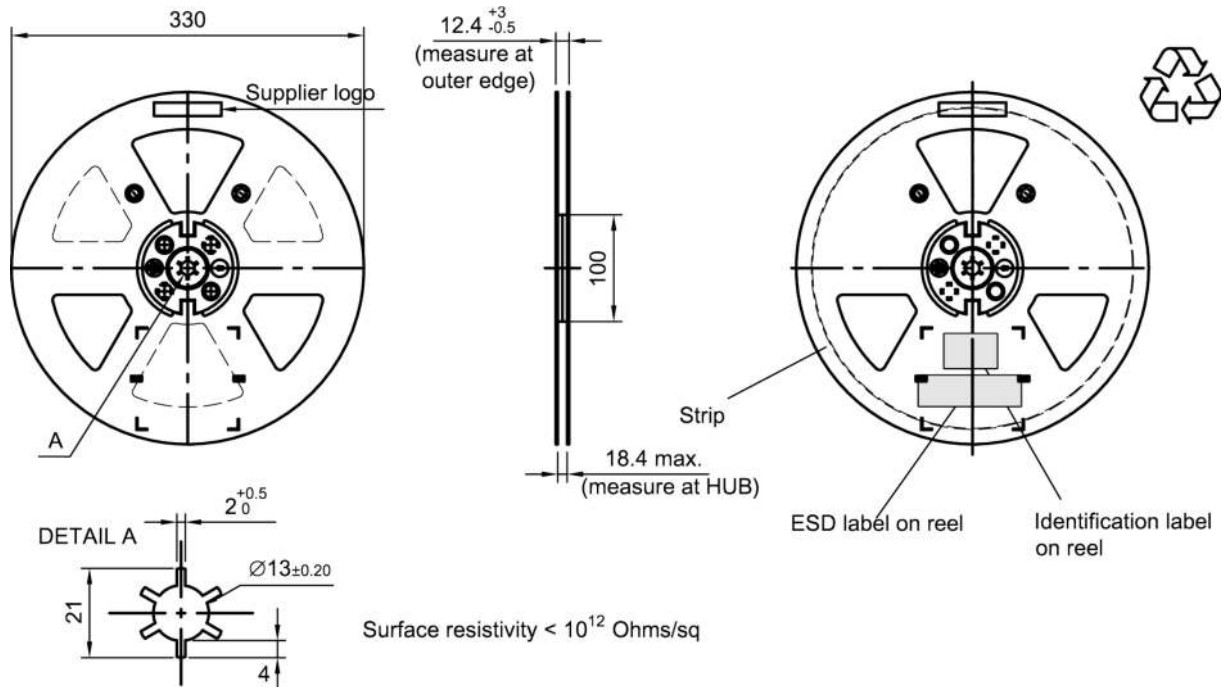
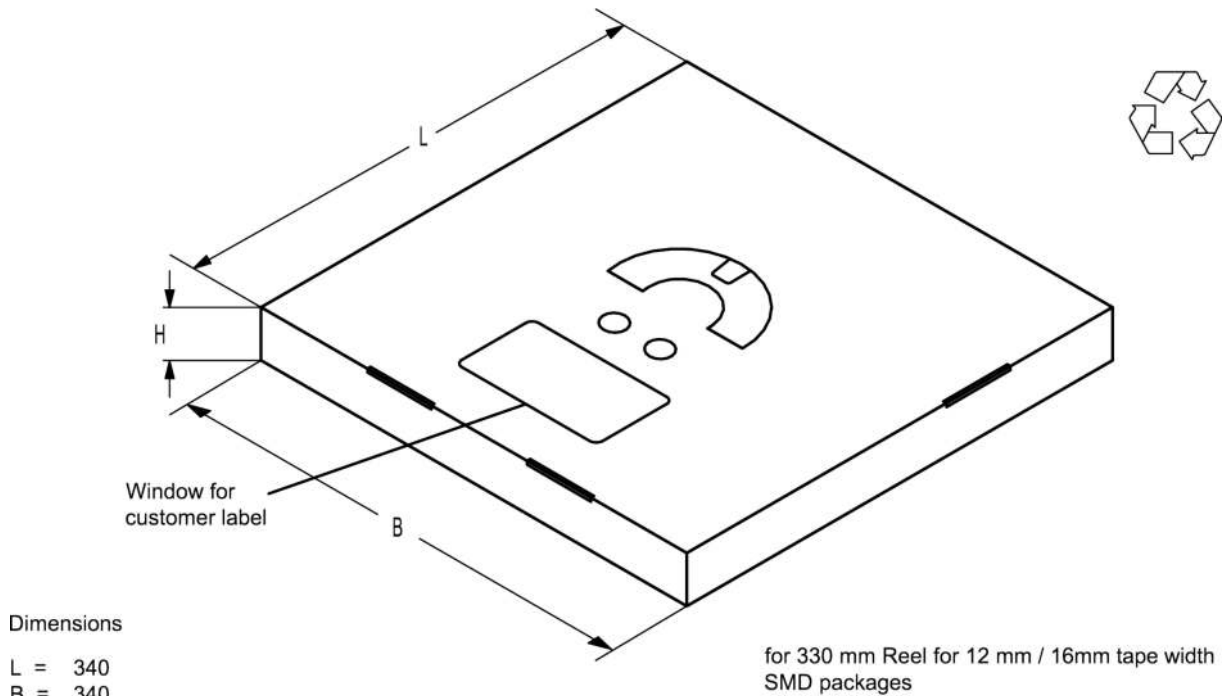

Figure 7: Drawing of reel (first-angle projection) with diameter of 330 mm.



Dimensions

- L = 340
- B = 340
- H = 25

for 330 mm Reel for 12 mm / 16mm tape width SMD packages

Figure 8: Drawing of folding box for reel with diameter of 330 mm.

10 Marking

Products are marked with device designation, lot number, as well as production location and date code.

- Device designation: The 4-character device designation of the ordering code is used for the marking.

Example for 4-character device designation: B3xxxxB**1234**xxxx

- Lot number: The last 5 digits of the lot number are used for the marking.

Example: **12345**

- Production location and date code: The production location is Wuxi (encoded in the first character 'C'). The production date code is encoded in the last three characters according to Table 2.

1 st digit (day)						2 nd digit (year)				3 rd digit (month)			
Day	Code	Day	Code	Day	Code	Year	Code	Year	Code	Month	Code	Month	Code
1	1	11	A	21	M	2010	A	2022	P	Jan	1	Jul	7
2	2	12	B	22	N	2011	B	2023	R	Feb	2	Aug	8
3	3	13	C	23	P	2012	C	2024	S	Mar	3	Sep	9
4	4	14	D	24	R	2013	D	2025	T	Apr	4	Oct	0
5	5	15	E	25	S	2014	E	2026	U	May	5	Nov	N
6	6	16	F	26	T	2015	F	2027	V	Jun	6	Dec	D
7	7	17	H	27	U	2016	H	2028	W				
8	8	18	J	28	V	2017	J	2029	X				
9	9	19	K	29	W	2018	K	2030	Z				
10	0	20	L	30	X	2019	L	2031	A				
				31	Z	2020	M	2032	B				
						2021	N	and so on					

Table 2: Production date code.

Example of how to decode production location and date code:

Code: **C T F 6**

Location: C → Wuxi

Day: T → 26th

Year: F → 2015

Month: 6 → June

11 Soldering profile

The recommended soldering process is in accordance with IEC 60068-2-58 – 3rd edit and IPC/JEDEC J-STD-020B.

ramp rate	≤ 3 K/s
preheat	125 °C to 220 °C, 150 s to 210 s, 0.4 K/s to 1.0 K/s
$T > 220\text{ °C}$	30 s to 70 s
$T > 230\text{ °C}$	min. 10 s
$T > 245\text{ °C}$	max. 20 s
$T \geq 255\text{ °C}$	–
peak temperature T_{peak}	250 °C +0/-5 °C
wetting temperature T_{min}	230 °C +5/-0 °C for 10 s ± 1 s
cooling rate	≤ 3 K/s
soldering temperature T	measured at solder pads

Table 3: Characteristics of recommended soldering profile for lead-free solder (Sn95.5Ag3.8Cu0.7).

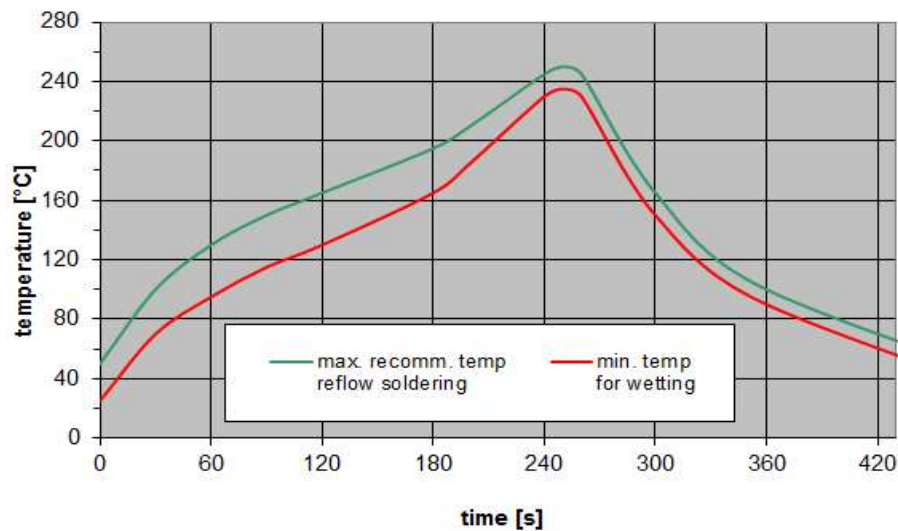

Figure 9: Recommended reflow profile for convection and infrared soldering – lead-free solder.

12 ESD protection of SAW filters

SAW filters are **E**lectro **S**tatic **D**ischarge sensitive devices. To reduce the probability of damages caused by ESD, special matching topologies have to be applied.

In general, “ESD matching” has to be ensured at that filter port, where electrostatic discharge is expected.

Electrostatic discharges predominantly appear at the antenna input of RF receivers. Therefore, only the input matching of the SAW filter has to be designed to short circuit or to block the ESD pulse.

Below four figures show recommended “ESD matching” topologies.

Depending on the input impedance of the SAW filter and the source impedance, the needed component values have to be determined from case to case.

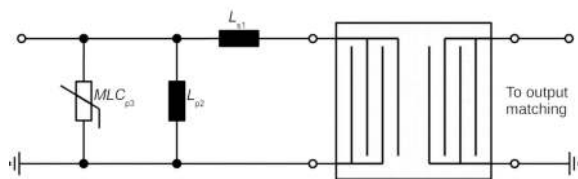

Figure 10: MLC varistor plus ESD matching.

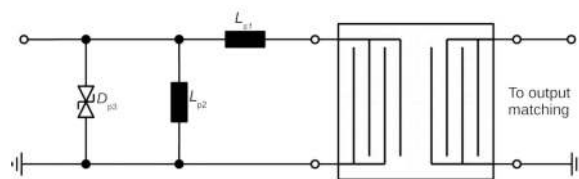

Figure 11: Suppressor diode plus ESD matching.

In cases where minor ESD occur, following simplified “ESD matching” topologies can be used alternatively.

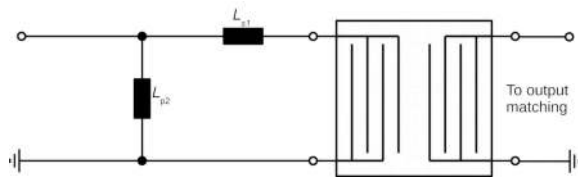

Figure 12: shunt L - series L matching.

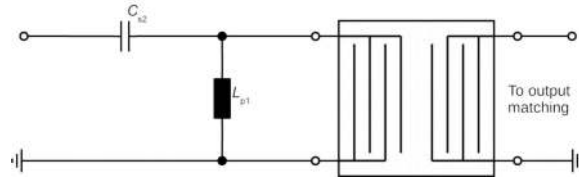

Figure 13: series C - shunt L matching.

Effectiveness of the applied ESD protection has to be checked according to relevant industry standards or customer specific requirements.

For further information, please refer to RF360 Application report: “**ESD protection for SAW filters**”. This report can be found under <https://rfe.qualcomm.com>.

13 Annotations

13.1 RoHS compatibility

ROHS-compatible means that products are compatible with the requirements according to Art. 4 (substance restrictions) of Directive 2011/65/EU of the European Parliament and of the Council of June 8th, 2011, on the restriction of the use of certain hazardous substances in electrical and electronic equipment ("Directive") with due regard to the application of exemptions as per Annex III of the Directive in certain cases.

13.2 Scattering parameters (S-parameters)

The pin/port assignment is available in the headers of the S-parameter files. Please contact your local RF360 sales office.

13.3 Shelf life

The shelf life of components is determined by solderability of the package terminals. It is specified as 2 years from manufacturing date assuming the following conditions:

- storage in original packaging and non-aggressive atmosphere,
- storage temperature ranging from -25 °C to $+40\text{ °C}$, and
- storage humidity with $\leq 75\%$ r.h. mean annual humidity, $\leq 95\%$ r.h. for max. 30 days / year, and no dew condensation.

14 Cautions and warnings

14.1 Display of ordering codes for RF360 products

The ordering code for one and the same product can be represented differently in data sheets, data books, other publications and the website of RF360, or in order-related documents such as shipping notes, order confirmations and product labels. The varying representations of the ordering codes are due to different processes employed and do not affect the specifications of the respective products. Detailed information can be found on the Internet under <https://rfe.qualcomm.com/>.

14.2 Material information

Due to technical requirements components may contain dangerous substances. For information on the type in question please also contact one of our sales offices.

For information on recycling of tapes and reels please contact one of our sales offices.

14.3 Moldability

Before using in overmolding environment, please contact your local RF360 sales office.

14.4 Package information

Landing area

The printed circuit board (PCB) land pattern (landing area) shown is based on RF360 internal development and empirical data and illustrated for example purposes, only. As customers' SMD assembly processes may have a plenty of variants and influence factors which are not under control or knowledge of RF360, additional careful process development on customer side is necessary and strongly recommended in order to achieve best soldering results tailored to the particular customer needs.

Dimensions

Unless otherwise specified all dimensions are understood using unit millimeter (mm).

Projection method

Unless otherwise specified first-angle projection is applied.

15 Important notes

The following applies to all products named in this publication:

1. Some parts of this publication contain **statements about the suitability of our products for certain areas of application**. These statements are based on our knowledge of typical requirements that are often placed on our products in the areas of application concerned. We nevertheless expressly point out **that such statements cannot be regarded as binding statements about the suitability of our products for a particular customer application**. As a rule, RF360 Europe GmbH and its affiliates are either unfamiliar with individual customer applications or less familiar with them than the customers themselves. For these reasons, it is always ultimately incumbent on the customer to check and decide whether an RF360 product with the properties described in the product specification is suitable for use in a particular customer application.
2. We also point out that **in individual cases, a malfunction of electronic components or failure before the end of their usual service life cannot be completely ruled out in the current state of the art, even if they are operated as specified**. In customer applications requiring a very high level of operational safety and especially in customer applications in which the malfunction or failure of an electronic component could endanger human life or health (e.g. in accident prevention or life-saving systems), it must therefore be ensured by means of suitable design of the customer application or other action taken by the customer (e.g. installation of protective circuitry or redundancy) that no injury or damage is sustained by third parties in the event of malfunction or failure of an electronic component.
3. **The warnings, cautions and product-specific notes must be observed.**
4. In order to satisfy certain technical requirements, **some of the products described in this publication may contain substances subject to restrictions in certain jurisdictions (e.g. because they are classed as hazardous)**. Useful information on this will be found in our Material Data Sheets on the Internet (<https://rffe.qualcomm.com>). Should you have any more detailed questions, please contact our sales offices.
5. We constantly strive to improve our products. Consequently, **the products described in this publication may change from time to time**. The same is true of the corresponding product specifications. Please check therefore to what extent product descriptions and specifications contained in this publication are still applicable before or when you place an order. We also **reserve the right to discontinue production and delivery of products**. Consequently, we cannot guarantee that all products named in this publication will always be available.
The aforementioned does not apply in the case of individual agreements deviating from the foregoing for customer-specific products.