

# LED Driver

## USVI S24 Series

# USVI S24

### Highlights & Features

- Constant voltage design
- Universal input voltage from 120-277Vac
- Multi-Channel output and independent operating
- Class 2 output
- Wide operating temperature range -40°C to +55°C
- Dry & Damp location rated for signage application



### Safety Standards



### Dimensions (L x W x D):

USVI-020024FA	5.20 x 1.34 x 1.00 inch (132.0 x 34.1 x 25.4 mm)
USVI-060024FG	5.83 x 1.80 x 1.00 inch (148.2 x 45.6 x 25.4 mm)
USVI-060024DG	5.83 x 1.80 x 1.00 inch (148.2 x 45.6 x 25.4 mm)
USVI-060024FH	9.50 x 1.70 x 1.18 inch (241.3 x 43.1 x 30.0 mm)
USVI-100024FE/G	9.50 x 1.70 x 1.00 inch (241.3 x 43.1 x 25.4 mm)
USVI-100024DE/G	9.50 x 1.70 x 1.00 inch (241.3 x 43.1 x 25.4 mm)
USVI-100024FH	9.50 x 1.70 x 1.18 inch (241.3 x 43.1 x 30.0 mm)
USVI-200024FA	16.70 x 1.70 x 1.18 inch (424.2 x 43.1 x 30.0 mm)

### General Description

Delta USVI S24 series of fixed output voltage LED drivers comes with affordable and reliable features. Compatible with signage from any manufacturer. 24V major output voltage with 1 or 2 multi-channel selection for different lumen application. Meet North America safety certifications, and compliant with FCC Immunity/Emissions/Harmonic requirements. The products are designed and rigorously tested to work in various indoor/signage LED lighting conditions.

### Model Information

Model Number	Input Voltage Range	Rated Output Voltage	Rated Output Current	Output Channels
USVI-020024FA	90 - 305Vac  108 - 305Vac	24Vdc	0.85A, 0.85A/ Channel	1
USVI-060024FG			2.50A, 2.50A/ Channel	1
USVI-060024DG			2.50A, 2.50A/ Channel	1
USVI-060024FH			2.50A, 2.50A/ Channel	1
USVI-100024FE/G			4.15A, 4.15A/ Channel	1
USVI-100024DE/G			4.15A, 4.15A/ Channel	1
USVI-100024FH			4.00A, 4.00A/ Channel	1
USVI-200024FA			8.00A, 4.00A/ Channel	2

### Model Numbering

US	V	I	-	□□□	□□□	□	□
Safety Approval cULus CSA CE	Constant Voltage	Indoor		Output Power 020 – 20W 060 – 60W 100 – 100W 200 – 200W	Output Voltage 024 – 24Vdc	Function D – 0-10V Dimming F – Fixed Output	Variable

# LED Driver

## USVI S24 Series

### Specifications

Model Number	USVI-020024FA	USVI-060024DG	USVI-060024FG	USVI-060024FH
--------------	---------------	---------------	---------------	---------------

### Input Ratings / Characteristics

Normal Input Voltage	100-277Vac	120-277Vac	120-277Vac	120-277Vac	
Input Voltage Range	90-305Vac	108-305Vac	108-305Vac	108-305Vac	
Normal Input Frequency	50-60 Hz	50-60 Hz	50-60 Hz	50-60 Hz	
Input Frequency Range	47-63 Hz	47-63 Hz	47-63 Hz	47-63 Hz	
Input Current Max	0.27A	0.58A	0.58A	0.59A	
Efficiency <sup>1)</sup>	277Vac	80.0% typ.	90.0% typ.	90.0% typ.	87.0% typ.
Inrush Current Peak >50% Duration	32A/ 150us	70A/ 250us	70A/ 250us	50A/ 250us	
Power Factor @ max. Load.	> 0.9	> 0.95	> 0.95	> 0.95	
Total Harmonic Distortion @ max. Load.	< 20%				
Leakage Current	< 0.75mA @ 277Vac				

1) 100% Load (typical) and tested after 30 minutes warm up.

### Output Ratings / Characteristics

Nominal Output Voltage (per channel)	24Vdc			
Max. No Load Output Voltage (per channel)	25.2Vdc			
Output Current Range (per channel)	0.05A – 0.83A	0.10A – 2.50A	0.10A – 2.50A	0.10A – 2.50A
Max. Output Power (per channel)	20W	60W	60W	60W
Output Channel	1			
Max. Output Power (total output)	20W	60W	60W	60W
Output Voltage Tolerance	± 3%			
Line Regulation	± 1%			
Load Regulation	± 3%			
Output Ripple Voltage	< 720mVp-p	< 500mVp-p	< 500mVp-p	<400mVp-p
Rise Time	< 50ms			
Start-up Time	< 1s			

### Dimming Characteristics (For DE and DG model only)

Dimming Method	0 ~ 10Vdc for 0 ~100%. Internal PWM Dimming (1kHz). Source current is 120uA. 1) 1V (5%) – 9V (100%) 2) Dimming terminal Open (100%) 3) Dimming terminal Short (0%) 4) Dim= 0.4V OFF
----------------	---

# LED Driver

## USVI S24 Series

Model Number	USVI-020024FA	USVI-060024DG	USVI-060024FG	USVI-060024FH
--------------	---------------	---------------	---------------	---------------

### Mechanical

Casing		Plastic, Color: White	Metal sheet, Color: White	Metal sheet, Color: White	Metal sheet, Color: White
Dimensions (L x W x H)	[inch] [mm]	5.20*1.34*1.00 132.0*34.0*25.4	5.83 x 1.80 x 1.00 148.2 x 45.6 x 25.4	5.83 x 1.80 x 1.00 148.2 x 45.6 x 25.4	9.50 x 1.70 x 1.18 241.3 x 43.1 x 30.0
Unit Weight	[lbs] [kg]	0.40 0.18	0.75 0.34	0.75 0.34	1.32 0.60
Cooling System		Convection			
Input Wire		Line: Black, Neutral: White, Wire Length 300mm			
Output Wire		Positive: Red, Negative: Blue, Wires Length 300mm	Dim+: Violet, Dim-: Gray, Positive: Red, Negative: Blue, Wires Length 300mm	Positive: Red, Negative: Blue, Wires Length 300mm	Positive: Red, Negative: Black, Wires Length 300mm
Noise (30cm distance)		Sound Pressure Level (SPL) < 24dBA			

### Environment

Ambient Temperature	Operating	-40°C to +60°C	-40°C to +55°C	-40°C to +55°C	-40°C to +55°C
	Storage	-40°C to +85°C			
Case Temperature (for UL)		+90°C	+90°C	+90°C	+85°C
Case Temperature (for warranty)		+70°C	+80°C	+80°C	+75°C
Relative Humidity	Operating	10 to 90% RH (Non-Condensing)			
	Storage	5 to 95% RH (Non-Condensing)			
Environmental Locations		UL Dry & Damp			

### Protections

Over Voltage	Auto-Recovery when the fault is removed
Overload / Overcurrent	Auto-Recovery when the fault is removed
Short Circuit	Auto-Recovery when the fault is removed
Over Temperature	Auto-Recovery when the fault is removed
Suitable for Luminaires Class	Class II. Insulation Class according to IEC 60598

### Reliability Data

Lifetime	50,000 hrs. at lifetime case temperature
MTTF	500,000 hrs. @ 40°C ambient temperature (as per Telcordia SR-332, survival rate more than 90%)

# LED Driver

## USVI S24 Series

<b>Model Number</b>	USVI-020024FA*	USVI-060024DG	USVI-060024FG	USVI-060024FH
---------------------	----------------	---------------	---------------	---------------

### Safety Standards / Directives

Electrical Safety	cULus	UL 8750, Class P, type "HL". Class 2 Output			
	CSA	N/A			CAN/CSA C22.2 No.250.13
	CB scheme	IEC 61347-1, IEC 61347-2-13, SELV Output			
CE		In conformance with EMC Directive 2014/30/EU and Low Voltage Directive 2014/35/EU			
Material and Parts		RoHS Directive Compliant			
Isolation		Input	Output	DIM ±	Case
	Input	N/A	3000V	3000V	3000V
	Output	3000V	N/A	N/A	500V
	DIM ±	3000V	N/A	N/A	500V
	Case	3000V	500V	500V	N/A

\* cULus recognized ( does not include Class P certification)

### EMC

#### USVI-060024DG / USVI-060024FG

Emissions	Compliance to 47 CFR FCC Part 15, Subpart B, Class B	
Surge	ANSI C62.41	Category A1 with a 2.5kV/100kA ring wave

#### USVI-060024FH

Emissions	Compliance to 47 CFR FCC Part 15, Subpart B, Class A	
Surge	ANSI C62.41	Category A1 with a 2.5kV/100kA ring wave

# LED Driver

## USVI S24 Series

## EMC (CE &amp; RE)

## USVI-020024FA / USVI-060024DG / USVI-060024FG/ USVI-060024FH

Emissions	Compliance to EN 55015	
Immunity	Compliance to EN 61547	
Electrostatic Discharge	IEC 61000-4-2	Air Discharge: 8kV; Contact Discharge: 4kV Criteria A <sup>1)</sup> or B <sup>2)</sup>
Radiated Disturbance	IEC 61000-4-3	80MHz-1GHz, 3V/m with 1kHz Sine Wave / 80% AM Modulation Criteria A <sup>1)</sup>
Electrical Fast Transient / Burst	IEC 61000-4-4	1kV, Criteria A <sup>1)</sup> or B <sup>2)</sup>
Surge	IEC 61000-4-5	Common Mode <sup>3)</sup> : 4kV; Differential Mode <sup>4)</sup> : 2kV for USVI-060024DG/FG Common Mode <sup>3)</sup> : 1kV; Differential Mode <sup>4)</sup> : 1kV for USVI-020024FA 1.2/50 $\mu$ s, 8/20 $\mu$ s Combination Wave with 2ohms (L-N), 12ohms (L-PE & N-PE) source impedance Criteria A <sup>1)</sup> or B <sup>2)</sup>
Conducted Disturbance	IEC 61000-4-6	150kHz-80MHz, 3Vrms, Criteria A <sup>1)</sup>
Power Frequency Magnetic Fields	IEC 61000-4-8	3A/Meter, Criteria A <sup>1)</sup>
Voltage Dips	IEC 61000-4-11	100% dip; 0.5 cycle; Self Recoverable 30% dip; 10 cycle; Self Recoverable, Criteria A <sup>1)</sup> or B <sup>2)</sup>
Harmonic Current Emission	IEC 61000-3-2	Class C (230Vac @ 100% load)
Voltage Fluctuation and Flicker	IEC 61000-3-3	$P_{st} \leq 1.0$ ; $d_{max} \leq 4\%$ ; $P_{It} \leq 0.65$ ; $d_c \leq 3.3\%$ ; $T_{max} \leq 500ms$

1) Criteria A: Normal performance within the specification limits

2) Criteria B: Temporary degradation or loss of function, which is self-recoverable

3) Asymmetrical: Common mode (Line to earth)

4) Symmetrical: Differential mode (Line to line)

# LED Driver

## USVI S24 Series

### Specifications

Model Number	USVI-100024DG	USVI-100024FG	USVI-100024DE	USVI-100024FE	USVI-100024FH	USVI-200024FA
--------------	---------------	---------------	---------------	---------------	---------------	---------------

### Input Ratings / Characteristics

Normal Input Voltage	120-277Vac						
Input Voltage Range	108-305Vac						
Normal Input Frequency	50-60 Hz						
Input Frequency Range	47-63 Hz						
Input Current Max	0.95A			0.91A		1.83A	
Efficiency <sup>1)</sup>	277Vac	89.5% typ.	89.5% typ.	89.5% typ.	89.5% typ.	90.0% typ.	90.5% typ.
Inrush Current Peak >50% Duration	150A/ 250us				70A / 200uS	170A / 110uS	
Power Factor @ max. Load.	> 0.95						
Total Harmonic Distortion @ max. Load.	< 20%						
Leakage Current	< 0.75mA @ 277Vac						

1) 100% Load (typical) and tested after 30 minutes warm up.

### Output Ratings / Characteristics

Nominal Output Voltage (per channel)	24Vdc		
Max. No Load Output Voltage (per channel)	25.2Vdc		
Output Current Range (per channel)	0.10A – 4.15A	0.10A – 4.00A	0.10A – 4.00A
Max. Output Power (per channel)	99.6W	96W	96W
Output Channel	1	1	2
Max. Output Power (total output)	99.6W	96W	192W
Output Voltage Tolerance	± 3%		
Line Regulation	± 1%		
Load Regulation	± 3%		
Output Ripple Voltage	< 1000mVp-p		
Rise Time	< 50ms		
Start-up Time	< 1s		

# LED Driver

## USVI S24 Series

Model Number	USVI-100024DG	USVI-100024FG	USVI-100024DE	USVI-100024FE	USVI-100024FH	USVI-200024FA
--------------	---------------	---------------	---------------	---------------	---------------	---------------

### Mechanical

Casing	Metal sheet, Color: White					
Dimensions (L x W x H)	[inch]	9.50 x 1.70 x 1.00		9.50 x 1.70 x 1.18		16.70 x 1.70 x 1.18
	[mm]	241.3 x 43.1 x 25.4		241.3 x 43.1 x 30.0		424.0 x 43.1 x 30.0
Unit Weight	[lbs]	1.08		1.32		2.6
	[kg]	0.49		0.60		1.18
Cooling System	Convection					
Input Wire	Line: Black, Neutral: White, Wire Length 300mm					
Output Wire		Dim+: Violet, Dim-: Gray, Positive: Red, Negative: Blue, Wires Length 300mm	Positive: Red, Negative: Blue, Wires Length 300mm	Dim+: Violet, Dim-: Gray, Positive: Red, Negative: Blue, Wires Length 300mm	Positive: Red, Negative: Blue, Wires Length 300mm	Positive: Red, Negative: Red/White, Wire Length 12.5inch (317mm) Positive: Blue, Negative: Blue/White, Wires Length 18.50inch (470mm)
Noise (30cm distance)	Sound Pressure Level (SPL) < 24dBa					

### Environment

Ambient Temperature	Operating	-40°C to +55°C			
	Storage	-40°C to +85°C			
Case Temperature (for UL)	+90°C				
Case Temperature (for warranty)	+80°C			+80°C	+75°C
Relative Humidity	Operating	10 to 90% RH (Non-Condensing)			
	Storage	5 to 95% RH (Non-Condensing)			
Environmental Locations	UL Dry & Damp				

### Protections

Over Voltage	Auto-Recovery when the fault is removed
Overload / Overcurrent	Auto-Recovery when the fault is removed
Short Circuit	Auto-Recovery when the fault is removed
Over Temperature	Auto-Recovery when the fault is removed
Suitable for Luminaires Class	Class II. Insulation Class according to IEC 60598

### Reliability Data

Lifetime	50,000 hrs. at lifetime case temperature
MTTF	500,000 hrs. @ 40°C ambient temperature (as per Telcordia SR-332, survival rate more than 90%)

# LED Driver

## USVI S24 Series

Model Number	USVI-100024DG	USVI-100024FG	USVI-100024DE	USVI-100024FE	USVI-100024FH	USVI-200024FA
--------------	---------------	---------------	---------------	---------------	---------------	---------------

### Safety Standards / Directives

Electrical Safety	cULus	UL 8750, Class P, type "HL". Class 2 Output			
	CSA	N/A		CAN/CSA C22.2 No.250.13	CAN/CSA C22.2 No.250.13
	CE	IEC 61347-1, IEC 61347-2-13, SELV Output	N/A	IEC 61347-1, IEC 61347-2-13, SELV Output	N/A
Material and Parts		RoHS Directive Compliant			
Isolation		Input	Output	DIM ±	Case
	Input	N/A	3000V	3000V	3000V
	Output	3000V	N/A	N/A	500V
	DIM ±	3000V	N/A	N/A	500V
	Case	3000V	500V	500V	N/A
Isolation for USVI-200024FA	Input	N/A	2500Vac	N/A	2500Vac
	Output	2500Vac	N/A	N/A	500Vac
	Case	2500Vac	500Vac	N/A	N/A

### EMC

#### USVI-100024DE / USVI-100024FE / USVI-100024DG / USVI-100024FG

Emissions	Compliance to 47 CFR FCC Part 15, Subpart B, Class B	
Surge	ANSI C62.41	Category A1 with a 2.5kV/100kA ring wave

#### USVI-100024FH / USVI-200024FA

Emissions	Compliance to 47 CFR FCC Part 15, Subpart B, Class A	
Surge	ANSI C62.41	Category A1 with a 2.5kV/100kA ring wave



# LED Driver

## USVI S24 Series

### EMC (RE & CE)

#### USVI-100024DG / USVI-100024FG / USVI-100024FH

Emissions	Compliance to EN 55015	
Immunity	Compliance to EN 61547	
Electrostatic Discharge	IEC 61000-4-2	Air Discharge: 8kV; Contact Discharge: 4kV Criteria A <sup>1)</sup> or B <sup>2)</sup>
Radiated Disturbance	IEC 61000-4-3	80MHz-1GHz, 3V/m with 1kHz Sine Wave / 80% AM Modulation Criteria A <sup>1)</sup>
Electrical Fast Transient / Burst	IEC 61000-4-4	1kV, Criteria A <sup>1)</sup> or B <sup>2)</sup>
Surge	IEC 61000-4-5	Common Mode <sup>3)</sup> : 4kV; Differential Mode <sup>4)</sup> : 2kV 1.2/50µs, 8/20µs Combination Wave with 2ohms (L-N), 12ohms (L-PE & N-PE) source impedance Criteria A <sup>1)</sup> or B <sup>2)</sup>
Conducted Disturbance	IEC 61000-4-6	150kHz-80MHz, 3Vrms, Criteria A <sup>1)</sup>
Power Frequency Magnetic Fields	IEC 61000-4-8	3A/Meter, Criteria A <sup>1)</sup>
Voltage Dips	IEC 61000-4-11	100% dip; 0.5 cycle; Self Recoverable 30% dip; 10 cycle; Self Recoverable, Criteria A <sup>1)</sup> or B <sup>2)</sup>
Harmonic Current Emission	IEC 61000-3-2	Class C (230Vac @ 100% load)
Voltage Fluctuation and Flicker	IEC 61000-3-3	$P_{st} \leq 1.0$ ; $d_{max} \leq 4\%$ ; $P_{It} \leq 0.65$ ; $d_c \leq 3.3\%$ ; $T_{max} \leq 500ms$

- 1) Criteria A: Normal performance within the specification limits
- 2) Criteria B: Temporary degradation or loss of function, which is self-recoverable
- 3) Asymmetrical: Common mode (Line to earth)
- 4) Symmetrical: Differential mode (Line to line)

### Dimming Curve – dimming voltage vs. output voltage

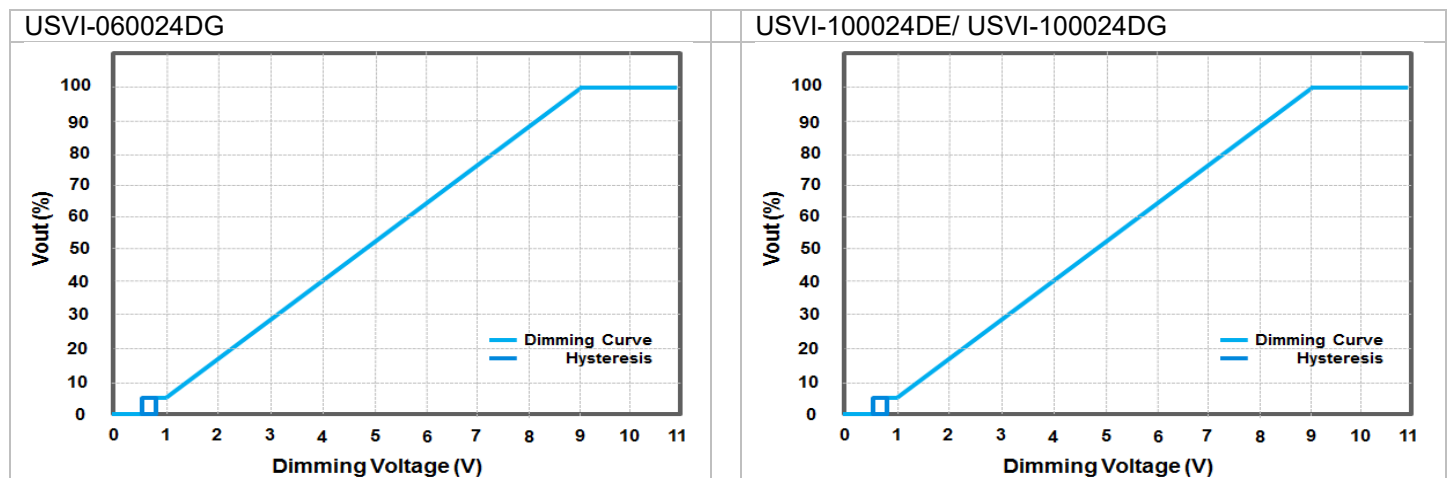

# LED Driver

## USVI S24 Series

### Driver Lifetime vs. Case Temperature

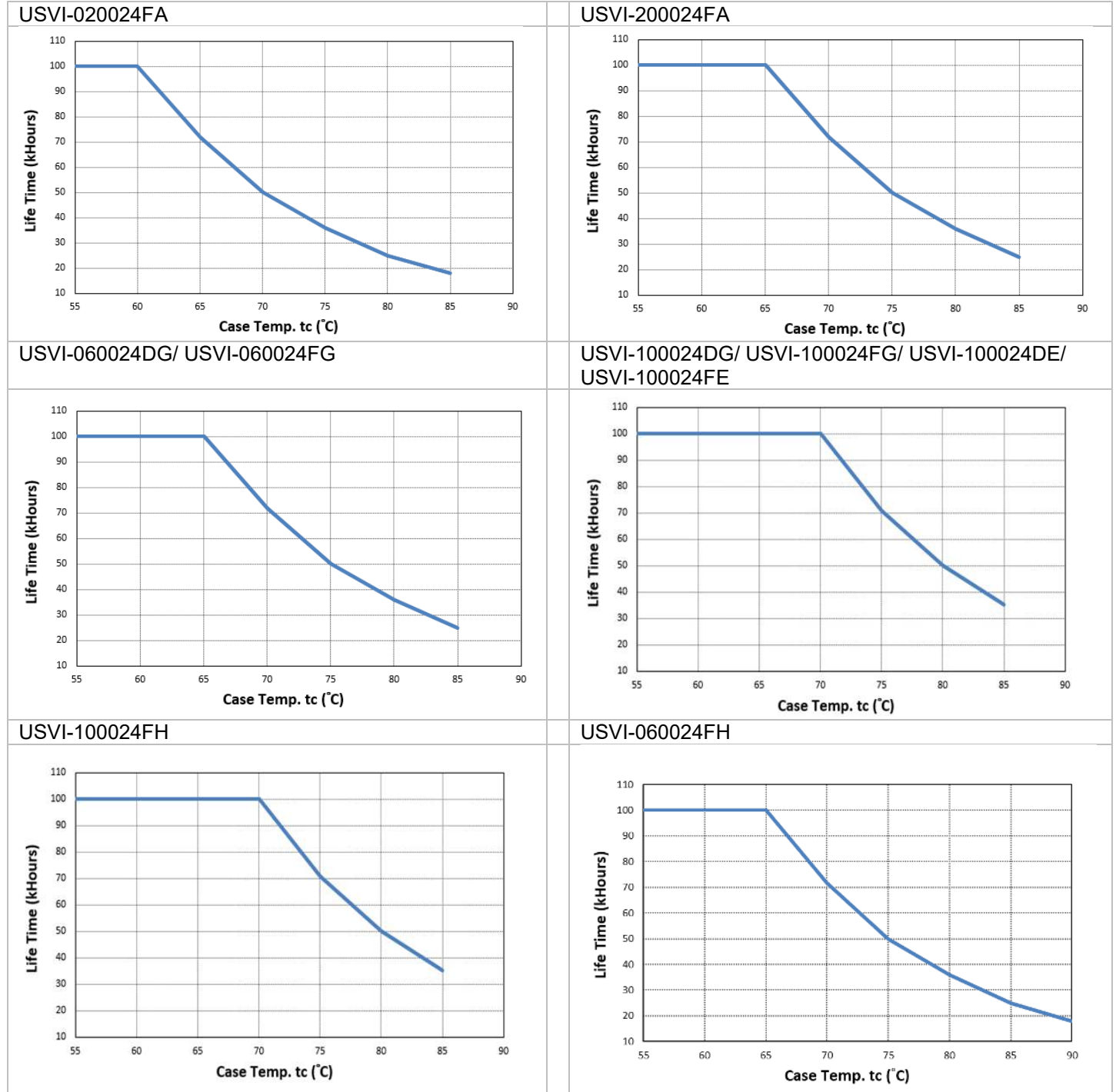

# LED Driver

## USVI S24 Series

### Efficiency vs. Output Power

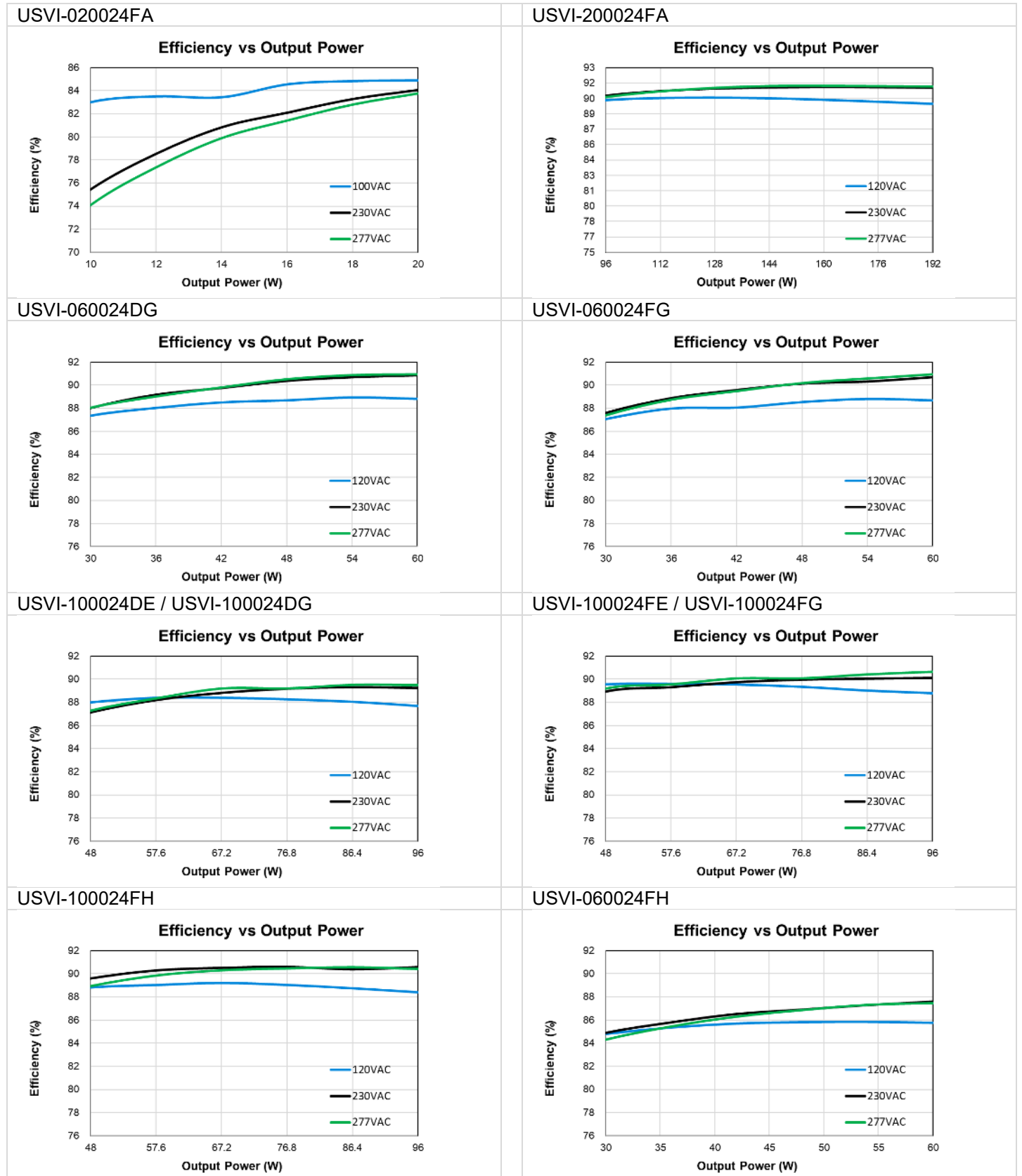

# LED Driver

## USVI S24 Series

### Power Factor vs. Output Power

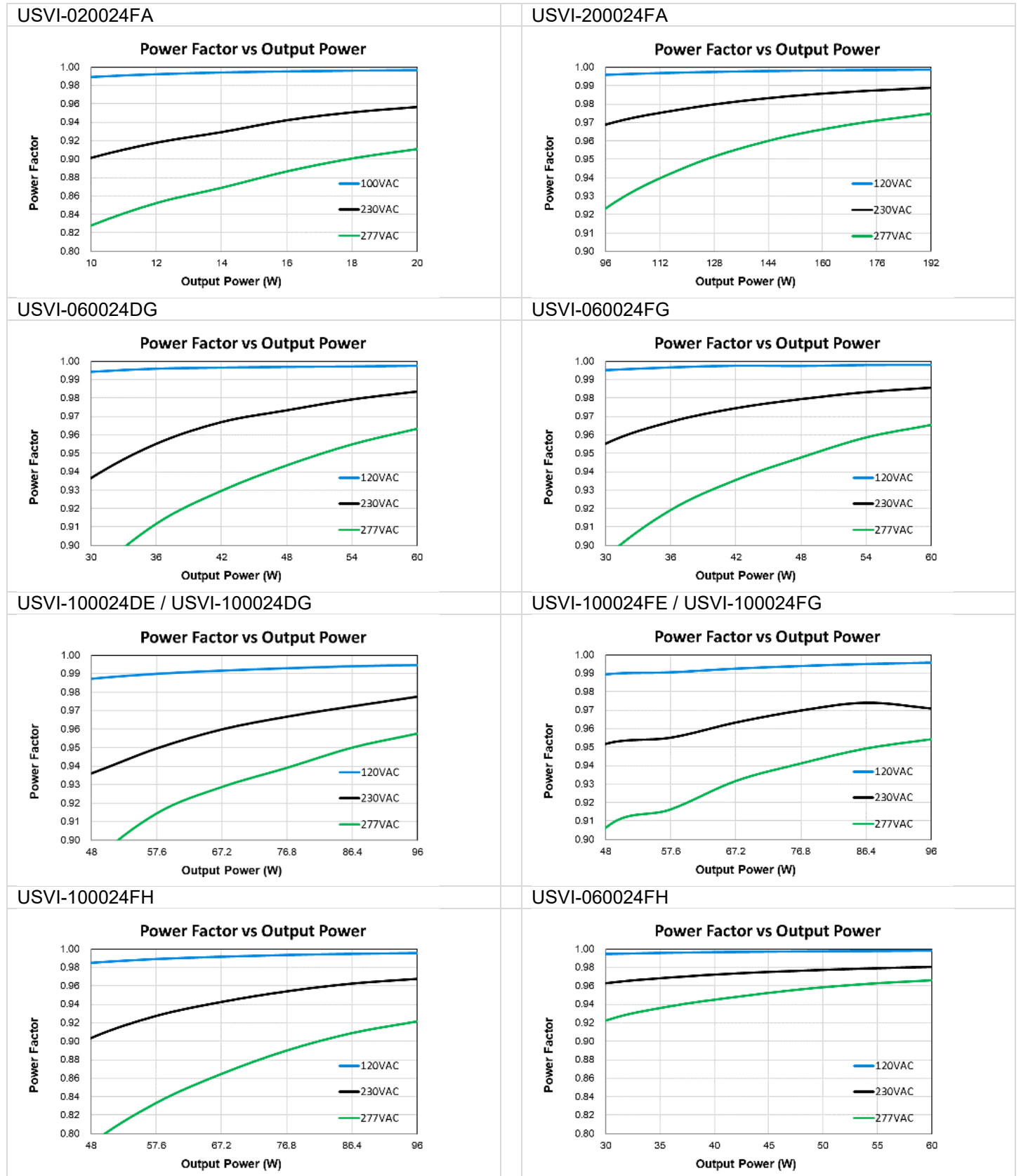

# LED Driver

## USVI S24 Series

### Total Harmonic Distortion vs. Output Power

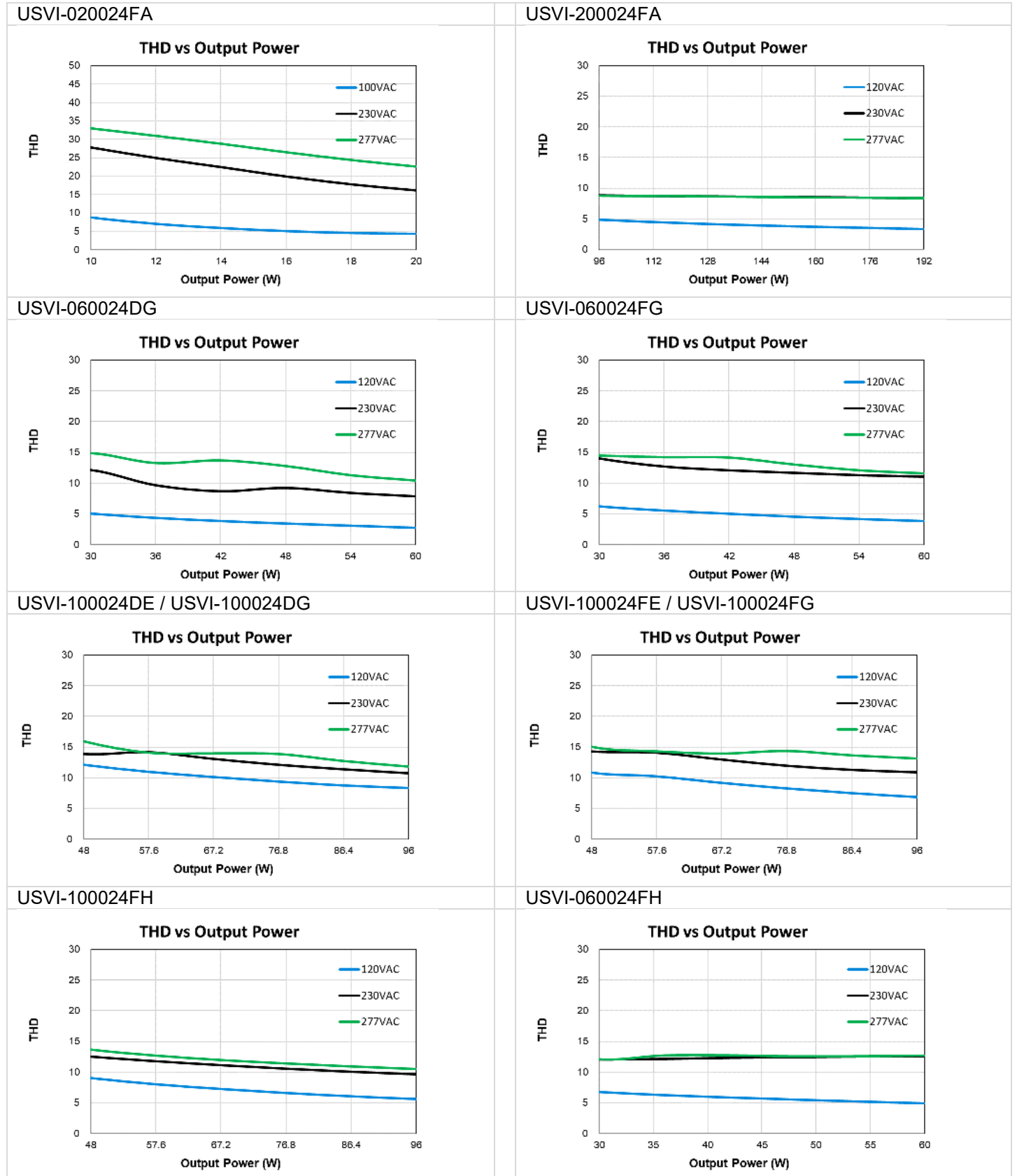

# LED Driver

## USVI S24 Series

### Dimensions

USVI-020024FA

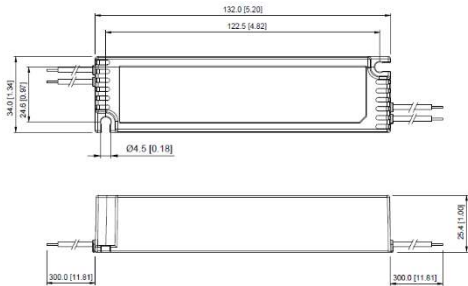

Unit:mm

USVI060024FG

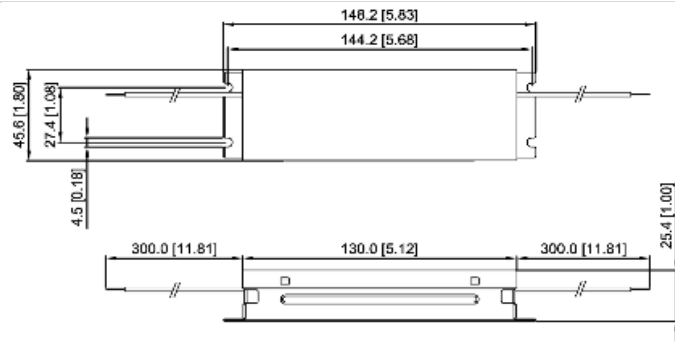

Unit:mm

USVI-100024FE / USVI100024FG

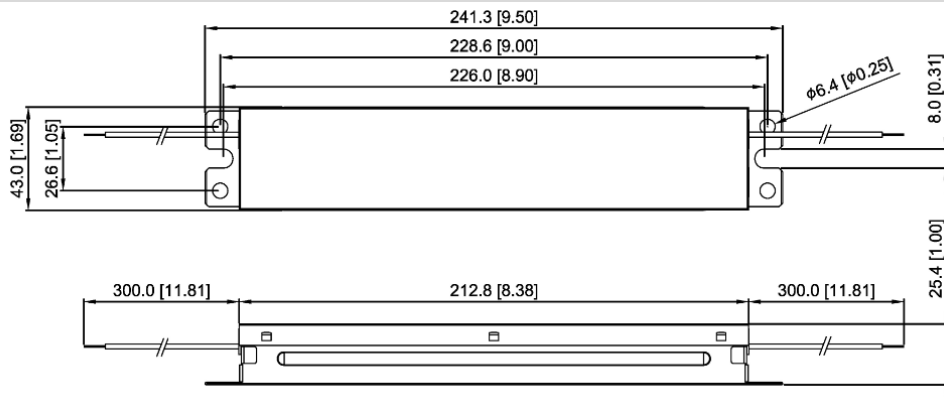

Unit:mm

# LED Driver

## USVI S24 Series

USVI-100024DE / USVI100024DG

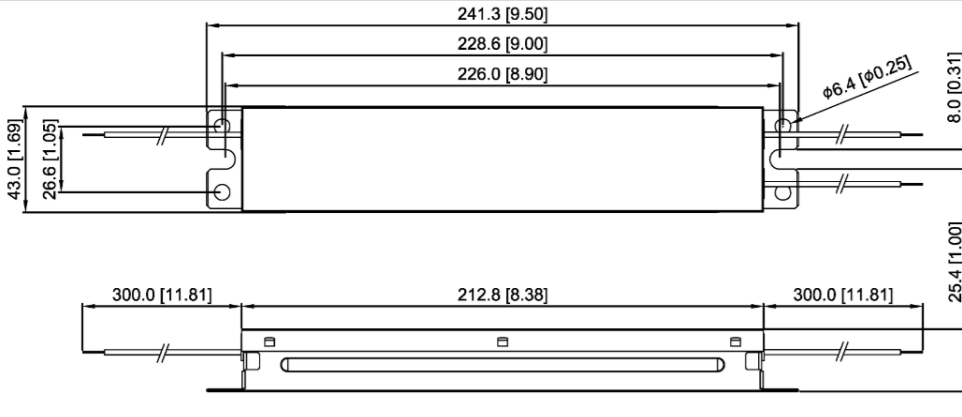

Unit:mm

USVI-060024FH / USVI-100024FH

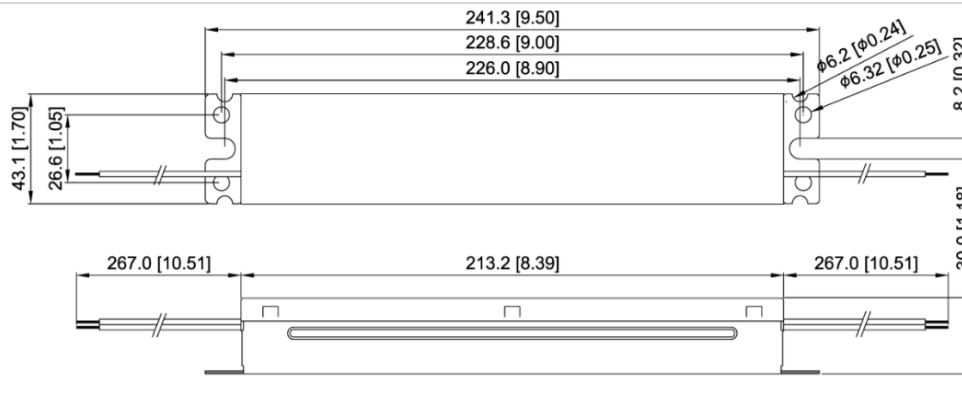

Unit:mm

USVI-200024FA

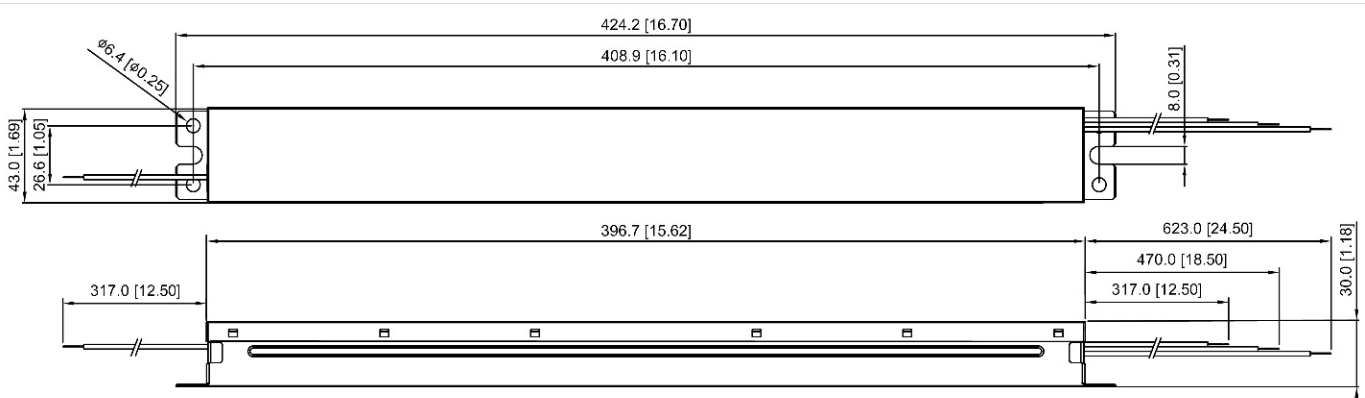

Unit:mm

### Others

#### Warranty Policy

Please reach out our [Warranty Policy](#) should you require any further clarification.