

# MOSFET – Power, N-Channel, SUPERFET® III, Easy Drive

650 V, 24 A, 125 mΩ

## FCPF125N65S3

### Description

SUPERFET III MOSFET is onsemi’s brand-new high voltage super-junction (SJ) MOSFET family that is utilizing charge balance technology for outstanding low on-resistance and lower gate charge performance. This advanced technology is tailored to minimize conduction loss, provides superior switching performance, and withstand extreme dv/dt rate.

Consequently, SUPERFET III MOSFET Easy drive series helps manage EMI issues and allows for easier design implementation.

### Features

- 700 V @  $T_J = 150^\circ\text{C}$
- Typ.  $R_{DS(on)} = 105\text{ m}\Omega$
- Ultra Low Gate Charge (Typ.  $Q_g = 44\text{ nC}$ )
- Low Effective Output Capacitance (Typ.  $C_{oss(eff.)} = 405\text{ pF}$ )
- 100% Avalanche Tested
- These Devices are Pb-Free and are RoHS Compliant

### Applications

- Computing / Display Power Supplies
- Telecom / Server Power Supplies
- Industrial Power Supplies
- Lighting / Charger / Adapter

| $V_{DSS}$ | $R_{DS(on)}\text{ MAX}$ | $I_D\text{ MAX}$ |
|-----------|-------------------------|------------------|
| 650 V     | 125 mΩ @ 10 V           | 24 A             |

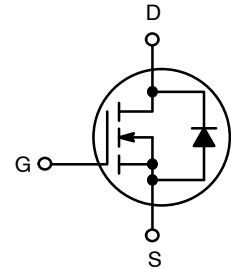

POWER MOSFET

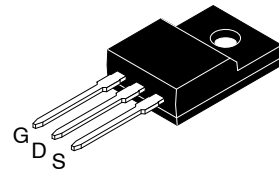

TO-220F  
CASE 221AT

### MARKING DIAGRAM

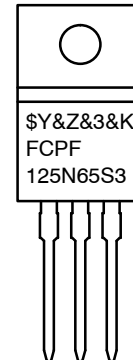

|              |                           |
|--------------|---------------------------|
| \$Y          | = onsemi Logo             |
| &Z           | = Assembly Plant Code     |
| &3           | = Data Code (Year & Week) |
| &K           | = Lot                     |
| FCPF125N65S3 | = Specific Device Code    |

### ORDERING INFORMATION

See detailed ordering and shipping information on page 2 of this data sheet.

# FCPF125N65S3

## ABSOLUTE MAXIMUM RATINGS (T<sub>C</sub> = 25°C, Unless otherwise noted)

| Symbol                            | Parameter  | Value                                 | Unit |
|-----------------------------------|--|---------------------------------------|------|
| V <sub>DSS</sub>                  | Drain to Source Voltage  | 650                                   | V    |
| V <sub>GSS</sub>                  | Gate to Source Voltage   | - DC                                  | ±30  |
|                                   |  | - AC (f > 1 Hz)                       | ±30  |
| I <sub>D</sub>                    | Drain Current  | - Continuous (T <sub>C</sub> = 25°C)  | 24*  |
|                                   |  | - Continuous (T <sub>C</sub> = 100°C) | 15*  |
| I <sub>DM</sub>                   | Drain Current  | - Pulsed (Note 1)                     | 60*  |
| E <sub>AS</sub>                   | Single Pulsed Avalanche Energy (Note 2)                              | 115                                   | mJ   |
| I <sub>AS</sub>                   | Avalanche Current (Note 2)   | 3.7                                   | A    |
| E <sub>AR</sub>                   | Repetitive Avalanche Energy (Note 1)                                 | 0.38                                  | mJ   |
| dv/dt                             | MOSFET dv/dt   | 100                                   | V/ns |
|                                   | Peak Diode Recovery dv/dt (Note 3)                                   | 20                                    |      |
| P <sub>D</sub>                    | Power Dissipation  | (T <sub>C</sub> = 25°C)               | 38   |
|                                   |  | - Derate Above 25°C                   | 0.31 |
| T <sub>J</sub> , T <sub>STG</sub> | Operating and Storage Temperature Range                              | -55 to +150                           | °C   |
| T <sub>L</sub>                    | Maximum Lead Temperature for Soldering, 1/8" from Case for 5 seconds | 300                                   | °C   |

Stresses exceeding those listed in the Maximum Ratings table may damage the device. If any of these limits are exceeded, device functionality should not be assumed, damage may occur and reliability may be affected.

\*Drain current limited by maximum junction temperature.

1. Repetitive rating; pulse-width limited by maximum junction temperature.
2. I<sub>AS</sub> = 3.7 A, R<sub>G</sub> = 25 Ω, starting T<sub>J</sub> = 25°C.
3. I<sub>SD</sub> ≤ 12 A, di/dt ≤ 200 A/μs, V<sub>DD</sub> ≤ 400 V, starting T<sub>J</sub> = 25°C.

## THERMAL CHARACTERISTICS

| Symbol           | Parameter                                     | Value | Unit |
|------------------|---|-------|------|
| R <sub>θJC</sub> | Thermal Resistance, Junction to Case, Max.    | 3.24  | °C/W |
| R <sub>θJA</sub> | Thermal Resistance, Junction to Ambient, Max. | 62.5  |      |

## PACKAGE MARKING AND ORDERING INFORMATION

| Part Number  | Top Marking  | Package | Packing Method | Reel Size | Tape Width | Quantity |
|--------------|--------------|---------|----------------|-----------|------------|----------|
| FCPF125N65S3 | FCPF125N65S3 | TO-220F | Tube           | N/A       | N/A        | 50 Units |

# FCPF125N65S3

## ELECTRICAL CHARACTERISTICS ( $T_C = 25^\circ\text{C}$ unless otherwise noted)

| Symbol | Parameter | Test Conditions | Min. | Typ. | Max. | Unit |
|--------|-----------|-----------------|------|------|------|------|
|--------|-----------|-----------------|------|------|------|------|

### OFF CHARACTERISTICS

|                                      |   |  |     |      |      |      |
|--------------------------------------|---|--|-----|------|------|------|
| BV <sub>DSS</sub>                    | Drain to Source Breakdown Voltage         | V <sub>GS</sub> = 0 V, I <sub>D</sub> = 1 mA, T <sub>J</sub> = 25°C  | 650 |      |      | V    |
|                                      |   | V <sub>GS</sub> = 0 V, I <sub>D</sub> = 1 mA, T <sub>J</sub> = 150°C | 700 |      |      | V    |
| ΔBV <sub>DSS</sub> / ΔT <sub>J</sub> | Breakdown Voltage Temperature Coefficient | I <sub>D</sub> = 1 mA, Referenced to 25°C                            |     | 0.65 |      | V/°C |
| I <sub>DSS</sub>                     | Zero Gate Voltage Drain Current           | V <sub>DS</sub> = 650 V, V <sub>GS</sub> = 0 V                       |     |      | 1    | μA   |
|                                      |   | V <sub>DS</sub> = 520 V, T <sub>C</sub> = 125°C                      |     | 1.35 |      |      |
| I <sub>GSS</sub>                     | Gate to Body Leakage Current              | V <sub>GS</sub> = ±30 V, V <sub>DS</sub> = 0 V                       |     |      | ±100 | nA   |

### ON CHARACTERISTICS

|                     |                                      |  |     |     |     |    |
|---------------------|--------------------------------------|--|-----|-----|-----|----|
| V <sub>GS(th)</sub> | Gate Threshold Voltage               | V <sub>GS</sub> = V <sub>DS</sub> , I <sub>D</sub> = 0.54 mA | 2.5 |     | 4.5 | V  |
| R <sub>DS(on)</sub> | Static Drain to Source On Resistance | V <sub>GS</sub> = 10 V, I <sub>D</sub> = 12 A                |     | 105 | 125 | mΩ |
| g <sub>FS</sub>     | Forward Transconductance             | V <sub>DS</sub> = 20 V, I <sub>D</sub> = 12 A                |     | 16  |     | S  |

### DYNAMIC CHARACTERISTICS

|                        |                                   |  |  |      |  |    |
|------------------------|-----------------------------------|--|--|------|--|----|
| C <sub>iss</sub>       | Input Capacitance                 | V <sub>DS</sub> = 400 V, V <sub>GS</sub> = 0 V, f = 1 MHz                          |  | 1790 |  | pF |
| C <sub>oss</sub>       | Output Capacitance                |  |  | 40   |  | pF |
| C <sub>oss(eff.)</sub> | Effective Output Capacitance      | V <sub>DS</sub> = 0 V to 400 V, V <sub>GS</sub> = 0 V                              |  | 405  |  | pF |
| C <sub>oss(er.)</sub>  | Energy Related Output Capacitance | V <sub>DS</sub> = 0 V to 400 V, V <sub>GS</sub> = 0 V                              |  | 60   |  | pF |
| Q <sub>g(tot)</sub>    | Total Gate Charge at 10 V         | V <sub>DS</sub> = 400 V, I <sub>D</sub> = 12 A, V <sub>GS</sub> = 10 V<br>(Note 4) |  | 44   |  | nC |
| Q <sub>gs</sub>        | Gate to Source Gate Charge        |  |  | 12   |  | nC |
| Q <sub>gd</sub>        | Gate to Drain "Miller" Charge     |  |  | 19   |  | nC |
| ESR                    | Equivalent Series Resistance      | f = 1 MHz  |  | 4    |  | Ω  |

### SWITCHING CHARACTERISTICS

|                     |                     |   |  |    |  |    |
|---------------------|---------------------|---|--|----|--|----|
| t <sub>d(on)</sub>  | Turn-On Delay Time  | V <sub>DD</sub> = 400 V, I <sub>D</sub> = 12 A, V <sub>GS</sub> = 10 V,<br>R <sub>g</sub> = 4.7 Ω<br>(Note 4) |  | 22 |  | ns |
| t <sub>r</sub>      | Turn-On Rise Time   |   |  | 25 |  | ns |
| t <sub>d(off)</sub> | Turn-Off Delay Time |   |  | 60 |  | ns |
| t <sub>f</sub>      | Turn-Off Fall Time  |   |  | 15 |  | ns |

### SOURCE-DRAIN DIODE CHARACTERISTICS

|                 |  |  |  |      |     |    |
|-----------------|--|--|--|------|-----|----|
| I <sub>S</sub>  | Maximum Continuous Source to Drain Diode Forward Current |  |  | 24   |     | A  |
| I <sub>SM</sub> | Maximum Pulsed Source to Drain Diode Forward Current     |  |  | 60   |     | A  |
| V <sub>SD</sub> | Source to Drain Diode Forward Voltage                    | V <sub>GS</sub> = 0 V, I <sub>SD</sub> = 12 A                                      |  |      | 1.2 | V  |
| t <sub>rr</sub> | Reverse Recovery Time                                    | V <sub>DD</sub> = 400 V, I <sub>SD</sub> = 12 A,<br>dI <sub>F</sub> /dt = 100 A/μs |  | 362  |     | ns |
| Q <sub>rr</sub> | Reverse Recovery Charge                                  |  |  | 6.36 |     | μC |

Product parametric performance is indicated in the Electrical Characteristics for the listed test conditions, unless otherwise noted. Product performance may not be indicated by the Electrical Characteristics if operated under different conditions.

4. Essentially independent of operating temperature typical characteristics.

TYPICAL PERFORMANCE CHARACTERISTICS

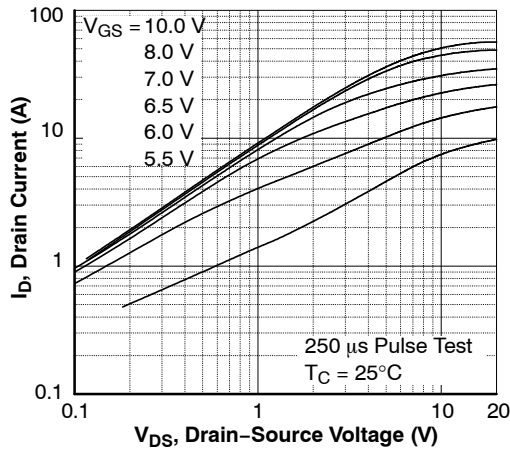

Figure 1. On-Region Characteristics

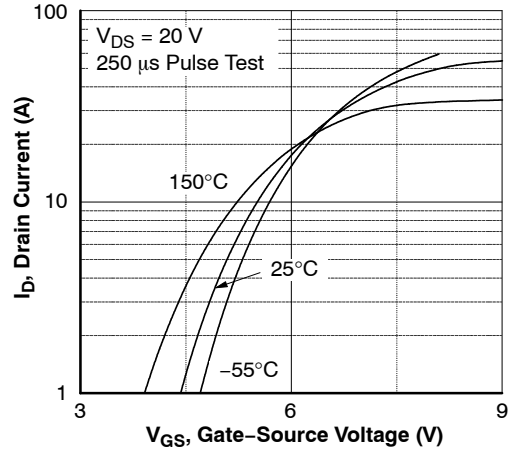

Figure 2. Transfer Characteristics

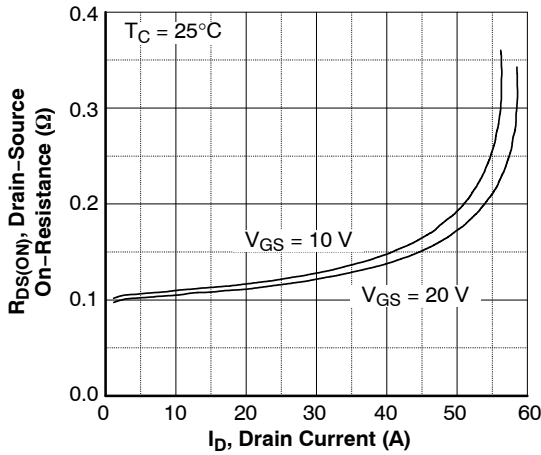

Figure 3. On-Resistance Variation vs. Drain Current and Gate Voltage

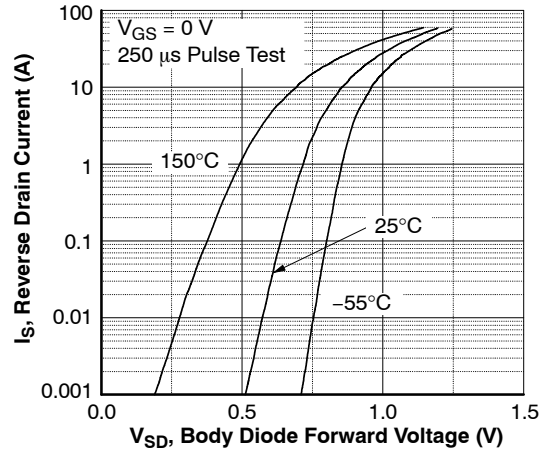

Figure 4. Body Diode Forward Voltage Variation vs. Source Current and Temperature

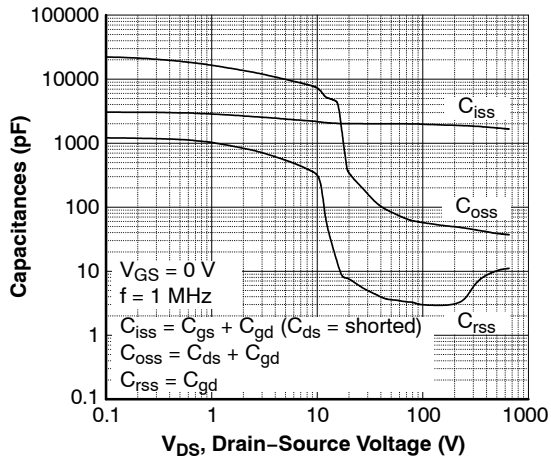

Figure 5. Capacitance Characteristics

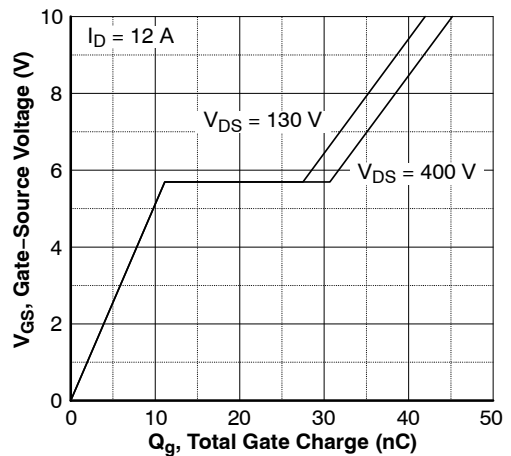

Figure 6. Gate Charge Characteristics

TYPICAL PERFORMANCE CHARACTERISTICS (continued)

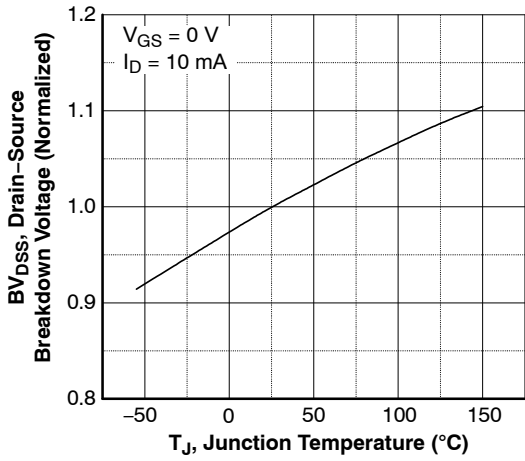

Figure 7. Breakdown Voltage Variation vs. Temperature

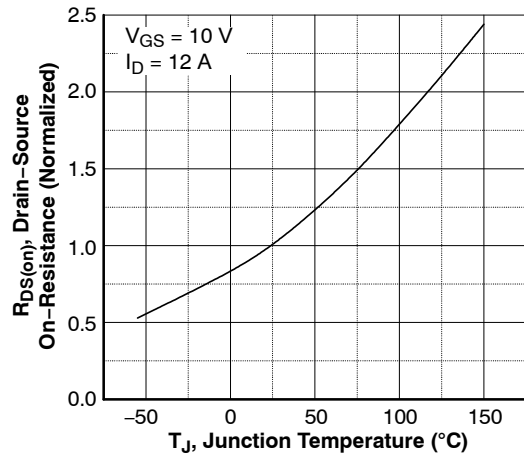

Figure 8. On-Resistance Variation vs. Temperature

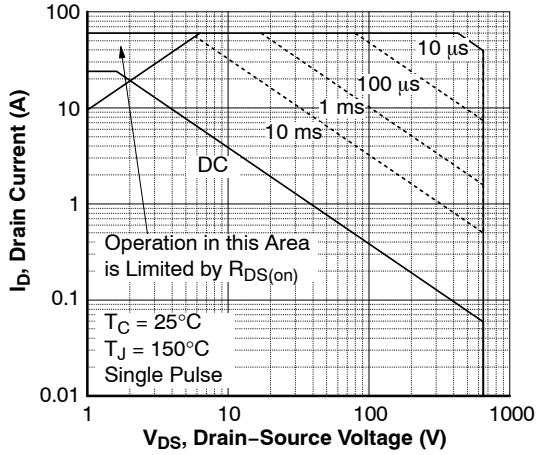

Figure 9. Maximum Safe Operating Area

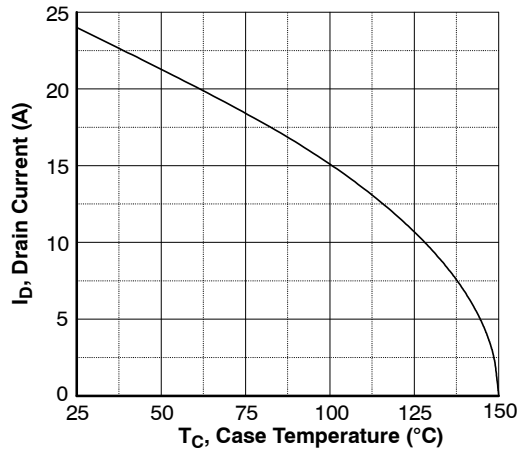

Figure 10. Maximum Drain Current vs. Case Temperature

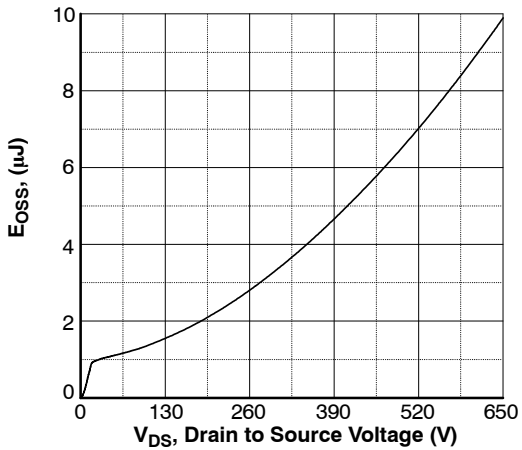

Figure 11. E<sub>OSS</sub> vs. Drain to Source Voltage

# FCPF125N65S3

## TYPICAL PERFORMANCE CHARACTERISTICS (continued)

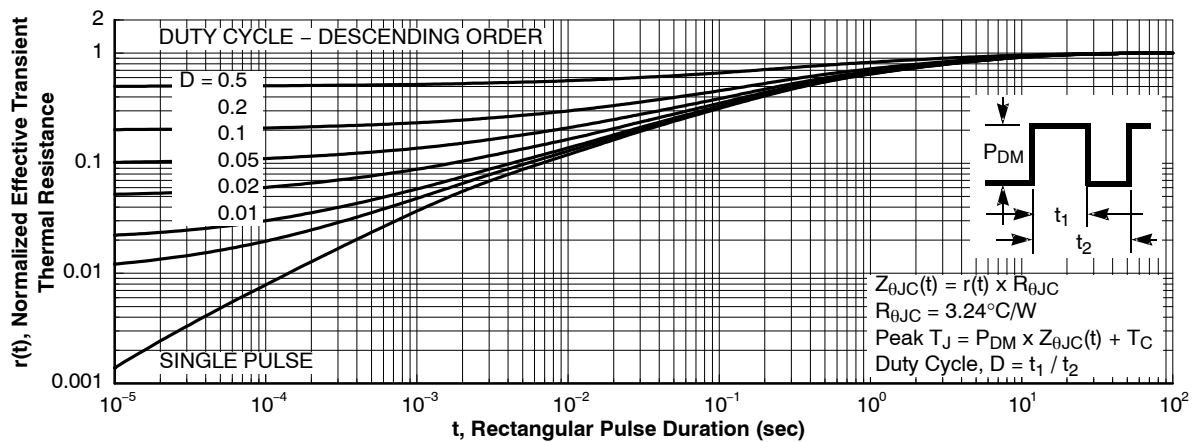

Figure 12. Transient Thermal Response Curve

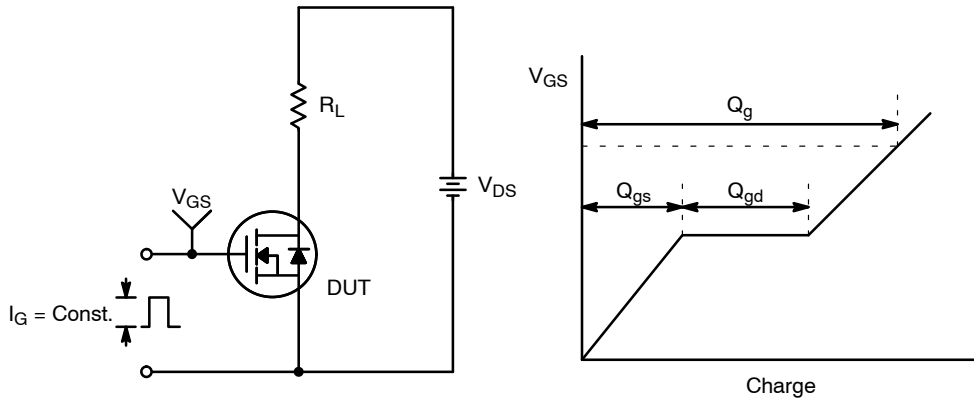

Figure 13. Gate Charge Test Circuit & Waveform

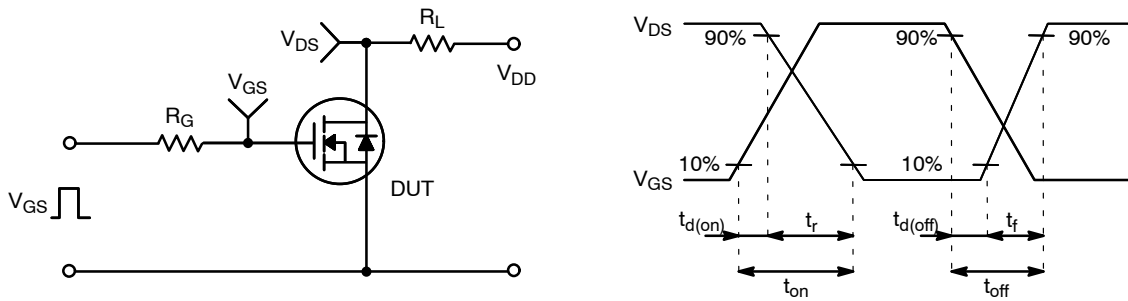

Figure 14. Resistive Switching Test Circuit & Waveforms

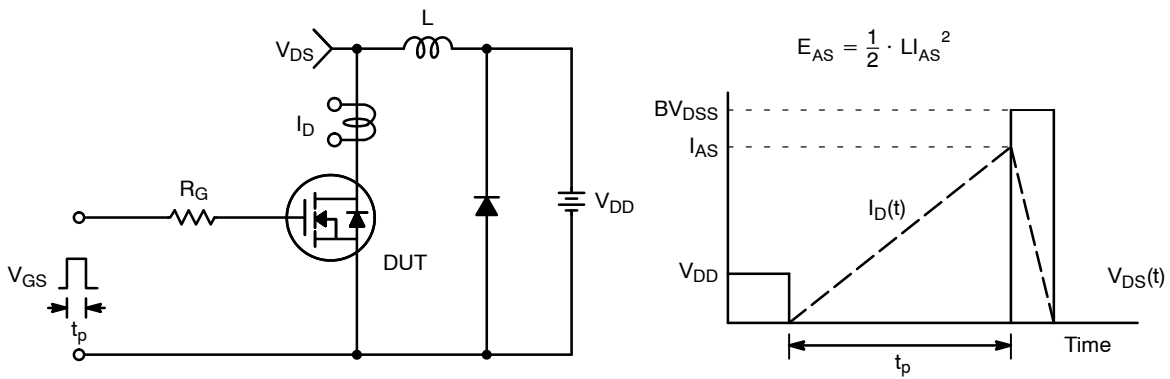
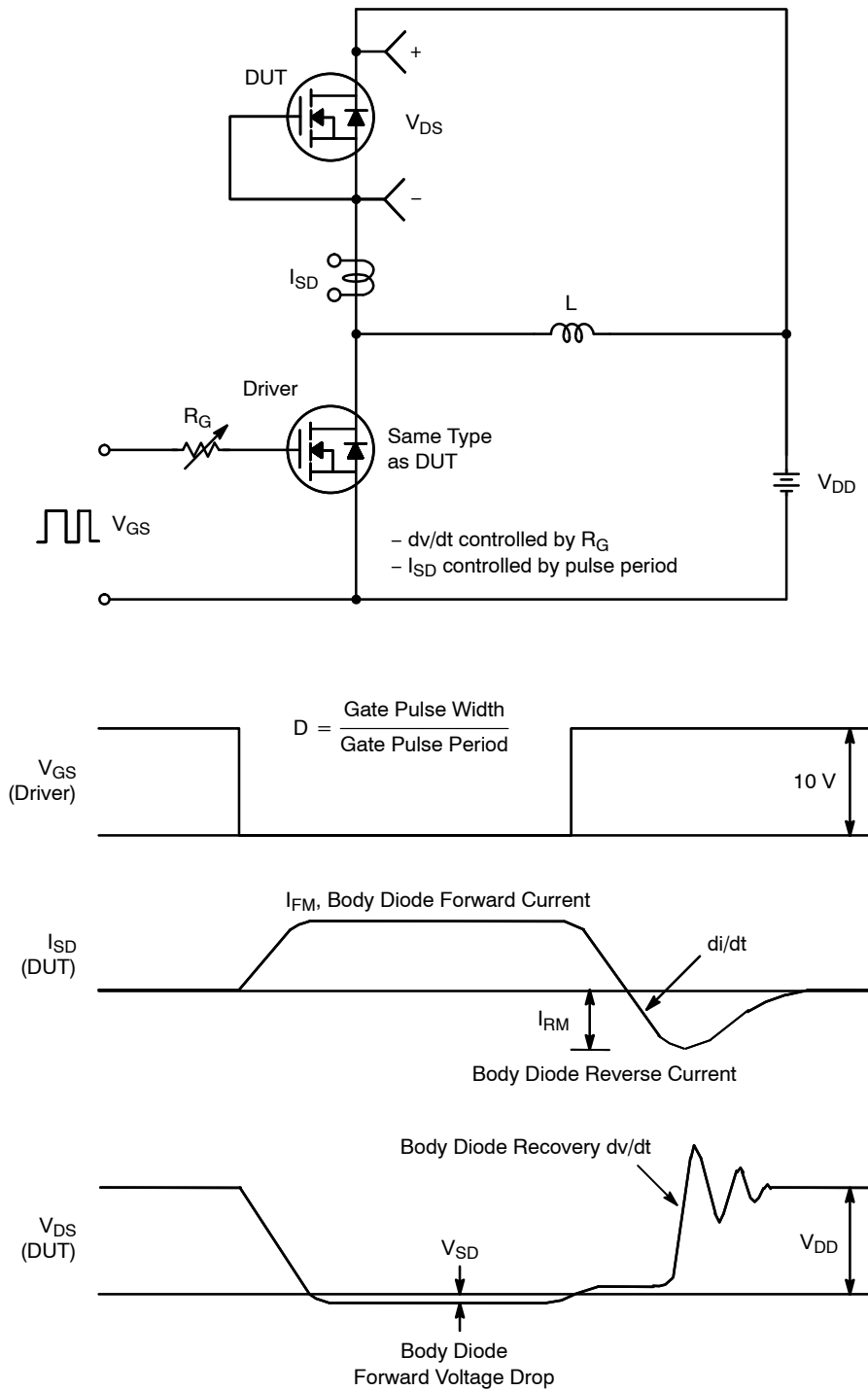

Figure 15. Unclamped Inductive Switching Test Circuit & Waveforms

# FCPF125N65S3



**Figure 16. Peak Diode Recovery  $dv/dt$  Test Circuit & Waveforms**



# MECHANICAL CASE OUTLINE

## PACKAGE DIMENSIONS

ON Semiconductor®



### TO-220 Fullpack, 3-Lead / TO-220F-3SG CASE 221AT ISSUE B

DATE 19 JAN 2021

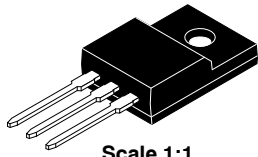

Scale 1:1

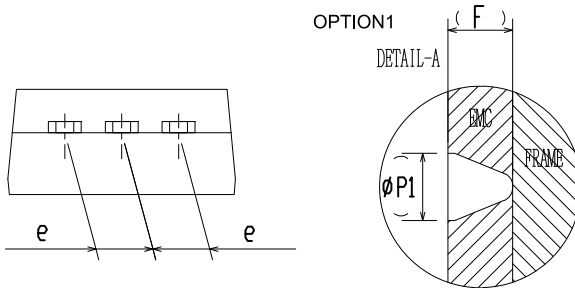
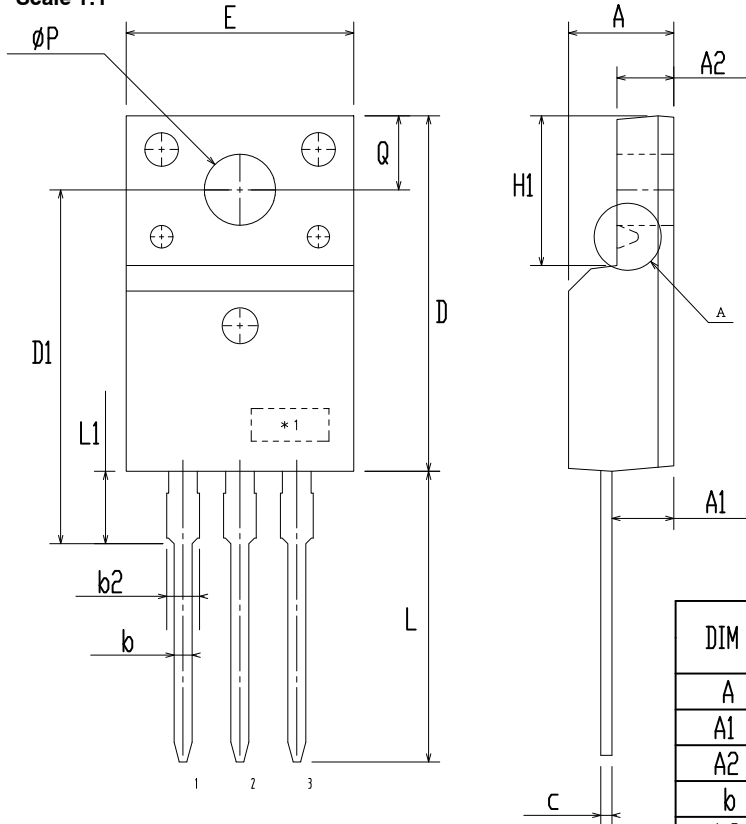

| DIM  | MILLIMETERS |       |       |
|------|-------------|-------|-------|
|      | MIN         | NOM   | MAX   |
| A    | 4.50        | 4.70  | 4.90  |
| A1   | 2.56        | 2.76  | 2.96  |
| A2   | 2.34        | 2.54  | 2.74  |
| b    | 0.70        | 0.80  | 0.90  |
| b2   | ~           | ~     | 1.47  |
| c    | 0.45        | 0.50  | 0.60  |
| D    | 15.67       | 15.87 | 16.07 |
| D1   | 15.60       | 15.80 | 16.00 |
| E    | 9.96        | 10.16 | 10.36 |
| e    | 2.34        | 2.54  | 2.74  |
| F    | ~           | 0.84  | ~     |
| H1   | 6.48        | 6.68  | 6.88  |
| L    | 12.78       | 12.98 | 13.18 |
| L1   | 3.03        | 3.23  | 3.43  |
| ∅ P  | 2.98        | 3.18  | 3.38  |
| ∅ P1 | ~           | 1.00  | ~     |
| Q    | 3.20        | 3.30  | 3.40  |

**NOTES:**

- A. DIMENSION AND TOLERANCE AS ASME Y14.5-2009
- B. DIMENSIONS ARE EXCLUSIVE OF BURRS, MOLD FLASH AND TIE BAR PROTRUCTIONS.
- C. OPTION 1 - WITH SUPPORT PIN HOLE  
OPTION 2 - NO SUPPORT PIN HOLE

|                         |  |   |
|-------------------------|--|---|
| <b>DOCUMENT NUMBER:</b> | <b>98AON67439E</b>                           | Electronic versions are uncontrolled except when accessed directly from the Document Repository.<br>Printed versions are uncontrolled except when stamped "CONTROLLED COPY" in red. |
| <b>DESCRIPTION:</b>     | <b>TO-220 FULLPACK, 3-LEAD / TO-220F-3SG</b> | <b>PAGE 1 OF 1</b>  |

ON Semiconductor and are trademarks of Semiconductor Components Industries, LLC dba ON Semiconductor or its subsidiaries in the United States and/or other countries. ON Semiconductor reserves the right to make changes without further notice to any products herein. ON Semiconductor makes no warranty, representation or guarantee regarding the suitability of its products for any particular purpose, nor does ON Semiconductor assume any liability arising out of the application or use of any product or circuit, and specifically disclaims any and all liability, including without limitation special, consequential or incidental damages. ON Semiconductor does not convey any license under its patent rights nor the rights of others.

**onsemi**, **Onsemi**, and other names, marks, and brands are registered and/or common law trademarks of Semiconductor Components Industries, LLC dba "**onsemi**" or its affiliates and/or subsidiaries in the United States and/or other countries. **onsemi** owns the rights to a number of patents, trademarks, copyrights, trade secrets, and other intellectual property. A listing of **onsemi**'s product/patent coverage may be accessed at [www.onsemi.com/site/pdf/Patent-Marking.pdf](http://www.onsemi.com/site/pdf/Patent-Marking.pdf). **onsemi** reserves the right to make changes at any time to any products or information herein, without notice. The information herein is provided "as-is" and **onsemi** makes no warranty, representation or guarantee regarding the accuracy of the information, product features, availability, functionality, or suitability of its products for any particular purpose, nor does **onsemi** assume any liability arising out of the application or use of any product or circuit, and specifically disclaims any and all liability, including without limitation special, consequential or incidental damages. Buyer is responsible for its products and applications using **onsemi** products, including compliance with all laws, regulations and safety requirements or standards, regardless of any support or applications information provided by **onsemi**. "Typical" parameters which may be provided in **onsemi** data sheets and/or specifications can and do vary in different applications and actual performance may vary over time. All operating parameters, including "Typicals" must be validated for each customer application by customer's technical experts. **onsemi** does not convey any license under any of its intellectual property rights nor the rights of others. **onsemi** products are not designed, intended, or authorized for use as a critical component in life support systems or any FDA Class 3 medical devices or medical devices with a same or similar classification in a foreign jurisdiction or any devices intended for implantation in the human body. Should Buyer purchase or use **onsemi** products for any such unintended or unauthorized application, Buyer shall indemnify and hold **onsemi** and its officers, employees, subsidiaries, affiliates, and distributors harmless against all claims, costs, damages, and expenses, and reasonable attorney fees arising out of, directly or indirectly, any claim of personal injury or death associated with such unintended or unauthorized use, even if such claim alleges that **onsemi** was negligent regarding the design or manufacture of the part. **onsemi** is an Equal Opportunity/Affirmative Action Employer. This literature is subject to all applicable copyright laws and is not for resale in any manner.

## ADDITIONAL INFORMATION

### TECHNICAL PUBLICATIONS:

Technical Library: [www.onsemi.com/design/resources/technical-documentation](http://www.onsemi.com/design/resources/technical-documentation)  
onsemi Website: [www.onsemi.com](http://www.onsemi.com)

### ONLINE SUPPORT: [www.onsemi.com/support](http://www.onsemi.com/support)

For additional information, please contact your local Sales Representative at [www.onsemi.com/support/sales](http://www.onsemi.com/support/sales)