

FEATURES

- Monolithic 10-Bit/60 MSPS Converter
- TTL Outputs
- Bipolar (± 1.75 V) Analog Input
- 56 dB SNR @ 2.3 MHz Input
- Low (45 pF) Input Capacitance
- MIL-STD-883-Compliant Versions Available

APPLICATIONS

- Digital Oscilloscopes
- Medical Imaging
- Professional Video
- Radar Warning/Guidance Systems
- Infrared Systems

GENERAL DESCRIPTION

The AD9020 A/D converter is a 10-bit monolithic converter capable of word rates of 60 MSPS and above. Innovative architecture using 512 input comparators instead of the traditional 1024 required by other flash converters reduces input capacitance and improves linearity.

Encode and outputs are TTL-compatible, making the AD9020 an ideal candidate for use in low power systems. An overflow bit is provided to indicate analog input signals greater than $+V_{SENSE}$.

Voltage sense lines are provided to insure accurate driving of the $\pm V_{REF}$ voltages applied to the units. Quarter-point taps on the resistor ladder help optimize the integral linearity of the unit.

Either 68-pin ceramic leaded (gull wing) packages or ceramic LCCs are available and are specifically designed for low thermal impedances. Two performance grades for temperatures of both 0°C to 70°C and -55°C to $+125^{\circ}\text{C}$ ranges are offered to allow the user to select the linearity best suited for each application. Dynamic performance is fully characterized and production tested at 25°C . MIL-STD-883 units are available.

The AD9020 A/D Converter is available in versions compliant with MIL-STD-883. Refer to the Analog Devices Military Products Databook or current AD9020/883B data sheet for detailed specifications.

FUNCTIONAL BLOCK DIAGRAM

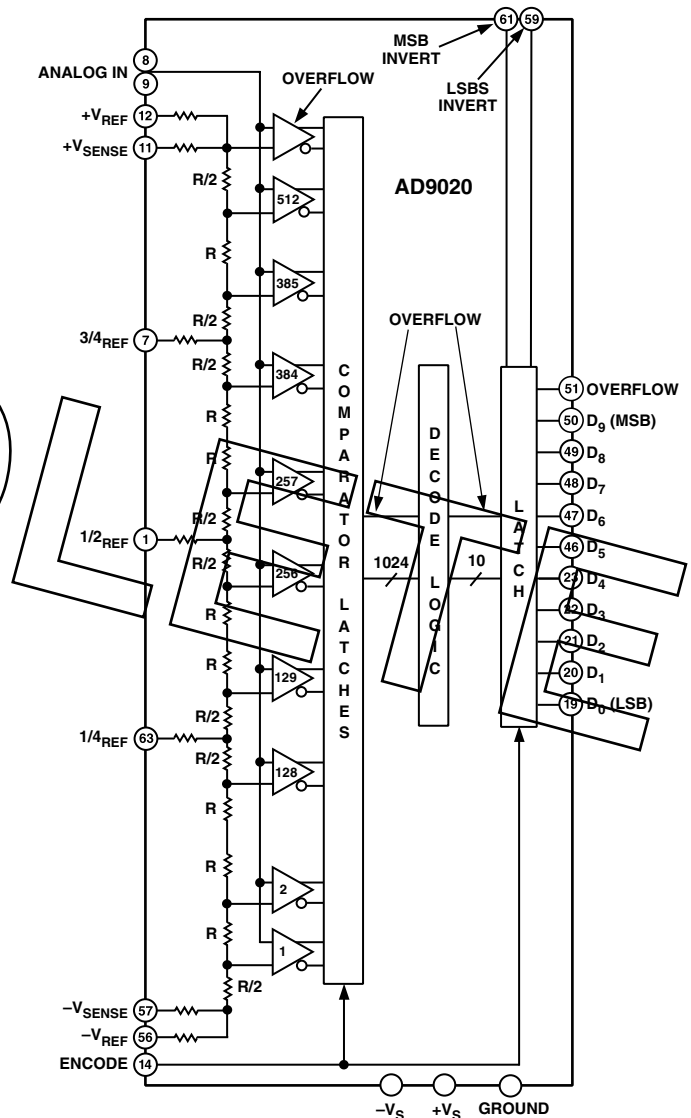

REV. C

Information furnished by Analog Devices is believed to be accurate and reliable. However, no responsibility is assumed by Analog Devices for its use, nor for any infringements of patents or other rights of third parties that may result from its use. No license is granted by implication or otherwise under any patent or patent rights of Analog Devices.

AD9020—SPECIFICATIONS

ABSOLUTE MAXIMUM RATINGS¹

+V _S	+6 V
-V _S	-6 V
ANALOG IN	-2 V to +2 V
+V _{REF} , -V _{REF} , 3/4 _{REF} , 1/2 _{REF} , 1/4 _{REF}	-2 V to +2 V
+V _{REF} to -V _{REF}	4.0 V
DIGITAL INPUTS	-0.5 V to +V _S

3/4 _{REF} , 1/2 _{REF} , 1/4 _{REF} Current	±10 mA
Digital Output Current	20 mA
Operating Temperature	AD9020JE/KE/JZ/KZ 0°C to 70°C
Storage Temperature	-65°C to +150°C
Maximum Junction Temperature ²	150°C
Lead Soldering Temp (10 sec)	300°C

ELECTRICAL CHARACTERISTICS (±V_S = ±5 V; ±V_{SENSE} = ±1.75 V; ENCODE = 40 MSPS unless otherwise noted)

Parameter (Conditions)	Temp	Test Level	AD9020JE/JZ			AD9020KE/KZ			Unit
			Min	Typ	Max	Min	Typ	Max	
RESOLUTION			10			10			Bits
DC ACCURACY ³									
Differential Nonlinearity	25°C	I		1.0	1.25		0.75	1.0	LSB
	Full	VI			1.5			1.25	LSB
Integral Nonlinearity	25°C	I		1.25	2.75		1.0	2.25	LSB
	Full	VI			3.0			2.50	LSB
No Missing Codes	Full	VI					Guaranteed		
ANALOG INPUT									
Input Bias Current ⁴	25°C	I		0.4	1.0		0.4	1.0	mA
	Full	VI			2.0			2.0	mA
Input Resistance	25°C	I	2.0	7.0		2.0	7.0		kΩ
Input Capacitance ⁴	25°C	V		45			45		pF
Analog Bandwidth	25°C	V		175			175		MHz
REFERENCE INPUT									
Reference Ladder Resistance	25°C	I	22	37	56	22	37	56	Ω
	Full	VI	14		66	14		66	Ω
Ladder Tempco	Full	V		0.1			0.1		Ω/°C
Reference Ladder Offset									
Top of Ladder	25°C	I		45	90		45	90	mV
	Full	VI			90			90	mV
Bottom of Ladder	25°C	I		45	90		45	90	mV
	Full	VI			90			90	mV
Offset Drift Coefficient	Full	V		50			50		μV/°C
SWITCHING PERFORMANCE									
Conversion Rate	25°C	I	60			60			MSPS
Aperture Delay (t _A)	25°C	V		1			1		ns
Aperture Uncertainty (Jitter)	25°C	V		5			5		ps, rms
Output Delay (t _{OD}) ⁵	25°C	I	6	10	13	6	10	13	ns
Output Time Skew ⁵	25°C	I		3	5		3	5	ns
DYNAMIC PERFORMANCE									
Transient Response	25°C	V		10			10		ns
Overvoltage Recovery Time	25°C	V		10			10		ns
Effective Number of Bits (ENOB)									
f _{IN} = 2.3 MHz	25°C	I	7.9	9.0		7.9	9.0		Bits
f _{IN} = 10.3 MHz	25°C	IV	7.6	8.4		7.6	8.4		Bits
f _{IN} = 15.3 MHz	25°C	IV	7.2	8.0		7.2	8.0		Bits
Signal-to-Noise Ratio ⁶									
f _{IN} = 2.3 MHz	25°C	I	49.5	56		49.5	56		dB
f _{IN} = 10.3 MHz	25°C	I	47.5	53		47.5	53		dB
f _{IN} = 15.3 MHz	25°C	I	45.5	50		45.5	50		dB
Signal-to-Noise Ratio ⁶ (Without Harmonics)									
f _{IN} = 2.3 MHz	25°C	I	49.5	56		49.5	56		dB
f _{IN} = 10.3 MHz	25°C	I	49.5	54		49.5	54		dB
f _{IN} = 15.3 MHz	25°C	I	48	52		48	52		dB

Parameter (Conditions)	Temp	Test Level	AD9020JE/JZ			AD9020KE/KZ			Unit
			Min	Typ	Max	Min	Typ	Max	
DYNAMIC PERFORMANCE (continued)									
Harmonic Distortion									
$f_{IN} = 2.3$ MHz	25°C	I	54.5	67		54.5	67		dBc
$f_{IN} = 10.3$ MHz	25°C	I	48.5	59		48.5	59		dBc
$f_{IN} = 15.3$ MHz	25°C	I	46.5	53		46.5	53		dBc
Two-Tone Intermodulation Distortion Rejection ⁷	25°C	V		70			70		dBc
Differential Phase	25°C	V		0.5			0.5		Degree
Differential Gain	25°C	V		1			1		%
ENCODE INPUT									
Logic "1" Voltage	Full	VI	2.0			2.0			V
Logic "0" Voltage	Full	VI			0.8			0.8	V
Logic "1" Current	Full	VI			500			500	μA
Logic "0" Current	Full	VI			800			800	μA
Input Capacitance	25°C	V		5			5		pF
Pulsewidth (High)	25°C	I	6			6			ns
Pulsewidth (Low)	25°C	I	6			6			ns
DIGITAL OUTPUTS									
Logic "1" Voltage ($I_{OL} = 2$ mA)	Full	VI	2.4			2.4			V
Logic "0" Voltage ($I_{OL} = 6$ mA)	Full	VI			0.4				V
POWER SUPPLY									
+V _S Supply Current	25°C	I		440	530		440	530	mA
	Full	VI			542			542	mA
-V _S Supply Current	25°C	I		140	170		140	170	mA
	Full	VI			177			177	mA
Power Dissipation	25°C	I		2.8	3.3		2.8	3.3	W
	Full	VI			3.4			3.4	W
Power Supply Rejection Ratio (PSRR) ⁸	Full	VI		6	10		6	10	mV/V

NOTES

¹Absolute maximum ratings are limiting values to be applied individually, and beyond which the service ability of the circuit may be impaired. Functional operability is not necessarily implied. Exposure to absolute maximum rating conditions for an extended period of time may affect device reliability.

²Typical thermal impedances (part soldered onto board): 68-pin leaded ceramic chip carrier: $\theta_{JC} = 1^\circ\text{C}/\text{W}$; $\theta_{JA} = 17^\circ\text{C}/\text{W}$ (no air flow); $\theta_{JA} = 15^\circ\text{C}/\text{W}$ (air flow = 500 LFM). 68-pin ceramic LCC: $\theta_{JC} = 2.6^\circ\text{C}/\text{W}$; $\theta_{JA} = 15^\circ\text{C}/\text{W}$ (no air flow); $\theta_{JA} = 13^\circ\text{C}/\text{W}$ (air flow = 500 LFM).

³ $3/4_{REF}$, $1/2_{REF}$, and $1/4_{REF}$ reference ladder taps are driven from dc sources at +0.875 V, 0 V, and -0.875 V, respectively. Accuracy of the overflow comparator is not tested and not included in linearity specifications.

⁴Measured with ANALOG IN = +V_{SENSE}.

⁵Output delay measured as worst-case time from 50% point of the rising edge of ENCODE to 50% point of the slowest rising or falling edge of D₀-D₉. Output skew measured as worst-case difference in output delay among D₀-D₉.

⁶RMS signal to rms noise with analog input signal 1 dB below full scale at specified frequency.

⁷Intermodulation measured with analog input frequencies of 2.3 MHz and 3.0 MHz at 7 dB below full scale.

⁸Measured as the ratio of the worst-case change in transition voltage of a single comparator for a 5% change in +V_S or -V_S.

Specifications subject to change without notice.

AD9020

EXPLANATION OF TEST LEVELS

Test Level

- I – 100% production tested.
- II – 100% production tested at 25°C, and sample tested at specified temperatures.
- III – Sample tested only.
- IV – Parameter is guaranteed by design and characterization testing.
- V – Parameter is a typical value only.
- VI – All devices are 100% production tested at 25°C. 100% production tested at temperature extremes for extended temperature devices; sample tested at temperature extremes for commercial/industrial devices.

DIE LAYOUT AND MECHANICAL INFORMATION

Die Dimensions	206 × 140 × 15 (±2) mils
Pad Dimensions	4 × 4 mils
Metalization	Gold
Backing	None
Substrate Potential	-V _S
Passivation	Nitride

ORDERING GUIDE

Device	Temperature Range	Description	Package Option*
AD9020JZ	0°C to 70°C	68-Lead Leaded Ceramic	Z-68
AD9020JE	0°C to 70°C	68-Terminal Ceramic LCC	E-68A
AD9020KZ	0°C to 70°C	68-Lead Leaded Ceramic	Z-68
AD9020KE	0°C to 70°C	68-Terminal Ceramic LCC	E-68A
AD9020SZ/883	-55°C to +125°C	68-Lead Leaded Ceramic	Z-68
AD9020SE/883	-55°C to +125°C	68-Terminal Ceramic LCC	E-68A
AD9020TZ/883	-55°C to +125°C	68-Lead Leaded Ceramic	Z-68
AD9020TE/883	-55°C to +125°C	68-Terminal Ceramic LCC	E-68A
AD9020/PCB	0°C to 70°C	Evaluation Board	

*E = Ceramic Leadless Chip Carrier; Z = Ceramic Leaded Chip Carrier.

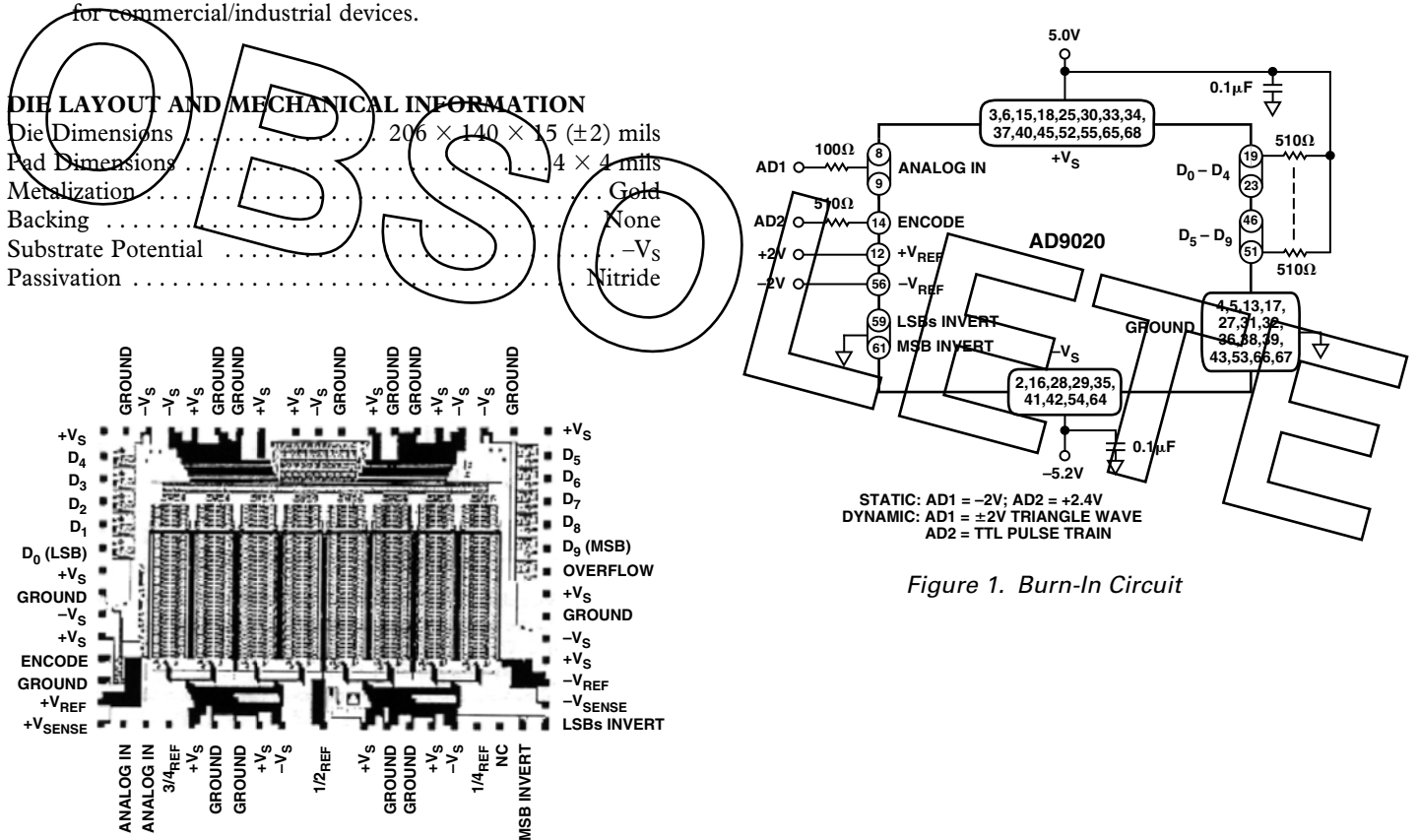

PIN CONFIGURATION

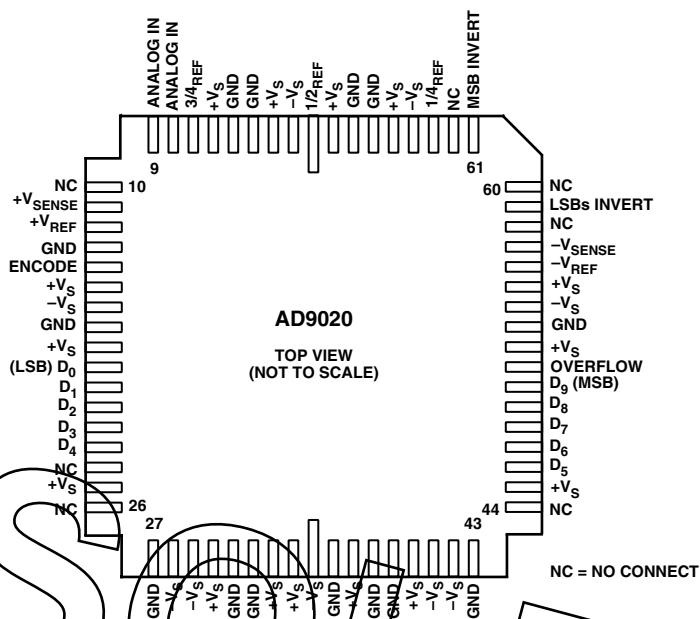

PIN FUNCTION DESCRIPTIONS

Pin No.	Name	Function
1	1/2 _{REF}	Midpoint of internal reference ladder.
2, 16, 28, 29, 35, 41, 42, 54, 64	-V _S	Negative supply voltage; nominally -5.0 V ± 5%.
3, 6, 15, 18, 25, 30, 33, 34, 37, 40, 45, 52, 55, 65, 68	+V _S	Positive supply voltage; nominally 5 V ± 5%.
4, 5, 13, 17, 27, 31, 32, 36, 38, 39, 43, 53, 66, 67	GROUND	All ground pins should be connected together and to low impedance ground plane.
7	3/4 _{REF}	Three-quarter point of internal reference ladder.
8, 9	ANALOG IN	Analog input; nominally between ±1.75 V.
11	+V _{SENSE}	Voltage sense line to most positive point on internal resistor ladder. Normally 1.75 V.
12	+V _{REF}	Voltage force connection for top of internal reference ladder. Normally driven to provide 1.75 V at +V _{SENSE} .
14	ENCODE	TTL-compatible convert command used to begin digitizing process.
19–23, 46–50	D ₀ –D ₄ , D ₅ –D ₉	TTL-compatible digital output data.
51	OVERFLOW	TTL-compatible output indicating ANALOG IN > +V _{SENSE} .
56	-V _{REF}	Voltage force connection for bottom of internal reference ladder. Normally driven to provide -1.75 V at -V _{SENSE} .
57	-V _{SENSE}	Voltage sense line to most negative point on internal resistor ladder. Normally -1.75 V.
59	LSBs INVERT	Normally grounded. When connected to +V _S , lower order bits (D ₀ –D ₈) are inverted.
61	MSB INVERT	Normally grounded. When connected to +V _S , most significant bit (MSB; D ₉) is inverted.
63	1/4 _{REF}	One-quarter point of internal reference ladder.

AD9020

THEORY OF OPERATION

Refer to the AD9020 block diagram. As shown, the AD9020 uses a modified “flash,” or parallel, A/D architecture. The analog input range is determined by an external voltage reference ($+V_{REF}$ and $-V_{REF}$), nominally ± 1.75 V. An internal resistor ladder divides this reference into 512 steps, each representing two quantization levels. Taps along the resistor ladder ($1/4_{REF}$, $1/2_{REF}$ and $3/4_{REF}$) are provided to optimize linearity. Rated performance is achieved by driving these points at $1/4$, $1/2$, and $3/4$, respectively, of the voltage reference range.

The A/D conversion for the nine most significant bits (MSBs) is performed by 512 comparators. The value of the least significant bit (LSB) is determined by a unique interpolation scheme between adjacent comparators. The decoding logic processes the comparator outputs and provides a 10-bit code to the output stage of the converter.

Flash architecture has an advantage over other A/D architectures because conversion occurs in one step. This means the performance of the converter is primarily limited by the speed and matching of the individual comparators. In the AD9020, an innovative interpolation scheme takes advantage of flash architecture but minimizes the input capacitance, power and device count usually associated with that method of conversion.

These advantages occur by using only half the normal number of input comparator cells to accomplish the conversion. In addition, a proprietary decoding scheme minimizes error codes. Input control pins allow the user to select from among Binary, Inverted Binary, Two's Complement and Inverted Two's Complement coding (see Table I).

APPLICATIONS

Many of the specifications used to describe analog/digital converters have evolved from system performance requirements in these applications. Different systems emphasize particular specifications, depending on how the part is used. The following applications highlight some of the specifications and features that make the AD9020 attractive in these systems.

Wideband Receivers

Radar and communication receivers (baseband and direct IF digitization), ultrasound medical imaging, signal intelligence and spectral analysis all place stringent ac performance requirements on analog-to-digital converters (ADCs).

Frequency domain characterization of the AD9020 provides signal-to-noise ratio (SNR) and harmonic distortion data to simplify selection of the ADC.

Receiver sensitivity is limited by the Signal-to-Noise Ratio of the system. The SNR for an ADC is measured in the frequency domain and calculated with a Fast Fourier Transform (FFT). The SNR equals the ratio of the fundamental component of the signal (rms amplitude) to the rms value of the

noise. The noise is the sum of all other spectral components, including harmonic distortion, but excluding dc.

Good receiver design minimizes the level of spurious signals in the system. Spurious signals developed in the ADC are the result of imperfections (nonlinearities, delay mismatch, varying input impedance, etc.) in the device transfer function. In the ADC, these spurious signals appear as Harmonic Distortion. Harmonic Distortion is also measured with an FFT and is specified as the ratio of the fundamental component of the signal (rms amplitude) to the rms value of the worst-case harmonic (usually the 2nd or 3rd).

Two-Tone Intermodulation Distortion (IMD) is a frequently cited specification in receiver design. In narrow-band receivers, third-order IMD products result in spurious signals in the passband of the receiver. Like mixers and amplifiers, the ADC is characterized with two, equal-amplitude, pure input frequencies. The IMD equals the ratio of the power of either of the two input signals to the power of the strongest third-order IMD signal. Unlike mixers and amplifiers, the IMD does not always behave as it does in linear devices (reduced input levels do not result in predictable reductions in IMD).

Performance graphs provide typical harmonic and SNR data for the AD9020 for increasing analog input frequencies. In choosing an A/D converter, always look at the dynamic range for the analog input frequency of interest. The AD9020 specifications provide guaranteed minimum limits at three analog test frequencies.

Aperture Delay is the delay between the rising edge of the ENCODE command and the instant at which the analog input is sampled. Many systems require simultaneous sampling of more than one analog input signal with multiple ADCs. In these situations, timing is critical and the absolute value of the aperture delay is not as critical as the matching between devices.

Aperture Uncertainty, or jitter, is the sample-to-sample variation in aperture delay. This is especially important when sampling high slew rate signals in wide bandwidth systems. Aperture uncertainty is one of the factors that degrade dynamic performance as the analog input frequency is increased.

Digitizing Oscilloscopes

Oscilloscopes provide amplitude information about an observed waveform with respect to time. Digitizing oscilloscopes must accurately sample this signal, without distorting the information to be displayed.

One figure of merit for the ADC in these applications is *Effective Number of Bits (ENOBs)*. ENOB is calculated with a sine wave curve fit and equals:

$$ENOB = N - \text{LOG}_2 [\text{Error (measured)} / \text{Error (ideal)}]$$

N is the resolution (number of bits) of the ADC. The measured error is the actual rms error calculated from the converter outputs with a pure sine wave input.

The *Analog Bandwidth* of the converter is the analog input frequency at which the spectral power of the fundamental signal is reduced 3 dB from its low frequency value. The analog bandwidth is a good indicator of a converter's stewing capabilities.

The *Maximum Conversion Rate* is defined as the encode rate at which the SNR for the lowest analog signal test frequency tested drops by no more than 3 dB below the guaranteed limit.

Imaging

Both visible and infrared imaging systems require similar characteristics from ADCs. The signal input (from a CCD camera, or multiplexer) is a time division multiplexed signal consisting of a series of pulses whose amplitude varies in direct proportion to the intensity of the radiation detected at the sensor. These varying levels are then digitized by applying encode commands at the correct times, as shown in Figure 2.



Figure 2. Imaging Application Using AD9020

The actual resolution of the converter is limited by the thermal and quantization noise of the ADC. The low frequency test for SNR or ENOB is a good measure of the noise of the AD9020. At this frequency, the static errors in the ADC determine the useful dynamic range of the ADC.

Although the signal being sampled does not have a significant slew rate, this does not imply dynamic performance is not important. The *Transient Response and Overvoltage Recovery Time* specifications ensure that the ADC can track full-scale changes in the analog input sufficiently fast to capture a valid sample.

Transient Response is the time required for the AD9020 to achieve full accuracy when a step function is applied. *Overvoltage Recovery Time* is the time required for the AD9020 to recover to full accuracy after an analog input signal 150% of full scale is reduced to the full-scale range of the converter.

Professional Video

Digital Signal Processing (DSP) is now common in television production. Modern studios rely on digitized video to create state-of-the-art special effects. Video instrumentation also requires high resolution ADCs for studio quality measurement and frame storage.

The AD9020 provides sufficient resolution for these demanding applications. Conversion speed, dynamic performance and analog bandwidth are suitable for digitizing both composite and RGB video sources.

USING THE AD9020

Voltage References

The AD9020 requires that the user provide two voltage references: $+V_{REF}$ and $-V_{REF}$. These two voltages are applied across an internal resistor ladder (nominally $37\ \Omega$) and set the analog input voltage range of the converter. The voltage references should be driven from a stable, low impedance source. In addition to these two references, three evenly spaced taps on the resistor ladder ($1/4_{REF}$, $1/2_{REF}$, $3/4_{REF}$) are available. Providing a reference to these quarter points on the resistor ladder will improve the integral linearity of the converter and improve ac performance. (ac and dc specifications are tested while driving the quarter points at the indicated levels.) Figure 3 is not intended to show the transfer function of the ADC, but illustrates how the linearity of the device is affected by reference voltages applied to the ladder.

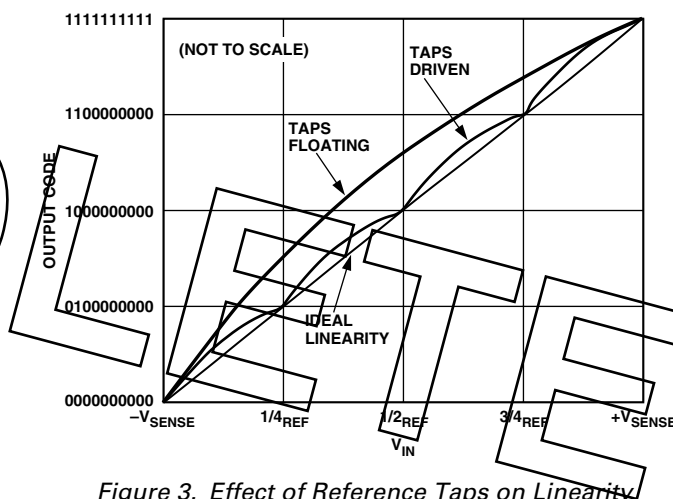

Figure 3. Effect of Reference Taps on Linearity

Resistance between the reference connections and the taps of the first and last comparators causes offset errors. These errors, called “top and bottom of the ladder offsets,” can be nulled by using the voltage sense lines, $+V_{SENSE}$ and $-V_{SENSE}$, to adjust the reference voltages. Current through the sense lines should be limited to less than $100\ \mu\text{A}$. Excessive current drawn through the voltage sense lines will affect the accuracy of the sense line voltage.

AD9020

Figure 5 shows a reference circuit that nulls out the offset errors using two op amps, and provides appropriate voltage references to the quarter-point taps. Feedback from the sense lines causes the op amps to compensate for the offset errors. The two transistors limit the amount of current drawn directly from the op amps; resistors at the base connections stabilize their operation. The 10 k Ω resistors (R1–R4) between the voltage sense lines form an external resistor ladder; the quarter point voltages are taken off this external ladder and buffered by an op amp. The actual values of resistors R1–R4 are not critical, but they should match well and be large enough (≥ 10 k Ω) to limit the amount of current drawn from the voltage sense lines.

The select resistors (R_S) shown in the schematic (each pair can be a potentiometer) are chosen to adjust the quarter-point voltage references, but are not necessary if R1–R4 match within 0.05%.

An alternative approach for defining the quarter-point references of the resistor ladder is to evaluate the integral linearity error of an individual device, and adjust the voltage at the quarter-points to minimize this error. This may improve the low frequency ac performance of the converter.

Performance of the AD9020 has been optimized with an analog input voltage of ± 1.75 V (as measured at $\pm V_{\text{SENSE}}$). If the analog input range is reduced below these values, relatively larger differential nonlinearity errors may result because of comparator mismatches. As shown in Figure 4, performance of the converter is a function of $\pm V_{\text{SENSE}}$.

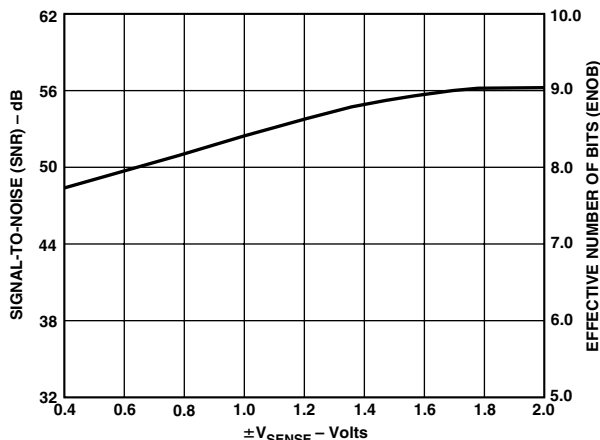

Figure 4. SNR and ENOB vs. Reference Voltage

Applying a voltage greater than 4 V across the internal resistor ladder will cause current densities to exceed rated values, and may cause permanent damage to the AD9020. The design of the reference circuit should limit the voltage available to the references.

Analog Input Signal

The signal applied to ANALOG IN drives the inputs of 512 parallel comparator cells (see Figure 6). This connection typically has an input resistance of 7 k Ω , and input capacitance of 45 pF. The input capacitance is nearly constant over the analog input voltage range, as shown in the graph that illustrates that characteristic.

The analog input signal should be driven from a low-distortion, low-noise amplifier. A good choice is the AD9617, a wide bandwidth, monolithic operational amplifier with excellent ac and dc performance. The input capacitance should be isolated by a small series resistor (24 Ω for the AD9617) to improve the ac performance of the amplifier (see Figure 14).

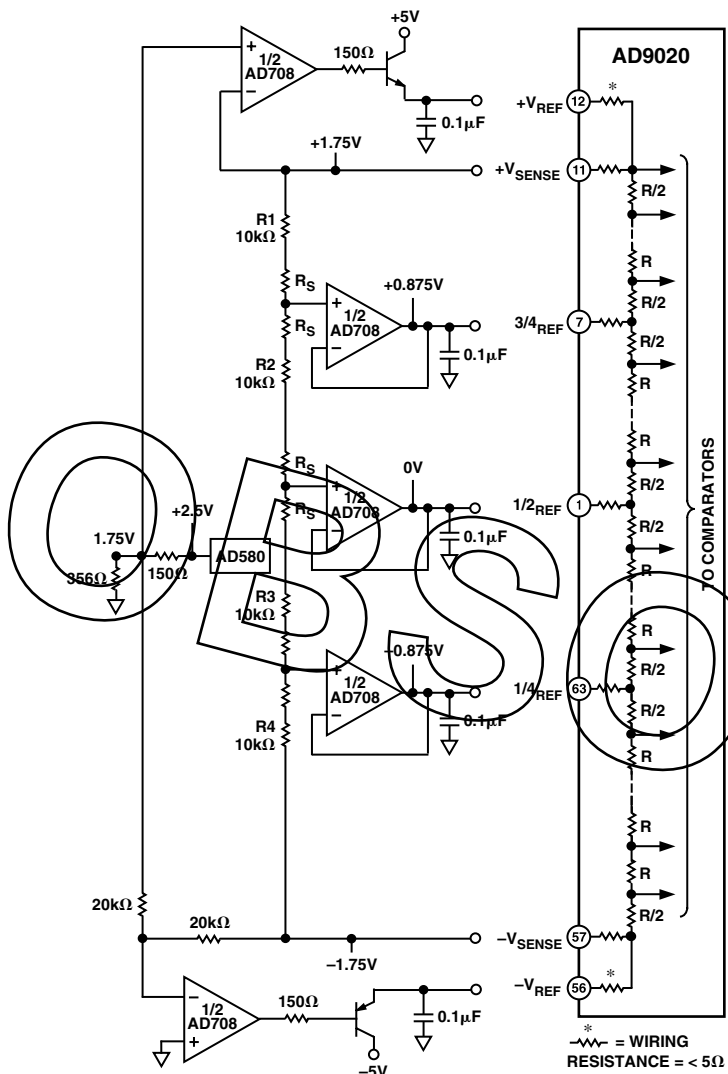

Figure 5. Reference Circuit

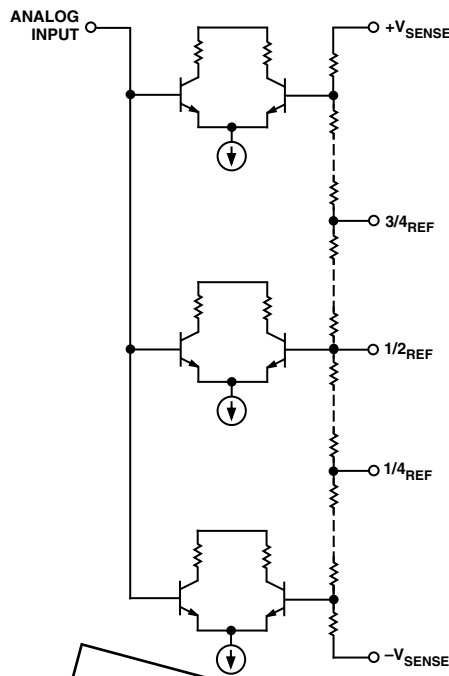

Figure 6. Equivalent Analog Input

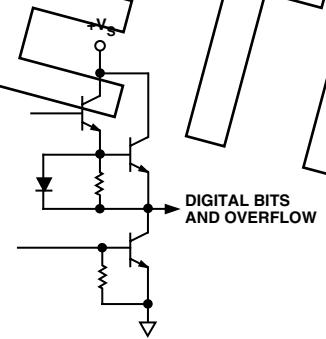

Figure 7. Equivalent Digital Outputs

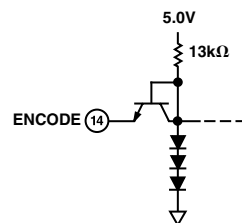

Figure 8. Equivalent Encode Circuit

AD9020

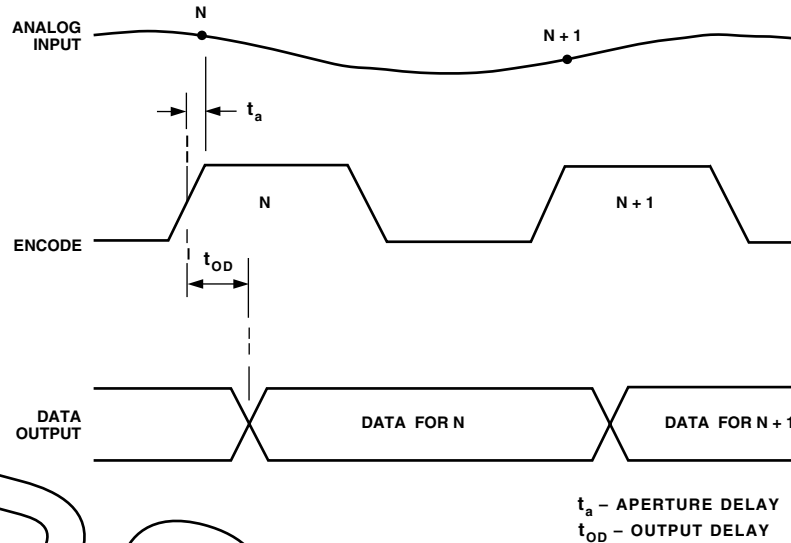

Figure 9. Timing Diagram

Timing

In the AD9020, the rising edge of the ENCODE signal triggers the A/D conversion by latching the comparators. (See Figure 9.)

The ENCODE is TTL/CMOS-compatible and should be driven from a low jitter (phase noise) source. Jitter on the ENCODE signal will raise the noise floor of the converter. Fast, clean edges will reduce the jitter in the signal and allow optimum ac performance. Locking the system clock to a crystal oscillator also helps reduce jitter. The AD9020 is designed to operate with a 50% duty cycle; small (10%) variations in duty cycle should not degrade performance.

Data Format

The format of the output data (D_0 – D_9) is controlled by the MSB INVERT and LSBs INVERT pins. These inputs are dc control inputs, and should be connected to GROUND or $+V_S$. Table I gives information to choose from among Binary, Inverted Binary, Two's Complement and Inverted Two's Complement coding.

The OVERFLOW output is an indication that the analog input signal has exceeded the voltage at $+V_{SENSE}$. The accuracy of the overflow transition voltage and output delay are not tested or included in the data sheet limits. Performance of the overflow indicator is dependent on circuit layout and slew rate of the encode signal. The operation of this function does not affect the other data bits (D_0 – D_9). It is not recommended for applications requiring a critical measure of the analog input voltage.

Layout and Power Supplies

Proper layout of high speed circuits is always critical but particularly important when both analog and digital signals are involved.

Analog signal paths should be kept as short as possible and be properly terminated to avoid reflections. The analog input voltage and the voltage references should be kept away from digital signal paths; this reduces the amount of digital switching noise that is capacitively coupled into the analog section of the circuit. Digital signal paths should also be kept short, and run lengths should be matched to avoid propagation delay mismatch.

In high-speed circuits, layout of the ground circuit is a critical factor. A single, low impedance ground plane, on the component side of the board, will reduce noise on the circuit ground. Power supplies should be capacitively coupled to the ground plane to reduce noise in the circuit. Multilayer boards allow designers to lay out signal traces without interrupting the ground plane and provide low impedance power planes.

It is especially important to maintain the continuity of the ground plane under and around the AD9020. In systems with dedicated digital and analog grounds, all grounds of the AD9020 should be connected to the analog ground plane.

The power supplies ($+V_S$ and $-V_S$) of the AD9020 should be isolated from the supplies used for external devices; this further reduces the amount of noise coupled into the A/D converter. Sockets limit the dynamic performance and should be used only for prototypes or evaluation—PCK Elastomers Part # CCS-68-55 is recommended for the LCC package.

An evaluation board is available to aid designers and provide a suggested layout.

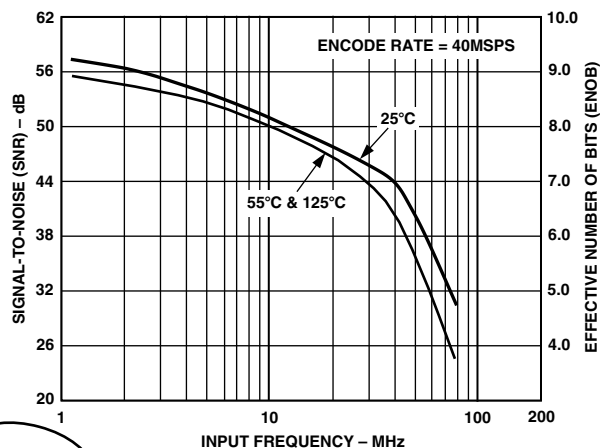

Figure 10. SNR and ENOB vs. Input Frequency

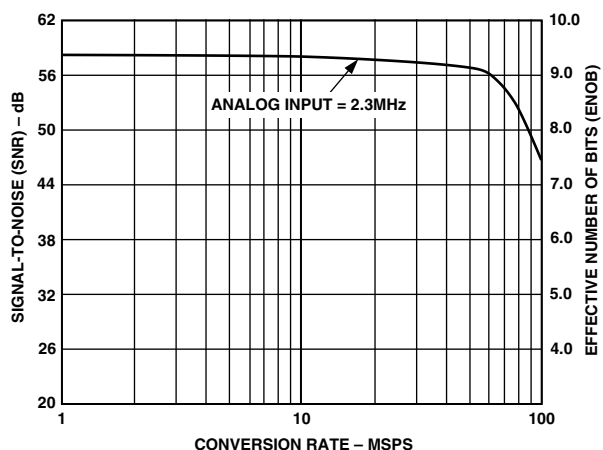

Figure 12. SNR and ENOB vs. Conversion Rate

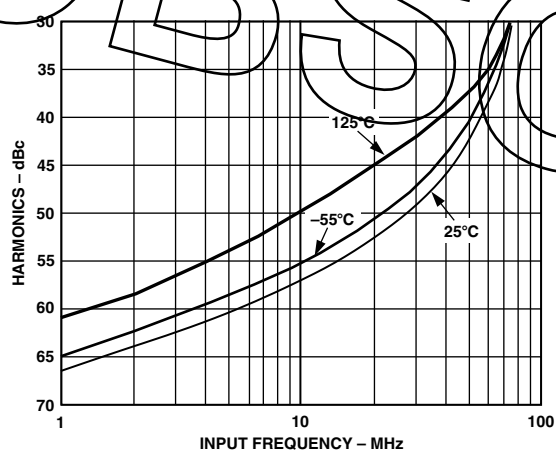

Figure 11. Harmonics vs. Input Frequency

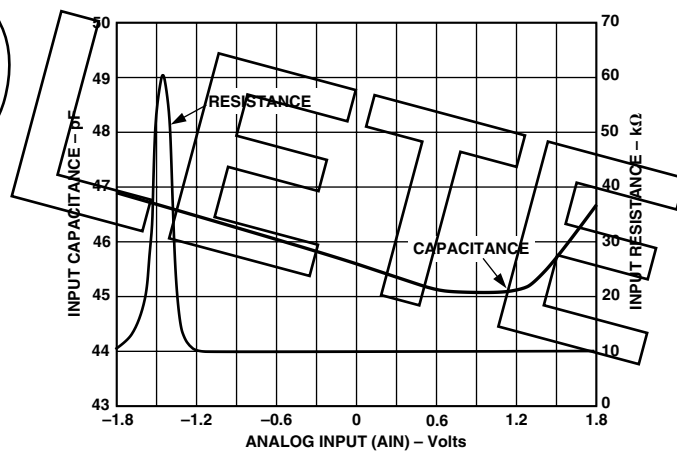

Figure 13. Input Capacitance/Resistance vs. Input Voltage

Table I. Truth Table

Step	Range 0 = -1.75 V FS = +1.75 V	Offset Binary		Two's Complement	
		True MSB INV = "0" LSBs INV = "0"	Inverted MSB INV = "1" LSBs INV = "1"	True MSB INV = "1" LSBs INV = "0"	Inverted MSB INV = "0" LSBs INV = "1"
1024	> +1.7500	(1)111111111	(1)000000000	(1)011111111	(1)100000000
1023	+1.7466	111111111	000000000	011111111	100000000
1022	+1.7432	111111110	000000001	011111110	100000001
⋮	⋮	⋮	⋮	⋮	⋮
512	+0.0034	100000000	011111111	000000000	111111111
511	0.000	011111111	100000000	111111111	000000000
510	-0.0034	011111110	100000001	111111110	000000001
⋮	⋮	⋮	⋮	⋮	⋮
⋮	⋮	⋮	⋮	⋮	⋮
⋮	⋮	⋮	⋮	⋮	⋮
02	-1.7432	000000010	111111101	100000010	011111101
01	-1.7466	000000001	111111110	100000001	011111110
00	<-1.7466	000000000	111111111	100000000	011111111

The overflow bit is always 0 except where noted in parentheses (). MSB INVERT and LSBs INVERT are considered dc controls.

AD9020

AD9020/PCB EVALUATION BOARD

The AD9020/PCB Evaluation Board is available from the factory and is shown here in block diagram form. The board includes a reference circuit that allows the user to adjust both references and the quarter-point voltages. The AD9617 is included as the drive amplifier, and the user can configure the gain from -1 to -15.

On-board reconstruction of the digital data is provided through the AD9713, a 12-bit monolithic DAC. The analog and reconstructed waveforms can be summed on the board to allow the user to observe the linearity of the AD9020 and the effects of the quarterpoint voltages. The digital data and an adjustable Data Ready signal are available through a 37-pin edge connector.

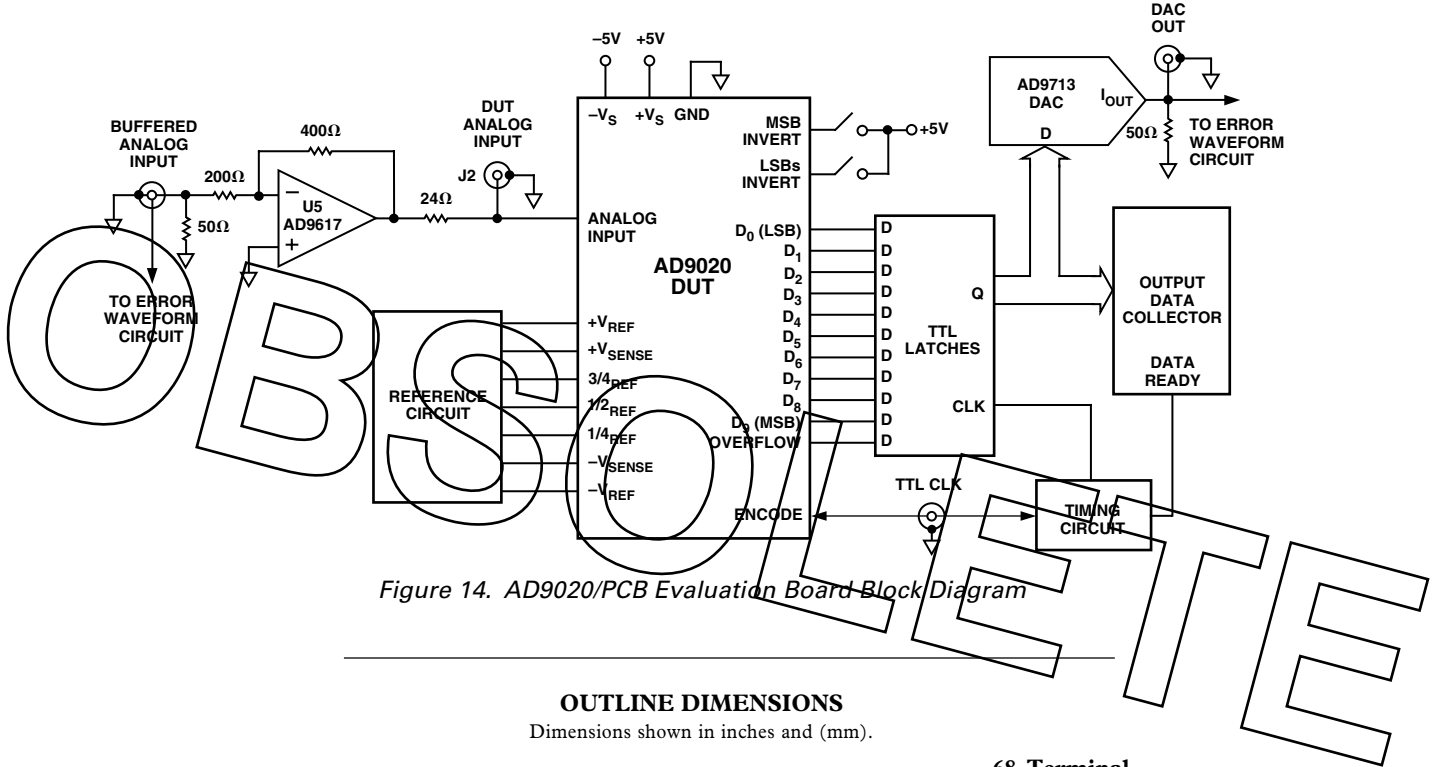
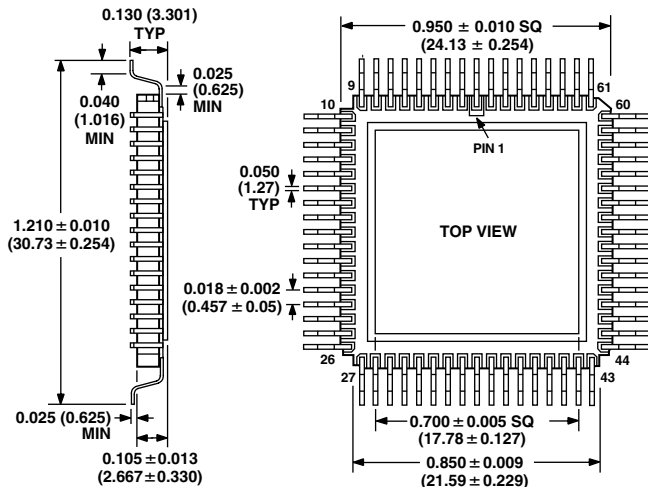

Figure 14. AD9020/PCB Evaluation Board Block Diagram

OUTLINE DIMENSIONS

Dimensions shown in inches and (mm).

68-Leaded Ceramic Chip Carrier (Z-68)



68-Terminal Leadless Chip Carrier (LCC) (E-68A)

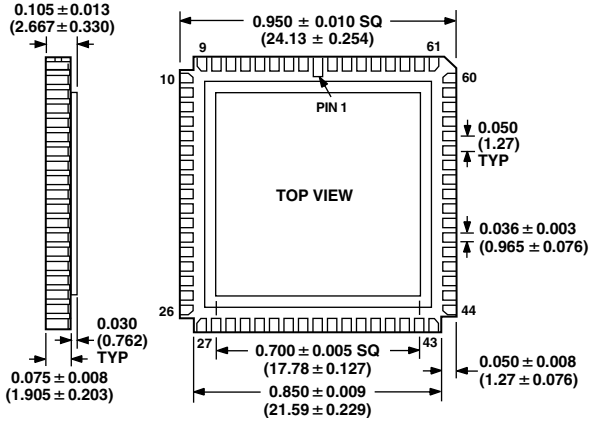

AD9020—Revision History

Location

Data Sheet changed from REV. B to REV. C.

Edit to ABSOLUTE MAXIMUM RATINGS

Page

2