



Main

Range of Product	Telemecanique Photoelectric sensors XU
Series name	General purpose single mode
Electronic sensor type	Photo-electric sensor
Sensor name	XUK
Sensor design	Compact 50 x 50
Detection system	Diffuse with background suppression
Material	Plastic
Type of output signal	Discrete
Supply circuit type	DC
Wiring Technique	3-wire
Discrete output type	PNP or NPN
Discrete output function	1 NO or 1 NC programmable
Electrical connection	1 male connector M12, 4 pins
Product Specific Application	-
Emission	Infrared laser, modulated diffuse with background suppression class 1
[Sn] nominal sensing distance	3.28 ft (1 m) diffuse with background suppression

Complementary

Enclosure Material	PC
Lens material	PMMA
Maximum sensing distance	3.28 ft (1 m) diffuse with background suppression
Minimum object diameter for detection	0.08 in (2 mm)
Output Type	Solid state
Wire insulation material	PVC
Status LED	1 LED yellow)output state 1 LED green)supply
[Us] rated supply voltage	12...24 V DC reverse polarity protection
Supply voltage limits	10...36 V DC
Switching capacity in mA	<= 100 mA (overload and short-circuit protection)
Switching frequency	<= 250 Hz
Maximum voltage drop	<1.5 V (closed state)
Current consumption	<= 30 mA (no-load)
Maximum delay first up	300 ms
Maximum delay response	2 ms
Maximum delay recovery	2 ms
Setting-up	Sensitivity adjustment by potentiometer
Depth	1.97 in (50 mm)
Height	1.97 in (50 mm)
Width	0.71 in (18 mm)
Net Weight	0.08 lb(US) (0.035 kg)
Kit composition	With XUZA51 bracket fixing

The information provided in this documentation contains general descriptions and/or technical characteristics of the performance of the products contained herein. This documentation is not intended as a substitute for and is not to be used for determining suitability or reliability of these products for specific user applications. It is the duty of any such user or integrator to perform the appropriate and complete risk analysis, evaluation and testing of the products with respect to the relevant specific application or use thereof. Neither Schneider Electric Industries SAS nor any of its affiliates or subsidiaries shall be responsible or liable for misuse of the information contained herein.

Environment

Product Certifications	CE Ecolab
Ambient air temperature for operation	-4...140 °F (-20...60 °C)
Ambient Air Temperature for Storage	-22...158 °F (-30...70 °C)
Vibration resistance	7 gn +/- 1.5 mm 10...55 Hz IEC 60068-2-6
Shock resistance	30 gn 11 ms) IEC 60068-2-27
IP degree of protection	IP65 double insulation IEC 60529

Ordering and shipping details

Category	22481 - SENSORS, PHOTOELECTRIC
Discount Schedule	DS2
GTIN	3389110057782
Nbr. of units in pkg.	1
Package weight(Lbs)	4.44 oz (126 g)
Returnability	Yes
Country of origin	ID

Packing Units

Unit Type of Package 1	PCE
Package 1 Height	1.57 in (4 cm)
Package 1 width	2.36 in (6 cm)
Package 1 Length	3.94 in (10 cm)
Unit Type of Package 2	S02
Number of Units in Package 2	30
Package 2 Weight	9.63 lb(US) (4.367 kg)
Package 2 Height	5.91 in (15 cm)
Package 2 width	11.81 in (30 cm)
Package 2 Length	15.75 in (40 cm)

Offer Sustainability

Sustainable offer status	Green Premium product
California proposition 65	WARNING: This product can expose you to chemicals including: Diisononyl phthalate (DINP), which is known to the State of California to cause cancer, and Di-isodecyl phthalate (DIDP), which is known to the State of California to cause birth defects or other reproductive harm. For more information go to www.P65Warnings.ca.gov
REACH Regulation	REACH Declaration
EU RoHS Directive	Pro-active compliance (Product out of EU RoHS legal scope) EU RoHS Declaration
Mercury free	Yes
RoHS exemption information	Yes
Environmental Disclosure	Product Environmental Profile
Circularity Profile	End Of Life Information

Contractual warranty

Warranty	18 months
----------	-----------

Dimensions

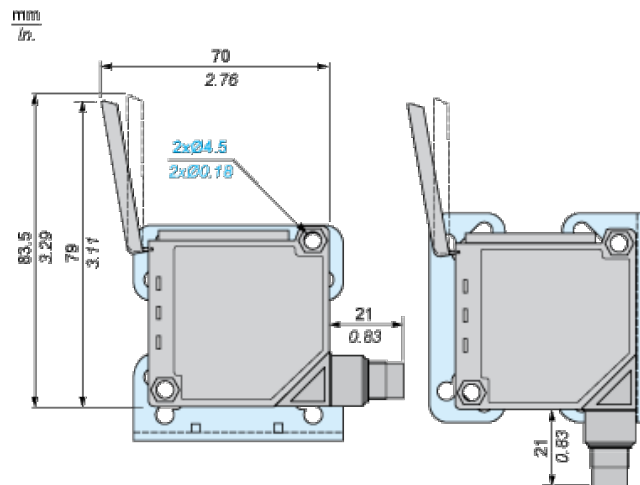

Bracket fixing

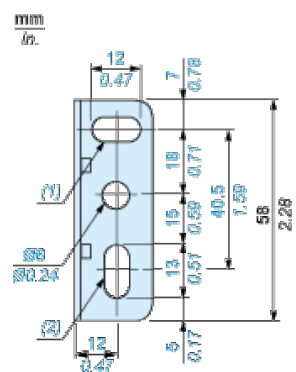

- (1) 1 elongated hole Ø 6 x 12
- (2) 1 elongated hole Ø 6 x 13

Wiring Schemes

Connector

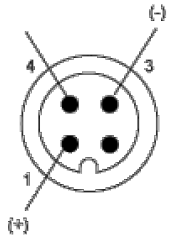

NO/NC programming

PNP Output

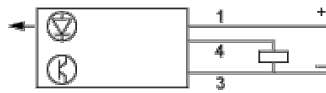

NPN Output

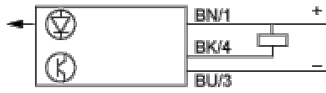

BN : Brown
BU : Blue
BK : Black

Detection Curves

Variation of Usable Sensing Distance S_u

Adjustment at 10 cm

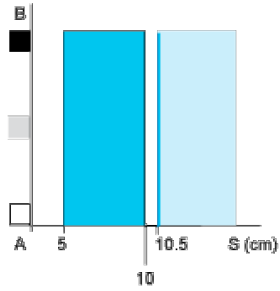

Adjustment at 1 m

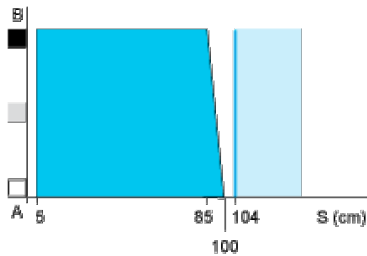

- (1) Black 6%
- (2) Grey 18%
- (3) White 90%
- (4) Sensing range
- (5) Non sensing zone (matt surfaces)

A-B : Object reflection coefficient

- (1) Black 6%
- (2) Grey 18%
- (3) White 90%
- (4) Sensing range
- (5) Non sensing zone (matt surfaces)

Sensing Distance Adjustment

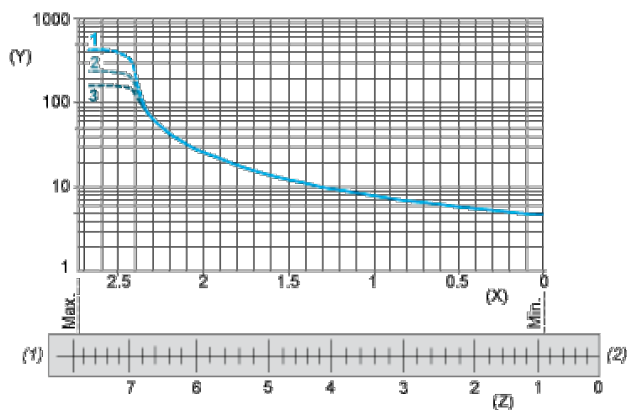

- 1 : White 90%
- 2 : Grey 18%
- 3 : Black 6%
- (Y) Sensing distance (cm)
- (X) Number of turns on potentiometer
- (Z) Setting indicator position (mm)

Relative Difference in Sensing Distances According to Object Colour

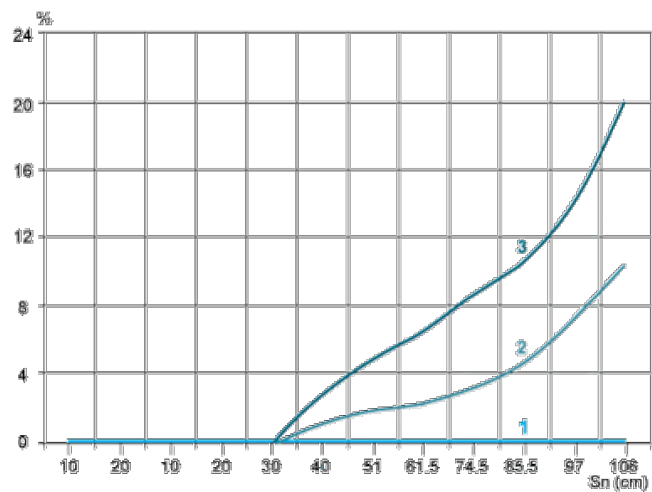

- 1 : White 90%
- 2 : Grey 18%
- 3 : Black 6%