

THIS DOCUMENT IS SUBJECT TO CHANGE WITHOUT NOTICE. IT IS CONFIDENTIAL AND A PROPERTY OF Amphenol LTW. DISCLOSURE TO THIRD PARTY HAS TO BE AUTHORIZED BY Amphenol LTW.

REV.	ECN NO.	DATE	SIGN	DESCRIPTION
E	C201472	2020/09/29	Vicky	△E X4
F	C210023	2021/01/14	Vicky	△E X2
G	C210309	2021/02/24	Ruru	△G X3

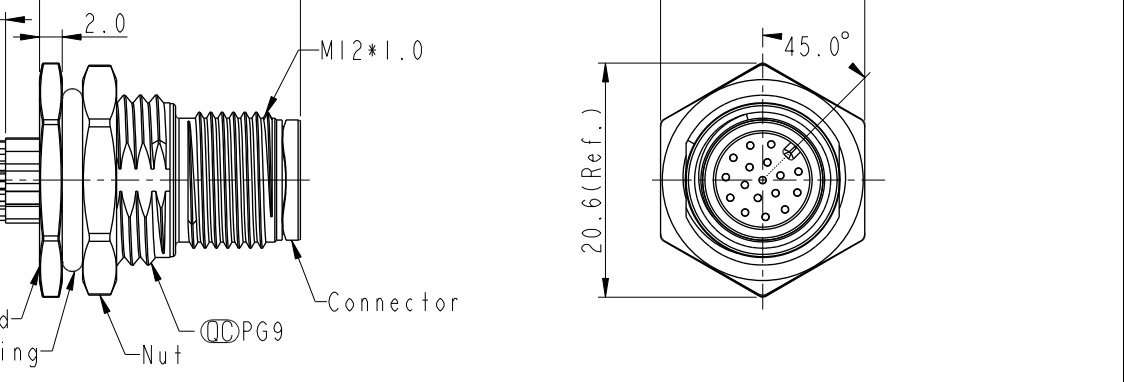

△E △G Note:

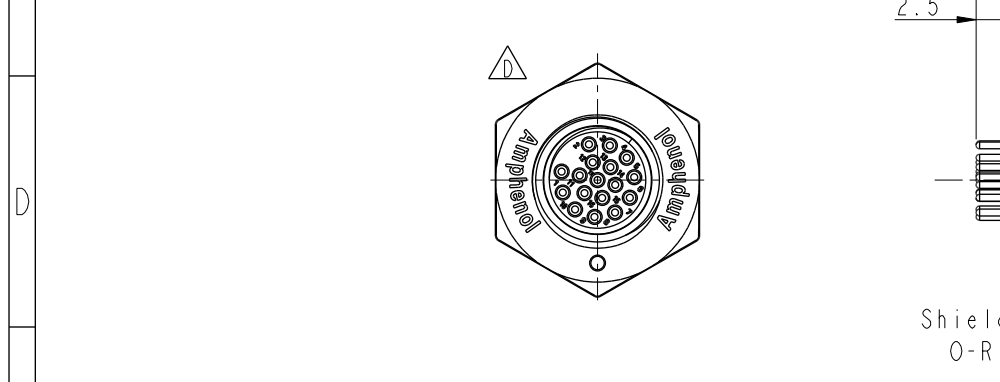
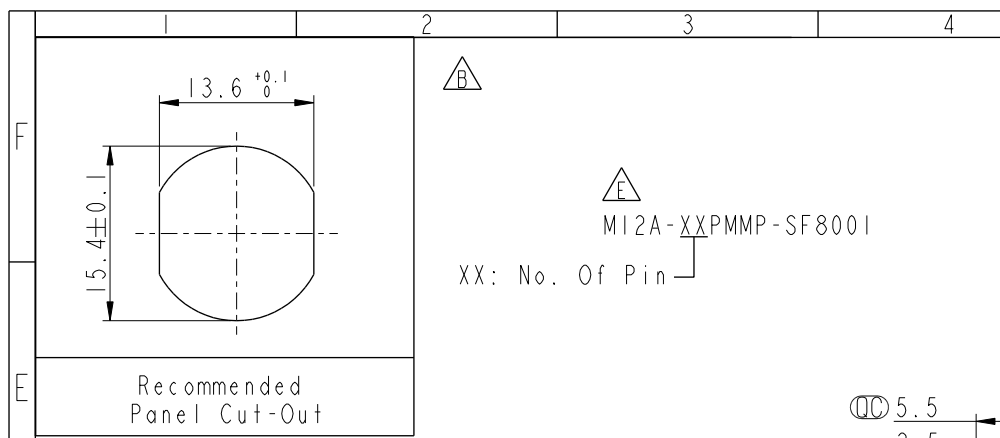

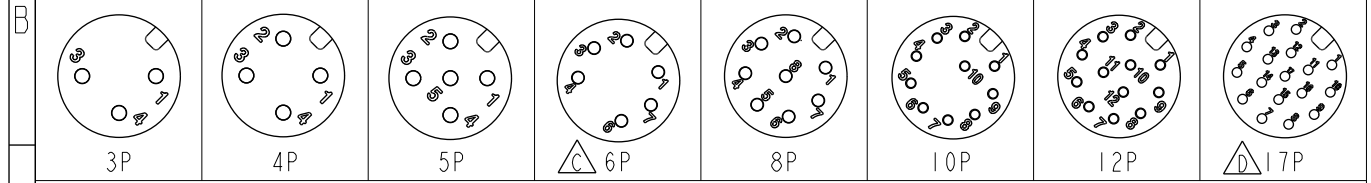

- * RoHS Compliant
- * \varnothing Important dimension
- * **△C** Waterproof rate: IPX8, unmated 1m/24h
IPX9K, unmated
- * Connector
- Housing: Thermoplastic, Black
- Pin: Copper alloy, Gold plated
- * **△E △F** Shield: Metal
- * **△E △F** Nut: Metal
- * O-Ring: Rubber, Black
- * For panel thickness max: 4.5mm
- * Nut is packed separately in pe bag

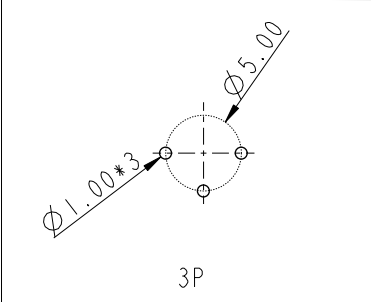
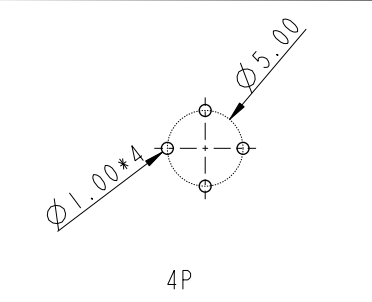
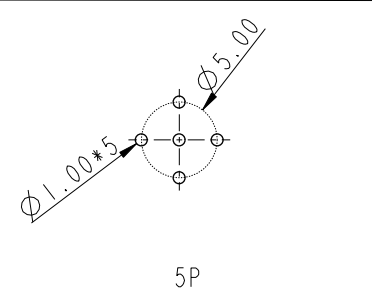
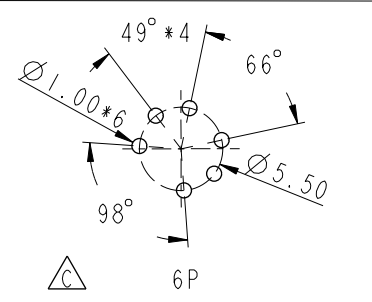
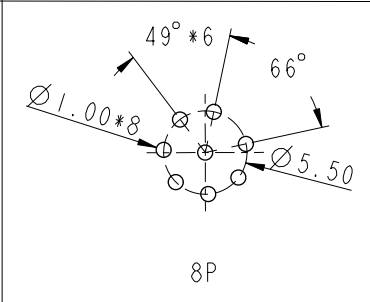
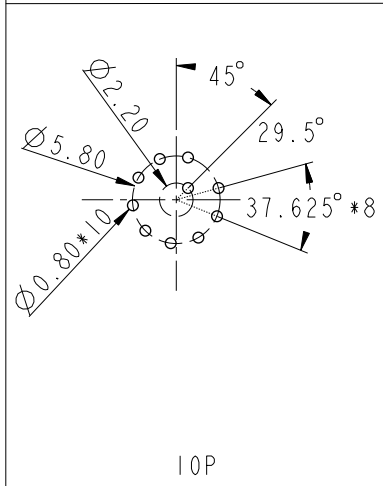
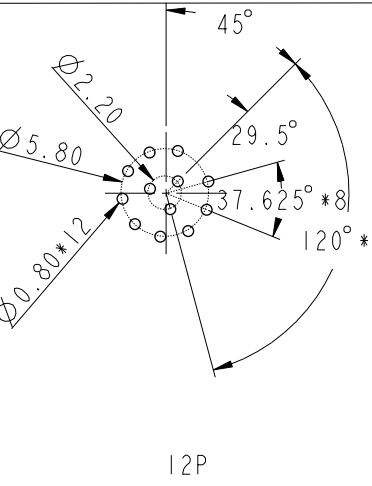
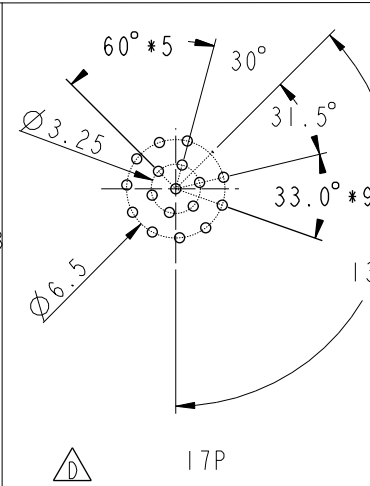

UNIT: mm			TITLE N SEN, M12 A, SCREW RECEPTACLE, M, M, PCB S △G
TOLERANCE .X ±0.25 .XX ±0.1 .XXX ±0.05 ANGLES ±1°	SCALE 2:1	SIZE A4	SHEET 1 OF 2
REV. G	WC-REV. A.5	\varnothing : Inspection item	

Amphenol LTW
安費諾亮泰企業股份有限公司

ITEM NO.	DRAWN BY Yulong_wang	DATE 2016-08-08
DWG NO. △E M12A-XXPMMP-SF8001	CHECKED BY Jinhai	DATE 2016-08-08
CUSTOMER ALTW	APPROVED BY Jerry	DATE 2016-08-08

F		2	3	4	5	6	7	8			
E											
D	PCB Layout										
C	 <p style="text-align: center;">3P</p>		 <p style="text-align: center;">4P</p>		 <p style="text-align: center;">5P</p>		 <p style="text-align: center;">6P</p>		 <p style="text-align: center;">8P</p>		
B	 <p style="text-align: center;">10P</p>				 <p style="text-align: center;">12P</p>			 <p style="text-align: center;">17P</p>			
A	UNIT: mm	 		TITLE N SEN, M12 A, SCREW RECEPTACLE, M, M, PCB S 			ITEM NO M12A-XXPMMP-SF8001		DRAWN BY Yulong_wang		DATE 2016-08-08
TOLERANCE .X ±0.25 .XX ±0.1 .XXX ±0.05 ANGLES ±1°		SCALE 2:1	SIZE A4	SHEET 2 OF 2		DWG NO M12A-XXPMMP-SF8001		CHECKED BY Jinhai		DATE 2016-08-08	
		REV. G	WC-REV. A.4	(CC): Inspection item		CUSTOMER ALTW		APPROVED BY Jerry		DATE 2016-08-08	
	2	3	4	5	6	7	8	8	W10814-03-001A2		

Amphenol LTW

安費諾亮泰企業股份有限公司