

SN54ALS805A, SN54AS805B, SN74ALS805A, SN74AS805B HEX 2-INPUT NOR DRIVERS

SDAS023C – DECEMBER 1982 – REVISED JANUARY 1995

- High Capacitive-Drive Capability
- 'ALS805A Has Typical Delay Time of 4.2 ns ($C_L = 50$ pF) and Typical Power Dissipation of 4.2 mW Per Gate
- 'AS805B Has Typical Delay Time of 2.6 ns ($C_L = 50$ pF) and Typical Power Dissipation of 12 mW Per Gate
- Package Options Include Plastic Small-Outline (DW) Packages, Ceramic Chip Carriers (FK), and Standard Plastic (N) and Ceramic (J) 300-mil DIPs

description

These devices contain six independent 2-input NOR drivers. They perform the Boolean functions $Y = A + B$ or $Y = \bar{A} \cdot \bar{B}$ in positive logic.

The SN54ALS805A and SN54AS805B are characterized for operation over the full military temperature range of -55°C to 125°C . The SN74ALS805A and SN74AS805B are characterized for operation from 0°C to 70°C .

FUNCTION TABLE
(each driver)

INPUTS		OUTPUT
A	B	Y
H	X	L
X	H	L
L	L	H

logic symbol†

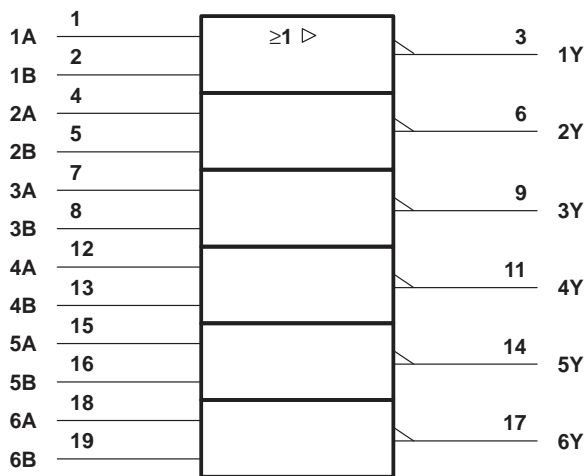

logic diagram (positive logic)

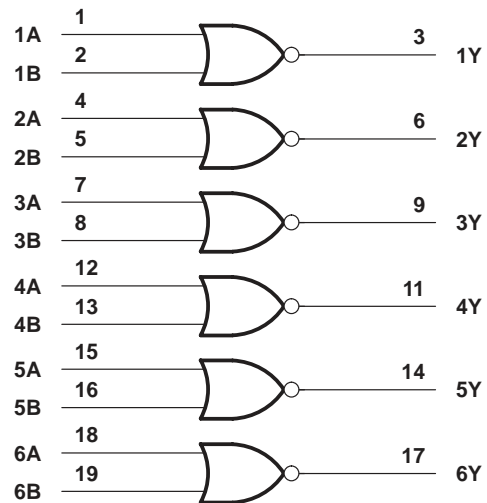

† This symbol is in accordance with ANSI/IEEE Std 91-1984 and IEC Publication 617-12.

SN54ALS805A, SN54AS805B . . . J PACKAGE
SN74ALS805A, SN74AS805B . . . DW OR N PACKAGE
(TOP VIEW)

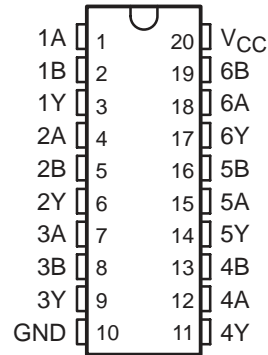

SN54ALS805A, SN54AS805B . . . FK PACKAGE
(TOP VIEW)

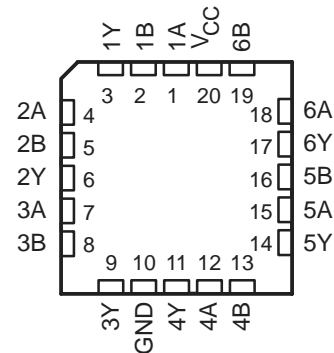

SN54ALS805A, SN54AS805B, SN74ALS805A, SN74AS805B HEX 2-INPUT NOR DRIVERS

SDAS023C – DECEMBER 1982 – REVISED JANUARY 1995

absolute maximum ratings over operating free-air temperature range (unless otherwise noted)†

Supply voltage, V_{CC}	7 V
Input voltage, V_I	7 V
Operating free-air temperature range, T_A : SN54ALS805A	-55°C to 125°C
SN74ALS805A	0°C to 70°C
Storage temperature range	-65°C to 150°C

† Stresses beyond those listed under "absolute maximum ratings" may cause permanent damage to the device. These are stress ratings only, and functional operation of the device at these or any other conditions beyond those indicated under "recommended operating conditions" is not implied. Exposure to absolute-maximum-rated conditions for extended periods may affect device reliability.

recommended operating conditions

		SN54ALS805A			SN74ALS805A			UNIT
		MIN	NOM	MAX	MIN	NOM	MAX	
V_{CC}	Supply voltage	4.5	5	5.5	4.5	5	5.5	V
V_{IH}	High-level input voltage	2			2			V
V_{IL}	Low-level input voltage			0.7			0.8	V
I_{OH}	High-level output current			-12			-15	mA
I_{OL}	Low-level output current			12			24	mA
T_A	Operating free-air temperature	-55		125	0		70	°C

electrical characteristics over recommended operating free-air temperature range (unless otherwise noted)

PARAMETER	TEST CONDITIONS	SN54ALS805A			SN74ALS805A			UNIT
		MIN	TYP‡	MAX	MIN	TYP‡	MAX	
V_{IK}	$V_{CC} = 4.5$ V, $I_I = -18$ mA			-1.2			-1.2	V
V_{OH}	$V_{CC} = 4.5$ V to 5.5 V, $I_{OH} = -0.4$ mA	$V_{CC} - 2$		$V_{CC} - 2$				V
	$V_{CC} = 4.5$ V	$I_{OH} = -3$ mA	2.4	3.2	2.4	3.2		
		$I_{OH} = -12$ mA	2		2			
V_{OL}	$V_{CC} = 4.5$ V	$I_{OL} = 12$ mA	0.25	0.4	0.25	0.4		V
		$I_{OL} = 24$ mA			0.35	0.5		
I_I	$V_{CC} = 5.5$ V, $V_I = 7$ V			0.1			0.1	mA
I_{IH}	$V_{CC} = 5.5$ V, $V_I = 2.7$ V			20			20	μA
I_{IL}	$V_{CC} = 5.5$ V, $V_I = 0.4$ V			-0.1			-0.1	mA
I_{O}^{\S}	$V_{CC} = 5.5$ V, $V_O = 2.25$ V	-20		-112	-30		-112	mA
I_{CCH}	$V_{CC} = 5.5$ V, $V_I = 0$		2	4	2	4		mA
I_{CCL}	$V_{CC} = 5.5$ V, $V_I = 4.5$ V		8	14	8	14		mA

‡ All typical values are at $V_{CC} = 5$ V, $T_A = 25^\circ\text{C}$.

§ The output conditions have been chosen to produce a current that closely approximates one half of the true short-circuit output current, I_{OS} .



SN54ALS805A, SN54AS805B, SN74ALS805A, SN74AS805B HEX 2-INPUT NOR DRIVERS

SDAS023C – DECEMBER 1982 – REVISED JANUARY 1995

switching characteristics (see Figure 1)

PARAMETER	FROM (INPUT)	TO (OUTPUT)	V _{CC} = 4.5 V to 5.5 V, C _L = 50 pF, R _L = 500 Ω, T _A = MIN to MAX†				UNIT
			SN54ALS805A		SN74ALS805A		
			MIN	MAX	MIN	MAX	
t _{PLH}	A or B	Y	1	12	2	7	ns
t _{PHL}			1	9	2	8	

† For conditions shown as MIN or MAX, use the appropriate value specified under recommended operating conditions.

absolute maximum ratings over operating free-air temperature range (unless otherwise noted)‡

Supply voltage, V _{CC}	7 V
Input voltage, V _I	7 V
Operating free-air temperature range, T _A : SN54AS805B	-55°C to 125°C
SN74AS805B	0°C to 70°C
Storage temperature range	-65°C to 150°C

‡ Stresses beyond those listed under "absolute maximum ratings" may cause permanent damage to the device. These are stress ratings only, and functional operation of the device at these or any other conditions beyond those indicated under "recommended operating conditions" is not implied. Exposure to absolute-maximum-rated conditions for extended periods may affect device reliability.

recommended operating conditions§

	SN54AS805B			SN74AS805B			UNIT
	MIN	NOM	MAX	MIN	NOM	MAX	
V _{CC} Supply voltage	4.5	5	5.5	4.5	5	5.5	V
V _{IH} High-level input voltage	2			2			V
V _{IL} Low-level input voltage			0.8			0.8	V
I _{OH} High-level output current			-40			-48	mA
I _{OL} Low-level output current			40			48	mA
T _A Operating free-air temperature	-55		125	0		70	°C

§ These high sink- or source-current devices are not recommended for use above 40 MHz.



SN54ALS805A, SN54AS805B, SN74ALS805A, SN74AS805B HEX 2-INPUT NOR DRIVERS

SDAS023C – DECEMBER 1982 – REVISED JANUARY 1995

electrical characteristics over recommended operating free-air temperature range (unless otherwise noted)

PARAMETER	TEST CONDITIONS		SN54AS805B			SN74AS805B			UNIT
			MIN	TYP†	MAX	MIN	TYP†	MAX	
V_{IK}	$V_{CC} = 4.5 V$,	$I_I = -18 mA$			-1.2			-1.2	V
V_{OH}	$V_{CC} = 4.5 V$ to $5.5 V$,	$I_{OH} = -2 mA$	$V_{CC} - 2$			$V_{CC} - 2$			V
	$V_{CC} = 4.5 V$	$I_{OH} = -3 mA$	2.4	3.2		2.4	3.2		
		$I_{OH} = -40 mA$	2			2			
V_{OL}	$V_{CC} = 4.5 V$	$I_{OL} = 40 mA$	0.25		0.5				V
		$I_{OL} = 48 mA$				0.35	0.5		
I_I	$V_{CC} = 5.5 V$,	$V_I = 7 V$			0.1			0.1	mA
I_{IH}	$V_{CC} = 5.5 V$,	$V_I = 2.7 V$			20			20	μA
I_{IL}	$V_{CC} = 5.5 V$,	$V_I = 0.4 V$			-0.5			-0.5	mA
$I_{O\ddagger}$	$V_{CC} = 5.5 V$,	$V_O = 2.25 V$	-50		-200	-50		-200	mA
I_{CCH}	$V_{CC} = 5.5 V$,	$V_I = 0$		6.5	10		6.5	10	mA
I_{CCL}	$V_{CC} = 5.5 V$,	$V_I = 4.5 V$		20	32		20	32	mA

† All typical values are at $V_{CC} = 5 V$, $T_A = 25^\circ C$.

‡ The output conditions have been chosen to produce a current that closely approximates one half of the true short-circuit output current, I_{OS} .

switching characteristics (see Figure 1)

PARAMETER	FROM (INPUT)	TO (OUTPUT)	$V_{CC} = 4.5 V$ to $5.5 V$, $C_L = 50 pF$, $R_L = 500 \Omega$, $T_A = MIN$ to MAX §				UNIT
			SN54AS805B		SN74AS805B		
			MIN	MAX	MIN	MAX	
t_{PLH}	A or B	Y	1	4.8	1	4.3	ns
t_{PHL}			1	4.8	1	4.3	

§ For conditions shown as MIN or MAX, use the appropriate value specified under recommended operating conditions.



PARAMETER MEASUREMENT INFORMATION
SERIES 54ALS/74ALS AND 54AS/74AS DEVICES

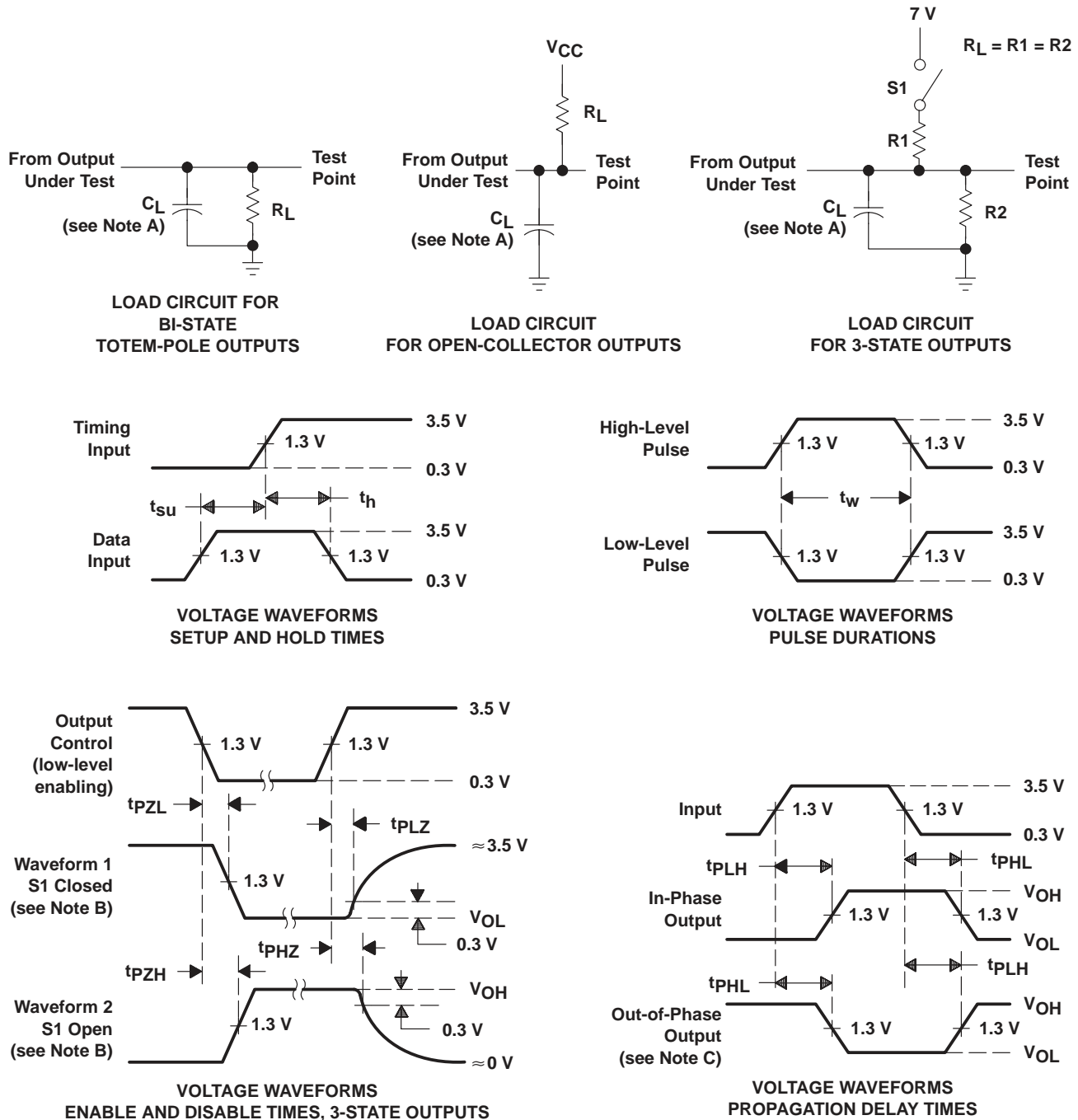

- NOTES: A. C_L includes probe and jig capacitance.
 B. Waveform 1 is for an output with internal conditions such that the output is low except when disabled by the output control. Waveform 2 is for an output with internal conditions such that the output is high except when disabled by the output control.
 C. When measuring propagation delay items of 3-state outputs, switch S1 is open.
 D. All input pulses have the following characteristics: $PRR \leq 1$ MHz, $t_r = t_f = 2$ ns, duty cycle = 50%.
 E. The outputs are measured one at a time with one transition per measurement.

Figure 1. Load Circuits and Voltage Waveforms

PACKAGING INFORMATION

Orderable Device	Status (1)	Package Type	Package Drawing	Pins	Package Qty	Eco Plan (2)	Lead/Ball Finish (6)	MSL Peak Temp (3)	Op Temp (°C)	Device Marking (4/5)	Samples
5962-87794012A	ACTIVE	LCCC	FK	20	1	TBD	POST-PLATE	N / A for Pkg Type	-55 to 125	5962- 87794012A SNJ54AS 805BFK	Samples
5962-8869401SA	OBSOLETE	CFP	W	20		TBD	Call TI	Call TI	-55 to 125		
SN54ALS805AJ	OBSOLETE	CDIP	J	20		TBD	Call TI	Call TI	-55 to 125		
SN74ALS805ADWR	OBSOLETE	SOIC	DW	20		TBD	Call TI	Call TI	0 to 70		
SN74ALS805ADWRE4	OBSOLETE	SOIC	DW	20		TBD	Call TI	Call TI	0 to 70		
SN74ALS805ADWRG4	OBSOLETE	SOIC	DW	20		TBD	Call TI	Call TI	0 to 70		
SN74ALS805AN3	OBSOLETE	PDIP	N	20		TBD	Call TI	Call TI	0 to 70		
SN74AS805BDW	OBSOLETE	SOIC	DW	20		TBD	Call TI	Call TI	0 to 70	AS805B	
SN74AS805BN	OBSOLETE	PDIP	N	20		TBD	Call TI	Call TI	0 to 70	SN74AS805BN	
SNJ54ALS805AFK	OBSOLETE	LCCC	FK	20		TBD	Call TI	Call TI	-55 to 125		
SNJ54ALS805AJ	OBSOLETE	CDIP	J	20		TBD	Call TI	Call TI	-55 to 125		
SNJ54AS805BFK	ACTIVE	LCCC	FK	20	1	TBD	POST-PLATE	N / A for Pkg Type	-55 to 125	5962- 87794012A SNJ54AS 805BFK	Samples

(1) The marketing status values are defined as follows:

ACTIVE: Product device recommended for new designs.

LIFEBUY: TI has announced that the device will be discontinued, and a lifetime-buy period is in effect.

NRND: Not recommended for new designs. Device is in production to support existing customers, but TI does not recommend using this part in a new design.

PREVIEW: Device has been announced but is not in production. Samples may or may not be available.

OBSOLETE: TI has discontinued the production of the device.

(2) Eco Plan - The planned eco-friendly classification: Pb-Free (RoHS), Pb-Free (RoHS Exempt), or Green (RoHS & no Sb/Br) - please check <http://www.ti.com/productcontent> for the latest availability information and additional product content details.

TBD: The Pb-Free/Green conversion plan has not been defined.

Pb-Free (RoHS): TI's terms "Lead-Free" or "Pb-Free" mean semiconductor products that are compatible with the current RoHS requirements for all 6 substances, including the requirement that lead not exceed 0.1% by weight in homogeneous materials. Where designed to be soldered at high temperatures, TI Pb-Free products are suitable for use in specified lead-free processes.

Pb-Free (RoHS Exempt): This component has a RoHS exemption for either 1) lead-based flip-chip solder bumps used between the die and package, or 2) lead-based die adhesive used between the die and leadframe. The component is otherwise considered Pb-Free (RoHS compatible) as defined above.

Green (RoHS & no Sb/Br): TI defines "Green" to mean Pb-Free (RoHS compatible), and free of Bromine (Br) and Antimony (Sb) based flame retardants (Br or Sb do not exceed 0.1% by weight in homogeneous material)

- (3) MSL, Peak Temp. - The Moisture Sensitivity Level rating according to the JEDEC industry standard classifications, and peak solder temperature.
- (4) There may be additional marking, which relates to the logo, the lot trace code information, or the environmental category on the device.
- (5) Multiple Device Markings will be inside parentheses. Only one Device Marking contained in parentheses and separated by a "~" will appear on a device. If a line is indented then it is a continuation of the previous line and the two combined represent the entire Device Marking for that device.
- (6) Lead/Ball Finish - Orderable Devices may have multiple material finish options. Finish options are separated by a vertical ruled line. Lead/Ball Finish values may wrap to two lines if the finish value exceeds the maximum column width.

Important Information and Disclaimer:The information provided on this page represents TI's knowledge and belief as of the date that it is provided. TI bases its knowledge and belief on information provided by third parties, and makes no representation or warranty as to the accuracy of such information. Efforts are underway to better integrate information from third parties. TI has taken and continues to take reasonable steps to provide representative and accurate information but may not have conducted destructive testing or chemical analysis on incoming materials and chemicals. TI and TI suppliers consider certain information to be proprietary, and thus CAS numbers and other limited information may not be available for release.

In no event shall TI's liability arising out of such information exceed the total purchase price of the TI part(s) at issue in this document sold by TI to Customer on an annual basis.

OTHER QUALIFIED VERSIONS OF SN54ALS805A, SN54AS805B, SN74ALS805A, SN74AS805B :

- Catalog: [SN74ALS805A](#), [SN74AS805B](#)
- Military: [SN54ALS805A](#), [SN54AS805B](#)

NOTE: Qualified Version Definitions:

- Catalog - TI's standard catalog product
- Military - QML certified for Military and Defense Applications

FK (S-CQCC-N**)

LEADLESS CERAMIC CHIP CARRIER

28 TERMINAL SHOWN

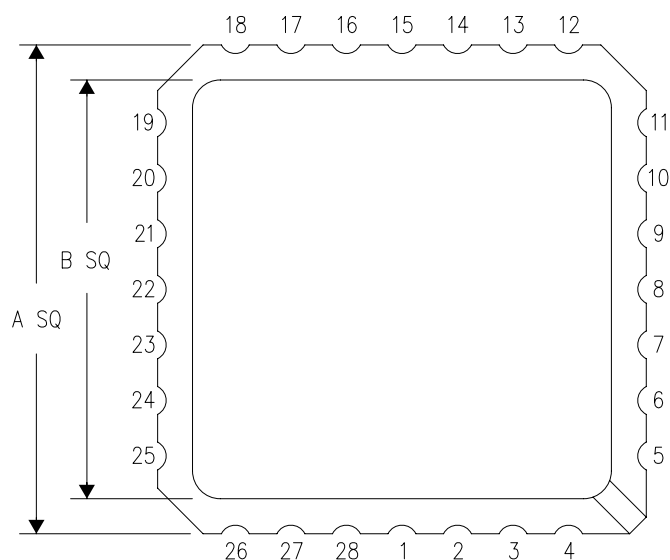

NO. OF TERMINALS **	A		B	
	MIN	MAX	MIN	MAX
20	0.342 (8,69)	0.358 (9,09)	0.307 (7,80)	0.358 (9,09)
28	0.442 (11,23)	0.458 (11,63)	0.406 (10,31)	0.458 (11,63)
44	0.640 (16,26)	0.660 (16,76)	0.495 (12,58)	0.560 (14,22)
52	0.740 (18,78)	0.761 (19,32)	0.495 (12,58)	0.560 (14,22)
68	0.938 (23,83)	0.962 (24,43)	0.850 (21,6)	0.858 (21,8)
84	1.141 (28,99)	1.165 (29,59)	1.047 (26,6)	1.063 (27,0)

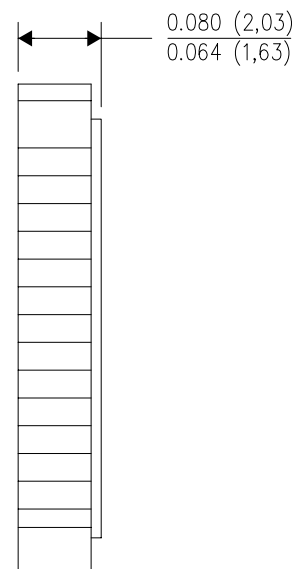
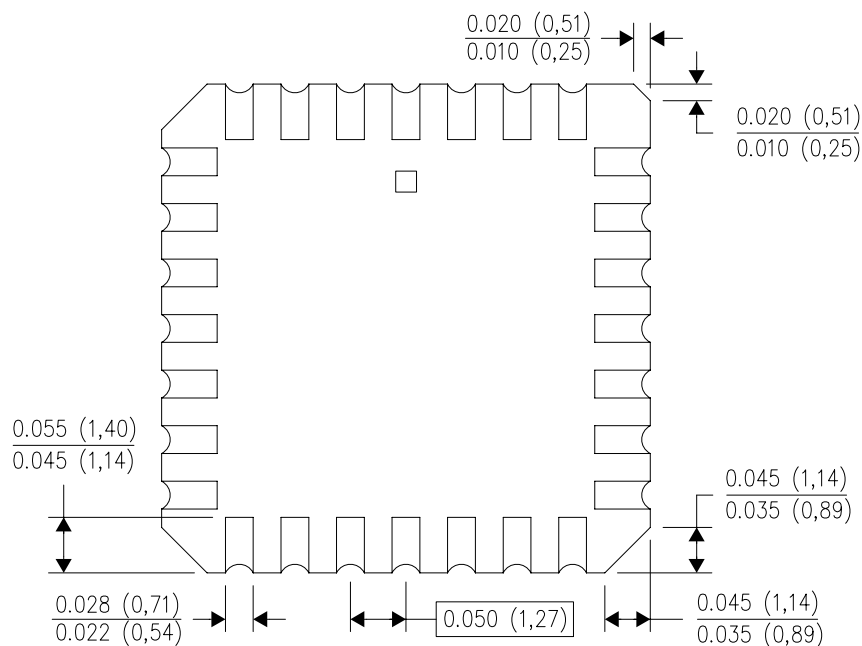

4040140/D 01/11

- NOTES:
- All linear dimensions are in inches (millimeters).
 - This drawing is subject to change without notice.
 - This package can be hermetically sealed with a metal lid.
 - Falls within JEDEC MS-004

J (R-GDIP-T**)

14 LEADS SHOWN

CERAMIC DUAL IN-LINE PACKAGE

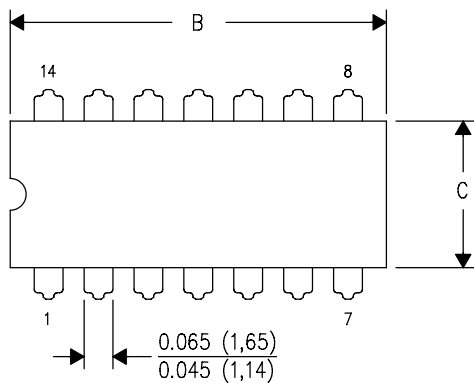

DIM \ PINS **	14	16	18	20
A	0.300 (7,62) BSC	0.300 (7,62) BSC	0.300 (7,62) BSC	0.300 (7,62) BSC
B MAX	0.785 (19,94)	.840 (21,34)	0.960 (24,38)	1.060 (26,92)
B MIN	—	—	—	—
C MAX	0.300 (7,62)	0.300 (7,62)	0.310 (7,87)	0.300 (7,62)
C MIN	0.245 (6,22)	0.245 (6,22)	0.220 (5,59)	0.245 (6,22)

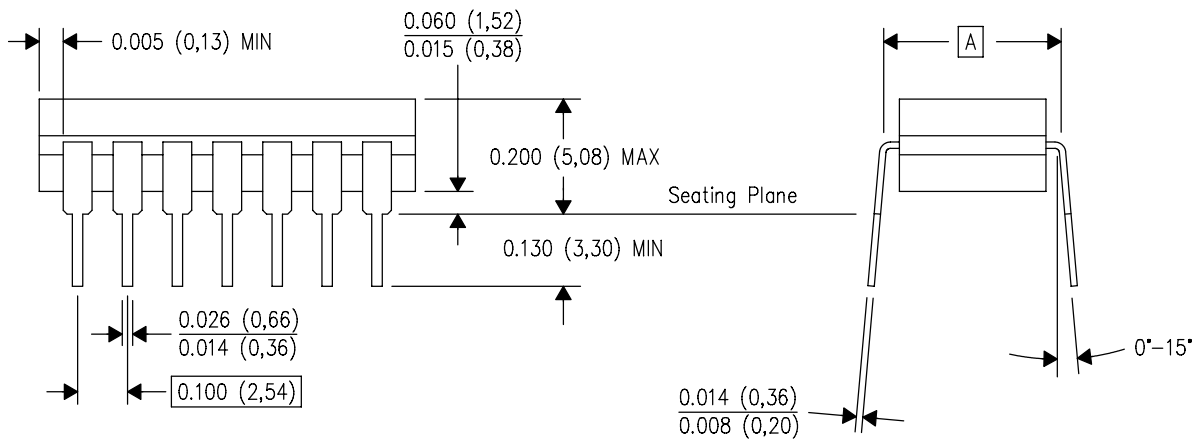

4040083/F 03/03

- NOTES:
- All linear dimensions are in inches (millimeters).
 - This drawing is subject to change without notice.
 - This package is hermetically sealed with a ceramic lid using glass frit.
 - Index point is provided on cap for terminal identification only on press ceramic glass frit seal only.
 - Falls within MIL STD 1835 GDIP1-T14, GDIP1-T16, GDIP1-T18 and GDIP1-T20.

N (R-PDIP-T**)

PLASTIC DUAL-IN-LINE PACKAGE

16 PINS SHOWN

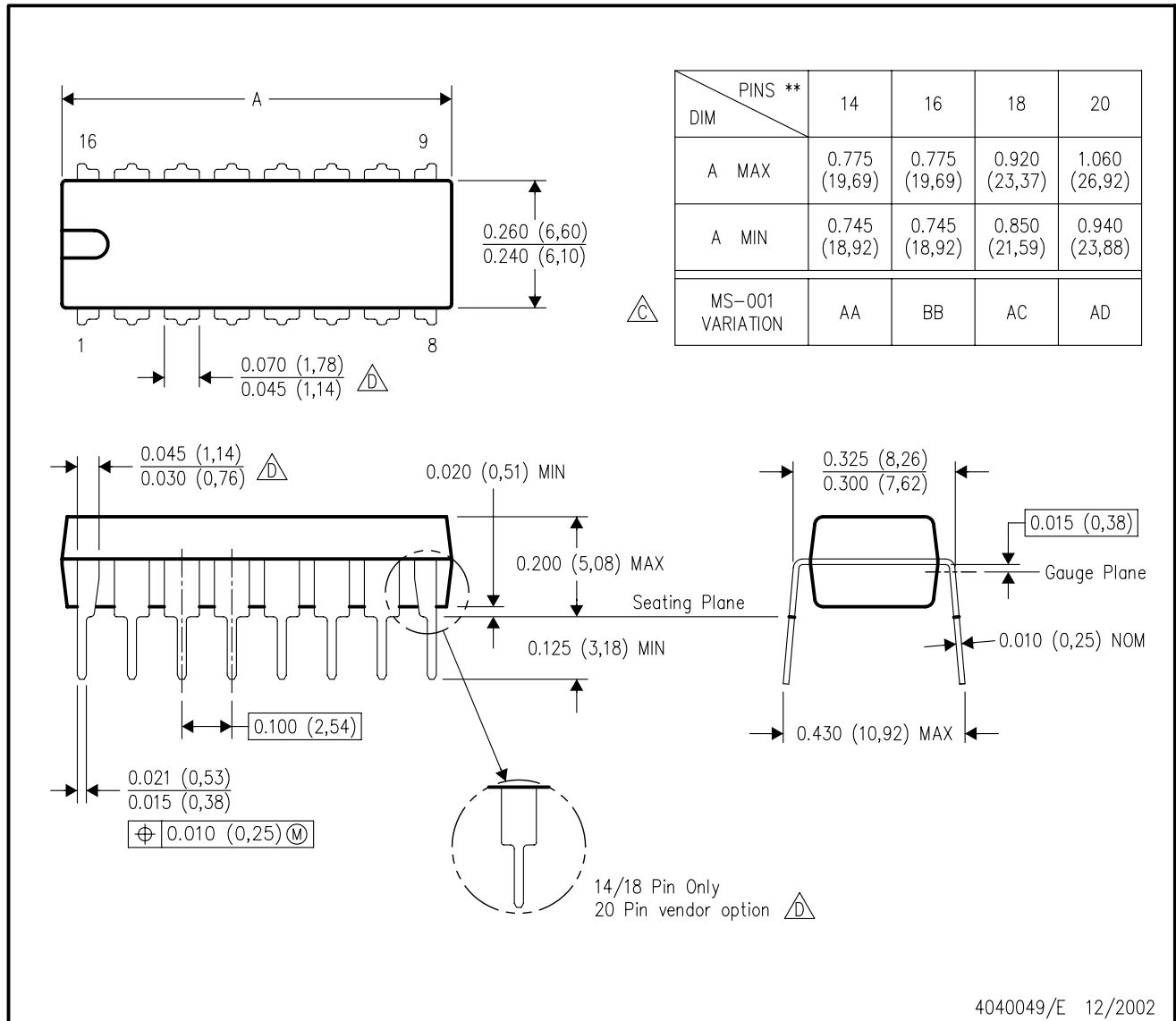

- NOTES:
- A. All linear dimensions are in inches (millimeters).
 - B. This drawing is subject to change without notice.
 - $\triangle C$ Falls within JEDEC MS-001, except 18 and 20 pin minimum body length (Dim A).
 - $\triangle D$ The 20 pin end lead shoulder width is a vendor option, either half or full width.

4040049/E 12/2002

DW0020A



PACKAGE OUTLINE

SOIC - 2.65 mm max height

SOIC

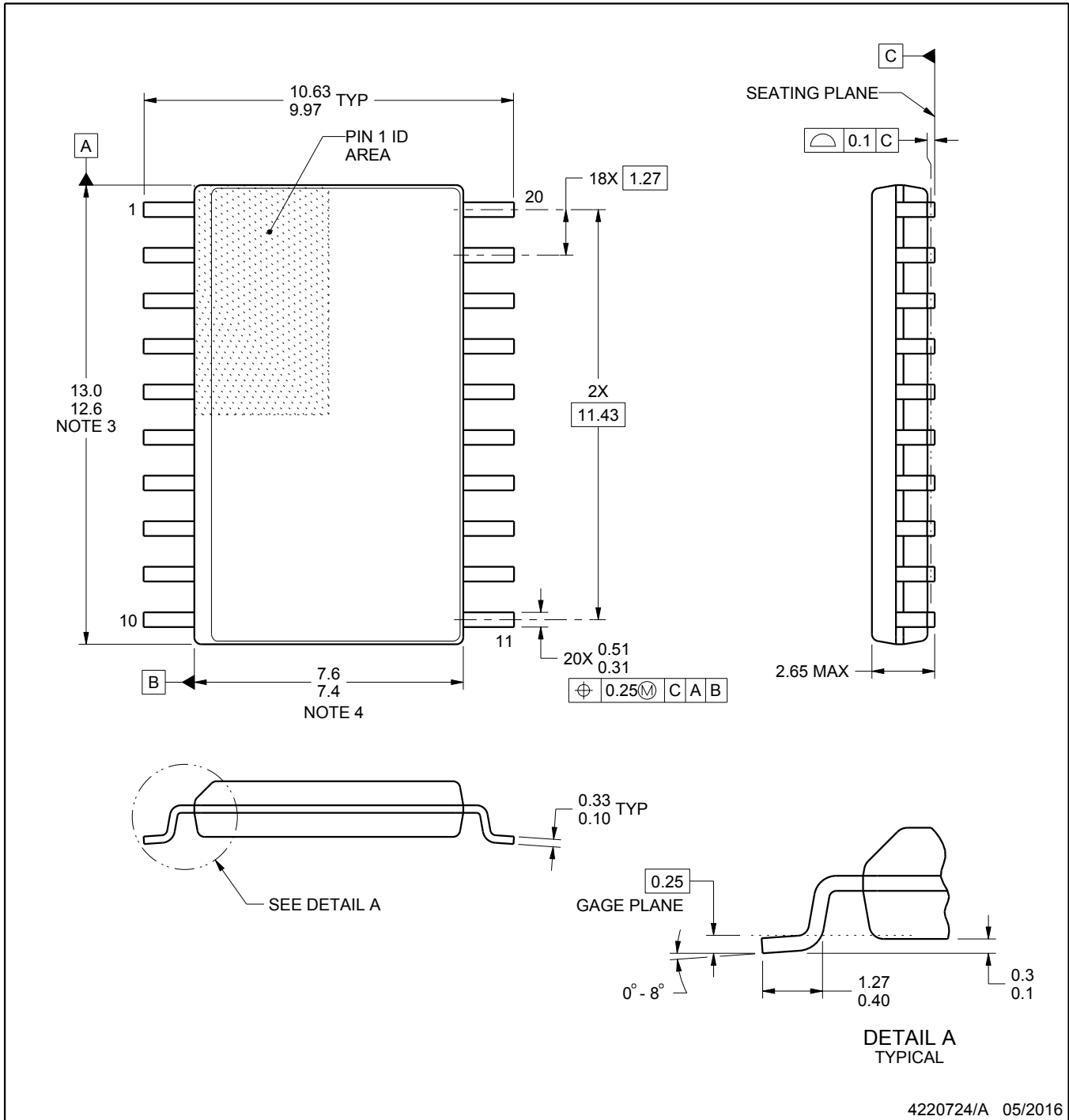

4220724/A 05/2016

EXAMPLE BOARD LAYOUT

DW0020A

SOIC - 2.65 mm max height

SOIC

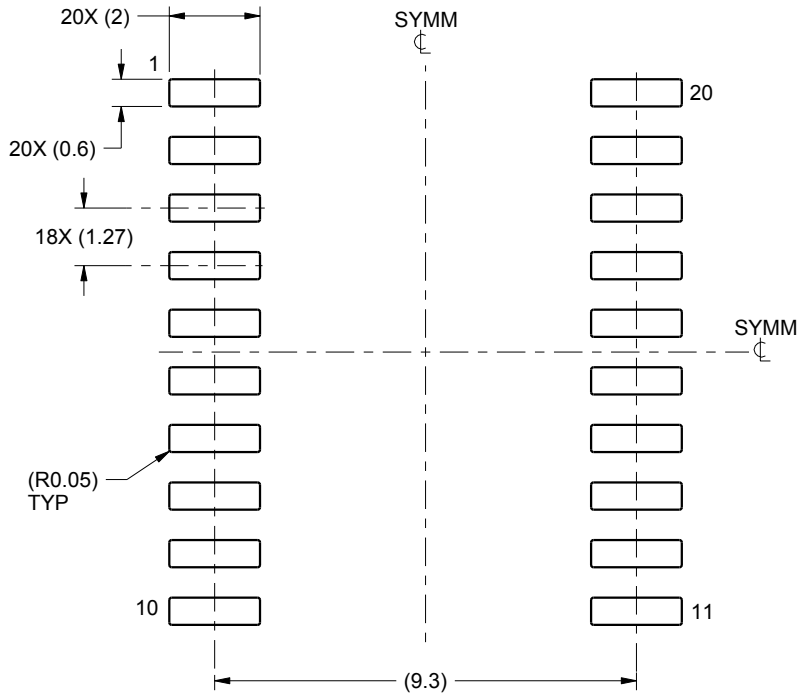

LAND PATTERN EXAMPLE
SCALE:6X

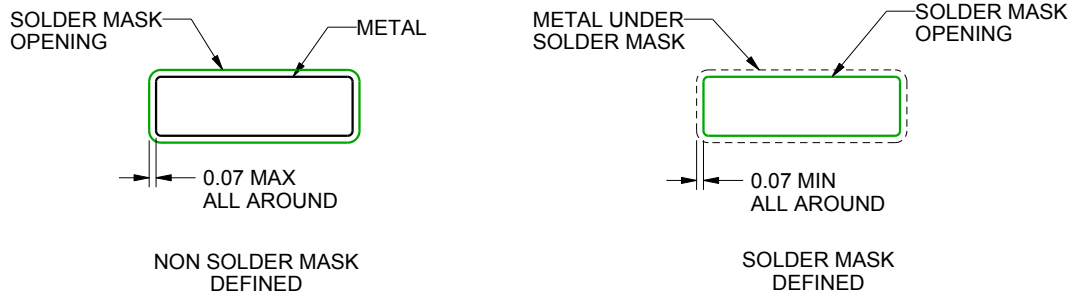

SOLDER MASK DETAILS

4220724/A 05/2016

NOTES: (continued)

- 6. Publication IPC-7351 may have alternate designs.
- 7. Solder mask tolerances between and around signal pads can vary based on board fabrication site.

EXAMPLE STENCIL DESIGN

DW0020A

SOIC - 2.65 mm max height

SOIC

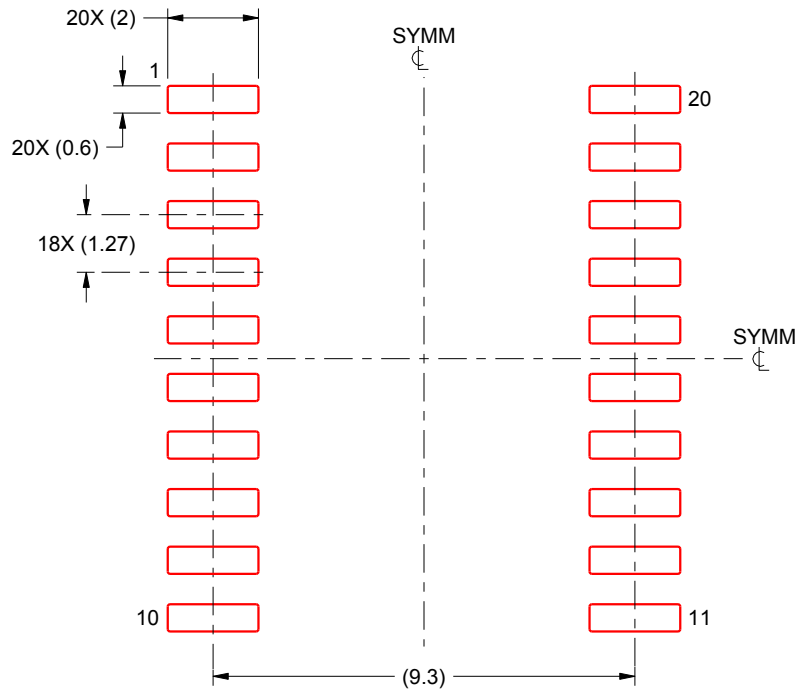

SOLDER PASTE EXAMPLE
BASED ON 0.125 mm THICK STENCIL
SCALE:6X

4220724/A 05/2016

NOTES: (continued)

8. Laser cutting apertures with trapezoidal walls and rounded corners may offer better paste release. IPC-7525 may have alternate design recommendations.
9. Board assembly site may have different recommendations for stencil design.

W (R-GDFP-F20)

CERAMIC DUAL FLATPACK

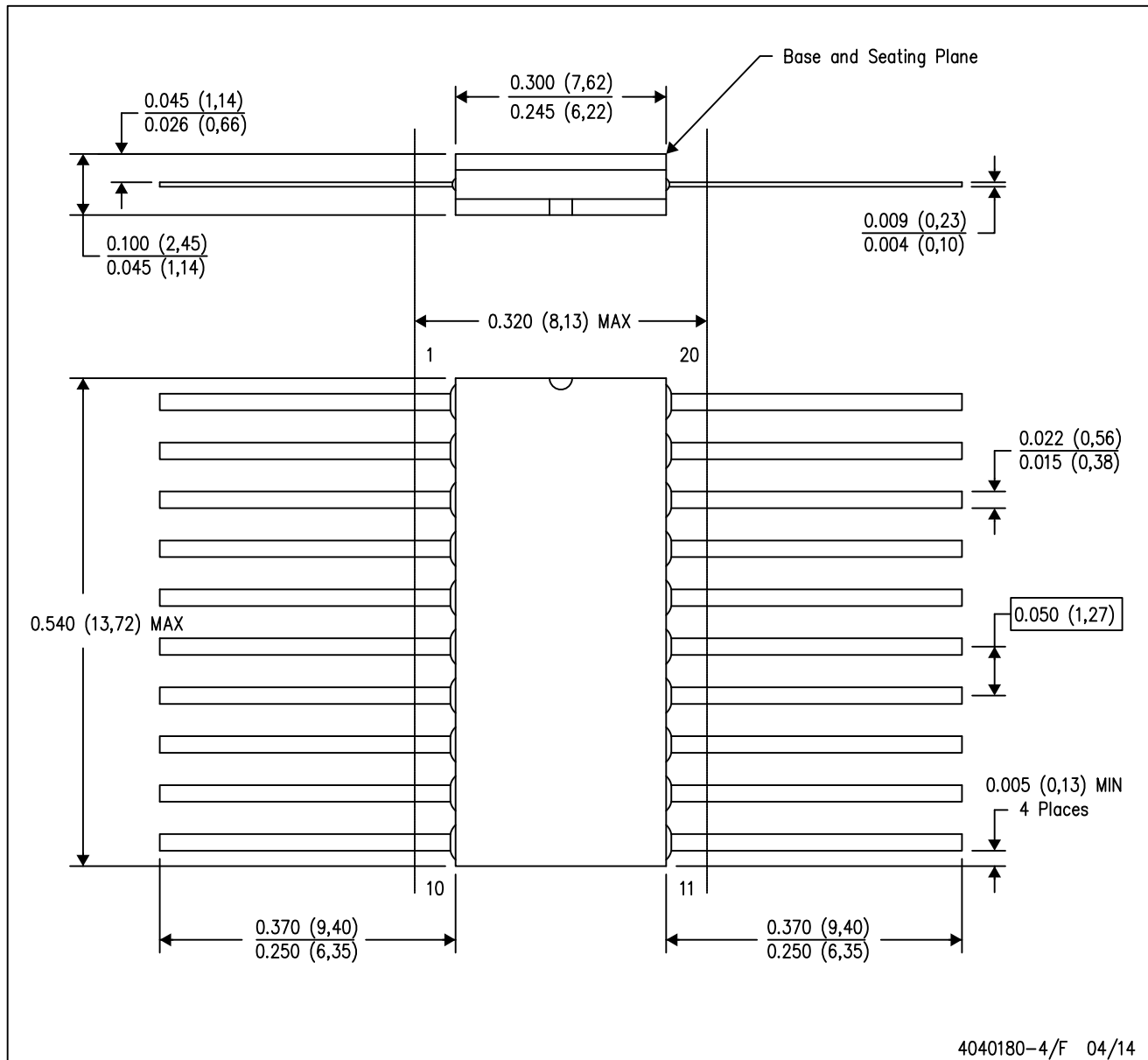

- NOTES:
- A. All linear dimensions are in inches (millimeters).
 - B. This drawing is subject to change without notice.
 - C. This package can be hermetically sealed with a ceramic lid using glass frit.
 - D. Index point is provided on cap for terminal identification only.
 - E. Falls within Mil-Std 1835 GDFP2-F20

IMPORTANT NOTICE

Texas Instruments Incorporated and its subsidiaries (TI) reserve the right to make corrections, enhancements, improvements and other changes to its semiconductor products and services per JESD46, latest issue, and to discontinue any product or service per JESD48, latest issue. Buyers should obtain the latest relevant information before placing orders and should verify that such information is current and complete. All semiconductor products (also referred to herein as "components") are sold subject to TI's terms and conditions of sale supplied at the time of order acknowledgment.

TI warrants performance of its components to the specifications applicable at the time of sale, in accordance with the warranty in TI's terms and conditions of sale of semiconductor products. Testing and other quality control techniques are used to the extent TI deems necessary to support this warranty. Except where mandated by applicable law, testing of all parameters of each component is not necessarily performed.

TI assumes no liability for applications assistance or the design of Buyers' products. Buyers are responsible for their products and applications using TI components. To minimize the risks associated with Buyers' products and applications, Buyers should provide adequate design and operating safeguards.

TI does not warrant or represent that any license, either express or implied, is granted under any patent right, copyright, mask work right, or other intellectual property right relating to any combination, machine, or process in which TI components or services are used. Information published by TI regarding third-party products or services does not constitute a license to use such products or services or a warranty or endorsement thereof. Use of such information may require a license from a third party under the patents or other intellectual property of the third party, or a license from TI under the patents or other intellectual property of TI.

Reproduction of significant portions of TI information in TI data books or data sheets is permissible only if reproduction is without alteration and is accompanied by all associated warranties, conditions, limitations, and notices. TI is not responsible or liable for such altered documentation. Information of third parties may be subject to additional restrictions.

Resale of TI components or services with statements different from or beyond the parameters stated by TI for that component or service voids all express and any implied warranties for the associated TI component or service and is an unfair and deceptive business practice. TI is not responsible or liable for any such statements.

Buyer acknowledges and agrees that it is solely responsible for compliance with all legal, regulatory and safety-related requirements concerning its products, and any use of TI components in its applications, notwithstanding any applications-related information or support that may be provided by TI. Buyer represents and agrees that it has all the necessary expertise to create and implement safeguards which anticipate dangerous consequences of failures, monitor failures and their consequences, lessen the likelihood of failures that might cause harm and take appropriate remedial actions. Buyer will fully indemnify TI and its representatives against any damages arising out of the use of any TI components in safety-critical applications.

In some cases, TI components may be promoted specifically to facilitate safety-related applications. With such components, TI's goal is to help enable customers to design and create their own end-product solutions that meet applicable functional safety standards and requirements. Nonetheless, such components are subject to these terms.

No TI components are authorized for use in FDA Class III (or similar life-critical medical equipment) unless authorized officers of the parties have executed a special agreement specifically governing such use.

Only those TI components which TI has specifically designated as military grade or "enhanced plastic" are designed and intended for use in military/aerospace applications or environments. Buyer acknowledges and agrees that any military or aerospace use of TI components which have **not** been so designated is solely at the Buyer's risk, and that Buyer is solely responsible for compliance with all legal and regulatory requirements in connection with such use.

TI has specifically designated certain components as meeting ISO/TS16949 requirements, mainly for automotive use. In any case of use of non-designated products, TI will not be responsible for any failure to meet ISO/TS16949.

Products

Audio	www.ti.com/audio
Amplifiers	amplifier.ti.com
Data Converters	dataconverter.ti.com
DLP® Products	www.dlp.com
DSP	dsp.ti.com
Clocks and Timers	www.ti.com/clocks
Interface	interface.ti.com
Logic	logic.ti.com
Power Mgmt	power.ti.com
Microcontrollers	microcontroller.ti.com
RFID	www.ti-rfid.com
OMAP Applications Processors	www.ti.com/omap
Wireless Connectivity	www.ti.com/wirelessconnectivity

Applications

Automotive and Transportation	www.ti.com/automotive
Communications and Telecom	www.ti.com/communications
Computers and Peripherals	www.ti.com/computers
Consumer Electronics	www.ti.com/consumer-apps
Energy and Lighting	www.ti.com/energy
Industrial	www.ti.com/industrial
Medical	www.ti.com/medical
Security	www.ti.com/security
Space, Avionics and Defense	www.ti.com/space-avionics-defense
Video and Imaging	www.ti.com/video

TI E2E Community

e2e.ti.com