

PATRZ UWAGA 1
SEE NOTE 1

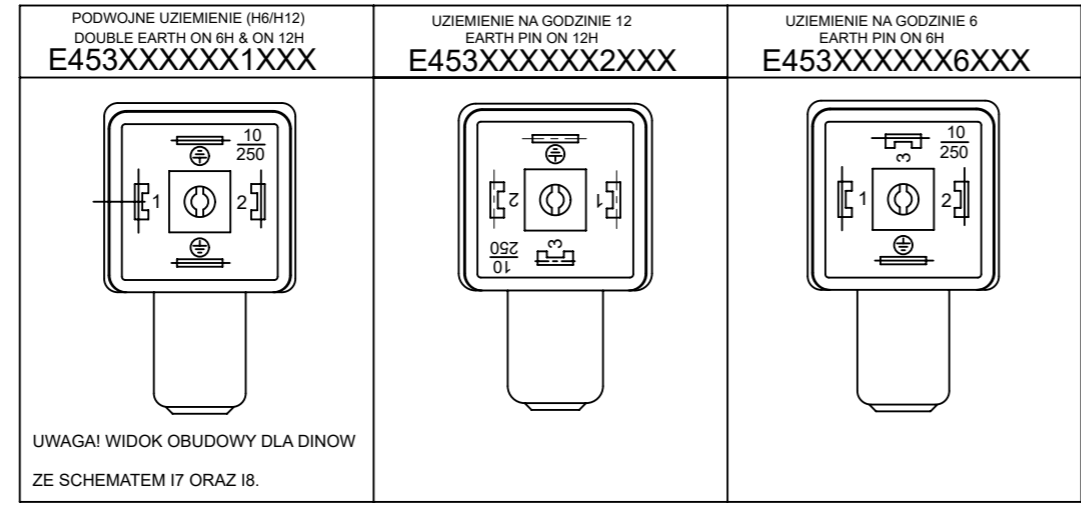

UWAGA! WIDOK OBUDOWY DLA DINOW
ZE SCHEMATEM I7 ORAZ I8.

CYNOWAC
TINNED

Table of length tolerances/ Tablica tolerancji dlugosci mm		
Over/Od	Up to and including/ Do-wlacznie	Tolerance/Tolerancja
100	1000	±20
1000	3000	±30
3000	5000	±40
5000	10000	±50
10000	15000	±100
15000	20000	±150
20000		±L/100

UWAGI:
1. DLUGOSC PATRZ ARKUSZ 2.

NOTES:
1. LENGHT SEE SHEET 2.

SCHEMATY POLACZEN/WIRING CONFIGURATION

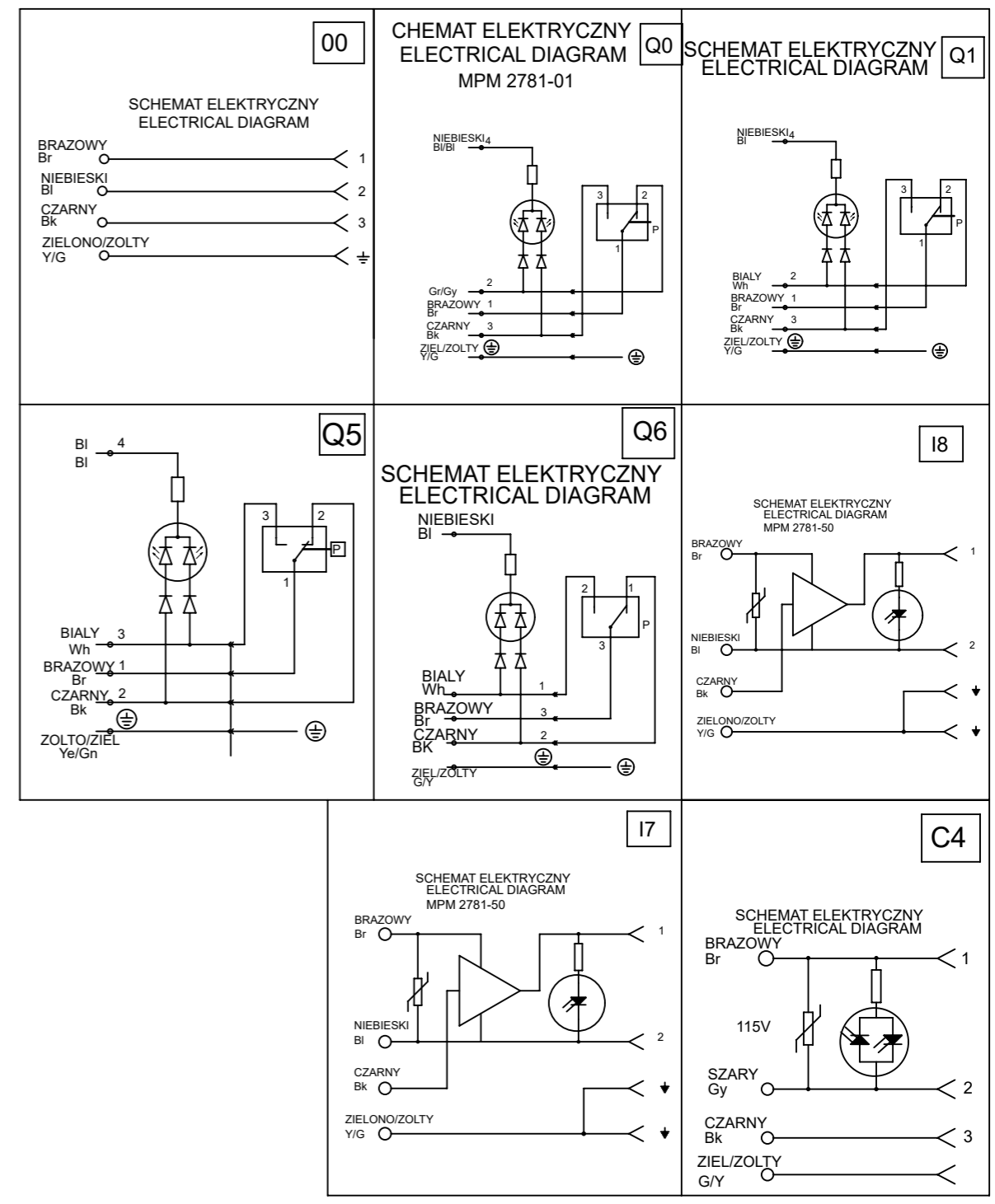

THIS DRAWING CONTAINS INFORMATION THAT IS PROPRIETARY TO MOLEX ELECTRONIC TECHNOLOGIES, LLC AND SHOULD NOT BE USED WITHOUT WRITTEN PERMISSION											
DIMENSION UNITS mm		SCALE NTS		CURRENT REV DESC: REMOVED OBSOLETE PART NUMBER AS PER PCN#510806.				molex		MPM E453XXXXXXXXXX	
GENERAL TOLERANCES (UNLESS SPECIFIED)				EC NO: 733771 DRWN: LIKITV 2023/01/10 CHK'D: GGA 2023/02/24 APPR: GGA 2023/02/24							
4 PLACES ±		MM INCH		INITIAL REVISION:				DOCUMENT NUMBER		DOC TYPE DOC PART REVISION	
3 PLACES ±				DRWN: MWOLSZCZAK 2009/01/20				E453XXXXXXXXXX		PSD 001 B2	
2 PLACES ±				APPR: GOGRODNIK 2009/01/20				MATERIAL NUMBER		CUSTOMER	
1 PLACE ±				DRAFT WHERE APPLICABLE MUST REMAIN WITHIN DIMENSIONS				SEE TABLE		GENERAL MARKET	
0 PLACES ±		ANGULAR TOL ± °		FIRST ANGLE PROJECTION		DRAWING		SERIES		SHEET NUMBER	
				A3-SIZE		121040		1 OF 4			

E 4 5 3 X X X X X X X X X X X

E - Pakowanie bez workow
 W - Pakowanie pojedynczo
 Q - Szybkie pakowanie

ILOSC PRZEWODOW/NUMBER OF WIRES:
 1=2 PRZEWODY,
 2=2 PRZEWODY+UZIEMIENIE,
 3=3 PRZEWODY+UZIEMIENIE.

TYP KABLA/CABLE TYPE
 PATRZ TABELA 1/SEE TABLE 1

RODZAJ KABLA/CABLE CROSS SECTION AREA
 PATRZ TABELA 2/SEE TABLE 2

KOLOR MOULDINGU/HEAD COLOUR:
 G=SZARY/GREY;
 N=CZARNY/BLACK;
 T=PRZETROCZYSTY/TRANSPARENT;
 A=CZARNY/BLACK;
 B=SZARY/GREY.

DLUGOSC KABLA W CM/CABLE LENGHT IN CM
 NP:050=50 CM, 300=300 CM.

POLOZENIE PINU Z UZIEMIENIEM/EARTH PIN LOCATION:
 1=PODWOJNE UZIEMIENIE NA GODZINIE 6 ORAZ 12/DOUBLE EARTH ON 6H AND 12H,
 2=UZIEMIENIE NA GODZINIE 12/1EARTH ON 12H,
 6=UZIEMIENIE NA GODZINIE 6/EARTH ON 6H.

GASKET ORAZ SRUBY/GASKET SCREWS:
 1=GASKET PROFILOWANY+SRUBA/NBR PROFILE GASKET+FIXING SCREWS,
 2=NBR PLASKI GASKET+SRUBA/NBR FLAT GASKET+SCREW,
 3=SILIKONOWY PROFILOWANY GASKET+SRUBA/SILICONE PROFILE GASKET+SCREW,
 4=SILIKONOWY PLASKI GASKET+SRUBA/SILICON FLAT GASKET+SCREW,
 P=ZINTEGROWANY GASKET+SRUBA/INTEGRATED GASKET+FIXING SCREW,
 R=ZINTEGROWANY GASKET+SRUBA/INTEGRATED GASKET+SCREW,
 T=PROFILOWANY GASKET+SRUBA, PROFILE GASKET+SCREW.

RODZAJ POLACZENIA/INTERNAL CIRCUIT
 PATRZ SCHEMATY POLACZEN/WIRING CONFIGURATION

NAPIECIE ORAZ KOLOR DIODY/VOLTAGE AND LED COLOUR:

1= 12V	} CZERWONA DIODA RED LED	A= 12V	} ZIELONA DIODA GREEN LED	G= 12V	} ZOLTA DIODA YELLOW LED
2= 24V		B= 24V		H= 24V	
3= 48V		C= 48V		K= 48V	
4= 115V		D= 115V		L= 115V	
5= 230V		E= 230V		M= 230V	

THIS DRAWING CONTAINS INFORMATION THAT IS PROPRIETARY TO MOLEX ELECTRONIC TECHNOLOGIES, LLC AND SHOULD NOT BE USED WITHOUT WRITTEN PERMISSION											
DIMENSION UNITS mm		SCALE NTS		CURRENT REV DESC: REMOVED OBSOLETE PART NUMBER AS PER PCN#510806.				molex		MPM E453XXXXXXXXXX	
GENERAL TOLERANCES (UNLESS SPECIFIED)				EC NO: 733771		2023/01/10					
				DRWN: LIKITV		2023/02/24		PRODUCT CUSTOMER DRAWING			
				CHK'D: GGA		2023/02/24					
				APPR: GGA		2023/02/24		DOCUMENT NUMBER E453XXXXXXXXXX			
				INITIAL REVISION:							
				DRWN: MWOLSZCZAK		2009/01/20		REVISION B2			
				APPR: GOGRODNIK		2009/01/20					
DRAFT WHERE APPLICABLE MUST REMAIN WITHIN DIMENSIONS		FIRST ANGLE PROJECTION		DRAWING		SERIES		MATERIAL NUMBER		CUSTOMER	
				A3-SIZE		121040		SEE TABLE		GENERAL MARKET	
										SHEET NUMBER 2 OF 4	

DOCUMENT STATUS	P1	RELEASE DATE	2023/02/24	12:54:34
-----------------	----	--------------	------------	----------

TABELA 2 KABLE/TABLE 2 CABLES

MOLEX PN	mPm	Code	PRZEW	PRZEKROJ	MATERIAL	KOLOR/COLOUR	SREDNICA Ø	DIN A-B	DIN C
1210180080	I	0	3	1 mm2	PVC CEI 2022 II O.R.	Szary/Grey RAL7035	-	-	-
1210180467	A	2	2	20 AWG	PVC CSA/UL 2661	Czarny/Black	5,5+/-0,2 mm	OK.	OK.
-	A	2	3	20 AWG	PVC CSA/UL 2661	Czarny/Black	5,6+/-0,2 mm	OK.	OK.
1210180394	A	2	4	20 AWG	PVC CSA/UL 2661	Czarny/Black	6,2+/-0,2 mm	OK.	OK.
-	A	2	5	20 AWG	PVC CSA/UL 2661	Czarny/Black	7+/-0,2 mm	OK.	
1210180297	B	2	2	20 AWG	PUR CSA/UL 20668	Czarny/Black	5,5+/-0,2 mm	OK.	OK.
1210180126	B	2	3	20 AWG	PUR CSA/UL 20668	Czarny/Black	5,6+/-0,2 mm	OK.	OK.
1210180387	B	2	4	20 AWG	PUR CSA/UL 20668	Czarny/Black	6,2+/-0,2 mm	OK.	OK.
-	B	2	5	20 AWG	PUR CSA/UL 20668	Czarny/Black	7+/-0,2 mm	OK.	
1210180122	D	2	3	0,5 mm2	PVC TI2 CEI 20-20	Szary/Grey	-	-	-
-	F	2	3	0,5 mm2	CNOMO	Szary/Grey RAL7000	5,5+/-0,2 mm	OK.	OK.
1210180047	I	2	2	0,5 mm2	PVC CEI 2022 II O.R.	Szary/Grey RAL7035	5,5+/-0,2 mm	OK.	OK.
-	I	2	3	0,5 mm2	PVC CEI 2022 II O.R.	Szary/Grey RAL7035	5,5+/-0,2 mm	OK.	OK.
1210180146	I	2	4	0,5 mm2	PVC CEI 2022 II O.R.	Szary/Grey RAL7035	6,5+/-0,2 mm	OK.	
1210180177	I	2	5	0,5 mm2	PVC CEI 2022 II O.R.	Szary/Grey RAL7035	7+/-0,2 mm	OK.	
1210180022	N	2	2	0,5 mm2	PVCH03	Czarny/Black	5,1+ 0,2-0 mm	OK.	OK.
1210180064	N	2	3	0,5 mm2	PVCH03	Czarny/Black	5,4+ 0,2-0 mm	OK.	OK.
1210180153	N	2	4	0,5 mm2	PVCH03	Czarny/Black	5,75+0,2-0 mm	OK.	OK.
1210180046	P	2	2	0,5 mm2	PUR - BLEND	Czarny/Black	5,5+/-0,2 mm	OK.	OK.
-	P	2	3	0,5 mm2	PUR - BLEND	Czarny/Black	5,5+/-0,2 mm	OK.	OK.
1210180302	P	2	4	0,5 mm2	PUR - BLEND	Czarny/Black	-	-	-
-	P	2	5	0,5 mm2	PUR - BLEND	Czarny/Black	7+/-0,2 mm	OK.	OK.
1210180409	A	3	2	18 AWG	PVC CSA/UL 2661	Czarny/Black	6,5+/-0,2 mm	OK.	
1210180129	A	3	3	18 AWG	PVC CSA/UL 2661	Czarny/Black	6,5+/-0,2 mm	OK.	
1210180159	A	3	4	18 AWG	PVC CSA/UL 2661	Czarny/Black	7+/-0,2 mm	OK.	
-	A	3	5	18 AWG	PVC CSA/UL 2661	Czarny/Black	7,8+/-0,2 mm	OK.	
1210180351	B	3	2	18 AWG	PUR CSA/UL 20668	Czarny/Black	6,5+/-0,2 mm	OK.	
1210180127	B	3	3	18 AWG	PUR CSA/UL 20668	Czarny/Black	6,5+/-0,2 mm	OK.	
1210180127	B	3	4	18 AWG	PUR CSA/UL 20668	Czarny/Black	7+/-0,2 mm	OK.	
-	B	3	5	18 AWG	PUR CSA/UL 20668	Czarny/Black	7,8+/-0,2 mm	OK.	
1210180073	D	3	3	0,75 mm2	PVC TI2 CEI 20-20	Szary/Grey	-	-	-
1210180145	D	3	4	0,75 mm2	PVC TI2 CEI 20-20	Szary/Grey	-	-	-
1210180120	I	3	3	0,75 mm2	PVC CEI 2022 II O.R.	Szary/Grey RAL7035	-	-	-
1210180143	I	3	4	0,75 mm2	PVC CEI 2022 II O.R.	Szary/Grey RAL7035	-	-	-
1210180032	N	3	2	0,75 mm2	PVCH05	Czarny/Black	6,2+ 0,2-0 mm	OK.	
1210180069	N	3	3	0,75 mm2	PVCH05	Czarny/Black	6,6+0,2-0 mm	OK.	
-	N	3	4	0,75 mm2	PVCH05	Czarny/Black	7,15+0,2-0 mm	OK.	
1210180174	N	3	5	0,75 mm2	PVCH05	Czarny/Black	8,0+0,2-0 mm	OK.	
-	P	3	2	0,75 mm2	PUR - BLEND	Czarny/Black	6,5+/-0,2 mm	OK.	

TABELA 2 KABLE/TABLE 2 CABLES

MOLEX PN	mPm	Code	PRZEW	PRZEKROJ	MATERIAL	KOLOR/COLOUR	SREDNICA Ø	DIN A-B	DIN C
1210180071	P	3	3	0,75 mm2	PUR - BLEND	Czarny/Black	6,5+/-0,2 mm	OK.	
1210180152	P	3	4	0,75 mm2	PUR - BLEND	Czarny/Black	7+/-0,2 mm	OK.	
1210180384	R	3	3	0,75 mm2	TPR HAL. FREE	Czarny/Black	6,5+/-0,2 mm	OK.	
1210180094	T	3	3	0,75 mm2	PUR CSA/UL	Żółty/Yellow	-	-	-
1210180309	Y	3	3	0,75 mm2	SIL/0300	Czerwony/Red	6,5+/-0,2 mm	-	-
1210180081	F	4	3	1 mm2	CNOMO	Szary/Grey RAL7000	-	-	-
-	F	4	4	1 mm2	CNOMO	Szary/Grey RAL7000	7,1+0,2-0 mm	OK.	
1210180042	I	4	2	1 mm2	PVC CEI 2022 II O.R.	Szary/Grey RAL7035	7,1+0,2-0 mm	OK.	
1210180079	I	4	3	1 mm2	PVC CEI 2022 II O.R.	Szary/Grey RAL7035	7,1+0,2-0 mm	OK.	
1210180036	N	4	2	1 mm2	PVCH05	Czarny/Black	6,5+0,2-0 mm	OK.	
1210180082	N	4	3	1 mm2	PVCH05	Czarny/Black	6,9+0,2-0 mm	OK.	
1210180117	R	4	3	1 mm2	TPR HAL. FREE	Czarny/Black	-	-	-
1210180085	N	5	3	1,5 mm2	PVCH05	Czarny/Black	8,3+0,2-0 mm	OK.	
1210180313	I	6	2	0,35 mm2	PVC CEI 2022 II O.R.	Szary/Grey RAL7035	-	-	-
-	A	7	3	20 AWG	PVC CSA/UL 2661	Żółty/Yellow	5,6+/-0,2 mm	OK.	OK.
1210180149	I	9	4	0,75 mm2	PVC CEI 2022 II O.R.	Szary/Grey RAL7035	-	-	-

TABELA 1 TYPY KABLI/TABLE 1 CABLES TYPE

Znakowanie /Code	Rodzaje kabla /Cable type	Właściwości / Features	Przekroje /stranding
N	PVC	Kabel z dobrą rezystancją w wodzie ale słabą w oleju./Application general purpose cable which has good resistance to water, but usually poor oil resistance.	0.5 mm2 = 15 x 0.20 0.75 mm2 = 21 x 0.20 1 mm2 = 28 x 0.20
I	PVC	Zatwierdzone przez IEC 332-2A, samogaszący./Approved to IEC 332-2A, flame retardant and self extinguishing. Limited resistant to mineral oils.	0.5 mm2 = 28 x 0.15 0.75 mm2 = 42 x 0.15 1 mm2 = 32 x 0.20
P	PVC	Dobra rezystancja w olejach i chemikaljach./Offer good resistance to oil and chemicals. Can swell when constantly immersed in water.	0.5 mm2 = 28 x 0.15 0.75 mm2 = 42 x 0.15 1 mm2 = 32 x 0.20
A	PVC	Zatwierdzony porzez CSA-UL 2661.Dobra rezystancja na wode słaba na olej./ Approved to CSA-UL 2661, application general purpose cable which has good resistance to water, but usually poor oil resistance.	20 AWG = 32 x 0.15 18 AWG = 52 x 0.15
B	PVC	Zatwierdzony przez CSA-UL 20668, bardzo dobra rezystancja w oleju i chemikaljach./ Approved to CSA-UL 20668, very good resistance to oil and chemicals.	20 AWG = 32 x 0.15 18 AWG = 52 x 0.15

THIS DRAWING CONTAINS INFORMATION THAT IS PROPRIETARY TO MOLEX ELECTRONIC TECHNOLOGIES, LLC AND SHOULD NOT BE USED WITHOUT WRITTEN PERMISSION									
DIMENSION UNITS		SCALE		CURRENT REV DESC: REMOVED OBSOLETE PART NUMBER AS PER PCN#510806.					
mm		NTS							
GENERAL TOLERANCES (UNLESS SPECIFIED)				EC NO: 733771		2023/01/10		MPM E453XXXXXXXXXX	
				DRWN: LIKITV		2023/02/24			
				CHK'D: GGA		2023/02/24			
				APPR: GGA		2023/02/24			
				INITIAL REVISION:				PRODUCT CUSTOMER DRAWING	
				DRWN: MWOLSZCZAK		2009/01/20			
				APPR: GOGRODNIK		2009/01/20			
				DOCUMENT NUMBER		E453XXXXXXXXXX		DOC TYPE DOC PART REVISION	
				ANGULAR TOL ± °				PSD 001 B2	
DRAFT WHERE APPLICABLE MUST REMAIN WITHIN DIMENSIONS				FIRST ANGLE PROJECTION		DRAWING		SHEET NUMBER	
						A3-SIZE		3 OF 4	
				SERIES		121040			
				MATERIAL NUMBER		SEE TABLE		CUSTOMER	
						GENERAL MARKET			

TABELA 3/CHART 3

MOLEX P/N	WOODHEAD P/N
1210400525	E453B3A10K22000
1210400526	E453B3A10K62000
1210400527	E453B3A30022000
1210400528	E453B3A30062000
1210400529	E453B3A50022000
1210400530	E453B3A50062000
1210400539	E453N3N30022000
1210400540	E453N3N30062000
1210400541	E453N3N50022000
1210400547	E453P3N30022000
1210400550	E453P3N50022000
1210400698	E453A3A10K62000
1210400796	E453N3N20062000
1210400833	E453A3A10022000
1210400864	E453B2A30022000
1210400937	E453N3N2002P000
1210400953	E453N3N1002P000
1210400967	E453N3N5002P000
1210400973	E453P3N2502P000
1210400980	E453A3A15K62000
1210500845	E453I3N30021Q62
1210500889	E453P2N30021Q02
1210501823	E453P2N50061Q12
1210501868	E453P2N30021Q52
1210502033	E453P3N40011I8H
1210502410	E453I2N30021Q12
1210502440	E453I2N50021Q12

MOLEX P/N	WOODHEAD P/N
1210502454	E453B3A50021Q02
1210502455	E453B3A30021Q02
1210502517	E453I2N10K21Q12
1210502557	E453I2N50021Q02
1210502562	E453N3N30022C44
1210501787	E453N3N30061Q02
1210502887	W453P2G5006RQ02
1210501869	E453P2N50021Q52
1210503035	E453N2N20061C42

THIS DRAWING CONTAINS INFORMATION THAT IS PROPRIETARY TO MOLEX ELECTRONIC TECHNOLOGIES, LLC AND SHOULD NOT BE USED WITHOUT WRITTEN PERMISSION									
DIMENSION UNITS mm		SCALE NTS		CURRENT REV DESC: REMOVED OBSOLETE PART NUMBER AS PER PCN#510806.				molex	
GENERAL TOLERANCES (UNLESS SPECIFIED)				EC NO: 733771		MPM E453XXXXXXXXXX			
				DRWN: LIKITV		2023/01/10			
				CHK'D: GGA		2023/02/24			
				APPR: GGA		2023/02/24		PRODUCT CUSTOMER DRAWING	
				INITIAL REVISION:				DOCUMENT NUMBER	
				DRWN: MWOLSZCZAK				E453XXXXXXXXXX	
				APPR: GOGRODNIK				PSD 001 B2	
				2009/01/20		2009/01/20			
DRAFT WHERE APPLICABLE MUST REMAIN WITHIN DIMENSIONS		FIRST ANGLE PROJECTION		DRAWING		SERIES		MATERIAL NUMBER	
				A3-SIZE		121040		SEE TABLE	
				CUSTOMER		GENERAL MARKET		SHEET NUMBER	
								4 OF 4	

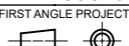
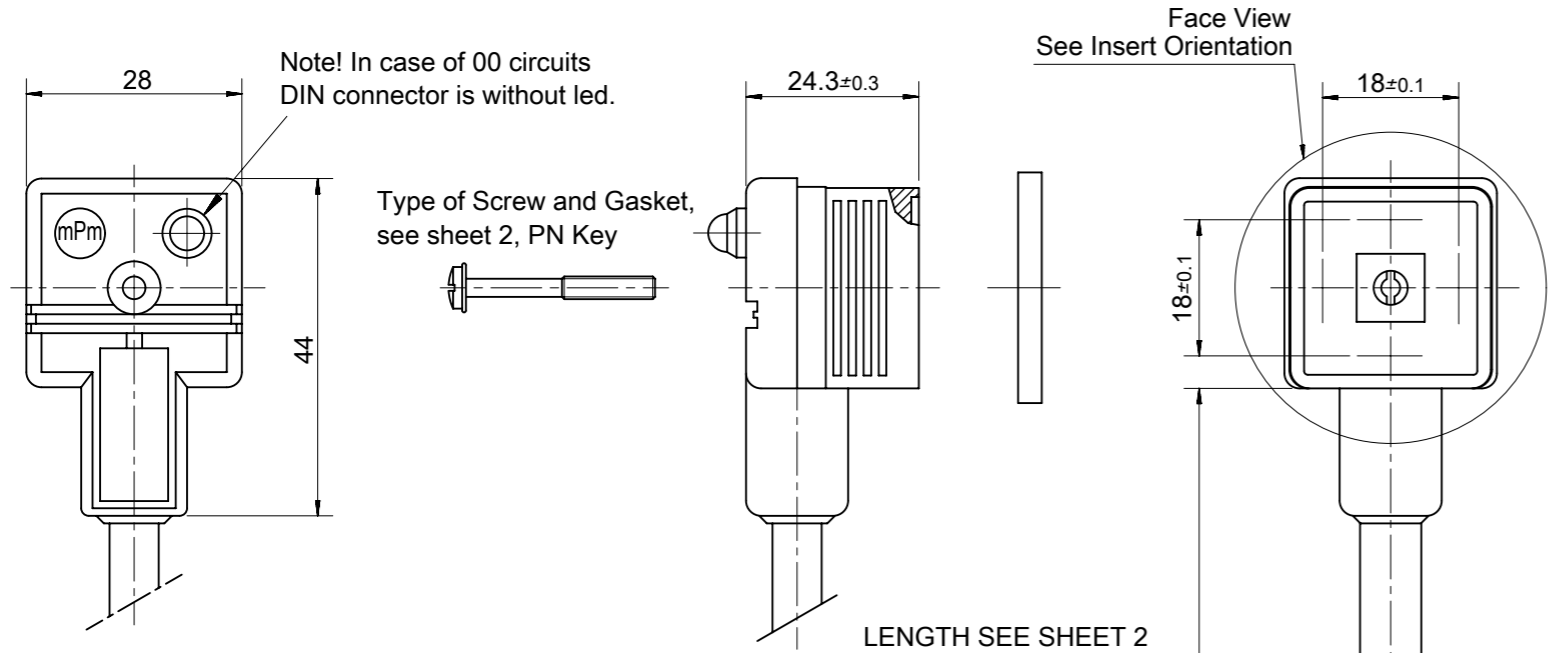

INSERT ORIENTATION

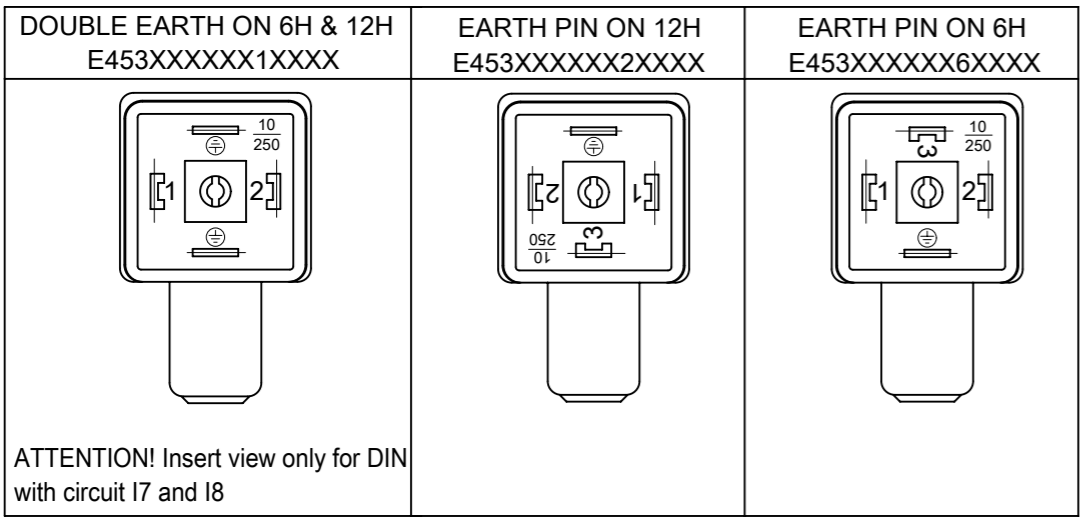
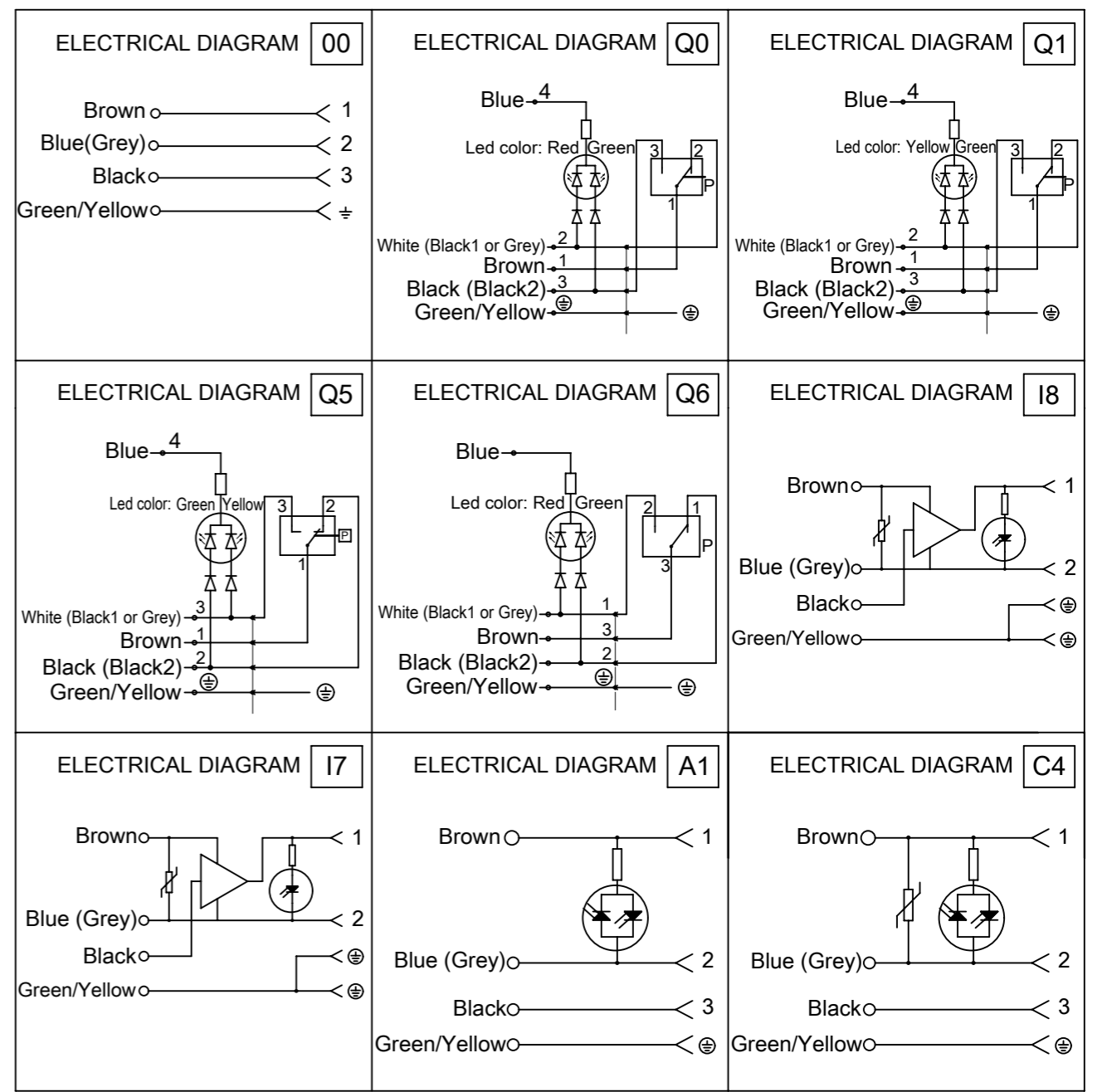

Table of length tolerances [mm]		
Over	Up to and including	Tolerance (+)
0	1000	±20
1000	3000	±30
3000	5000	±40
5000	10000	±50
10000	15000	±100
15000	20000	±150
20000		±L/100

WIRING CONFIGURATION



THIS DRAWING CONTAINS INFORMATION THAT IS PROPRIETARY TO MOLEX ELECTRONIC TECHNOLOGIES, LLC AND SHOULD NOT BE USED WITHOUT WRITTEN PERMISSION

DIMENSION UNITS	SCALE	CURRENT REV DESC: OBSOLETE PART NUMBERS	
mm	NTS		
GENERAL TOLERANCES (UNLESS SPECIFIED)			
	MM	INCH	
4 PLACES	±	±	
3 PLACES	±	±	
2 PLACES	±	±	
1 PLACE	±	±	
0 PLACES	±	±	
ANGULAR TOL	± °		
DRAFT WHERE APPLICABLE MUST REMAIN WITHIN DIMENSIONS	THIRD ANGLE PROJECTION	DRAWING	SHEET NUMBER
		A3-SIZE	121050

EC NO: 638770	2020/03/05		E453XXXXXXXXXX DIN FORM A EN 175301-803
DRWN: RPRABHUM	2020/07/21		
CHK'D: GGA	2020/07/21		
APPR: GGA	2020/07/21	PRODUCT CUSTOMER DRAWING	
INITIAL REVISION:		DOCUMENT NUMBER	DOC TYPE
DRWN: JMARSZALEK	2012/11/27	SD-121050-006	PSD
APPR: MIWASIECZKO	2014/01/30	DOC PART	REVISION
		001	D
MATERIAL NUMBER	CUSTOMER	SHEET NUMBER	
SEE SHEET 2 & 4	GENERAL MARKET	1 OF 10	

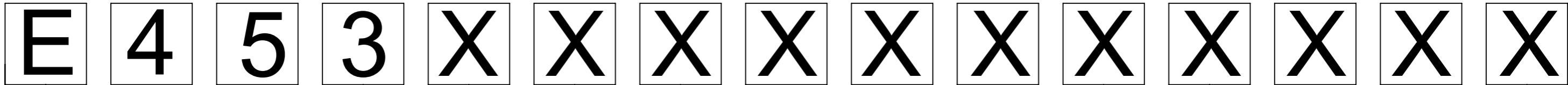

E - Packing without bags
 W - Single packing
 Q - Quick packing

NUMBER OF WIRES:
 3=3 WIRES + EARTH
 OR
 3=4 WIRES + EARTH (FOR Q CIRCUIT)

CABLE TYPE
 SEE SHEET 3 - TABLE 1

CABLE CROSS SECTION AREA
 SEE SHEET 3 - TABLE 2

HEAD COLOUR:

N=BLACK;
 A=CSA-UL BLACK;
 B=CSA-UL GREY.

CABLE LENGTH IN CM
 Eg.:050=50 CM, 300=300 CM, 10K=1000 CM.

EARTH PIN LOCATION (SEE INSERT ORIENTATION TABLE):

1=DOUBLE EARTH ON 6H AND 12H,
 2=EARTH ON 12H,
 6=EARTH ON 6H.

TYPE OF GASKET AND SCREW:

1=NBR PROFILE GASKET + FIXING SCREWS (M3x25 mm)
 2=NBR FLAT GASKET + FIXING SCREW (M3x25 mm)
 3=SILICONE PROFILE GASKET + FIXING SCREW (M3x25 mm)
 4=SILICON FLAT GASKET + FIXING SCREW (M3x25 mm)
 P=INTEGRATED GASKET ASSEMBLED + FIXING SCREW WITH WASHER ASSEMBLED (M3x27 mm)
 R=INTAGRATED GASKET + FIXING SCREW + WASHER (M3x27 mm)
 T=PROFILE GASKET + FIXING SCREW + WASHER (M3x27 mm)

INTERNAL CIRCUIT, WIRING CONFIGURATION

VOLTAGE AND LED COLOUR:

NOTE: FOR CIRCUIT TYPE Q - BICOLOR LED - ONLY 1,2,3,4,5

1= 12V	} RED LED	A= 12V	} GREEN LED	G= 12V	} YELLOW LED
2= 24V		B= 24V		H= 24V	
3= 48V		C= 48V		K= 48V	
4= 115V		D= 115V		L= 115V	
5= 230V		E= 230V		M= 230V	

THIS DRAWING CONTAINS INFORMATION THAT IS PROPRIETARY TO MOLEX ELECTRONIC TECHNOLOGIES, LLC AND SHOULD NOT BE USED WITHOUT WRITTEN PERMISSION											
DIMENSION UNITS		SCALE		CURRENT REV DESC: OBSOLETE PART NUMBERS						molex	
mm		NTS									
GENERAL TOLERANCES (UNLESS SPECIFIED)				EC NO: 638770		DRWN: RPRABHUM		2020/03/05		E453XXXXXXXXXX	
				CHK'D: GGA		2020/07/21		DIN FORM A EN 175301-803			
				APPR: GGA		2020/07/21		PRODUCT CUSTOMER DRAWING			
				INITIAL REVISION:		DRWN: JMARSZALEK		2012/11/27		DOCUMENT NUMBER	
				APPR: MIWASIECZKO		2014/01/30		SD-121050-006		DOC TYPE DOC PART REVISION	
				DRAFT WHERE APPLICABLE MUST REMAIN WITHIN DIMENSIONS		THIRD ANGLE PROJECTION		DRAWING		SHEET NUMBER	
						A3-SIZE		121050		2 OF 10	
						SERIES		MATERIAL NUMBER		CUSTOMER	
								SEE SHEET 2 & 4		GENERAL MARKET	

TABLE 2 - CABLES

Cable type	Cable code	Wires no.	Cross Section	Jacket material	Jacket color	Diameter Ø[mm]	Wire colors
I	0	3	1 mm ²	PVC CEI 2022 II O.R.	Grey	7.6±0.2	BN, BU, GN/YE
A	2	2	20 AWG	PVC CSA/UL 2661	Black	5.4±0.2	BN, BU
A	2	3	20 AWG	PVC CSA/UL 2661	Black	5.6±0.2	BN, BU, GN/YE
A	2	4	20 AWG	PVC CSA/UL 2661	Black	6.2±0.25	BN, BU, BK, GN/YE
B	2	2	20 AWG	PUR CSA/UL 20668	Black	5.6±0.2	BN, BU
B	2	3	20 AWG	PUR CSA/UL 20668	Black	5.6±0.2	BN, BU, GN/YE
B	2	4	0.5 mm ²	PUR CSA/UL 20668	Black	6.3±0.2	BN, BU, BK, GN/YE
D	2	3	0.5 mm ²	PVC CEI 20-20	Grey	5.5+0.3/-0	BN, BU, GN/YE
I	2	2	0.5 mm ²	PVC CEI 2022 II O.R.	Grey	5.5+0.3/-0	BN, BU
I	2	3	0.5 mm ²	PVC CEI 2022 II O.R.	Grey	5.5+0.3/-0	BN, BU, GN/YE
I	2	4	0.5 mm ²	PVC CEI 2022 II O.R.	Grey	6.5±0.2	BN, BU, BK, GN/YE
I	2	5	0.5 mm ²	PVC CEI 2022 II O.R.	Grey	7.0+0.3/-0	BN, BU, BK, WH, GN/YE
N	2	2	0.5 mm ²	PVC H03VV-F	Black	5.2±0.2	BN, BU
N	2	3	0.5 mm ²	PVC H03VV-F	Black	5.5±0.2	BN, BU, GN/YE
N	2	4	0.5 mm ²	PVC H03VV-F	Black	5.9±0.3	BN, BU, BK, GN/YE
P	2	2	0.5 mm ²	PUR - BLEND	Black	5.5±0.2	BN, BU
P	2	3	0.5 mm ²	PUR - BLEND	Black	5.5+0.3/-0	BN, BU, GN/YE
P	2	4	0.5 mm ²	PUR - BLEND	Black	6.5±0.2	BN, BU, BK, GN/YE
P	2	5	0.5 mm ²	PUR - BLEND	Black	7+0.3/-0.1	BN, BU, BK, WH, GN/YE
A	3	2	18 AWG	PVC CSA/UL 2661	Black	6.2±0.25	BN, BU
A	3	3	18 AWG	PVC CSA/UL 2661	Black	6.5±0.25	BN, BU, GN/YE
A	3	4	18 AWG	PVC CSA/UL 2661	Black	7.0+0.3/-0	BN, BU, BK, GN/YE
A	3	5	18 AWG	PVC CSA/UL 2661	Black	7.8±0.25	BN, BU, BK, WH, GN/YE
B	3	2	18 AWG	PUR CSA/UL 20668	Black	6.2±0.2	BN, BU
B	3	3	18 AWG	PUR CSA/UL 20668	Black	6.5±0.2	BN, BU, GN/YE
B	3	4	18 AWG	PUR CSA/UL 20668	Black	7±0.2	BN, BU, BK, GN/YE
B	3	5	18 AWG	PUR CSA/UL 20668	Black	7.8±0.25	BN, BU, BK, WH, GN/YE
D	3	3	0.75 mm ²	PVC CEI 20-20	Grey	6.5±0.2	BN, BU, GN/YE
D	3	4	0.75 mm ²	PVC CEI 20-20	Grey	7.1±0.2	BN, BU, BK, GN/YE
I	3	2	0.75 mm ²	PVC CEI 2022 II O.R.	Grey	5.5±0.2	BK1, BK2
I	3	3	0.75 mm ²	PVC CEI 2022 II O.R.	Grey	6.0±0.2	BK1, BK2, BK3
I	3	4	0.75 mm ²	PVC CEI 2022 II O.R.	Grey	7.0±0.2	BN, BU, BK, GN/YE
N	3	2	0.75 mm ²	PVC H05VV-F	Black	6.2±0.2	BN, BU
N	3	3	0.75 mm ²	PVC H05VV-F	Black	6.5±0.2	BN, BU, GN/YE
N	3	4	0.75 mm ²	PVC H05VV-F	Black	7.1±0.2	BN, BU, BK, GN/YE
N	3	5	0.75 mm ²	PVC H05VV-F	Black	8.0+0.2/-0	BN, BU, BK, GY, GN/YE
P	3	2	0.75 mm ²	PUR - BLEND	Black	6.5±0.2	BN, BU
P	3	3	0.75 mm ²	PUR - BLEND	Black	6.5±0.2	BN, BU, GN/YE
P	3	4	0.75 mm ²	PUR - BLEND	Black	7.0±0.2	BN, BU, BK, GN/YE

TABLE 2 - CABLES

Cable type	Cable code	Wires no.	Cross Section	Jacket material	Jacket color	Diameter Ø[mm]	Wire colors
R	3	3	0.75 mm ²	TPR HAL. FREE	Black	6.5±0.2	BN, BU, GN/YE
T	3	3	0.75 mm ²	PUR CSA/UL 20668	Yellow	6.5±0.2	BN, BU, GN/YE
Y	3	3	0.75 mm ²	SILICONE RUBBER	Red	6.5±0.2	BN, BU, GN/YE
F	4	3	1 mm ²	PVC CNOMO	Grey	7.1+0.2/-0	BK1, BK2, GN/YE
I	4	2	1 mm ²	PVC CEI 2022 II O.R.	Grey	7.1+0.2/-0	BN, BU
I	4	3	1 mm ²	PVC CEI 2022 II O.R.	Grey	7.1+0.2/-0	BN, BU, GN/YE
N	4	2	1 mm ²	PVC H05VV-F	Black	6.5±0.2	BN, BU
N	4	3	1 mm ²	PVC H05VV-F	Black	6.9±0.2	BN, BU, GN/YE
R	4	3	1 mm ²	TPR HAL.FREE	Black	7.1±0.2	BN, BU, GN/YE
N	5	3	1.5 mm ²	PVC H05VV-F	Black	7.9±0.2	BN, BU, GN/YE
I	6	2	0.35 mm ²	PVC CEI 2011	Grey	4.8±0.2	BN, WH
I	9	4	0.75 mm ²	PVC CEI 2022 II	Grey	7.3±0.2	BN, BU, BK, GN/YE

TABLE 1 - CABLES TYPE

Code	Cable types	Features	Cable type Cross section
N	PVC	Application general purpose cable which has good resistance to water, but usually poor oil resistance.	N2=0.5 mm ² N3=0.75 mm ² N4=1 mm ²
I	CEI	Approved to IEC 332-2A, flame retardant and self extinguishing. Limited resistant to mineral oils.	I2=0.5 mm ² I3=0.75 mm ² I4=1 mm ²
P	PUR	Offer good resistance to oil and chemicals. Can swell when constantly immersed in water.	P2=0.5 mm ² P3=0.75 mm ² P4=1 mm ²
A	PVC CSA-UL	Approved to CSA-UL 2661, application general purpose cable which has good resistance to water, but usually poor oil resistance.	A2=20 AWG A3=18 AWG
B	PUR CSA-UL	Approved to CSA-UL 20668, very good resistance to oil and chemicals.	B2=20 AWG B3=18 AWG

THIS DRAWING CONTAINS INFORMATION THAT IS PROPRIETARY TO MOLEX ELECTRONIC TECHNOLOGIES, LLC AND SHOULD NOT BE USED WITHOUT WRITTEN PERMISSION		CURRENT REV DESC: OBSOLETE PART NUMBERS		 E453XXXXXXXXXX DIN FORM A EN 175301-803	
DIMENSION UNITS	SCALE	EC NO: 638770			
mm	NTS	DRWN: RPRABHUM 2020/03/05		PRODUCT CUSTOMER DRAWING	
GENERAL TOLERANCES (UNLESS SPECIFIED)		CHK'D: GGA 2020/07/21			
		APPR: GGA 2020/07/21		DOCUMENT NUMBER	
4 PLACES ±		INITIAL REVISION:		SD-121050-006	
3 PLACES ±		DRWN: JMARSZALEK 2012/11/27		DOC TYPE DOC PART REVISION	
2 PLACES ±		APPR: MIWASIECZKO 2014/01/30		PSD 001 D	
1 PLACE ±		DRAFT WHERE APPLICABLE MUST REMAIN WITHIN DIMENSIONS		SHEET NUMBER	
0 PLACES ±		THIRD ANGLE PROJECTION		3 OF 10	
ANGULAR TOL ± °		DRAWING		MATERIAL NUMBER	
		A3-SIZE		SEE SHEET 2 & 4	
		SERIES		CUSTOMER	
		121050		GENERAL MARKET	

TABLE 3 - PART LIST

1	1210400521	E453A3A30022000	41	1210401307	W453P3N50062000	81	1210502979	E453P2N10K2PQ02	121	2210507761	E453A2A10K21175	161	2210507801	E453A2A2002117K
2	1210400522	E453A3A30062000	42	1210500839 VO	E453I3N20021Q02	82	1210502980	E453P2N50K2RQ02	122	2210507762	E453A2A10K2117A	162	2210507802	E453A2A2002117L
3	1210400524 VO	E453B3A10062000	43	1210500842	E453I3N30021Q02	83	1210503016	E453B3A30063Q02	123	2210507763	E453A2A10K2117B	163	2210507803	E453A2A2002117M
4	1210400525	E453B3A10K22000	44	1210500844	E453I3N30021Q12	84	1210503019	E453N3N30021A1H	124	2210507764	E453A2A10K2117C	164	2210507804	E453A2A30011000
5	1210400526	E453B3A10K62000	45	1210500845	E453I3N30021Q62	85	1210503035	E453N2N20061C42	125	2210507765	E453A2A10K2117D	165	2210507805	E453A2A30021171
6	1210400527	E453B3A30022000	46	1210500848	E453I3N30061Q12	86	1210503043	E453P3N3001PI7H	126	2210507766	E453A2A10K2117E	166	2210507806	E453A2A30021172
7	1210400528	E453B3A30062000	47	1210500854	E453I3N50021Q12	87	1210503107	E453A3A15021Q02	127	2210507767	E453A2A10K2117G	167	2210507807	E453A2A30021173
8	1210400529	E453B3A50022000	48	1210500858	E453I3N50061Q12	88	1210503108	E453A3A30021Q02	128	2210507768	E453A2A10K2117H	168	2210507808	E453A2A30021174
9	1210400530	E453B3A50062000	49	1210500875	E453N3N50022Q02	89	1210503109	E453A3A50021Q02	129	2210507769	E453A2A10K2117K	169	2210507809	E453A2A30021175
10	1210400537	E453N3N10022000	50	1210500888	E453P2N30021Q01	90	1210503110	E453A3A75021Q02	130	2210507770	E453A2A10K2117L	170	2210507810	E453A2A3002117A
11	1210400538	E453N3N10062000	51	1210500889	E453P2N30021Q02	91	1210503111	E453A3A10K21Q02	131	2210507771	E453A2A10K2117M	171	2210507811	E453A2A3002117B
12	1210400539	E453N3N30022000	52	1210500895	E453P2N30061Q12	92	1210503124	E453I2N50021Q62	132	2210507772	E453A2A15011000	172	2210507812	E453A2A3002117C
13	1210400540	E453N3N30062000	53	1210501705	E453N3N30021Q02	93	1210503134	E453N3N05021Q12	133	2210507773	E453A2A15021171	173	2210507813	E453A2A3002117D
14	1210400541	E453N3N50022000	54	1210501787	E453N3N30061Q02	94	1210503230	E453N3N40061C42	134	2210507774	E453A2A15021172	174	2210507814	E453A2A3002117E
15	1210400542	E453N3N50062000	55	1210501794	E453I3N10K61Q02	95	1210503249	E453P2N50021Q02	135	2210507775	E453A2A15021173	175	2210507815	E453A2A3002117G
16	1210400544	E453P3N10022000	56	1210501823	E453P2N50061Q12	96	1210503251	E453N3N10K2RC4B	136	2210507776	E453A2A15021174	176	2210507816	E453A2A3002117H
17	1210400545	E453P3N10062000	57	1210501848	E453P3N4001117H	97	1210503252	E453N3N10K2RC4A	137	2210507777	E453A2A15021175	177	2210507817	E453A2A3002117K
18	1210400547	E453P3N30022000	58	1210501868	E453P2N30021Q52	98	1210503430	E453I2N15K61Q12	138	2210507778	E453A2A1502117A	178	2210507818	E453A2A3002117L
19	1210400548	E453P3N30062000	59	1210501869	E453P2N50021Q52	99	1210503434	E453N3N25021C4H	139	2210507779	E453A2A1502117B	179	2210507819	E453A2A3002117M
20	1210400550	E453P3N50022000	60	1210502033	E453P3N4001118H	100	2210507740	E453A2A10011000	140	2210507780	E453A2A1502117C	180	2210507820	E453A2A50011000
21	1210400551	E453P3N50062000	61	1210502131	E453I2N30021Q02	101	2210507741	E453A2A10021171	141	2210507781	E453A2A1502117D	181	2210507821	E453A2A50021171
22	1210400675	E453A3A50022000	62	1210502409	E453I2N20021Q12	102	2210507742	E453A2A10021172	142	2210507782	E453A2A1502117E	182	2210507822	E453A2A50021172
23	1210400684	E453N3N10K62000	63	1210502410	E453I2N30021Q12	103	2210507743	E453A2A10021173	143	2210507783	E453A2A1502117G	183	2210507823	E453A2A50021173
24	1210400696	E453A3A10K22000	64	1210502440	E453I2N50021Q12	104	2210507744	E453A2A10021174	144	2210507784	E453A2A1502117H	184	2210507824	E453A2A50021174
25	1210400697	E453A3A50062000	65	1210502446	E453I3N80021Q12	105	2210507745	E453A2A10021175	145	2210507785	E453A2A1502117K	185	2210507825	E453A2A50021175
26	1210400698	E453A3A10K62000	66	1210502452	E453B3A50061Q02	106	2210507746	E453A2A1002117A	146	2210507786	E453A2A1502117L	186	2210507826	E453A2A5002117A
27	1210400796	E453N3N20062000	67	1210502453	E453B3A10K21Q02	107	2210507747	E453A2A1002117B	147	2210507787	E453A2A1502117M	187	2210507827	E453A2A5002117B
28	1210400833	E453A3A10022000	68	1210502454	E453B3A50021Q02	108	2210507748	E453A2A1002117C	148	2210507788	E453A2A20011000	188	2210507828	E453A2A5002117C
29	1210400864	E453B2A30022000	69	1210502455	E453B3A30021Q02	109	2210507749	E453A2A1002117D	149	2210507789	E453A2A20021171	189	2210507829	E453A2A5002117D
30	1210400937	E453N3N2002P000	70	1210502473	E453I3N5002RQ02	110	2210507750	E453A2A1002117E	150	2210507790	E453A2A20021172	190	2210507830	E453A2A5002117E
31	1210400953	E453N3N1002P000	71	1210502517	E453I2N10K21Q12	111	2210507751	E453A2A1002117G	151	2210507791	E453A2A20021173	191	2210507831	E453A2A5002117G
32	1210400967	E453N3N5002P000	72	1210502535	E453P2N10K61Q12	112	2210507752	E453A2A1002117H	152	2210507792	E453A2A20021174	192	2210507832	E453A2A5002117H
33	1210400973	E453P3N2502P000	73	1210502557	E453I2N50021Q02	113	2210507753	E453A2A1002117K	153	2210507793	E453A2A20021175	193	2210507833	E453A2A5002117K
34	1210400974	E453P3N2002P000	74	1210502562	E453N3N30022C44	114	2210507754	E453A2A1002117L	154	2210507794	E453A2A2002117A	194	2210507834	E453A2A5002117L
35	1210400980	E453A3A15K62000	75	1210502603	E453P3N5001118H	115	2210507755	E453A2A1002117M	155	2210507795	E453A2A2002117B	195	2210507835	E453A2A5002117M
36	1210401232	W453P3N30022000	76	1210502668	E453I2N30021Q62	116	2210507756	E453A2A10K11000	156	2210507796	E453A2A2002117C	196	2210507836	E453A3A10011000
37	1210401236	W453N3N30022000	77	1210502941	W453I3N5002RQ02	117	2210507757	E453A2A10K21171	157	2210507797	E453A2A2002117D	197	2210507837	E453A3A10021171
38	1210401264	E453P3N5002P000	78	1210502964	W453I3N2002RQ02	118	2210507758	E453A2A10K21172	158	2210507798	E453A2A2002117E	198	2210507838	E453A3A10021172
39	1210401266	W453N3N50022000	79	1210502966	W453A3A10K2RQ02	119	2210507759	E453A2A10K21173	159	2210507799	E453A2A2002117G	199	2210507839	E453A3A10021173
40	1210401267	W453N3N50062000	80	1210502972	E453N2N80011172	120	2210507760	E453A2A10K21174	160	2210507800	E453A2A2002117H	200	2210507840	E453A3A10021174

THIS DRAWING CONTAINS INFORMATION THAT IS PROPRIETARY TO MOLEX ELECTRONIC TECHNOLOGIES, LLC AND SHOULD NOT BE USED WITHOUT WRITTEN PERMISSION				
DIMENSION UNITS: mm		SCALE: NTS		
CURRENT REV DESC: OBSOLETE PART NUMBERS				
GENERAL TOLERANCES (UNLESS SPECIFIED)		molex		
		E453XXXXXXXXXX DIN FORM A EN 175301-803		
		PRODUCT CUSTOMER DRAWING		
4 PLACES ±		EC NO: 638770		
3 PLACES ±		DRWN: RPRABHUM 2020/03/05		
2 PLACES ±		CHK'D: GGA 2020/07/21		
1 PLACE ±		APPR: GGA 2020/07/21		
0 PLACES ±		INITIAL REVISION:		
ANGULAR TOL ± °		DRWN: JMARSZALEK 2012/11/27		
DRAFT WHERE APPLICABLE MUST REMAIN WITHIN DIMENSIONS		APPR: MIWASIECZKO 2014/01/30		
THIRD ANGLE PROJECTION		DRAWING	SERIES	MATERIAL NUMBER
		A3-SIZE	121050	SEE SHEET 2 & 4
CUSTOMER		SHEET NUMBER		
GENERAL MARKET		4 OF 10		

TABLE 3 - PART LIST

Pos.	Molex PN:	Engineering No.:
201	2210507841	E453A3A10021I75
202	2210507842	E453A3A10021I7A
203	2210507843	E453A3A10021I7B
204	2210507844	E453A3A10021I7C
205	2210507845	E453A3A10021I7D
206	2210507846	E453A3A10021I7E
207	2210507847	E453A3A10021I7G
208	2210507848	E453A3A10021I7H
209	2210507849	E453A3A10021I7K
210	2210507850	E453A3A10021I7L
211	2210507851	E453A3A10021I7M
212	2210507852	E453A3A10K11000
213	2210507853	E453A3A10K21I71
214	2210507854	E453A3A10K21I72
215	2210507855	E453A3A10K21I73
216	2210507856	E453A3A10K21I74
217	2210507857	E453A3A10K21I75
218	2210507858	E453A3A10K21I7A
219	2210507859	E453A3A10K21I7B
220	2210507860	E453A3A10K21I7C
221	2210507861	E453A3A10K21I7D
222	2210507862	E453A3A10K21I7E
223	2210507863	E453A3A10K21I7G
224	2210507864	E453A3A10K21I7H
225	2210507865	E453A3A10K21I7K
226	2210507866	E453A3A10K21I7L
227	2210507867	E453A3A10K21I7M
228	2210507868	E453A3A15011000
229	2210507869	E453A3A15021I71
230	2210507870	E453A3A15021I72
231	2210507871	E453A3A15021I73
232	2210507872	E453A3A15021I74
233	2210507873	E453A3A15021I75
234	2210507874	E453A3A15021I7A
235	2210507875	E453A3A15021I7B
236	2210507876	E453A3A15021I7C
237	2210507877	E453A3A15021I7D
238	2210507878	E453A3A15021I7E
239	2210507879	E453A3A15021I7G
240	2210507880	E453A3A15021I7H

Pos.	Molex PN:	Engineering No.:
241	2210507881	E453A3A15021I7K
242	2210507882	E453A3A15021I7L
243	2210507883	E453A3A15021I7M
244	2210507884	E453A3A20011000
245	2210507885	E453A3A20021I71
246	2210507886	E453A3A20021I72
247	2210507887	E453A3A20021I73
248	2210507888	E453A3A20021I74
249	2210507889	E453A3A20021I75
250	2210507890	E453A3A20021I7A
251	2210507891	E453A3A20021I7B
252	2210507892	E453A3A20021I7C
253	2210507893	E453A3A20021I7D
254	2210507894	E453A3A20021I7E
255	2210507895	E453A3A20021I7G
256	2210507896	E453A3A20021I7H
257	2210507897	E453A3A20021I7K
258	2210507898	E453A3A20021I7L
259	2210507899	E453A3A20021I7M
260	2210507900	E453A3A30011000
261	2210507901	E453A3A30021I71
262	2210507902	E453A3A30021I72
263	2210507903	E453A3A30021I73
264	2210507904	E453A3A30021I74
265	2210507905	E453A3A30021I75
266	2210507906	E453A3A30021I7A
267	2210507907	E453A3A30021I7B
268	2210507908	E453A3A30021I7C
269	2210507909	E453A3A30021I7D
270	2210507910	E453A3A30021I7E
271	2210507911	E453A3A30021I7G
272	2210507912	E453A3A30021I7H
273	2210507913	E453A3A30021I7K
274	2210507914	E453A3A30021I7L
275	2210507915	E453A3A30021I7M
276	2210507916	E453A3A50011000
277	2210507917	E453A3A50021I71
278	2210507918	E453A3A50021I72
279	2210507919	E453A3A50021I73
280	2210507920	E453A3A50021I74

Pos.	Molex PN:	Engineering No.:
281	2210507921	E453A3A50021I75
282	2210507922	E453A3A50021I7A
283	2210507923	E453A3A50021I7B
284	2210507924	E453A3A50021I7C
285	2210507925	E453A3A50021I7D
286	2210507926	E453A3A50021I7E
287	2210507927	E453A3A50021I7G
288	2210507928	E453A3A50021I7H
289	2210507929	E453A3A50021I7K
290	2210507930	E453A3A50021I7L
291	2210507931	E453A3A50021I7M
292	2210507932	E453B2A10011000
293	2210507933	E453B2A10021I71
294	2210507934	E453B2A10021I72
295	2210507935	E453B2A10021I73
296	2210507936	E453B2A10021I74
297	2210507937	E453B2A10021I75
298	2210507938	E453B2A10021I7A
299	2210507939	E453B2A10021I7B
300	2210507940	E453B2A10021I7C
301	2210507941	E453B2A10021I7D
302	2210507942	E453B2A10021I7E
303	2210507943	E453B2A10021I7G
304	2210507944	E453B2A10021I7H
305	2210507945	E453B2A10021I7K
306	2210507946	E453B2A10021I7L
307	2210507947	E453B2A10021I7M
308	2210507948	E453B2A10K11000
309	2210507949	E453B2A10K21I71
310	2210507950	E453B2A10K21I72
311	2210507951	E453B2A10K21I73
312	2210507952	E453B2A10K21I74
313	2210507953	E453B2A10K21I75
314	2210507954	E453B2A10K21I7A
315	2210507955	E453B2A10K21I7B
316	2210507956	E453B2A10K21I7C
317	2210507957	E453B2A10K21I7D
318	2210507958	E453B2A10K21I7E
319	2210507959	E453B2A10K21I7G
320	2210507960	E453B2A10K21I7H

Pos.	Molex PN:	Engineering No.:
321	2210507961	E453B2A10K21I7K
322	2210507962	E453B2A10K21I7L
323	2210507963	E453B2A10K21I7M
324	2210507964	E453B2A15011000
325	2210507965	E453B2A15021I71
326	2210507966	E453B2A15021I72
327	2210507967	E453B2A15021I73
328	2210507968	E453B2A15021I74
329	2210507969	E453B2A15021I75
330	2210507970	E453B2A15021I7A
331	2210507971	E453B2A15021I7B
332	2210507972	E453B2A15021I7C
333	2210507973	E453B2A15021I7D
334	2210507974	E453B2A15021I7E
335	2210507975	E453B2A15021I7G
336	2210507976	E453B2A15021I7H
337	2210507977	E453B2A15021I7K
338	2210507978	E453B2A15021I7L
339	2210507979	E453B2A15021I7M
340	2210507980	E453B2A20011000
341	2210507981	E453B2A20021I71
342	2210507982	E453B2A20021I72
343	2210507983	E453B2A20021I73
344	2210507984	E453B2A20021I74
345	2210507985	E453B2A20021I75
346	2210507986	E453B2A20021I7A
347	2210507987	E453B2A20021I7B
348	2210507988	E453B2A20021I7C
349	2210507989	E453B2A20021I7D
350	2210507990	E453B2A20021I7E
351	2210507991	E453B2A20021I7G
352	2210507992	E453B2A20021I7H
353	2210507993	E453B2A20021I7K
354	2210507994	E453B2A20021I7L
355	2210507995	E453B2A20021I7M
356	2210507996	E453B2A30011000
357	2210507997	E453B2A30021I71
358	2210507998	E453B2A30021I72
359	2210507999	E453B2A30021I73
360	2210508000	E453B2A30021I74

Pos.	Molex PN:	Engineering No.:
361	2210508001	E453B2A30021I75
362	2210508002	E453B2A30021I7A
363	2210508003	E453B2A30021I7B
364	2210508004	E453B2A30021I7C
365	2210508005	E453B2A30021I7D
366	2210508006	E453B2A30021I7E
367	2210508007	E453B2A30021I7G
368	2210508008	E453B2A30021I7H
369	2210508009	E453B2A30021I7K
370	2210508010	E453B2A30021I7L
371	2210508011	E453B2A30021I7M
372	2210508012	E453B2A50011000
373	2210508013	E453B2A50021I71
374	2210508014	E453B2A50021I72
375	2210508015	E453B2A50021I73
376	2210508016	E453B2A50021I74
377	2210508017	E453B2A50021I75
378	2210508018	E453B2A50021I7A
379	2210508019	E453B2A50021I7B
380	2210508020	E453B2A50021I7C
381	2210508021	E453B2A50021I7D
382	2210508022	E453B2A50021I7E
383	2210508023	E453B2A50021I7G
384	2210508024	E453B2A50021I7H
385	2210508025	E453B2A50021I7K
386	2210508026	E453B2A50021I7L
387	2210508027	E453B2A50021I7M
388	2210508028	E453B3A10011000
389	2210508029	E453B3A10021I71
390	2210508030	E453B3A10021I72
391	2210508031	E453B3A10021I73
392	2210508032	E453B3A10021I74
393	2210508033	E453B3A10021I75
394	2210508034	E453B3A10021I7A
395	2210508035	E453B3A10021I7B
396	2210508036	E453B3A10021I7C
397	2210508037	E453B3A10021I7D
398	2210508038	E453B3A10021I7E
399	2210508039	E453B3A10021I7G
400	2210508040	E453B3A10021I7H

THIS DRAWING CONTAINS INFORMATION THAT IS PROPRIETARY TO MOLEX ELECTRONIC TECHNOLOGIES, LLC AND SHOULD NOT BE USED WITHOUT WRITTEN PERMISSION			
DIMENSION UNITS	SCALE	CURRENT REV DESC: OBSOLETE PART NUMBERS	
mm	NTS	 E453XXXXXXXXXX DIN FORM A EN 175301-803	
GENERAL TOLERANCES (UNLESS SPECIFIED)			
	MM INCH		
4 PLACES	± ±		
3 PLACES	± ±	EC NO: 638770 DRWN: RPRABHUM 2020/03/05 CHK'D: GGA 2020/07/21 APPR: GGA 2020/07/21	
2 PLACES	± ±		
1 PLACE	± ±	INITIAL REVISION: DRWN: JMARSZALEK 2012/11/27 APPR: MIWASIECZKO 2014/01/30	
0 PLACES	± ±		
ANGULAR TOL	± °	DOCUMENT NUMBER	DOC TYPE
DRAFT WHERE APPLICABLE MUST REMAIN WITHIN DIMENSIONS		THIRD ANGLE PROJECTION	DRAWING
		SERIES	MATERIAL NUMBER
		SEE SHEET 2 & 4	CUSTOMER
		A3-SIZE	121050
		PSD	001
		REVISION	D
		SHEET NUMBER	
		5 OF 10	

TABLE 3 - PART LIST

Pos.	Molex PN:	Engineering No.:
401	2210508041	E453B3A10021I7K
402	2210508042	E453B3A10021I7L
403	2210508043	E453B3A10021I7M
404	2210508044	E453B3A10K11000
405	2210508045	E453B3A10K21I71
406	2210508046	E453B3A10K21I72
407	2210508047	E453B3A10K21I73
408	2210508048	E453B3A10K21I74
409	2210508049	E453B3A10K21I75
410	2210508050	E453B3A10K21I7A
411	2210508051	E453B3A10K21I7B
412	2210508052	E453B3A10K21I7C
413	2210508053	E453B3A10K21I7D
414	2210508054	E453B3A10K21I7E
415	2210508055	E453B3A10K21I7G
416	2210508056	E453B3A10K21I7H
417	2210508057	E453B3A10K21I7K
418	2210508058	E453B3A10K21I7L
419	2210508059	E453B3A10K21I7M
420	2210508060	E453B3A15011000
421	2210508061	E453B3A15021I71
422	2210508062	E453B3A15021I72
423	2210508063	E453B3A15021I73
424	2210508064	E453B3A15021I74
425	2210508065	E453B3A15021I75
426	2210508066	E453B3A15021I7A
427	2210508067	E453B3A15021I7B
428	2210508068	E453B3A15021I7C
429	2210508069	E453B3A15021I7D
430	2210508070	E453B3A15021I7E
431	2210508071	E453B3A15021I7G
432	2210508072	E453B3A15021I7H
433	2210508073	E453B3A15021I7K
434	2210508074	E453B3A15021I7L
435	2210508075	E453B3A15021I7M
436	2210508076	E453B3A20011000
437	2210508077	E453B3A20021I71
438	2210508078	E453B3A20021I72
439	2210508079	E453B3A20021I73
440	2210508080	E453B3A20021I74

Pos.	Molex PN:	Engineering No.:
441	2210508081	E453B3A20021I75
442	2210508082	E453B3A20021I7A
443	2210508083	E453B3A20021I7B
444	2210508084	E453B3A20021I7C
445	2210508085	E453B3A20021I7D
446	2210508086	E453B3A20021I7E
447	2210508087	E453B3A20021I7G
448	2210508088	E453B3A20021I7H
449	2210508089	E453B3A20021I7K
450	2210508090	E453B3A20021I7L
451	2210508091	E453B3A20021I7M
452	2210508092	E453B3A30011000
453	2210508093	E453B3A30021I71
454	2210508094	E453B3A30021I72
455	2210508095	E453B3A30021I73
456	2210508096	E453B3A30021I74
457	2210508097	E453B3A30021I75
458	2210508098	E453B3A30021I7A
459	2210508099	E453B3A30021I7B
460	2210508100	E453B3A30021I7C
461	2210508101	E453B3A30021I7D
462	2210508102	E453B3A30021I7E
463	2210508103	E453B3A30021I7G
464	2210508104	E453B3A30021I7H
465	2210508105	E453B3A30021I7K
466	2210508106	E453B3A30021I7L
467	2210508107	E453B3A30021I7M
468	2210508108	E453B3A50011000
469	2210508109	E453B3A50021I71
470	2210508110	E453B3A50021I72
471	2210508111	E453B3A50021I73
472	2210508112	E453B3A50021I74
473	2210508113	E453B3A50021I75
474	2210508114	E453B3A50021I7A
475	2210508115	E453B3A50021I7B
476	2210508116	E453B3A50021I7C
477	2210508117	E453B3A50021I7D
478	2210508118	E453B3A50021I7E
479	2210508119	E453B3A50021I7G
480	2210508120	E453B3A50021I7H

Pos.	Molex PN:	Engineering No.:
481	2210508121	E453B3A50021I7K
482	2210508122	E453B3A50021I7L
483	2210508123	E453B3A50021I7M
484	2210508124	E453I2N10011000
485	2210508125	E453I2N10021I71
486	2210508126	E453I2N10021I72
487	2210508127	E453I2N10021I73
488	2210508128	E453I2N10021I74
489	2210508129	E453I2N10021I75
490	2210508130	E453I2N10021I7A
491	2210508131	E453I2N10021I7B
492	2210508132	E453I2N10021I7C
493	2210508133	E453I2N10021I7D
494	2210508134	E453I2N10021I7E
495	2210508135	E453I2N10021I7G
496	2210508136	E453I2N10021I7H
497	2210508137	E453I2N10021I7K
498	2210508138	E453I2N10021I7L
499	2210508139	E453I2N10021I7M
500	2210508140	E453I2N10021Q01
501	2210508141	E453I2N10021Q02
502	2210508142	E453I2N10021Q03
503	2210508143	E453I2N10021Q04
504	2210508144	E453I2N10021Q05
505	2210508145	E453I2N10021Q0A
506	2210508146	E453I2N10021Q0B
507	2210508147	E453I2N10021Q0C
508	2210508148	E453I2N10021Q0D
509	2210508149	E453I2N10021Q0E
510	2210508150	E453I2N10021Q0G
511	2210508151	E453I2N10021Q0H
512	2210508152	E453I2N10021Q0K
513	2210508153	E453I2N10021Q0L
514	2210508154	E453I2N10021Q0M
515	2210508155	E453I2N10K11000
516	2210508156	E453I2N10K21I71
517	2210508157	E453I2N10K21I72
518	2210508158	E453I2N10K21I73
519	2210508159	E453I2N10K21I74
520	2210508160	E453I2N10K21I75

Pos.	Molex PN:	Engineering No.:
521	2210508161	E453I2N10K21I7A
522	2210508162	E453I2N10K21I7B
523	2210508163	E453I2N10K21I7C
524	2210508164	E453I2N10K21I7D
525	2210508165	E453I2N10K21I7E
526	2210508166	E453I2N10K21I7G
527	2210508167	E453I2N10K21I7H
528	2210508168	E453I2N10K21I7K
529	2210508169	E453I2N10K21I7L
530	2210508170	E453I2N10K21I7M
531	2210508171	E453I2N10K21Q01
532	2210508172	E453I2N10K21Q02
533	2210508173	E453I2N10K21Q03
534	2210508174	E453I2N10K21Q04
535	2210508175	E453I2N10K21Q05
536	2210508176	E453I2N10K21Q0A
537	2210508177	E453I2N10K21Q0B
538	2210508178	E453I2N10K21Q0C
539	2210508179	E453I2N10K21Q0D
540	2210508180	E453I2N10K21Q0E
541	2210508181	E453I2N10K21Q0G
542	2210508182	E453I2N10K21Q0H
543	2210508183	E453I2N10K21Q0K
544	2210508184	E453I2N10K21Q0L
545	2210508185	E453I2N10K21Q0M
546	2210508186	E453I2N15011000
547	2210508187	E453I2N15021I71
548	2210508188	E453I2N15021I72
549	2210508189	E453I2N15021I73
550	2210508190	E453I2N15021I74
551	2210508191	E453I2N15021I75
552	2210508192	E453I2N15021I7A
553	2210508193	E453I2N15021I7B
554	2210508194	E453I2N15021I7C
555	2210508195	E453I2N15021I7D
556	2210508196	E453I2N15021I7E
557	2210508197	E453I2N15021I7G
558	2210508198	E453I2N15021I7H
559	2210508199	E453I2N15021I7K
560	2210508200	E453I2N15021I7L

Pos.	Molex PN:	Engineering No.:
561	2210508201	E453I2N15021I7M
562	2210508202	E453I2N15021Q01
563	2210508203	E453I2N15021Q02
564	2210508204	E453I2N15021Q03
565	2210508205	E453I2N15021Q04
566	2210508206	E453I2N15021Q05
567	2210508207	E453I2N15021Q0A
568	2210508208	E453I2N15021Q0B
569	2210508209	E453I2N15021Q0C
570	2210508210	E453I2N15021Q0D
571	2210508211	E453I2N15021Q0E
572	2210508212	E453I2N15021Q0G
573	2210508213	E453I2N15021Q0H
574	2210508214	E453I2N15021Q0K
575	2210508215	E453I2N15021Q0L
576	2210508216	E453I2N15021Q0M
577	2210508217	E453I2N20011000
578	2210508218	E453I2N20021I71
579	2210508219	E453I2N20021I72
580	2210508220	E453I2N20021I73
581	2210508221	E453I2N20021I74
582	2210508222	E453I2N20021I75
583	2210508223	E453I2N20021I7A
584	2210508224	E453I2N20021I7B
585	2210508225	E453I2N20021I7C
586	2210508226	E453I2N20021I7D
587	2210508227	E453I2N20021I7E
588	2210508228	E453I2N20021I7G
589	2210508229	E453I2N20021I7H
590	2210508230	E453I2N20021I7K
591	2210508231	E453I2N20021I7L
592	2210508232	E453I2N20021I7M
593	2210508233	E453I2N20021Q01
594	2210508234	E453I2N20021Q02
595	2210508235	E453I2N20021Q03
596	2210508236	E453I2N20021Q04
597	2210508237	E453I2N20021Q05
598	2210508238	E453I2N20021Q0A
599	2210508239	E453I2N20021Q0B
600	2210508240	E453I2N20021Q0C

DOCUMENT STATUS: P1 RELEASE DATE: 2020/07/21 04:42:58

THIS DRAWING CONTAINS INFORMATION THAT IS PROPRIETARY TO MOLEX ELECTRONIC TECHNOLOGIES, LLC AND SHOULD NOT BE USED WITHOUT WRITTEN PERMISSION

DIMENSION UNITS	SCALE	CURRENT REV DESC: OBSOLETE PART NUMBERS				
mm	NTS	 E453XXXXXXXXXX DIN FORM A EN 175301-803				
GENERAL TOLERANCES (UNLESS SPECIFIED)					EC NO: 638770	2020/03/05
					DRWN: RPRABHUM	2020/07/21
					CHK'D: GGA	2020/07/21
		APPR: GGA	2020/07/21	PRODUCT CUSTOMER DRAWING		
4 PLACES ±		INITIAL REVISION:	DOCUMENT NUMBER	DOC TYPE	DOC PART	
3 PLACES ±		DRWN: JMARSZALEK	SD-121050-006	PSD	001	
2 PLACES ±		APPR: MIWASIECZKO	2012/11/27	D	REVISION	
1 PLACE ±			2014/01/30			
0 PLACES ±		DRAFT WHERE APPLICABLE MUST REMAIN WITHIN DIMENSIONS	THIRD ANGLE PROJECTION	DRAWING	SERIES	
				A3-SIZE	121050	
				MATERIAL NUMBER	CUSTOMER	
				SEE SHEET 2 & 4	GENERAL MARKET	
					SHEET NUMBER	
					6 OF 10	

TABLE 3 - PART LIST

Pos.	Molex PN:	Engineering No.:
601	2210508241	E453I2N20021Q0D
602	2210508242	E453I2N20021Q0E
603	2210508243	E453I2N20021Q0G
604	2210508244	E453I2N20021Q0H
605	2210508245	E453I2N20021Q0K
606	2210508246	E453I2N20021Q0L
607	2210508247	E453I2N20021Q0M
608	2210508248	E453I2N30011000
609	2210508249	E453I2N30021I71
610	2210508250	E453I2N30021I72
611	2210508251	E453I2N30021I73
612	2210508252	E453I2N30021I74
613	2210508253	E453I2N30021I75
614	2210508254	E453I2N30021I7A
615	2210508255	E453I2N30021I7B
616	2210508256	E453I2N30021I7C
617	2210508257	E453I2N30021I7D
618	2210508258	E453I2N30021I7E
619	2210508259	E453I2N30021I7G
620	2210508260	E453I2N30021I7H
621	2210508261	E453I2N30021I7K
622	2210508262	E453I2N30021I7L
623	2210508263	E453I2N30021I7M
624	2210508264	E453I2N30021Q01
625	2210508265	E453I2N30021Q03
626	2210508266	E453I2N30021Q04
627	2210508267	E453I2N30021Q05
628	2210508268	E453I2N30021Q0A
629	2210508269	E453I2N30021Q0B
630	2210508270	E453I2N30021Q0C
631	2210508271	E453I2N30021Q0D
632	2210508272	E453I2N30021Q0E
633	2210508273	E453I2N30021Q0G
634	2210508274	E453I2N30021Q0H
635	2210508275	E453I2N30021Q0K
636	2210508276	E453I2N30021Q0L
637	2210508277	E453I2N30021Q0M
638	2210508278	E453I2N50011000
639	2210508279	E453I2N50021I71
640	2210508280	E453I2N50021I72

Pos.	Molex PN:	Engineering No.:
641	2210508281	E453I2N50021I73
642	2210508282	E453I2N50021I74
643	2210508283	E453I2N50021I75
644	2210508284	E453I2N50021I7A
645	2210508285	E453I2N50021I7B
646	2210508286	E453I2N50021I7C
647	2210508287	E453I2N50021I7D
648	2210508288	E453I2N50021I7E
649	2210508289	E453I2N50021I7G
650	2210508290	E453I2N50021I7H
651	2210508291	E453I2N50021I7K
652	2210508292	E453I2N50021I7L
653	2210508293	E453I2N50021I7M
654	2210508294	E453I2N50021Q01
655	2210508295	E453I2N50021Q03
656	2210508296	E453I2N50021Q04
657	2210508297	E453I2N50021Q05
658	2210508298	E453I2N50021Q0A
659	2210508299	E453I2N50021Q0B
660	2210508300	E453I2N50021Q0C
661	2210508301	E453I2N50021Q0D
662	2210508302	E453I2N50021Q0E
663	2210508303	E453I2N50021Q0G
664	2210508304	E453I2N50021Q0H
665	2210508305	E453I2N50021Q0K
666	2210508306	E453I2N50021Q0L
667	2210508307	E453I2N50021Q0M
668	2210508308	E453I3N10011000
669	2210508309	E453I3N10021I71
670	2210508310	E453I3N10021I72
671	2210508311	E453I3N10021I73
672	2210508312	E453I3N10021I74
673	2210508313	E453I3N10021I75
674	2210508314	E453I3N10021I7A
675	2210508315	E453I3N10021I7B
676	2210508316	E453I3N10021I7C
677	2210508317	E453I3N10021I7D
678	2210508318	E453I3N10021I7E
679	2210508319	E453I3N10021I7G
680	2210508320	E453I3N10021I7H

Pos.	Molex PN:	Engineering No.:
681	2210508321	E453I3N10021I7K
682	2210508322	E453I3N10021I7L
683	2210508323	E453I3N10021I7M
684	2210508324	E453I3N10021Q01
685	2210508325	E453I3N10021Q02
686	2210508326	E453I3N10021Q03
687	2210508327	E453I3N10021Q04
688	2210508328	E453I3N10021Q05
689	2210508329	E453I3N10021Q0A
690	2210508330	E453I3N10021Q0B
691	2210508331	E453I3N10021Q0C
692	2210508332	E453I3N10021Q0D
693	2210508333	E453I3N10021Q0E
694	2210508334	E453I3N10021Q0G
695	2210508335	E453I3N10021Q0H
696	2210508336	E453I3N10021Q0K
697	2210508337	E453I3N10021Q0L
698	2210508338	E453I3N10021Q0M
699	2210508339	E453I3N10K11000
700	2210508340	E453I3N10K21I71
701	2210508341	E453I3N10K21I72
702	2210508342	E453I3N10K21I73
703	2210508343	E453I3N10K21I74
704	2210508344	E453I3N10K21I75
705	2210508345	E453I3N10K21I7A
706	2210508346	E453I3N10K21I7B
707	2210508347	E453I3N10K21I7C
708	2210508348	E453I3N10K21I7D
709	2210508349	E453I3N10K21I7E
710	2210508350	E453I3N10K21I7G
711	2210508351	E453I3N10K21I7H
712	2210508352	E453I3N10K21I7K
713	2210508353	E453I3N10K21I7L
714	2210508354	E453I3N10K21I7M
715	2210508355	E453I3N10K21Q01
716	2210508356	E453I3N10K21Q02
717	2210508357	E453I3N10K21Q03
718	2210508358	E453I3N10K21Q04
719	2210508359	E453I3N10K21Q05
720	2210508360	E453I3N10K21Q0A

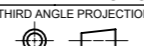
Pos.	Molex PN:	Engineering No.:
721	2210508361	E453I3N10K21Q0B
722	2210508362	E453I3N10K21Q0C
723	2210508363	E453I3N10K21Q0D
724	2210508364	E453I3N10K21Q0E
725	2210508365	E453I3N10K21Q0G
726	2210508366	E453I3N10K21Q0H
727	2210508367	E453I3N10K21Q0K
728	2210508368	E453I3N10K21Q0L
729	2210508369	E453I3N10K21Q0M
730	2210508370	E453I3N15011000
731	2210508371	E453I3N15021I71
732	2210508372	E453I3N15021I72
733	2210508373	E453I3N15021I73
734	2210508374	E453I3N15021I74
735	2210508375	E453I3N15021I75
736	2210508376	E453I3N15021I7A
737	2210508377	E453I3N15021I7B
738	2210508378	E453I3N15021I7C
739	2210508379	E453I3N15021I7D
740	2210508380	E453I3N15021I7E
741	2210508381	E453I3N15021I7G
742	2210508382	E453I3N15021I7H
743	2210508383	E453I3N15021I7K
744	2210508384	E453I3N15021I7L
745	2210508385	E453I3N15021I7M
746	2210508386	E453I3N15021Q01
747	2210508387	E453I3N15021Q02
748	2210508388	E453I3N15021Q03
749	2210508389	E453I3N15021Q04
750	2210508390	E453I3N15021Q05
751	2210508391	E453I3N15021Q0A
752	2210508392	E453I3N15021Q0B
753	2210508393	E453I3N15021Q0C
754	2210508394	E453I3N15021Q0D
755	2210508395	E453I3N15021Q0E
756	2210508396	E453I3N15021Q0G
757	2210508397	E453I3N15021Q0H
758	2210508398	E453I3N15021Q0K
759	2210508399	E453I3N15021Q0L
760	2210508400	E453I3N15021Q0M

Pos.	Molex PN:	Engineering No.:
761	2210508401	E453I3N20011000
762	2210508402	E453I3N20021I71
763	2210508403	E453I3N20021I72
764	2210508404	E453I3N20021I73
765	2210508405	E453I3N20021I74
766	2210508406	E453I3N20021I75
767	2210508407	E453I3N20021I7A
768	2210508408	E453I3N20021I7B
769	2210508409	E453I3N20021I7C
770	2210508410	E453I3N20021I7D
771	2210508411	E453I3N20021I7E
772	2210508412	E453I3N20021I7G
773	2210508413	E453I3N20021I7H
774	2210508414	E453I3N20021I7K
775	2210508415	E453I3N20021I7L
776	2210508416	E453I3N20021I7M
777	2210508417	E453I3N20021Q01
778	2210508418	E453I3N20021Q03
779	2210508419	E453I3N20021Q04
780	2210508420	E453I3N20021Q05
781	2210508421	E453I3N20021Q0A
782	2210508422	E453I3N20021Q0B
783	2210508423	E453I3N20021Q0C
784	2210508424	E453I3N20021Q0D
785	2210508425	E453I3N20021Q0E
786	2210508426	E453I3N20021Q0G
787	2210508427	E453I3N20021Q0H
788	2210508428	E453I3N20021Q0K
789	2210508429	E453I3N20021Q0L
790	2210508430	E453I3N20021Q0M
791	2210508431	E453I3N30011000
792	2210508432	E453I3N30021I71
793	2210508433	E453I3N30021I72
794	2210508434	E453I3N30021I73
795	2210508435	E453I3N30021I74
796	2210508436	E453I3N30021I75
797	2210508437	E453I3N30021I7A
798	2210508438	E453I3N30021I7B
799	2210508439	E453I3N30021I7C
800	2210508440	E453I3N30021I7D

THIS DRAWING CONTAINS INFORMATION THAT IS PROPRIETARY TO MOLEX ELECTRONIC TECHNOLOGIES, LLC AND SHOULD NOT BE USED WITHOUT WRITTEN PERMISSION									
DIMENSION UNITS	SCALE	CURRENT REV DESC: OBSOLETE PART NUMBERS							
mm	NTS	molex E453XXXXXXXXXX DIN FORM A EN 175301-803		EC NO: 638770 DRWN: RPRABHUM 2020/03/05 CHK'D: GGA 2020/07/21 APPR: GGA 2020/07/21 INITIAL REVISION: DRWN: JMARSZALEK 2012/11/27 APPR: MIWASIECZKO 2014/01/30					
GENERAL TOLERANCES (UNLESS SPECIFIED)									
	MM INCH								
4 PLACES ±	±								
3 PLACES ±	±								
2 PLACES ±	±								
1 PLACE ±	±								
0 PLACES ±	±	DOCUMENT NUMBER				DOC TYPE	DOC PART	REVISION	
ANGULAR TOL ± °	± °	SD-121050-006		PSD	001	D			
DRAFT WHERE APPLICABLE MUST REMAIN WITHIN DIMENSIONS		THIRD ANGLE PROJECTION	DRAWING	SERIES	MATERIAL NUMBER	CUSTOMER	SHEET NUMBER		
			A3-SIZE	121050	SEE SHEET 2 & 4	GENERAL MARKET	7 OF 10		

TABLE 3 - PART LIST

Pos.	Molex PN:	Engineering No.:
801	2210508441	E453I3N30021I7E
802	2210508442	E453I3N30021I7G
803	2210508443	E453I3N30021I7H
804	2210508444	E453I3N30021I7K
805	2210508445	E453I3N30021I7L
806	2210508446	E453I3N30021I7M
807	2210508447	E453I3N30021Q01
808	2210508448	E453I3N30021Q03
809	2210508449	E453I3N30021Q04
810	2210508450	E453I3N30021Q05
811	2210508451	E453I3N30021Q0A
812	2210508452	E453I3N30021Q0B
813	2210508453	E453I3N30021Q0C
814	2210508454	E453I3N30021Q0D
815	2210508455	E453I3N30021Q0E
816	2210508456	E453I3N30021Q0G
817	2210508457	E453I3N30021Q0H
818	2210508458	E453I3N30021Q0K
819	2210508459	E453I3N30021Q0L
820	2210508460	E453I3N30021Q0M
821	2210508461	E453I3N50011000
822	2210508462	E453I3N50021I71
823	2210508463	E453I3N50021I72
824	2210508464	E453I3N50021I73
825	2210508465	E453I3N50021I74
826	2210508466	E453I3N50021I75
827	2210508467	E453I3N50021I7A
828	2210508468	E453I3N50021I7B
829	2210508469	E453I3N50021I7C
830	2210508470	E453I3N50021I7D
831	2210508471	E453I3N50021I7E
832	2210508472	E453I3N50021I7G
833	2210508473	E453I3N50021I7H
834	2210508474	E453I3N50021I7K
835	2210508475	E453I3N50021I7L
836	2210508476	E453I3N50021I7M
837	2210508477	E453I3N50021Q01
838	2210508478 VO	E453I3N50021Q02
839	2210508479	E453I3N50021Q03
840	2210508480	E453I3N50021Q04

Pos.	Molex PN:	Engineering No.:
841	2210508481	E453I3N50021Q05
842	2210508482	E453I3N50021Q0A
843	2210508483	E453I3N50021Q0B
844	2210508484	E453I3N50021Q0C
845	2210508485	E453I3N50021Q0D
846	2210508486	E453I3N50021Q0E
847	2210508487	E453I3N50021Q0G
848	2210508488	E453I3N50021Q0H
849	2210508489	E453I3N50021Q0K
850	2210508490	E453I3N50021Q0L
851	2210508491	E453I3N50021Q0M
852	2210508492	E453N2N10011000
853	2210508493	E453N2N10021I71
854	2210508494	E453N2N10021I72
855	2210508495	E453N2N10021I73
856	2210508496	E453N2N10021I74
857	2210508497	E453N2N10021I75
858	2210508498	E453N2N10021I7A
859	2210508499	E453N2N10021I7B
860	2210508500	E453N2N10021I7C
861	2210508501	E453N2N10021I7D
862	2210508502	E453N2N10021I7E
863	2210508503	E453N2N10021I7G
864	2210508504	E453N2N10021I7H
865	2210508505	E453N2N10021I7K
866	2210508506	E453N2N10021I7L
867	2210508507	E453N2N10021I7M
868	2210508508	E453N2N10K11000
869	2210508509	E453N2N10K21I71
870	2210508510	E453N2N10K21I72
871	2210508511	E453N2N10K21I73
872	2210508512	E453N2N10K21I74
873	2210508513	E453N2N10K21I75
874	2210508514	E453N2N10K21I7A
875	2210508515	E453N2N10K21I7B
876	2210508516	E453N2N10K21I7C
877	2210508517	E453N2N10K21I7D
878	2210508518	E453N2N10K21I7E
879	2210508519	E453N2N10K21I7G
880	2210508520	E453N2N10K21I7H

Pos.	Molex PN:	Engineering No.:
881	2210508521	E453N2N10K21I7K
882	2210508522	E453N2N10K21I7L
883	2210508523	E453N2N10K21I7M
884	2210508524	E453N2N15011000
885	2210508525	E453N2N15021I71
886	2210508526	E453N2N15021I72
887	2210508527	E453N2N15021I73
888	2210508528	E453N2N15021I74
889	2210508529	E453N2N15021I75
890	2210508530	E453N2N15021I7A
891	2210508531	E453N2N15021I7B
892	2210508532	E453N2N15021I7C
893	2210508533	E453N2N15021I7D
894	2210508534	E453N2N15021I7E
895	2210508535	E453N2N15021I7G
896	2210508536	E453N2N15021I7H
897	2210508537	E453N2N15021I7K
898	2210508538	E453N2N15021I7L
899	2210508539	E453N2N15021I7M
900	2210508540	E453N2N20011000
901	2210508541	E453N2N20021I71
902	2210508542	E453N2N20021I72
903	2210508543	E453N2N20021I73
904	2210508544	E453N2N20021I74
905	2210508545	E453N2N20021I75
906	2210508546	E453N2N20021I7A
907	2210508547	E453N2N20021I7B
908	2210508548	E453N2N20021I7C
909	2210508549	E453N2N20021I7D
910	2210508550	E453N2N20021I7E
911	2210508551	E453N2N20021I7G
912	2210508552	E453N2N20021I7H
913	2210508553	E453N2N20021I7K
914	2210508554	E453N2N20021I7L
915	2210508555	E453N2N20021I7M
916	2210508556	E453N2N30011000
917	2210508557	E453N2N30021I71
918	2210508558	E453N2N30021I72
919	2210508559	E453N2N30021I73
920	2210508560	E453N2N30021I74

Pos.	Molex PN:	Engineering No.:
921	2210508561	E453N2N30021I75
922	2210508562	E453N2N30021I7A
923	2210508563	E453N2N30021I7B
924	2210508564	E453N2N30021I7C
925	2210508565	E453N2N30021I7D
926	2210508566	E453N2N30021I7E
927	2210508567	E453N2N30021I7G
928	2210508568	E453N2N30021I7H
929	2210508569	E453N2N30021I7K
930	2210508570	E453N2N30021I7L
931	2210508571	E453N2N30021I7M
932	2210508572	E453N2N50011000
933	2210508573	E453N2N50021I71
934	2210508574	E453N2N50021I72
935	2210508575	E453N2N50021I73
936	2210508576	E453N2N50021I74
937	2210508577	E453N2N50021I75
938	2210508578	E453N2N50021I7A
939	2210508579	E453N2N50021I7B
940	2210508580	E453N2N50021I7C
941	2210508581	E453N2N50021I7D
942	2210508582	E453N2N50021I7E
943	2210508583	E453N2N50021I7G
944	2210508584	E453N2N50021I7H
945	2210508585	E453N2N50021I7K
946	2210508586	E453N2N50021I7L
947	2210508587	E453N2N50021I7M
948	2210508588	E453N3N10011000
949	2210508589	E453N3N10021I71
950	2210508590	E453N3N10021I72
951	2210508591	E453N3N10021I73
952	2210508592	E453N3N10021I74
953	2210508593	E453N3N10021I75
954	2210508594	E453N3N10021I7A
955	2210508595	E453N3N10021I7B
956	2210508596	E453N3N10021I7C
957	2210508597	E453N3N10021I7D
958	2210508598	E453N3N10021I7E
959	2210508599	E453N3N10021I7G
960	2210508600	E453N3N10021I7H

Pos.	Molex PN:	Engineering No.:
961	2210508601	E453N3N10021I7K
962	2210508602	E453N3N10021I7L
963	2210508603	E453N3N10021I7M
964	2210508604	E453N3N10021Q01
965	2210508605	E453N3N10021Q02
966	2210508606	E453N3N10021Q03
967	2210508607	E453N3N10021Q04
968	2210508608	E453N3N10021Q05
969	2210508609	E453N3N10021Q0A
970	2210508610	E453N3N10021Q0B
971	2210508611	E453N3N10021Q0C
972	2210508612	E453N3N10021Q0D
973	2210508613	E453N3N10021Q0E
974	2210508614	E453N3N10021Q0G
975	2210508615	E453N3N10021Q0H
976	2210508616	E453N3N10021Q0K
977	2210508617	E453N3N10021Q0L
978	2210508618	E453N3N10021Q0M
979	2210508619	E453N3N10K11000
980	2210508620	E453N3N10K21I71
981	2210508621	E453N3N10K21I72
982	2210508622	E453N3N10K21I73
983	2210508623	E453N3N10K21I74
984	2210508624	E453N3N10K21I75
985	2210508625	E453N3N10K21I7A
986	2210508626	E453N3N10K21I7B
987	2210508627	E453N3N10K21I7C
988	2210508628	E453N3N10K21I7D
989	2210508629	E453N3N10K21I7E
990	2210508630	E453N3N10K21I7G
991	2210508631	E453N3N10K21I7H
992	2210508632	E453N3N10K21I7K
993	2210508633	E453N3N10K21I7L
994	2210508634	E453N3N10K21I7M
995	2210508635	E453N3N10K21Q01
996	2210508636	E453N3N10K21Q02
997	2210508637	E453N3N10K21Q03
998	2210508638	E453N3N10K21Q04
999	2210508639	E453N3N10K21Q05
1000	2210508640	E453N3N10K21Q0A

THIS DRAWING CONTAINS INFORMATION THAT IS PROPRIETARY TO MOLEX ELECTRONIC TECHNOLOGIES, LLC AND SHOULD NOT BE USED WITHOUT WRITTEN PERMISSION		CURRENT REV DESC: OBSOLETE PART NUMBERS		molex																			
DIMENSION UNITS: mm SCALE: NTS				E453XXXXXXXXXX DIN FORM A EN 175301-803																			
GENERAL TOLERANCES (UNLESS SPECIFIED)				PRODUCT CUSTOMER DRAWING																			
<table border="1"> <tr><th></th><th>MM</th><th>INCH</th></tr> <tr><td>4 PLACES</td><td>±</td><td>±</td></tr> <tr><td>3 PLACES</td><td>±</td><td>±</td></tr> <tr><td>2 PLACES</td><td>±</td><td>±</td></tr> <tr><td>1 PLACE</td><td>±</td><td>±</td></tr> <tr><td>0 PLACES</td><td>±</td><td>±</td></tr> </table>			MM	INCH	4 PLACES	±	±	3 PLACES	±	±	2 PLACES	±	±	1 PLACE	±	±	0 PLACES	±	±	EC NO: 638770 DRWN: RPRABHUM 2020/03/05 CHK'D: GGA 2020/07/21 APPR: GGA 2020/07/21		DOCUMENT NUMBER: SD-121050-006	
	MM	INCH																					
4 PLACES	±	±																					
3 PLACES	±	±																					
2 PLACES	±	±																					
1 PLACE	±	±																					
0 PLACES	±	±																					
INITIAL REVISION: DRWN: JMARSZALEK 2012/11/27 APPR: MIWASIECZKO 2014/01/30		DOC TYPE: PSD DOC PART: 001 REVISION: D																					
DRAFT WHERE APPLICABLE MUST REMAIN WITHIN DIMENSIONS		THIRD ANGLE PROJECTION		DRAWING: A3-SIZE SERIES: 121050 MATERIAL NUMBER: SEE SHEET 2 & 4 CUSTOMER: GENERAL MARKET SHEET NUMBER: 8 OF 10																			

TABLE 3 - PART LIST

Pos.	Molex PN:	Engineering No.:
1001	2210508641	E453N3N10K21Q0B
1002	2210508642	E453N3N10K21Q0C
1003	2210508643	E453N3N10K21Q0D
1004	2210508644	E453N3N10K21Q0E
1005	2210508645	E453N3N10K21Q0G
1006	2210508646	E453N3N10K21Q0H
1007	2210508647	E453N3N10K21Q0K
1008	2210508648	E453N3N10K21Q0L
1009	2210508649	E453N3N10K21Q0M
1010	2210508650	E453N3N15011000
1011	2210508651	E453N3N15021I71
1012	2210508652	E453N3N15021I72
1013	2210508653	E453N3N15021I73
1014	2210508654	E453N3N15021I74
1015	2210508655	E453N3N15021I75
1016	2210508656	E453N3N15021I7A
1017	2210508657	E453N3N15021I7B
1018	2210508658	E453N3N15021I7C
1019	2210508659	E453N3N15021I7D
1020	2210508660	E453N3N15021I7E
1021	2210508661	E453N3N15021I7G
1022	2210508662	E453N3N15021I7H
1023	2210508663	E453N3N15021I7K
1024	2210508664	E453N3N15021I7L
1025	2210508665	E453N3N15021I7M
1026	2210508666	E453N3N15021Q01
1027	2210508667 VO	E453N3N15021Q02
1028	2210508668 VO	E453N3N15021Q03
1029	2210508669 VO	E453N3N15021Q04
1030	2210508670 VO	E453N3N15021Q05
1031	2210508671 VO	E453N3N15021Q0A
1032	2210508672 VO	E453N3N15021Q0B
1033	2210508673 VO	E453N3N15021Q0C
1034	2210508674 VO	E453N3N15021Q0D
1035	2210508675 VO	E453N3N15021Q0E
1036	2210508676 VO	E453N3N15021Q0G
1037	2210508677 VO	E453N3N15021Q0H
1038	2210508678 VO	E453N3N15021Q0K
1039	2210508679 VO	E453N3N15021Q0L
1040	2210508680 VO	E453N3N15021Q0M

Pos.	Molex PN:	Engineering No.:
1041	2210508681 VO	E453N3N20011000
1042	2210508682 VO	E453N3N20021I71
1043	2210508683 VO	E453N3N20021I72
1044	2210508684 VO	E453N3N20021I73
1045	2210508685 VO	E453N3N20021I74
1046	2210508686 VO	E453N3N20021I75
1047	2210508687 VO	E453N3N20021I7A
1048	2210508688 VO	E453N3N20021I7B
1049	2210508689 VO	E453N3N20021I7C
1050	2210508690 VO	E453N3N20021I7D
1051	2210508691 VO	E453N3N20021I7E
1052	2210508692 VO	E453N3N20021I7G
1053	2210508693 VO	E453N3N20021I7H
1054	2210508694 VO	E453N3N20021I7K
1055	2210508695 VO	E453N3N20021I7L
1056	2210508696 VO	E453N3N20021I7M
1057	2210508697 VO	E453N3N20021Q01
1058	2210508698	E453N3N20021Q02
1059	2210508699 VO	E453N3N20021Q03
1060	2210508700 VO	E453N3N20021Q04
1061	2210508701 VO	E453N3N20021Q05
1062	2210508702 VO	E453N3N20021Q0A
1063	2210508703 VO	E453N3N20021Q0B
1064	2210508704 VO	E453N3N20021Q0C
1065	2210508705 VO	E453N3N20021Q0D
1066	2210508706 VO	E453N3N20021Q0E
1067	2210508707 VO	E453N3N20021Q0G
1068	2210508708 VO	E453N3N20021Q0H
1069	2210508709 VO	E453N3N20021Q0K
1070	2210508710 VO	E453N3N20021Q0L
1071	2210508711 VO	E453N3N20021Q0M
1072	2210508712 VO	E453N3N30011000
1073	2210508713 VO	E453N3N30021I71
1074	2210508714 VO	E453N3N30021I72
1075	2210508715 VO	E453N3N30021I73
1076	2210508716 VO	E453N3N30021I74
1077	2210508717 VO	E453N3N30021I75
1078	2210508718 VO	E453N3N30021I7A
1079	2210508719 VO	E453N3N30021I7B
1080	2210508720 VO	E453N3N30021I7C

Pos.	Molex PN:	Engineering No.:
1081	2210508721 VO	E453N3N30021I7D
1082	2210508722 VO	E453N3N30021I7E
1083	2210508723 VO	E453N3N30021I7G
1084	2210508724 VO	E453N3N30021I7H
1085	2210508725 VO	E453N3N30021I7K
1086	2210508726 VO	E453N3N30021I7L
1087	2210508727 VO	E453N3N30021I7M
1088	2210508728 VO	E453N3N30021Q01
1089	2210508729 VO	E453N3N30021Q03
1090	2210508730 VO	E453N3N30021Q04
1091	2210508731 VO	E453N3N30021Q05
1092	2210508732 VO	E453N3N30021Q0A
1093	2210508733 VO	E453N3N30021Q0B
1094	2210508734 VO	E453N3N30021Q0C
1095	2210508735 VO	E453N3N30021Q0D
1096	2210508736 VO	E453N3N30021Q0E
1097	2210508737 VO	E453N3N30021Q0G
1098	2210508738 VO	E453N3N30021Q0H
1099	2210508739 VO	E453N3N30021Q0K
1100	2210508740 VO	E453N3N30021Q0L
1101	2210508741 VO	E453N3N30021Q0M
1102	2210508742 VO	E453N3N50011000
1103	2210508743 VO	E453N3N50021I71
1104	2210508744 VO	E453N3N50021I72
1105	2210508745 VO	E453N3N50021I73
1106	2210508746 VO	E453N3N50021I74
1107	2210508747 VO	E453N3N50021I75
1108	2210508748 VO	E453N3N50021I7A
1109	2210508749 VO	E453N3N50021I7B
1110	2210508750 VO	E453N3N50021I7C
1111	2210508751 VO	E453N3N50021I7D
1112	2210508752 VO	E453N3N50021I7E
1113	2210508753 VO	E453N3N50021I7G
1114	2210508754 VO	E453N3N50021I7H
1115	2210508755 VO	E453N3N50021I7K
1116	2210508756 VO	E453N3N50021I7L
1117	2210508757 VO	E453N3N50021I7M
1118	2210508758 VO	E453N3N50021Q01
1119	2210508759	E453N3N50021Q02
1120	2210508760 VO	E453N3N50021Q03

Pos.	Molex PN:	Engineering No.:
1121	2210508761 VO	E453N3N50021Q04
1122	2210508762 VO	E453N3N50021Q05
1123	2210508763 VO	E453N3N50021Q0A
1124	2210508764	E453N3N50021Q0B
1125	2210508765 VO	E453N3N50021Q0C
1126	2210508766 VO	E453N3N50021Q0D
1127	2210508767 VO	E453N3N50021Q0E
1128	2210508768 VO	E453N3N50021Q0G
1129	2210508769 VO	E453N3N50021Q0H
1130	2210508770 VO	E453N3N50021Q0K
1131	2210508771 VO	E453N3N50021Q0L
1132	2210508772 VO	E453N3N50021Q0M
1133	2210508773 VO	E453P2N10021Q01
1134	2210508774 VO	E453P2N10021Q02
1135	2210508775 VO	E453P2N10021Q03
1136	2210508776 VO	E453P2N10021Q04
1137	2210508777 VO	E453P2N10021Q05
1138	2210508778 VO	E453P2N10021Q0A
1139	2210508779 VO	E453P2N10021Q0B
1140	2210508780 VO	E453P2N10021Q0C
1141	2210508781 VO	E453P2N10021Q0D
1142	2210508782 VO	E453P2N10021Q0E
1143	2210508783 VO	E453P2N10021Q0G
1144	2210508784 VO	E453P2N10021Q0H
1145	2210508785 VO	E453P2N10021Q0K
1146	2210508786 VO	E453P2N10021Q0L
1147	2210508787 VO	E453P2N10021Q0M
1148	2210508788 VO	E453P2N10K21Q01
1149	2210508789	E453P2N10K21Q02
1150	2210508790 VO	E453P2N10K21Q03
1151	2210508791 VO	E453P2N10K21Q04
1152	2210508792 VO	E453P2N10K21Q05
1153	2210508793 VO	E453P2N10K21Q0A
1154	2210508794 VO	E453P2N10K21Q0B
1155	2210508795 VO	E453P2N10K21Q0C
1156	2210508796 VO	E453P2N10K21Q0D
1157	2210508797	E453P2N10K21Q0E
1158	2210508798	E453P2N10K21Q0G
1159	2210508799	E453P2N10K21Q0H
1160	2210508800	E453P2N10K21Q0K

Pos.	Molex PN:	Engineering No.:
1161	2210508801	E453P2N10K21Q0L
1162	2210508802	E453P2N10K21Q0M
1163	2210508803	E453P2N15021Q01
1164	2210508804	E453P2N15021Q02
1165	2210508805	E453P2N15021Q03
1166	2210508806	E453P2N15021Q04
1167	2210508807	E453P2N15021Q05
1168	2210508808	E453P2N15021Q0A
1169	2210508809	E453P2N15021Q0B
1170	2210508810	E453P2N15021Q0C
1171	2210508811	E453P2N15021Q0D
1172	2210508812	E453P2N15021Q0E
1173	2210508813	E453P2N15021Q0G
1174	2210508814	E453P2N15021Q0H
1175	2210508815	E453P2N15021Q0K
1176	2210508816	E453P2N15021Q0L
1177	2210508817	E453P2N15021Q0M
1178	2210508818	E453P2N20021Q01
1179	2210508819	E453P2N20021Q02
1180	2210508820	E453P2N20021Q03
1181	2210508821	E453P2N20021Q04
1182	2210508822	E453P2N20021Q05
1183	2210508823	E453P2N20021Q0A
1184	2210508824	E453P2N20021Q0B
1185	2210508825	E453P2N20021Q0C
1186	2210508826	E453P2N20021Q0D
1187	2210508827	E453P2N20021Q0E
1188	2210508828	E453P2N20021Q0G
1189	2210508829	E453P2N20021Q0H
1190	2210508830	E453P2N20021Q0K
1191	2210508831	E453P2N20021Q0L
1192	2210508832	E453P2N20021Q0M
1193	2210508833	E453P2N30021Q03
1194	2210508834	E453P2N30021Q04
1195	2210508835	E453P2N30021Q05
1196	2210508836	E453P2N30021Q0A
1197	2210508837	E453P2N30021Q0B
1198	2210508838	E453P2N30021Q0C
1199	2210508839	E453P2N30021Q0D
1200	2210508840	E453P2N30021Q0E

THIS DRAWING CONTAINS INFORMATION THAT IS PROPRIETARY TO MOLEX ELECTRONIC TECHNOLOGIES, LLC AND SHOULD NOT BE USED WITHOUT WRITTEN PERMISSION			
DIMENSION UNITS	SCALE	CURRENT REV DESC: OBSOLETE PART NUMBERS	
mm	NTS		
GENERAL TOLERANCES (UNLESS SPECIFIED)			
	MM	INCH	
4 PLACES	±	±	
3 PLACES	±	±	
2 PLACES	±	±	
1 PLACE	±	±	
0 PLACES	±	±	
ANGULAR TOL	±	°	
DRAFT WHERE APPLICABLE MUST REMAIN WITHIN DIMENSIONS		THIRD ANGLE PROJECTION	DRAWING SERIES
			A3-SIZE 121050
		MATERIAL NUMBER	CUSTOMER
		SEE SHEET 2 & 4	GENERAL MARKET
		SHEET NUMBER	9 OF 10
		EC NO: 638770	
		DRWN: RPRABHUM	2020/03/05
		CHK'D: GGA	2020/07/21
		APPR: GGA	2020/07/21
		INITIAL REVISION:	
		DRWN: JMARSZALEK	2012/11/27
		APPR: MIWASIECZKO	2014/01/30
		DOCUMENT NUMBER	DOC TYPE DOC PART REVISION
		SD-121050-006	PSD 001 D



molex

E453XXXXXXXXXX
DIN FORM A EN 175301-803

PRODUCT CUSTOMER DRAWING

TABLE 3 - PART LIST

Pos.	Molex PN:	Engineering No.:	Pos.	Molex PN:	Engineering No.:	Pos.	Molex PN:	Engineering No.:	Pos.	Molex PN:	Engineering No.:	Pos.	Molex PN:	Engineering No.:
1201	2210508841	E453P2N30021Q0G	1241	2210508881	E453P3N10K21175	1281	2210508921	E453P3N2002117K						
1202	2210508842	E453P2N30021Q0H	1242	2210508882	E453P3N10K2117A	1282	2210508922	E453P3N2002117L						
1203	2210508843	E453P2N30021Q0K	1243	2210508883	E453P3N10K2117B	1283	2210508923	E453P3N2002117M						
1204	2210508844	E453P2N30021Q0L	1244	2210508884	E453P3N10K2117C	1284	2210508924	E453P3N30011000						
1205	2210508845	E453P2N30021Q0M	1245	2210508885	E453P3N10K2117D	1285	2210508925	E453P3N30021171						
1206	2210508846	E453P2N50021Q01	1246	2210508886	E453P3N10K2117E	1286	2210508926	E453P3N30021172						
1207	2210508847	E453P2N50021Q03	1247	2210508887	E453P3N10K2117G	1287	2210508927	E453P3N30021173						
1208	2210508848	E453P2N50021Q04	1248	2210508888	E453P3N10K2117H	1288	2210508928	E453P3N30021174						
1209	2210508849	E453P2N50021Q05	1249	2210508889	E453P3N10K2117K	1289	2210508929	E453P3N30021175						
1210	2210508850	E453P2N50021Q0A	1250	2210508890	E453P3N10K2117L	1290	2210508930	E453P3N3002117A						
1211	2210508851	E453P2N50021Q0B	1251	2210508891	E453P3N10K2117M	1291	2210508931	E453P3N3002117B						
1212	2210508852	E453P2N50021Q0C	1252	2210508892	E453P3N15011000	1292	2210508932	E453P3N3002117C						
1213	2210508853	E453P2N50021Q0D	1253	2210508893	E453P3N15021171	1293	2210508933	E453P3N3002117D						
1214	2210508854	E453P2N50021Q0E	1254	2210508894	E453P3N15021172	1294	2210508934	E453P3N3002117E						
1215	2210508855	E453P2N50021Q0G	1255	2210508895	E453P3N15021173	1295	2210508935	E453P3N3002117G						
1216	2210508856	E453P2N50021Q0H	1256	2210508896	E453P3N15021174	1296	2210508936	E453P3N3002117H						
1217	2210508857	E453P2N50021Q0K	1257	2210508897	E453P3N15021175	1297	2210508937	E453P3N3002117K						
1218	2210508858	E453P2N50021Q0L	1258	2210508898	E453P3N1502117A	1298	2210508938	E453P3N3002117L						
1219	2210508859	E453P2N50021Q0M	1259	2210508899	E453P3N1502117B	1299	2210508939	E453P3N3002117M						
1220	2210508860	E453P3N10011000	1260	2210508900	E453P3N1502117C	1300	2210508940	E453P3N50011000						
1221	2210508861	E453P3N10021171	1261	2210508901	E453P3N1502117D	1301	2210508941	E453P3N50021171						
1222	2210508862	E453P3N10021172	1262	2210508902	E453P3N1502117E	1302	2210508942	E453P3N50021172						
1223	2210508863	E453P3N10021173	1263	2210508903	E453P3N1502117G	1303	2210508943	E453P3N50021173						
1224	2210508864	E453P3N10021174	1264	2210508904	E453P3N1502117H	1304	2210508944	E453P3N50021174						
1225	2210508865	E453P3N10021175	1265	2210508905	E453P3N1502117K	1305	2210508945	E453P3N50021175						
1226	2210508866	E453P3N1002117A	1266	2210508906	E453P3N1502117L	1306	2210508946	E453P3N5002117A						
1227	2210508867	E453P3N1002117B	1267	2210508907	E453P3N1502117M	1307	2210508947	E453P3N5002117B						
1228	2210508868	E453P3N1002117C	1268	2210508908	E453P3N20011000	1308	2210508948	E453P3N5002117C						
1229	2210508869	E453P3N1002117D	1269	2210508909	E453P3N20021171	1309	2210508949	E453P3N5002117D						
1230	2210508870	E453P3N1002117E	1270	2210508910	E453P3N20021172	1310	2210508950	E453P3N5002117E						
1231	2210508871	E453P3N1002117G	1271	2210508911	E453P3N20021173	1311	2210508951	E453P3N5002117G						
1232	2210508872	E453P3N1002117H	1272	2210508912	E453P3N20021174	1312	2210508952	E453P3N5002117H						
1233	2210508873	E453P3N1002117K	1273	2210508913	E453P3N20021175	1313	2210508953	E453P3N5002117K						
1234	2210508874	E453P3N1002117L	1274	2210508914	E453P3N2002117A	1314	2210508954	E453P3N5002117L						
1235	2210508875	E453P3N1002117M	1275	2210508915	E453P3N2002117B	1315	2210508955	E453P3N5002117M						
1236	2210508876	E453P3N10K11000	1276	2210508916	E453P3N2002117C	1316	1210500877	E453P2G50062Q02						
1237	2210508877	E453P3N10K21171	1277	2210508917	E453P3N2002117D	1317	1210503525	E453P2N15K61Q12						
1238	2210508878	E453P3N10K21172	1278	2210508918	E453P3N2002117E	1318	1210503585	E453B3A3002PQ02						
1239	2210508879	E453P3N10K21173	1279	2210508919	E453P3N2002117G									
1240	2210508880	E453P3N10K21174	1280	2210508920	E453P3N2002117H									

THIS DRAWING CONTAINS INFORMATION THAT IS PROPRIETARY TO MOLEX ELECTRONIC TECHNOLOGIES, LLC AND SHOULD NOT BE USED WITHOUT WRITTEN PERMISSION									
DIMENSION UNITS		SCALE		CURRENT REV DESC: OBSOLETE PART NUMBERS					
mm		NTS							
GENERAL TOLERANCES (UNLESS SPECIFIED)				EC NO: 638770		2020/03/05		E453XXXXXXXXXX	
				DRWN: RPRABHUM		2020/07/21		DIN FORM A EN 175301-803	
				CHK'D: GGA		2020/07/21		PRODUCT CUSTOMER DRAWING	
				APPR: GGA		2020/07/21		DOCUMENT NUMBER	
				INITIAL REVISION:				DOC TYPE DOC PART REVISION	
				DRWN: JMARSZALEK		2012/11/27		SD-121050-006	
				APPR: MIWASIECZKO		2014/01/30		PSD 001 D	
ANGULAR TOL ± °				THIRD ANGLE PROJECTION		DRAWING		SERIES	
DRAFT WHERE APPLICABLE MUST REMAIN WITHIN DIMENSIONS						A3-SIZE		MATERIAL NUMBER	
						121050		CUSTOMER	
						SEE SHEET 2 & 4		GENERAL MARKET	
								SHEET NUMBER	
								10 OF 10	