

Pulse transformers
For LAN interface (10/100/1000BASE-T)
ALT series



ALT3232M, ALT4532M type



FEATURES

- The ALT series contains wound chip type pulse transformers developed for LANs.
- Compatible with 10BASE-T, 100BASE-TX, and 1000BASE-T.
- High-quality product that uses auto winding.
- Conforms to the RoHS directive.
- Operating temperature range: -40 to +85°C (including self-temperature rise)

APPLICATION

- LAN interfaces of various devices including network devices, communication equipment, digital consumer electronics, etc.

PART NUMBER CONSTRUCTION

ALT	3232	M	151	T	001
Series name	LxWxH dimensions 3.2x3.2x2.9mm 4.5x3.2x2.2mm 4.5x3.2x2.9mm	Product internal code	Inductance (μH min.) at 100kHz/DC bias=8mA	Packaging style	Internal code

CHARACTERISTICS SPECIFICATION TABLE

Turn ratio ①⑥② : ⑤③④	Inductance [DC bias 8mA, 100kHz] ①-② ⑤-④ (μH)min.	Insertion loss [0.1 to 100MHz] ①②-⑤④ (dB)max.	Inter-winding stray capacitance [100kHz] (pF)max.	Thickness T (mm)max.	Part No.
1CT : 1CT	150	2.5	25	2.9	ALT3232M-151-T001
1CT : 1CT	170	2.5	35	2.2	ALT4532M-171-T001
1CT : 1CT	200	1.5	35	2.9	ALT4532M-201-T001

Measurement equipment

Measurement item	Product No.	Manufacturer
Inductance	4284A	Keysight Technologies
Insertion loss	E5071C	Keysight Technologies
Inter-winding stray capacitance	4284A	Keysight Technologies

* Equivalent measurement equipment may be used.

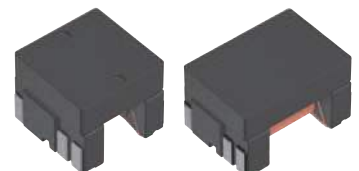

ALT3232M, ALT4532M type

■ INSERTION LOSS VS. FREQUENCY CHARACTERISTICS

ALT3232M type

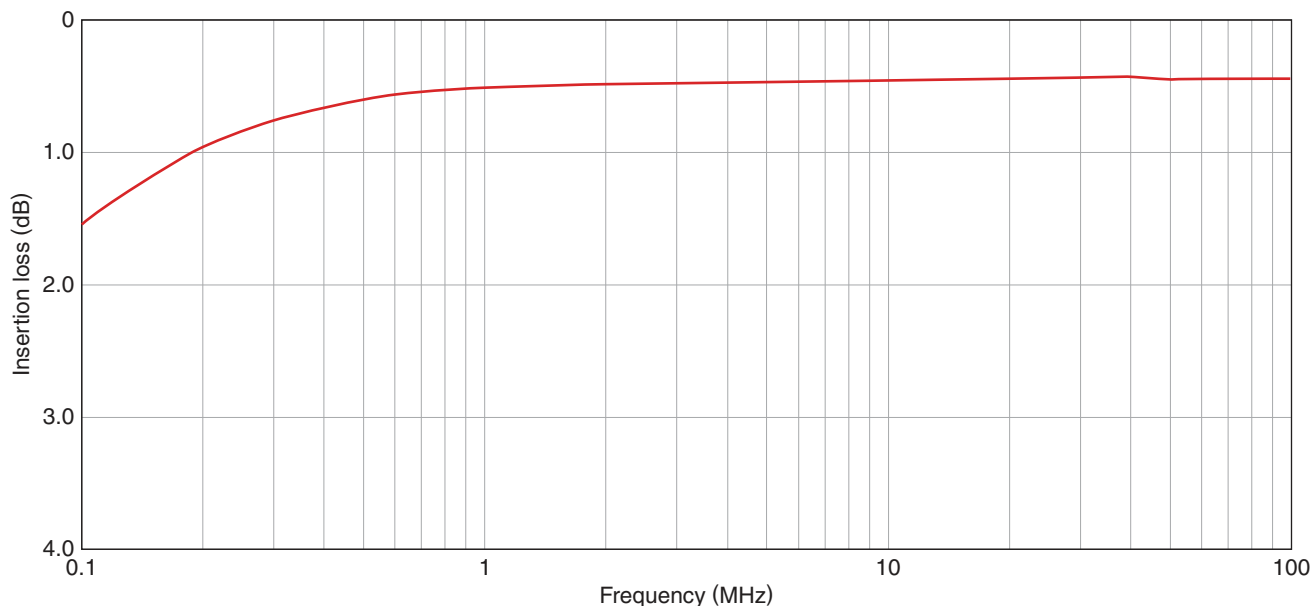

Measurement equipment

Product No.	Manufacturer
E5071C	Keysight Technologies

* Equivalent measurement equipment may be used.

ALT4532M type

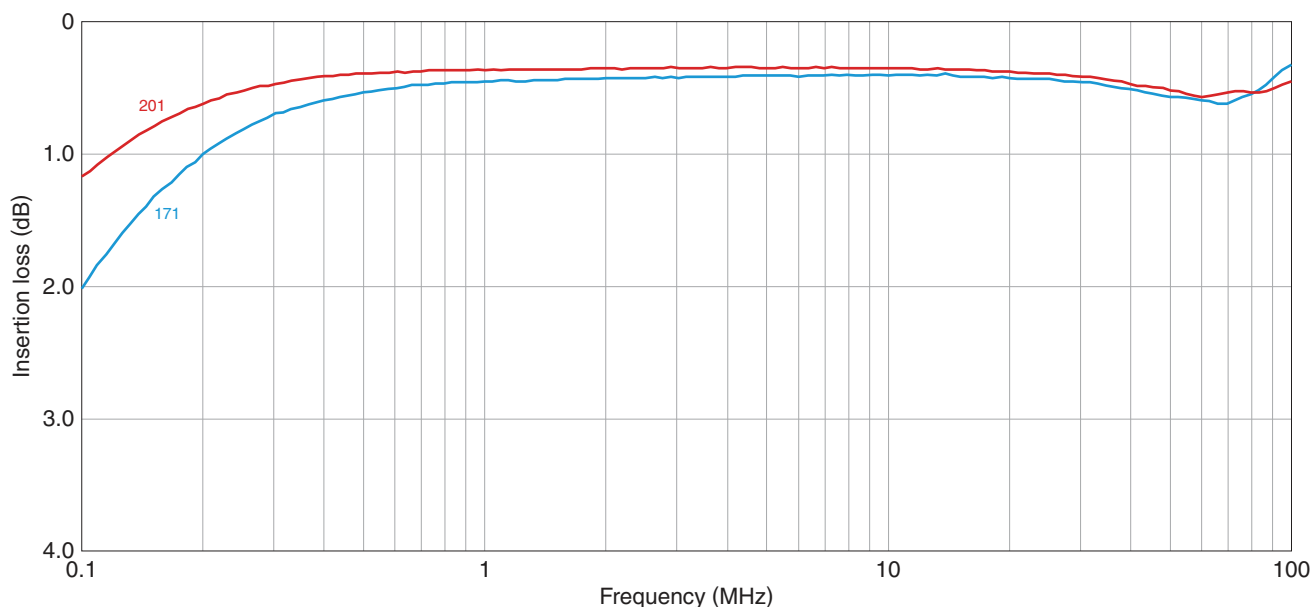

Measurement equipment

Product No.	Manufacturer
E5071C	Keysight Technologies

* Equivalent measurement equipment may be used.

ALT3232M, ALT4532M type

SHAPE & DIMENSIONS

ALT3232M

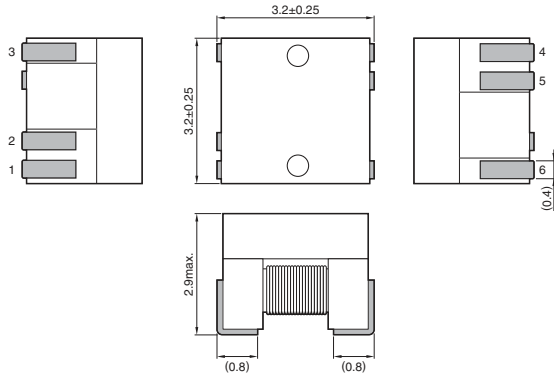

ALT4532M

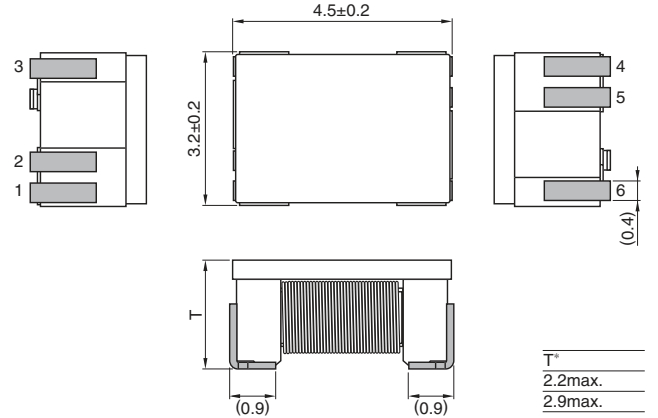

Dimensions in mm

RECOMMENDED LAND PATTERN

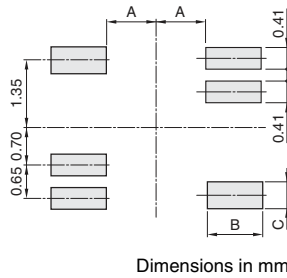

Dimensions in mm

Part No.	A	B	C
ALT3232M	0.9	1.0	0.41
ALT4532M-171	1.39	1.2	0.5
ALT4532M-201	1.39	1.2	0.5

CIRCUIT DIAGRAM

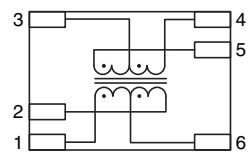

There is no directivity.

RECOMMENDED REFLOW PROFILE

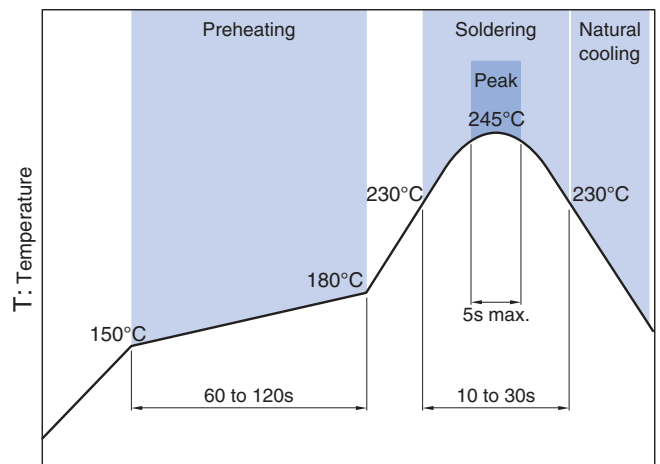

*When mounting the product, use our recommended reflow profile described above.

ALT3232M, ALT4532M type

PACKAGING STYLE

REEL DIMENSIONS

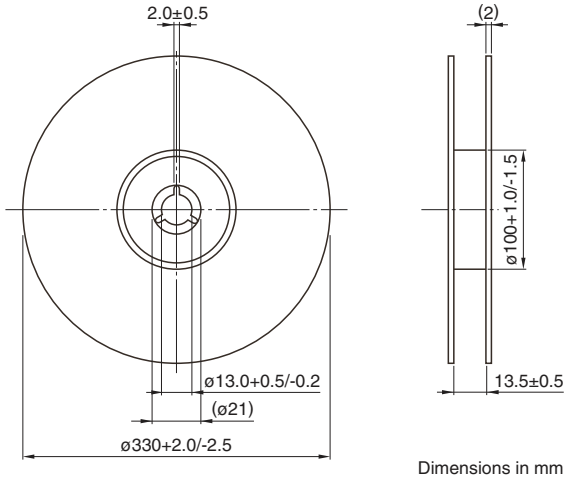

TAPE DIMENSIONS

ALT3232M

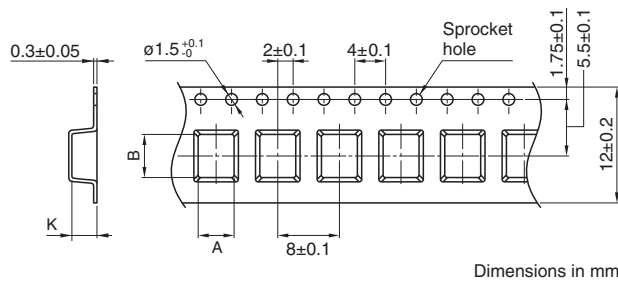

ALT4532M

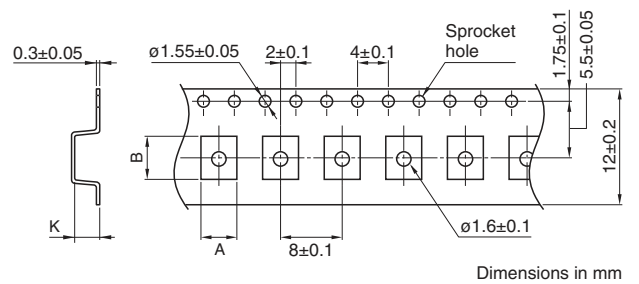

Type	A	B	K
ALT3232M	(3.55)	(3.55)	(3.0)
ALT4532M-171	(3.6)	(4.9)	(3.05)
ALT4532M-201	(3.6)	(4.9)	(3.05)

PACKAGE QUANTITY

Package quantity	2,000 pcs/reel
------------------	----------------

OPERATING TEMPERATURE RANGE, PRODUCT WEIGHT

Part No.	Temperature range		Individual weight (mg)
	Operating temperature* (°C)	Storage temperature** (°C)	
ALT3232M	-40 to +85	-40 to +85	120
ALT4532M-171	-40 to +85	-40 to +85	110
ALT4532M-201	-40 to +85	-40 to +85	160

* Operating temperature range includes self-temperature rise.

** The storage temperature range is for after the assembly.

REMINDERS FOR USING THESE PRODUCTS

Before using these products, be sure to request the delivery specifications.

SAFETY REMINDERS

Please pay sufficient attention to the warnings for safe designing when using this products.

REMINDERS

- The storage period is within 12 months. Be sure to follow the storage conditions (temperature: 5 to 40°C, humidity: 10 to 75% RH or less).
If the storage period elapses, the soldering of the terminal electrodes may deteriorate.
- Do not use or store in locations where there are conditions such as gas corrosion (salt, acid, alkali, etc.).
- Before soldering, be sure to preheat components.
The preheating temperature should be set so that the temperature difference between the solder temperature and chip temperature does not exceed 150°C.
- Soldering corrections after mounting should be within the range of the conditions determined in the specifications.
If overheated, a short circuit, performance deterioration, or lifespan shortening may occur.
- When embedding a printed circuit board where a chip is mounted to a set, be sure that residual stress is not given to the chip due to the overall distortion of the printed circuit board and partial distortion such as at screw tightening portions.
- Self heating (temperature increase) occurs when the power is turned ON, so the tolerance should be sufficient for the set thermal design.
- Carefully lay out the coil for the circuit board design of the non-magnetic shield type.
A malfunction may occur due to magnetic interference.
- Use a wrist band to discharge static electricity in your body through the grounding wire.
- Do not expose the products to magnets or magnetic fields.
- Do not use for a purpose outside of the contents regulated in the delivery specifications.
- The products listed on this catalog are intended for use in general electronic equipment (AV equipment, telecommunications equipment, home appliances, amusement equipment, computer equipment, personal equipment, office equipment, measurement equipment, industrial robots) under a normal operation and use condition.
The products are not designed or warranted to meet the requirements of the applications listed below, whose performance and/or quality require a more stringent level of safety or reliability, or whose failure, malfunction or trouble could cause serious damage to society, person or property.
If you intend to use the products in the applications listed below or if you have special requirements exceeding the range or conditions set forth in the each catalog, please contact us.

- (1) Aerospace/aviation equipment
- (2) Transportation equipment (cars, electric trains, ships, etc.)
- (3) Medical equipment
- (4) Power-generation control equipment
- (5) Atomic energy-related equipment
- (6) Seabed equipment
- (7) Transportation control equipment

- (8) Public information-processing equipment
- (9) Military equipment
- (10) Electric heating apparatus, burning equipment
- (11) Disaster prevention/crime prevention equipment
- (12) Safety equipment
- (13) Other applications that are not considered general-purpose applications

When designing your equipment even for general-purpose applications, you are kindly requested to take into consideration securing protection circuit/device or providing backup circuits in your equipment.