



Click boards™

A new idea is just a click away

Adding a new functionality to your design was never so easy. Sensors? Displays? Wireless transceivers? Motor control? Connection ports? Encoders? Or how about speech recognition, thunder detection, fingerprint scanning?

Pick from hundreds of Click boards™ — presented here in 1:1 scale — plug one into the mikroBUS™ socket and it's ready to work right away.

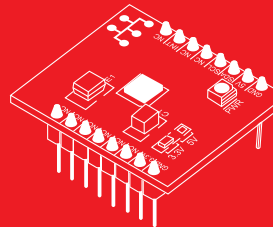
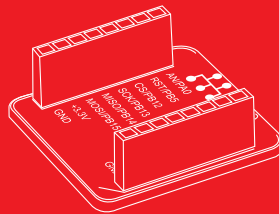

Click boards™

Ever-growing range of standardized add-on boards

WiFi, LoRa, BLE, GSM, GPS, OLED, speech recognition, environmental sensors, movement sensors, biosensors, LEDs, ADCs, relays - you name it, we got it. There are hundreds of Click boards available.



3G click (USA)

5V | 3.3V | SPI | I2C
UART | GPIO | PWM | AN

UG95 3G UMTS/HSPA module. With SIM card slot, Audio/Mic jack, micro USB port.

MSRP - \$89⁰⁰
MIKROE-2296



3G click (EU/AUS)

5Va | 3.3V | SPI | I2C
UART | GPIO | PWM | AN

UG95 3G UMTS/HSPA module. With SIM card slot, Audio/Mic jack, micro USB port.

MSRP - \$89⁰⁰
MIKROE-2226



3G SARA click

5V | 3.3V | SPI | I2C
UART | GPIO | PWM | AN

With UMTS/HSPA cellular modem – the u-blox U201, from the SARA series.

MSRP - \$99⁰⁰
MIKROE-2244



4G LTE click (EU)

5V | 3.3V | SPI | I2C
UART | GPIO | PWM | AN

It features the LARA-R211 multi-mode cellular module from u-blox.

MSRP - \$115⁰⁰
MIKROE-2527



4G LTE-NA click

5V | 3.3V | SPI | I2C
UART | GPIO | PWM | AN

It features the LARA-R204 multi-mode cellular module from u-blox.

MSRP - \$115⁰⁰
MIKROE-2535



6LoWPAN C click

5V | 3.3V | SPI | I2C

UART | GPIO | PWM | AN

TI's CC2520, 2.4GHz ZigBee®/IEEE 802.15.4 RF transceiver.

MSRP - \$26⁰⁰
MIKROE-2219



6LoWPAN T click

5V | 3.3V | SPI | I2C

UART | GPIO | PWM | AN

TI's CC2520, 2.4GHz ZigBee®/IEEE 802.15.4 RF transceiver.

MSRP - \$26⁰⁰
MIKROE-2218



BEE click

5V | 3.3V | SPI | I2C

UART | GPIO | PWM | AN

Microchip's MRF24J40MA 2.4 GHz IEEE 802.15.4 radio transceiver module.

MSRP - \$29⁰⁰
MIKROE-987



BLE 3 click

5V | 3.3V | SPI | I2C

UART | GPIO | PWM | AN

It features NINA-B1 Bluetooth 4.2 module from u-blox.

MSRP - \$39⁰⁰
MIKROE-2471



BLE 2 click

5V | 3.3V | SPI | I2C

UART | GPIO | PWM | AN

With RN4020 Bluetooth 4.1 module. Can be set up both as a client or a server.

MSRP - \$30⁰⁰
MIKROE-1715



BLE P click

5V | 3.3V | SPI | I2C
UART | GPIO | PWM | AN

With nRF8001 Bluetooth 4.0 peripheral device. Open source Android app available.

MSRP – \$25⁰⁰
MIKROE-1597



Bluetooth click

5V | 3.3V | SPI | I2C
UART | GPIO | PWM | AN

It features the RN-41 low power, class 1 Bluetooth radio module.

MSRP – \$39⁰⁰
MIKROE-958



BT Audio click

5V | 3.3V | SPI | I2C
UART | GPIO | PWM | AN

With RN52 Bluetooth audio module and on-board 3.5mm jacks for a mic and a speaker.

MSRP – \$49⁰⁰
MIKROE-2399



CC3100 click

5V | 3.3V | SPI | I2C
UART | GPIO | PWM | AN

Carries low power, high security Wi-Fi CC3100 module. Support for 802.11n.

MSRP – \$49⁰⁰
MIKROE-2336

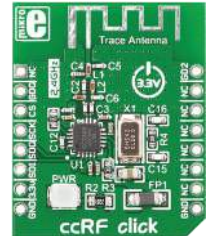

ccRF click

5V | 3.3V | SPI | I2C
UART | GPIO | PWM | AN

With CC2500 low-power 2.4 GHz RF transceiver and PCB trace antenna.

MSRP – \$22⁰⁰
MIKROE-1435



ccRF 2 click

5V 3.3V SPI I2C
 UART GPIO PWM AN

With CC1120, high performance radio transceiver for ISRM and SRD bands.

MSRP – \$36⁰⁰
 MIKROE-1716



EnOcean click

5V 3.3V SPI I2C
 UART GPIO PWM AN

With TCM 310 transceiver - bidirectional gateway for EnOcean's 868 MHz radio systems.

MSRP – \$39⁰⁰
 MIKROE-1908



EnOcean 2 click

5V 3.3V SPI I2C
 UART GPIO PWM AN

With TCM 515Z transceiver, based on the 2.4 GHz IEEE 802.15.4 radio standard.

MSRP – \$39⁰⁰
 MIKROE-2521



GNSS click

5V 3.3V SPI I2C
 UART GPIO PWM AN

Quectel's L86 GNSS module with a patch antenna and an external antenna connector.

MSRP – \$46⁰⁰
 MIKROE-1850



GNSS 2 click

5V 3.3V SPI I2C
 UART GPIO PWM AN

Quectel's L76 module and SMA antenna connector. GPS + GLONASS.

MSRP – \$39⁰⁰
 MIKROE-1887



GNSS 3 click

5V | 3.3V | SPI | I2C
UART | GPIO | PWM | AN

Carries SIM33ELAGNSS module with an integrated antenna and an external antenna connector.

MSRP – \$39⁰⁰
MIKROE-1895



GNSS 4 click

5V | 3.3V | SPI | I2C
UART | GPIO | PWM | AN

It features SAM-M8Q patch antenna module from u-blox.

MSRP – \$44⁰⁰
MIKROE-2045



GNSS 5 click

5V | 3.3V | SPI | I2C
UART | GPIO | PWM | AN

It features NEO-M8N GNSS receiver module from u-blox.

MSRP – \$41⁰⁰
MIKROE-2670



GPS click

5V | 3.3V | SPI | I2C
UART | GPIO | PWM | AN

It carries LEA-6S high-performance position engine from u-blox.

MSRP – \$49⁰⁰
MIKROE-1032

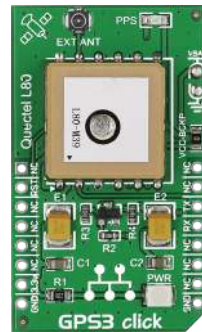

GPS 3 click

5V | 3.3V | SPI | I2C
UART | GPIO | PWM | AN

With Quectel's L80, high-sensitivity GPS module with a patch antenna.

MSRP – \$44⁰⁰
MIKROE-1714



GSM-GPS click

5V 3.3V SPI I2C

UART GPIO PWM AN

With SIM808, GSM/GPRS and GPS module. Two antenna connectors, SIM card slot, a micro USB connector.

MSRP - \$85⁰⁰
MIKROE-2382



GSM click

5V 3.3V SPI I2C

UART GPIO PWM AN

With quad-band GL865-QUAD GSM/ GPRS module, onboard antenna connector and SIM card socket.

MSRP - \$49⁰⁰
MIKROE-1298



GSM 2 click

5V 3.3V SPI I2C

UART GPIO PWM AN

With Quectel's M95 FA quad-band GSM/GPRS module. 85.6 kbps GPRS data transfer.

MSRP - \$44⁰⁰
MIKROE-1375



GSM 3 click

5V 3.3V SPI I2C

UART GPIO PWM AN

With SIM800H quad-band GSM/GPRS module. 85.6 kbps GPRS data transfer.

MSRP - \$57⁰⁰
MIKROE-1720



GSM/GNSS click

5V 3.3V SPI I2C

UART GPIO PWM AN

Quectel's MC60 quad-band GSM/GPRS/GNSS module. GPS/GNSS location tracking with GSM.

MSRP - \$79⁰⁰
MIKROE-2439



GSM/GNSS 2 click

5V 3.3V SPI I2C
UART GPIO PWM AN

With SIM868 quad-band GSM/GPRS module. GPS/GNSS location tracking with GSM.

MSRP - \$69⁰⁰
MIKROE-2440

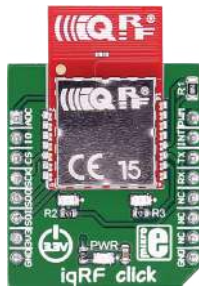

iQRF click

5V 3.3V SPI I2C
UART GPIO PWM AN

With DCTR-76DA RF transceiver, operating in the 868/916 MHz frequency.

MSRP - \$43⁰⁰
MIKROE-2586



iQRF 2 click

5V 3.3V SPI I2C
UART GPIO PWM AN

With DCTR-72DAT RF transceiver, operating in the 868/916 MHz frequency.

MSRP - \$49⁰⁰
MIKROE-2587

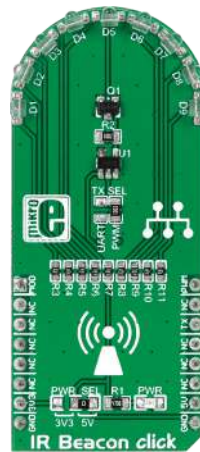

IR Beacon click

5V 3.3V SPI I2C
UART GPIO PWM AN

Functions as a beacon device with nine VSMB-2948SL high speed infrared emitting diodes.

MSRP - \$21⁰⁰
MIKROE-1939

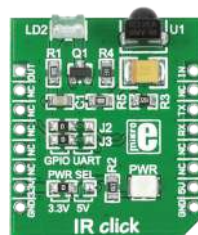

IR click

5V 3.3V SPI I2C
UART GPIO PWM AN

Features TSOP38338 IR 38 kHz receiver module as well as QEE113 IR emitting diode.

MSRP - \$9⁵⁰
MIKROE-1377



IrDA2 click

5V 3.3V SPI I2C
UART GPIO PWM AN

With TFDU4101 infrared transceiver module and MCP2120 infrared encoder/decoder.

MSRP - \$25⁰⁰
MIKROE-1195



LoRa RF click

5V 3.3V SPI I2C
UART GPIO PWM AN

With RN2483 LoRa Sub-GHz, 433/868 MHz European R&TTE Directive Assessed Radio Modem.

MSRP - \$54⁰⁰
MIKROE-1997



LoRa RF 2 Click

5V 3.3V SPI I2C
UART GPIO PWM AN

With RN2903 915 MHz Radio Modem compliant with regulations for use in the USA, CA, AU, NZ.

MSRP - \$54⁰⁰
MIKROE-2225



M-BUS RF click

5V 3.3V SPI I2C
UART GPIO PWM AN

With ME70-169 RF wireless module. Unlicensed ISM frequency band 169.400-169.475 MHz.

MSRP - \$54⁰⁰
MIKROE-2048



NFC click

5V 3.3V SPI I2C
UART GPIO PWM AN

With near field communications controller PN7120 IC from NXP.

MSRP - \$34⁰⁰
MIKROE-2395



NFC Tag 2 click

5V 3.3V SPI I2C
UART GPIO PWM AN

Carries NT3H1101 NTAG I2C energy harvesting NFC Forum Type 2 Tag from NXP.

MSRP – \$12⁰⁰
MIKROE-2462



NFC Tag click

5V 3.3V SPI I2C
UART GPIO PWM AN

With M24SR64 NFC/RFID tag IC with a dual interface and 8KB of high-reliability EEPROM built-in.

MSRP – \$12⁰⁰
MIKROE-1726



nRF C click

5V 3.3V SPI I2C
UART GPIO PWM AN

With nRF24L01P 2.4 GHz transceiver. Air data rates of 250 Kbps, 1 Mbps and 2 Mbps.

MSRP – \$19⁰⁰
MIKROE-1304



nRF S click

5V 3.3V SPI I2C
UART GPIO PWM AN

With nRF24L01P 2.4 GHz transceiver. 250 Kbps, 1 Mbps and 2 Mbps air data rates.

MSRP – \$19⁰⁰
MIKROE-1836



nRF T click

5V 3.3V SPI I2C
UART GPIO PWM AN

With nRF24L01P 2.4 GHz transceiver module. Air data rates of 250 Kbps, 1 Mbps and 2 Mbps.

MSRP – \$16⁰⁰
MIKROE-1305

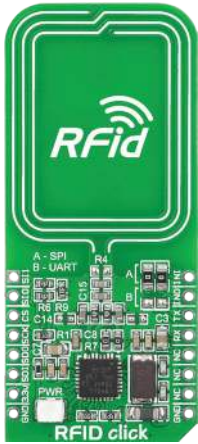

RFid click

5V 3.3V SPI I2C
UART GPIO PWM AN

With CR95HF 13.56 MHz contactless RFid transceiver, and trace antenna.

MSRP - \$29⁰⁰
MIKROE-1434

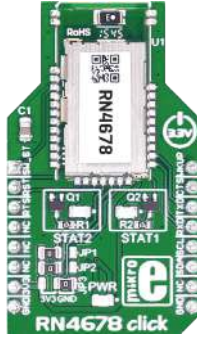

RN4678 click

5V 3.3V SPI I2C
UART GPIO PWM AN

It carries RN4678 Bluetooth® 4.2 dual mode module from Microchip.

MSRP - \$29⁰⁰
MIKROE-2545



RN4870 click

5V 3.3V SPI I2C
UART GPIO PWM AN

It carries RN4870 Bluetooth® 4.2 low energy module from Microchip.

MSRP - \$33⁰⁰
MIKROE-2543



RN4871 click

5V 3.3V SPI I2C
UART GPIO PWM AN

It carries RN4871 Bluetooth® 4.2 low energy module from Microchip.

MSRP - \$33⁰⁰
MIKROE-2544



SPIRIT click

5V 3.3V SPI I2C
UART GPIO PWM AN

With SP1M1 868MHz ultra low-power RF module. Memory: 16 kB RAM and 128 kB Flash.

MSRP - \$39⁰⁰
MIKROE-2568



tRF click

5V | 3.3V | SPI | I2C
UART | GPIO | PWM | AN

With Telit's LE70-868 — a 868 MHz transceiver module with embedded stack.

MSRP – \$59⁰⁰
MIKROE-1535

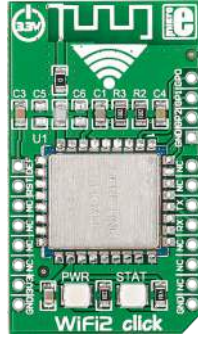

WiFi 2 click

5V | 3.3V | SPI | I2C
UART | GPIO | PWM | AN

With HLK-M30 module. Can be set up with either a static or dynamic IP address.

MSRP – \$29⁰⁰
MIKROE-1768



WiFi 3 click

5V | 3.3V | SPI | I2C
UART | GPIO | PWM | AN

With ESP8266 module. TCP/IP stack. Supports Wi-Fi Direct [p2p]. 6 GPIO pins.

MSRP – \$27⁰⁰
MIKROE-1769



WiFi 4 click

5V | 3.3V | SPI | I2C
UART | GPIO | PWM | AN

With SPWF01SA standalone WiFi module. Built-in 2.45 GHz ISM band antenna.

MSRP – \$49⁰⁰
MIKROE-1913



WiFi 5 click

5V | 3.3V | SPI | I2C
UART | GPIO | PWM | AN

With Gainspan's GS1500M 802.11b/g/n Low Power Wi-Fi module with a PCB trace antenna.

MSRP – \$29⁰⁰
MIKROE-2274

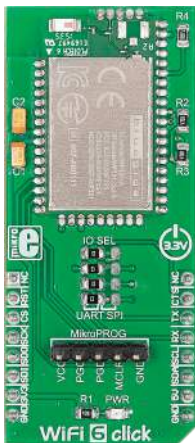

WiFi 6 Click

5V | 3.3V | SPI | I2C

UART | GPIO | PWM | AN

With WF121-A self-contained WiFi module. 2.4GHz band IEEE 802.11 b/g/n radio.

MSRP - \$69⁰⁰
MIKROE-2043



WiFi 7 click

5V | 3.3V | SPI | I2C

UART | GPIO | PWM | AN

With ATWINC1510-MR210PB IEEE 802.11 b/g/n module, 20MHz solution.

MSRP - \$29⁰⁰
MIKROE-2046



WiFi ESP click

5V | 3.3V | SPI | I2C

UART | GPIO | PWM | AN

With ESP-WROOM-02 module that integrates ESP8266EX. In AP WiFi and WiFi client mode.

MSRP - \$15⁰⁰
MIKROE-2542



WiFi PLUS click

5V | 3.3V | SPI | I2C

UART | GPIO | PWM | AN

With MRF24WB-OMA 2.4GHz, IEEE std. 802.11 module and MCW1001 controller.

MSRP - \$45⁰⁰
MIKROE-1135



WiFly click

5V | 3.3V | SPI | I2C

UART | GPIO | PWM | AN

With RN-131 embedded wireless LAN module. Qualified 2.4-GHz IEEE 802.11 b/g transceiver.

MSRP - \$69⁰⁰
MIKROE-1937



XBEE click

5V 3.3V SPI I2C
UART GPIO PWM AN

Xbee® and Zig-
bee-compliant XB-
24CZ7PIS-004 module
with a PCB antenna.

MSRP – \$59⁰⁰
MIKROE-1599



NANO GPS click

5V 3.3V SPI I2C
UART GPIO PWM AN

With Nano Hornet,
world's smallest GPS
module with an inte-
grated antenna.

MSRP – \$45⁰⁰
MIKROE-1912



AnyNet 2G click

5V 3.3V SPI I2C
UART GPIO PWM AN

WiFi module with
integrated IPv4 TCP/
IP stack and built-in
network protocols.

MSRP – \$69⁰⁰
MIKROE-2747



ccRF 3 click

5V 3.3V SPI I2C
UART GPIO PWM AN

Carries the CC1120
high-performance RF
transceiver for narrow-
band systems from TI.

MSRP – \$36⁰⁰
MIKROE-2389

Honey, I shrunk the GPS

Nano GPS click,
carrying the world's smallest GPS
module with an integrated antenna



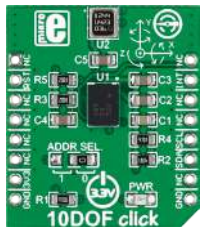

10DOF click

5V | 3.3V | SPI | I2C
 UART | GPIO | PWM | AN

With BNO055, a 9-axis absolute orientation sensor and BMP180, a digital pressure sensor.

MSRP – \$49⁰⁰
 MIKROE-2073

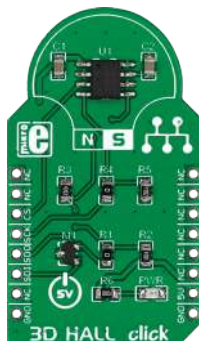

3D Hall Click

5V | 3.3V | SPI | I2C
 UART | GPIO | PWM | AN

With MLX90333 3-axis Hall sensor. Detects the position of any magnet in nearby space.

MSRP – \$25⁰⁰
 MIKROE-1987



3D Motion click

5V | 3.3V | SPI | I2C
 UART | GPIO | PWM | AN

MM7150 9-axis sensor fusion motion module and SSC7150 motion coprocessor.

MSRP – \$59⁰⁰
 MIKROE-1877

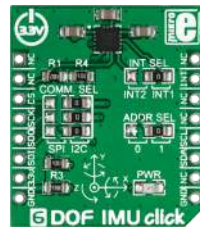

6DOF IMU click

5V | 3.3V | SPI | I2C
 UART | GPIO | PWM | AN

STM's LSM6DS33TR 6-axis IMU with 3-axis gyroscope and 3-axis accelerometer.

MSRP – \$49⁰⁰
 MIKROE-1298

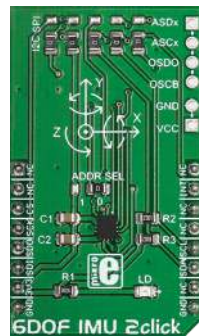

6DOF IMU 2 click

5V | 3.3V | SPI | I2C
 UART | GPIO | PWM | AN

With BMI160 low power IMU. For precise acceleration and gyroscopic measurement.

MSRP – \$24⁰⁰
 MIKROE-2337



9DOF click

5V 3.3V SPI I2C

UART GPIO PWM AN

LSM9DS1 inertial measurement module - 3D accelerometer, gyroscope and magnetometer.

MSRP - \$24⁰⁰
MIKROE-1941

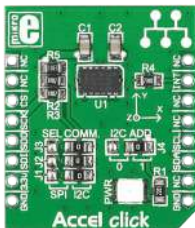

Accel click

5V 3.3V SPI I2C

UART GPIO PWM AN

With ADXL345 3-axis accelerometer. 13-bit measurement, embedded FIFO technologies.

MSRP - \$19⁰⁰
MIKROE-1194



Accel 2 click

5V 3.3V SPI I2C

UART GPIO PWM AN

LIS3DSH IC 3-axis accelerometer. Embedded FIFO buffer and 2 programmable state machines.

MSRP - \$19⁰⁰
MIKROE-1905

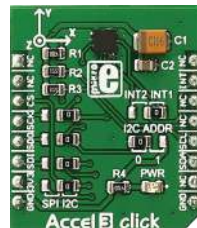

Accel 3 click

5V 3.3V SPI I2C

UART GPIO PWM AN

H3LIS331DL 3-axis linear accelerometer. Dynamically selectable scales $\pm 100g/\pm 200g/\pm 400g$.

MSRP - \$21⁰⁰
MIKROE-2102



Air quality click

5V 3.3V SPI I2C

UART GPIO PWM AN

MQ-135 sensor for detecting gases - ammonia, nitrogen oxides, benzene, smoke, CO2.

MSRP - \$16⁵⁰
MIKROE-1630



Air quality 2 click

5V 3.3V SPI I2C

UART GPIO PWM AN

iAQ-Core that measures VOC levels and provides CO2 equivalent and TVOC equivalent predictions.

MSRP – \$79⁰⁰
MIKROE-2529

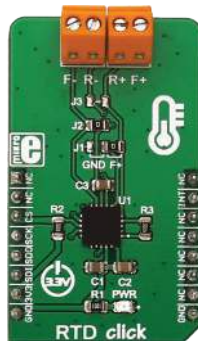

RTD click

5V 3.3V SPI I2C

UART GPIO PWM AN

It is based on MAX31865 resistance to digital converter optimized for RTDs.

MSRP – \$19⁰⁰
MIKROE-2815

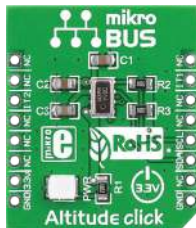

Altitude click

5V 3.3V SPI I2C

UART GPIO PWM AN

MEMS pressure sensor MPL3115A2. Pressure/altitude [20-bit] and temp. [12-bit] data.

MSRP – \$14⁵⁰
MIKROE-1489



Ambient click

5V 3.3V SPI I2C

UART GPIO PWM AN

With MLX75305 IC, CMOS integrated optical sensor. Converts ambient light intensity into voltage.

MSRP – \$9⁰⁰
MIKROE-1890

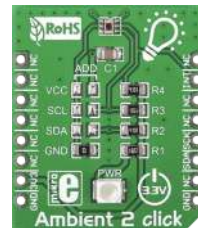

Ambient 2 click

5V 3.3V SPI I2C

UART GPIO PWM AN

TI's OPT3001 ambient light sensor. Measures the visible part of the light spectrum.

MSRP – \$14⁰⁰
MIKROE-1903



Angle 3 click

5V | 3.3V | SPI | I2C
 UART | GPIO | PWM | AN

With AK7451, a magnetic rotational angle sensor with 12-bit angle resolution.

MSRP – \$18⁰⁰
 MIKROE-2755

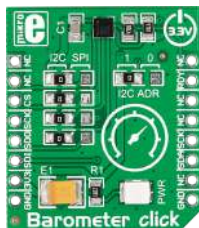

BAROMETER click

5V | 3.3V | SPI | I2C
 UART | GPIO | PWM | AN

LPS25HB IC, piezoresistive absolute pressure sensor. Range 260-1260 hPa.

MSRP – \$15⁰⁰
 MIKROE-1817

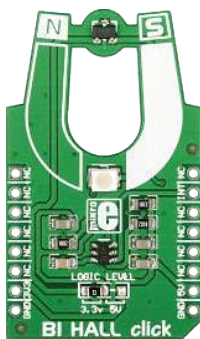

Bi Hall click

5V | 3.3V | SPI | I2C
 UART | GPIO | PWM | AN

US2882 bipolar Hall-effect switch and a 74LVC1T45 single bit, dual supply transceiver.

MSRP – \$12⁰⁰
 MIKROE-1646



CO click

5V | 3.3V | SPI | I2C
 UART | GPIO | PWM | AN

MQ-7 gas sensor with high sensitivity to carbon monoxide. Detection range 20ppm-2000ppm.

MSRP – \$16⁵⁰
 MIKROE-1626



Color click

5V | 3.3V | SPI | I2C
 UART | GPIO | PWM | AN

With TCS3471 [RGBC] color light sensor and a RGB LED diode. Resolution up to 16-bits.

MSRP – \$15⁰⁰
 MIKROE-1438

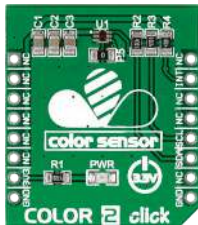

Color 2 click

5V | 3.3V | SPI | I2C
 UART | GPIO | PWM | AN

ISL29125 RGB color light sensor. 16-bit resolution data, measuring range 5.7 mlx-10,000 lux.

MSRP - \$16⁰⁰
 MIKROE-1988

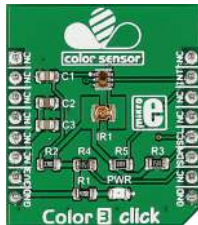

Color 3 click

5V | 3.3V | SPI | I2C
 UART | GPIO | PWM | AN

With TCS3771 color sensor and a narrow beam Infrared LED.

MSRP - \$17⁰⁰
 MIKROE-2103



Compass click

5V | 3.3V | SPI | I2C
 UART | GPIO | PWM | AN

It features LSM303DLHC ultra compact high performance e-compass module.

MSRP - \$25⁰⁰
 MIKROE-1386

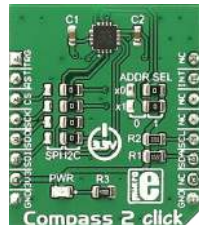

Compass 2 click

5V | 3.3V | SPI | I2C
 UART | GPIO | PWM | AN

With AK8963 3-axis electronic compass based on the Hall effect. 14-/16-bit selectable resolution.

MSRP - \$25⁰⁰
 MIKROE-2264

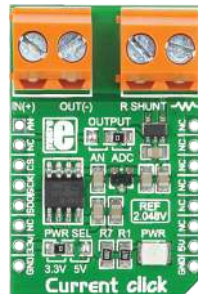

Current click

5V | 3.3V | SPI | I2C
 UART | GPIO | PWM | AN

With INA196 current shunt monitor, MCP3201 12-bit ADC, MAX6106 voltage reference.

MSRP - \$24⁰⁰
 MIKROE-1396

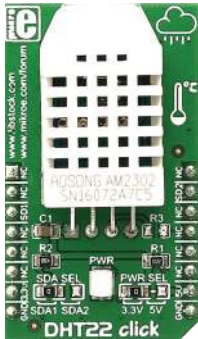

DHT22 click

5V 3.3V SPI I2C
UART GPIO PWM AN

With DHT22 temp. and humidity measurement sensor. Hum. 0–100%, temp. -40 to +80° C.

MSRP – \$24⁰⁰
MIKROE-1798



Diff pressure click

5V 3.3V SPI I2C
UART GPIO PWM AN

MPXV5010DP pressure sensor. Designed for comparing 2 pressure measurements.

MSRP – \$59⁰⁰
MIKROE-2387

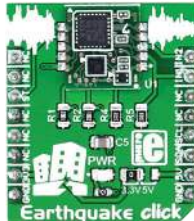

Earthquake click

5V 3.3V SPI I2C
UART GPIO PWM AN

It carries D7S, the world's smallest high-precision seismic sensor from Omron.

MSRP – \$69⁰⁰
MIKROE-2561

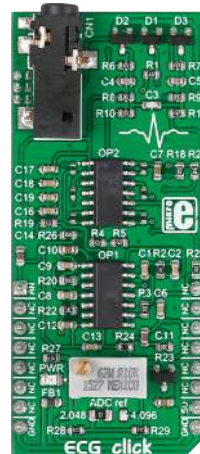

ECG click

5V 3.3V SPI I2C
UART GPIO PWM AN

It measures the electrical activity of a beating heart through electrodes taped to the skin.

MSRP – \$39⁰⁰
MIKROE-2455



ECG 2 click

5V 3.3V SPI I2C
UART GPIO PWM AN

Tracks the patterns of your beating heart. It carries ADS1194 16-bit delta-sigma ADC.

MSRP – \$49⁰⁰
MIKROE-2507



EMG click

5V 3.3V SPI I2C
UART GPIO PWM AN

Measures the electrical activity produced by the skeletal muscles.

MSRP - \$29⁰⁰
MIKROE-2621

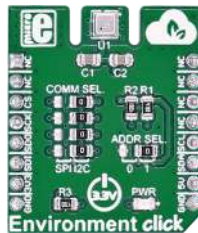

Environment click

5V 3.3V SPI I2C
UART GPIO PWM AN

Measures temperature, relative humidity, pressure and Volatile Organic compounds gases.

MSRP - \$34⁰⁰
MIKROE-2467

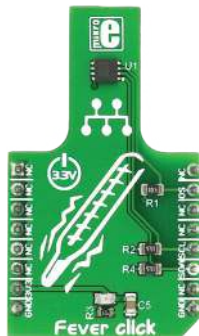

Fever click

5V 3.3V SPI I2C
UART GPIO PWM AN

Measures body temperature with MAX30205 sensor. Accuracy 0.1°C [37°C to 39°C].

MSRP - \$11⁰⁰
MIKROE-2554

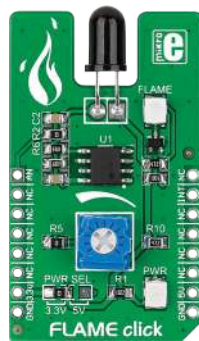

FLAME click

5V 3.3V SPI I2C
UART GPIO PWM AN

Used for fire detection. Carries PT334-6B silicon phototransistor sensitive only to infrared light.

MSRP - \$12⁰⁰
MIKROE-2060



Force click

5V 3.3V SPI I2C
UART GPIO PWM AN

With Interlink Electronics' Force Sensing Resistors. Force sensitivity range 0.2N-20N.

MSRP - \$25⁰⁰
MIKROE-2065

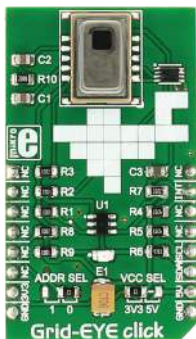

Grid-EYE click

5V 3.3V SPI I2C

UART GPIO PWM AN

8x8 thermal array sensor-detector that carries AMG8853 infrared array sensor.

MSRP – \$79⁰⁰
MIKROE-2539

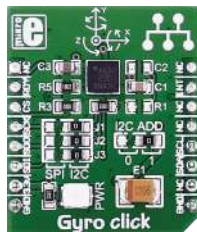

GYRO click

5V 3.3V SPI I2C

UART GPIO PWM AN

L3GD20 3-axis digital gyroscope module - can measure angular rate and ambient temperature.

MSRP – \$25⁰⁰
MIKROE-1379



Hall current click

5V 3.3V SPI I2C

UART GPIO PWM AN

High precision current sensor with TL14970-D050T4, a magnetic current sensor.

MSRP – \$34⁰⁰
MIKROE-1578

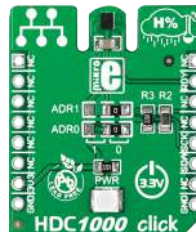

HDC1000 click

5V 3.3V SPI I2C

UART GPIO PWM AN

It's a humidity (and temperature) measurement click carrying the HDC1000 sensor.

MSRP – \$19⁰⁰
MIKROE-1797

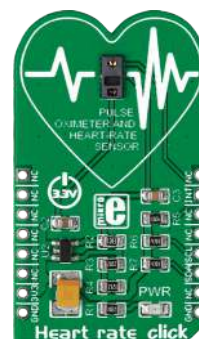

Heart rate click

5V 3.3V SPI I2C

UART GPIO PWM AN

With Maxim's MAX30100 integrated pulse oximetry and heart-rate sensor.

MSRP – \$19⁰⁰
MIKROE-2000

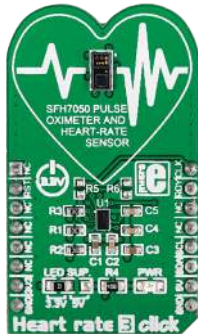

Heart rate 3 click

5V 3.3V SPI I2C

UART GPIO PWM AN

SFH7050 pulse oximetry and heart rate monitoring module, and AFE4404 IC for bio-sensing.

MSRP - \$39⁰⁰
MIKROE-2036

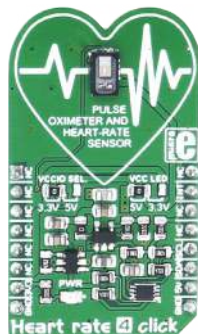

Heart rate 4 click

5V 3.3V SPI I2C

UART GPIO PWM AN

Carries the MAX30101 high-sensitivity pulse oximeter and heart-rate sensor.

MSRP - \$21⁰⁰
MIKROE-2510



HTU21D click

5V 3.3V SPI I2C

UART GPIO PWM AN

Carries a relative humidity sensor with temperature output. Rel. hum. 0-100%, temp. -40 to +125° C.

MSRP - \$21⁰⁰
MIKROE-1687



Hydrogen click

5V 3.3V SPI I2C

UART GPIO PWM AN

It carries MQ-8 sensor for hydrogen [H₂]. Sensor's detection range 100-10000ppm of H₂.

MSRP - \$15⁰⁰
MIKROE-1629

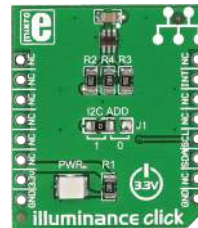

Illuminance click

5V 3.3V SPI I2C

UART GPIO PWM AN

With TSL2561 light-to-digital converter. Two photodiodes: full-spectrum and infrared light.

MSRP - \$16⁰⁰
MIKROE-1688

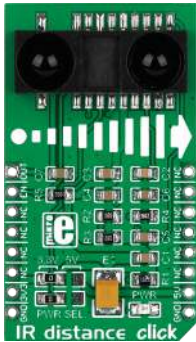

IR distance click

5V 3.3V SPI I2C

UART GPIO PWM AN

With GP2Y0A60SZ0F distance measuring sensor. Measuring range 10-150 cm.

MSRP – \$25⁰⁰
MIKROE-1991



IR eclipse click

5V 3.3V SPI I2C

UART GPIO PWM AN

With EE-SX198 photo interrupter sensor - detects anything that obstructs its beam.

MSRP – \$15⁰⁰
MIKROE-1711

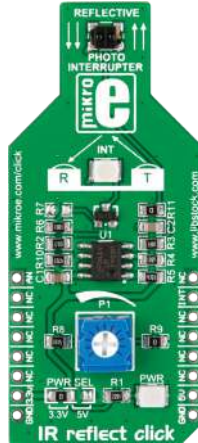

IR reflect click

5V 3.3V SPI I2C

UART GPIO PWM AN

Carries GP2S700HCP reflective photo interrupter and an onboard potentiometer.

MSRP – \$12⁰⁰
MIKROE-1882

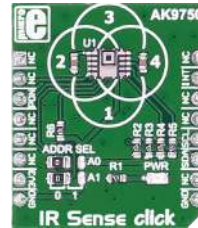

IR Sense click

5V 3.3V SPI I2C

UART GPIO PWM AN

With AK9750 quantum-type IR sensor. Detects the temperature of objects and people in motion.

MSRP – \$27⁰⁰
MIKROE-2677



IrThermo click 3.3V

5V 3.3V SPI I2C

UART GPIO PWM AN

With MLX90614ESF-BAA IR thermometer module, factory calibrated in wide temperature range.

MSRP – \$29⁰⁰
MIKROE-1361

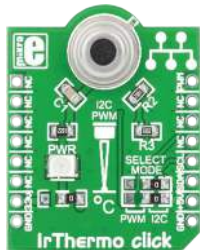
**IrThermo click 5V**

5V 3.3V SPI I2C
 UART GPIO PWM AN

With MLX90614ESF-AAA IR thermometer module, factory calibrated in wide temperature range.

MSRP – \$29⁰⁰
 MIKROE-1362

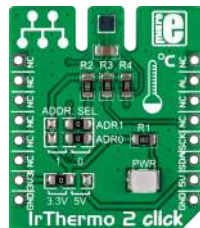
**IrThermo 2 click**

5V 3.3V SPI I2C
 UART GPIO PWM AN

It is a non-contact temperature measurement solution, with an infrared thermopile sensor.

MSRP – \$20⁰⁰
 MIKROE-1888

**LDC1000 click**

5V 3.3V SPI I2C
 UART GPIO PWM AN

With inductance-to-digital converter IC and a detachable sensor. For short range inductive sensing.

MSRP – \$35⁰⁰
 MIKROE-1583

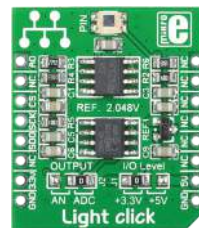
**Light click**

5V 3.3V SPI I2C
 UART GPIO PWM AN

Used to measure ambient light intensity, with PD15-22CTR8 PIN photodiode.

MSRP – \$18⁰⁰
 MIKROE-1424

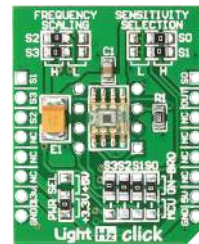
**LightHz click**

5V 3.3V SPI I2C
 UART GPIO PWM AN

With TSL230BR converter for conversion of light intensity to frequency with no external components.

MSRP – \$17⁹⁰
 MIKROE-990

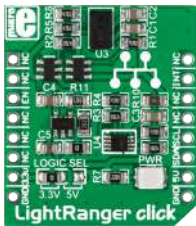

LightRanger click

5V 3.3V SPI I2C

UART GPIO PWM AN

It's a proximity sensor carrying VL6180X IC. Also works as an ambient light sensor.

MSRP – \$24⁰⁰
MIKROE-1897

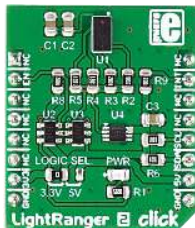

LightRanger 2 click

5V 3.3V SPI I2C

UART GPIO PWM AN

With VL53L0X IC, the world's smallest Time-of-Flight ranging and gesture detector sensor.

MSRP – \$24⁰⁰
MIKROE-2509

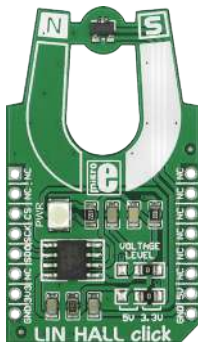

LIN HALL click

5V 3.3V SPI I2C

UART GPIO PWM AN

Carries MLX90242 linear Hall sensor IC. Measures magnet's strength and distance.

MSRP – \$17⁰⁰
MIKROE-1648

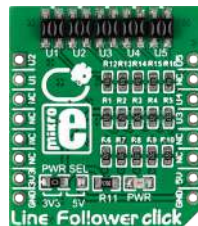

Line Follower click

5V 3.3V SPI I2C

UART GPIO PWM AN

With five QRE1113 miniature reflective object sensors. Used for line following robots and cars.

MSRP – \$15⁰⁰
MIKROE-1999



LPG click

5V 3.3V SPI I2C

UART GPIO PWM AN

With MQ-5 sensor for detecting liquefied petroleum gas leakage. Detection range 200-10000 ppm.

MSRP – \$15⁰⁰
MIKROE-1587

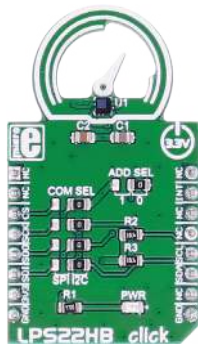

LPS22HB click

5V 3.3V SPI I2C
 UART GPIO PWM AN

Used as a digital barometer. It carries the LPS22HB MEMS nano pressure sensor.

MSRP – \$15⁰⁰
 MIKROE-2665

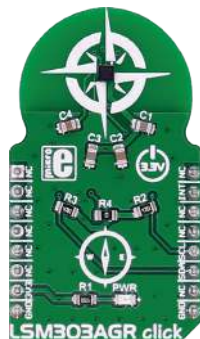

LSM303AGR click

5V 3.3V SPI I2C
 UART GPIO PWM AN

Measures acceleration and magnetic field characteristics. Carries LSM303AGR module.

MSRP – \$18⁰⁰
 MIKROE-2684

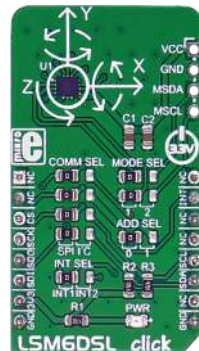

LSM6DSL click

5V 3.3V SPI I2C
 UART GPIO PWM AN

Measures linear and angular velocity with six degrees of freedom. Carries LSM6DSL module.

MSRP – \$15⁰⁰
 MIKROE-2731

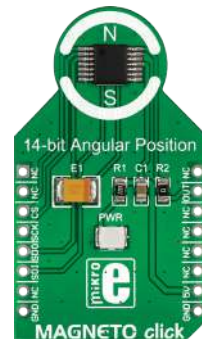

MAGNETO click

5V 3.3V SPI I2C
 UART GPIO PWM AN

Carries AS5048A contactless magnetic angle position sensor that relies on the Hall Effect.

MSRP – \$36⁰⁰
 MIKROE-1886



MAGNETO 2 click

5V 3.3V SPI I2C
 UART GPIO PWM AN

Enables the design of non-contacting rotary position sensors with MLX90316 sensor IC.

MSRP – \$29⁰⁰
 MIKROE-1938



Manometer click

5V 3.3V SPI I2C

UART GPIO PWM AN

Carries a piezoresistive silicon pressure sensor with extremely high accuracy ($\pm 0.25\%$ FSS BFSL).

MSRP - \$79⁰⁰
MIKROE-2237



Manometer 2 click

5V 3.3V SPI I2C

UART GPIO PWM AN

With MS5525D-SO-SB001GS digital pressure sensor. 24-bit digital pressure and temp. value.

MSRP - \$39⁰⁰
MIKROE-2550



Methane click

5V 3.3V SPI I2C

UART GPIO PWM AN

With MQ-4 sensor for methane [CH4]. Detection range 200-10000ppm of CH4.

MSRP - \$15⁰⁰
MIKROE-1628



MOTION click

5V 3.3V SPI I2C

UART GPIO PWM AN

It's a motion detector sensitive only to live bodies with PIR500B, a pyroelectric sensor.

MSRP - \$13⁰⁰
MIKROE-1589

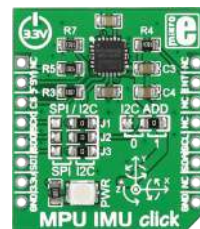

MPU IMU click

5V 3.3V SPI I2C

UART GPIO PWM AN

Carries MPU-6000 integrated 6-axis motion tracking device and a DMP [Digital Motion Processor].

MSRP - \$39⁰⁰
MIKROE-1577

Graceful movement. Quantified.

3D Motion click with 9-axis sensor fusion hub





MPU 9DOF Click

5V | 3.3V | SPI | I2C

UART | GPIO | PWM | AN

Carries the MPU-9150 system in package, the world's first 9-axis motion tracking device.

MSRP - \$42⁰⁰
MIKROE-1719



Ozone 2 click

5V | 3.3V | SPI | I2C

UART | GPIO | PWM | AN

With MQ131 sensor for Ozone [O3]. Detection range 10-1000 ppm of O3.

MSRP - \$37⁰⁰
MIKROE-2767



Pollution click

5V | 3.3V | SPI | I2C

UART | GPIO | PWM | AN

Detects organic gases - formaldehyde, benzene, alcohol, toluene, etc. Detection range 1x50ppm.

MSRP - \$49⁰⁰
MIKROE-2516

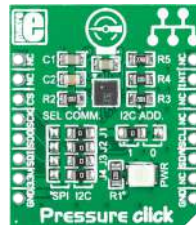

Pressure click

5V | 3.3V | SPI | I2C

UART | GPIO | PWM | AN

With LPS331AP digital output pressure sensor. For pressure [260-1260 mbar] and temp. [-40°C to 80°C].

MSRP - \$25⁰⁰
MIKROE-1422

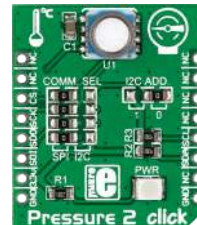

Pressure 2 click

5V | 3.3V | SPI | I2C

UART | GPIO | PWM | AN

With MS5803, a high resolution MEMS pressure sensor. Range 0-14 bars, resolution up to 0.2 mbars.

MSRP - \$69⁰⁰
MIKROE-1880

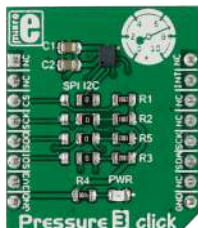

Pressure 3 click

5V 3.3V SPI I2C
 UART GPIO PWM AN

With DPS310 digital barometric pressure sensor. Range 300-1200 hPa.

MSRP - \$20⁰⁰
 MIKROE-2293



Proximity click

5V 3.3V SPI I2C
 UART GPIO PWM AN

With VCNL4010 proximity and ambient light sensor. Range up to 20cm, 16-bit resolution.

MSRP - \$17⁰⁰
 MIKROE-1445



Proximity 2 click

5V 3.3V SPI I2C
 UART GPIO PWM AN

With MAX44000, an IC that integrates an ambient light and a proximity sensor. Range 0.03-65.535 lux.

MSRP - \$19⁰⁰
 MIKROE-1818

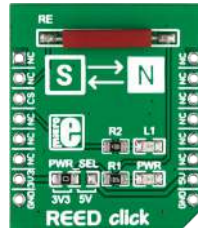

REED click

5V 3.3V SPI I2C
 UART GPIO PWM AN

With a standard reed switch. Used in mechanical systems as proximity sensors.

MSRP - \$7⁰⁰
 MIKROE-1998



RF Meter click

5V 3.3V SPI I2C
 UART GPIO PWM AN

It's an RF power measurement device. Frequency span 1 MHz-8 GHz, over 60 dB range.

MSRP - \$44⁰⁰
 MIKROE-2034

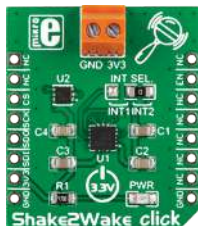

Shake2Wake click

5V 3.3V SPI I2C
 UART GPIO PWM AN

With ADXL362 ultralow power, 3-axis MEMS accelerometer. Includes several activity detection modes.

MSRP - \$39⁰⁰
 MIKROE-1942



SHT click

5V 3.3V SPI I2C
 UART GPIO PWM AN

Temperature and humidity sensor SHT3x-DIS. -0 to 100% RH, 40 to 125°C temp. range.

MSRP - \$26⁰⁰
 MIKROE-2101

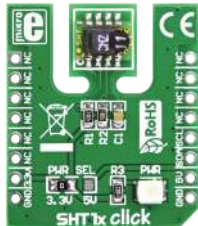

SHT1x click

5V 3.3V SPI I2C
 UART GPIO PWM AN

Digital humidity and temperature sensor SHT11. Not recommended for newer designs.

MSRP - \$13⁰⁰
 MIKROE-949



Smoke click

5V 3.3V SPI I2C
 UART GPIO PWM AN

With MAX30105 optical sensor for smoke detection. Sensor's inherent resolution 0.0625°C.

MSRP - \$19⁰⁰
 MIKROE-2560

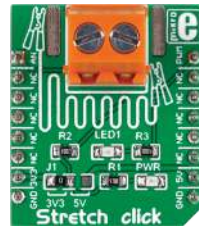

Stretch click

5V 3.3V SPI I2C
 UART GPIO PWM AN

Measures stretch forces with conductive rubber cord - 40-160 ohms per cm resistance.

MSRP - \$35⁰⁰
 MIKROE-2064

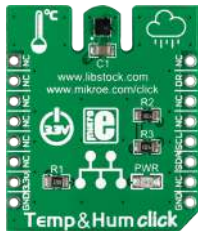

Temp&Hum click

5V 3.3V SPI I2C

UART GPIO PWM AN

With HTS221 temp. and relative humidity sensor. Measurement accuracy is $\pm 1^\circ\text{C}$ in $0\text{--}60^\circ\text{C}$ range.

MSRP – \$16⁰⁰
MIKROE-1971



THERMO click

5V 3.3V SPI I2C

UART GPIO PWM AN

With MAX31855K thermocouple-to-digital converter and PCC-SMP K-type thermocouple connector.

MSRP – \$29⁰⁰
MIKROE-1197

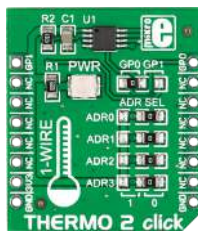

THERMO 2 click

5V 3.3V SPI I2C

UART GPIO PWM AN

With DS1825, a digital thermometer IC with a unique 64-bit address. -10°C to 85°C , $\pm 0.5^\circ\text{C}$ accuracy.

MSRP – \$15⁰⁰
MIKROE-1840

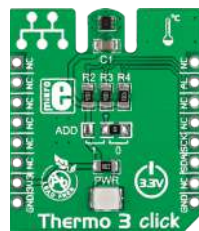

Thermo 3 click

5V 3.3V SPI I2C

UART GPIO PWM AN

With TMP102, a digital temp. sensor IC. Accurate within 0.5°C . Range from -25°C to 85°C .

MSRP – \$9⁰⁰
MIKROE-1885

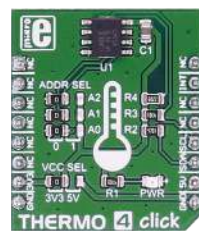

THERMO 4 click

5V 3.3V SPI I2C

UART GPIO PWM AN

It carries digital temperature sensor and thermal watchdog. Range from -55°C to $+125^\circ\text{C}$.

MSRP – \$9⁰⁰
MIKROE-2632



THERMO 5 click

5V 3.3V SPI I2C

UART GPIO PWM AN

Measures temperature in default range of 0°C to 127°C and extended range of -64°C to 191°C.

MSRP - \$11⁰⁰
MIKROE-2571

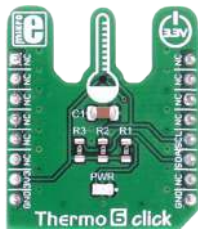

Thermo 6 click

5V 3.3V SPI I2C

UART GPIO PWM AN

Ambient temp. measurement device, based on the MAX31875 temp. sensor.

MSRP - \$9⁰⁰
MIKROE-2769



THERMO K click

5V 3.3V SPI I2C

UART GPIO PWM AN

It carries the MCP9600 IC. It can measure temperatures from -200 °C to +1372 °C.

MSRP - \$24⁰⁰
MIKROE-2501



Thermostat click

5V 3.3V SPI I2C

UART GPIO PWM AN

It carries MAX7502 IC that can measure temp. from -25°C to +100°C. Accuracy ±1.5°C.

MSRP - \$19⁰⁰
MIKROE-2273



Thunder click

5V 3.3V SPI I2C

UART GPIO PWM AN

Detects the presence and proximity of lightning activity with AS3935 lightning sensor.

MSRP - \$35⁰⁰
MIKROE-1444

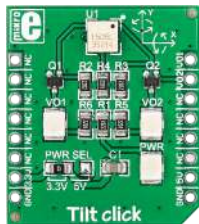

Tilt click

5V 3.3V SPI I2C
 UART GPIO PWM AN

With RPI-1035, a 4-directional optical tilt sensor - left, right, backward, forward movement.

MSRP - \$12⁹⁰
 MIKROE-1834

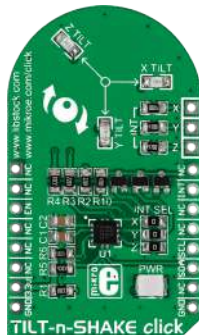

TILTnSHAKE click

5V 3.3V SPI I2C
 UART GPIO PWM AN

With MMA8491Q IC, a 3-axis digital accelerometer. Can function as a 45 ° tilt sensor.

MSRP - \$19⁰⁰
 MIKROE-1853

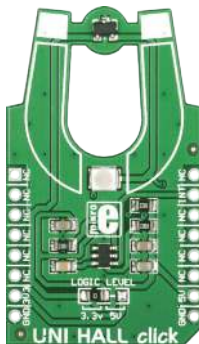

UNI HALL click

5V 3.3V SPI I2C
 UART GPIO PWM AN

With US5881 unipolar Hall-effect switch sensitive to the North Pole magnetic fields.

MSRP - \$12⁰⁰
 MIKROE-1647

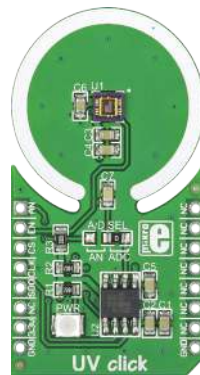

UV click

5V 3.3V SPI I2C
 UART GPIO PWM AN

With ML8511 IC that is sensitive to UVA and UVB rays. Outputs either analog or digital signals.

MSRP - \$24⁰⁰
 MIKROE-1677

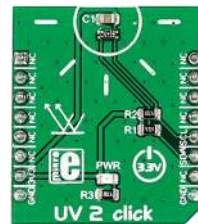

UV 2 click

5V 3.3V SPI I2C
 UART GPIO PWM AN

Carries VEML6075 UVA and UVB light sensor. With a photodiode, amplifiers, analog/digital circuits.

MSRP - \$19⁰⁰
 MIKROE-2378

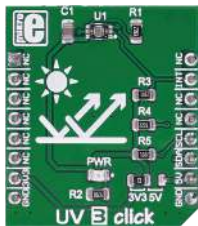

UV 3 click

5V 3.3V SPI I2C

UART GPIO PWM AN

An advanced ultraviolet (UV) light sensor with VEML6070 UVA light sensor.

MSRP - \$9⁰⁰
MIKROE-2736



Vibra sense click

5V 3.3V SPI I2C

UART GPIO PWM AN

A micro shock vibration sensor with a digital output. For anti-tampering, anti-theft devices.

MSRP - \$18⁰⁰
MIKROE-1927

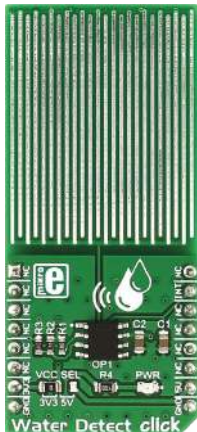

Water Detect click

5V 3.3V SPI I2C

UART GPIO PWM AN

For detecting water and other electroconductive liquids. Carries Microchip's MCP606.

MSRP - \$9⁰⁰
MIKROE-2786



Weather click

5V 3.3V SPI I2C

UART GPIO PWM AN

With BME280 integrated environmental unit. Detects humidity, pressure, and temperature.

MSRP - \$22⁰⁰
MIKROE-1978

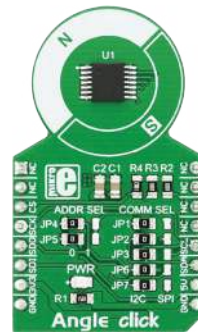

Angle click

5V 3.3V SPI I2C

UART GPIO PWM AN

Hall-effect angle sensing device used to measure the rotational angle of the magnetic field.

MSRP - \$16⁰⁰
MIKROE-2030



Thermo J click

5V 3.3V SPI I2C

UART GPIO PWM AN

It is a temperature measurement click board™, which uses a thermocouple type-J probe.

MSRP – \$24⁰⁰
MIKROE-2811

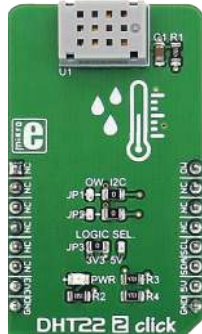

DHT22 2 click

5V 3.3V SPI I2C

UART GPIO PWM AN

It is used for measuring the environmental temperature and relative humidity.

MSRP – \$22⁰⁰
MIKROE-2818



IrDA 3 click

5V 3.3V SPI I2C

UART GPIO PWM AN

Intelligent IR transceiver device that sends and receives UART commands via the IR interface.

MSRP – \$26⁰⁰
MIKROE-2871

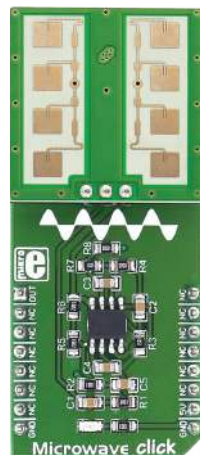

Microwave click

5V 3.3V SPI I2C

UART GPIO PWM AN

It detects movement, thanks to the PD-V11 a 24GHz microwave motion sensor.

MSRP – \$25⁰⁰
MIKROE-2781



Proximity 3 click

5V 3.3V SPI I2C

UART GPIO PWM AN

Intelligent proximity and light sensing device – high sensitivity long distance PS and ALS.

MSRP – \$17⁰⁰
MIKROE-2801



Alcohol click

5V 3.3V SPI I2C
UART GPIO PWM AN

Detects alcohol in concentrations from 0.04 to 4mg/l with MQ-3 Semiconductor sensor.

MSRP - \$15⁰⁰
MIKROE-1586

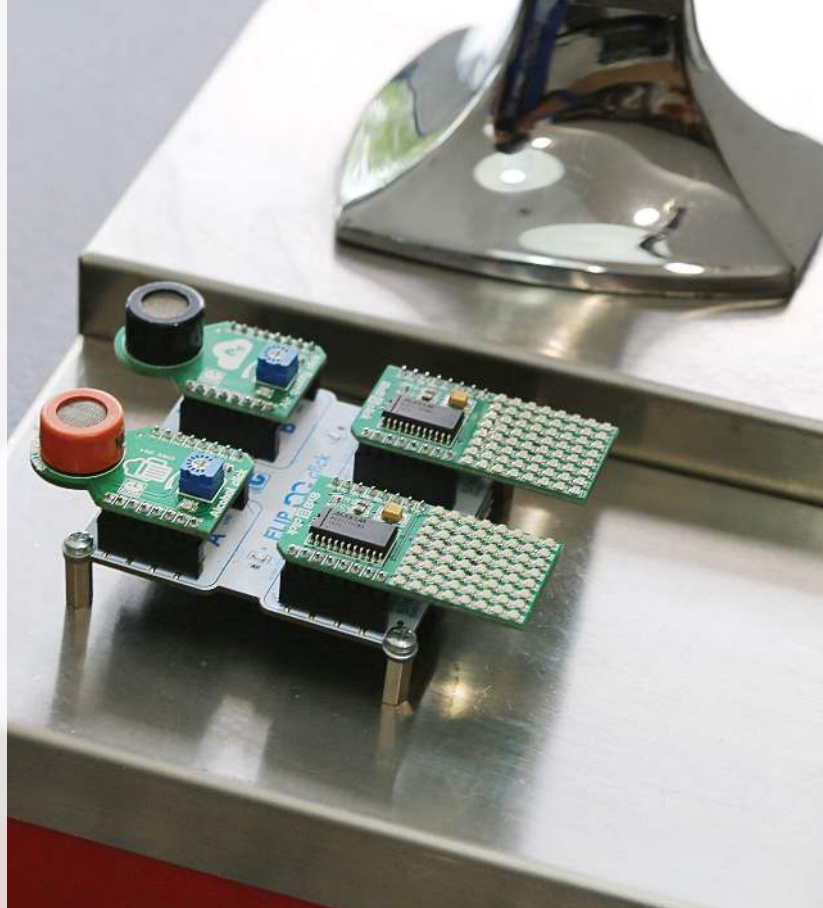

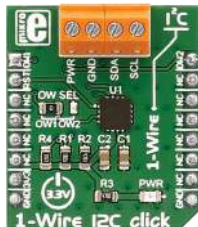

1-Wire I2C click

5V | 3.3V | SPI | I2C
 UART | GPIO | PWM | AN

Converts I2C to 1-wire with DS28E17 1-Wire-to-I2C master bridge from Maxim Integrated.

MSRP – \$22⁰⁰
 MIKROE-2750



4-20 mA R click

5V | 3.3V | SPI | I2C
 UART | GPIO | PWM | AN

Serves as a receiver in a 4-20mA current loop standard. Converts it into a voltage [0.4-2V].

MSRP – \$26⁰⁰
 MIKROE-1387



4-20 mA T click

5V | 3.3V | SPI | I2C
 UART | GPIO | PWM | AN

Easy solution for adding 4-to-20mA industry standard communication protocol to your design.

MSRP – \$26⁰⁰
 MIKROE-1296

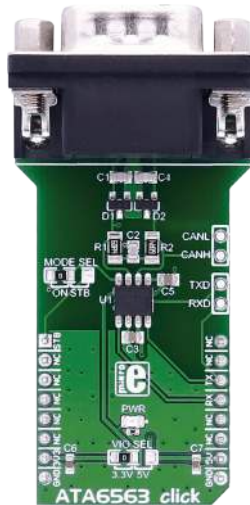

ATA6563 click

5V | 3.3V | SPI | I2C
 UART | GPIO | PWM | AN

Microchip's ATA6563 high-speed CAN transceiver for Classical CAN and CAN FD networks.

MSRP – \$20⁰⁰
 MIKROE-2334



ATA663211 click

5V | 3.3V | SPI | I2C
 UART | GPIO | PWM | AN

LIN transceiver IC designed to handle low-speed data communication in applications.

MSRP – \$19⁰⁰
 MIKROE-2335

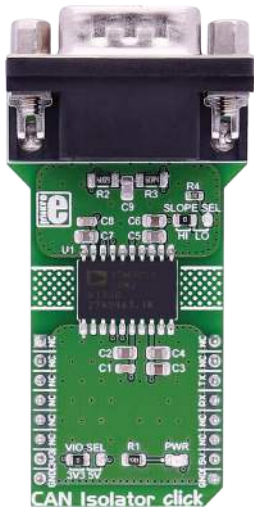

CAN Isolator click

5V | 3.3V | SPI | I2C

UART | GPIO | PWM | AN

Provides isolated CAN communication. Data rates of up to 1 Mbps. Carries a DB 9-pin male connector.

MSRP - \$39⁰⁰
MIKROE-2627



CAN SPI click 3.3V

5V | 3.3V | SPI | I2C

UART | GPIO | PWM | AN

Adds CAN connectivity with SPI interface. Features SN65HVD230 CAN transceiver circuit.

MSRP - \$21⁰⁰
MIKROE-986



CAN SPI click 5V

5V | 3.3V | SPI | I2C

UART | GPIO | PWM | AN

Adds CAN connectivity with SPI interface. With MCP2551 CAN transceiver circuit.

MSRP - \$21⁰⁰
MIKROE-988

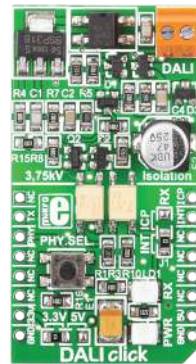

DALI Click

5V | 3.3V | SPI | I2C

UART | GPIO | PWM | AN

Provides Digital Lighting Interface. With two optocouplers, push button, screw terminal.

MSRP - \$25⁰⁰
MIKROE-1297



ETH Click

5V | 3.3V | SPI | I2C

UART | GPIO | PWM | AN

With ENC28J60, a 28-pin, 10BASE-T stand-alone Ethernet controller with an on-board MAC & PHY.

MSRP - \$24⁰⁰
MIKROE-971



ETH WIZ click

5V 3.3V SPI I2C
 UART GPIO PWM AN

With W5500, a 48-pin, 10/100 BASE-TX stand-alone Ethernet controller. Standard RJ-45 connector.

MSRP – \$19⁰⁰
 MIKROE-1718



EXPAND click

5V 3.3V SPI I2C
 UART GPIO PWM AN

Expands the number of input-output lines with Microchip's 16-bit I/O expander MCP23S17.

MSRP – \$12⁰⁰
 MIKROE-951

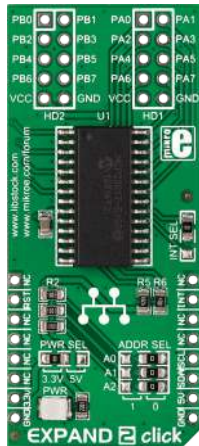

Expand 2 click

5V 3.3V SPI I2C
 UART GPIO PWM AN

Expands the number of input-output lines with Microchip's 16-bit I/O expander MCP23017.

MSRP – \$12⁰⁰
 MIKROE-1838

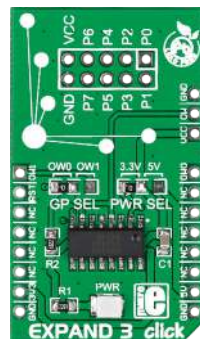

Expand 3 click

5V 3.3V SPI I2C
 UART GPIO PWM AN

With DS2408, an 8-channel programmable I/O expander from Maxim Integrated.

MSRP – \$19⁰⁰
 MIKROE-1874



EXPAND 4 click

5V 3.3V SPI I2C
 UART GPIO PWM AN

Port expander for high power peripherals with TPCIC6A595 power logic 8-bit register.

MSRP – \$14⁰⁰
 MIKROE-1910

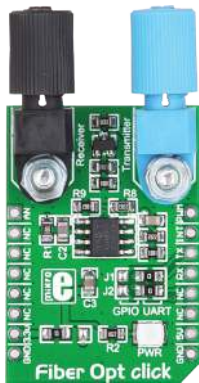

Fiber Opt click

5V 3.3V SPI I2C
UART GPIO PWM AN

Adds fiber-optic communication with IF-D91 fiber-optic photodiode, IF-E97 fiber-optic LED diode.

MSRP - \$34⁰⁰
MIKROE-1940



FTDI click

5V 3.3V SPI I2C
UART GPIO PWM AN

With FT232HL - dual high speed USB 2.0 to UART/I2C/SPI serial interface converter.

MSRP - \$29⁰⁰
MIKROE-1421

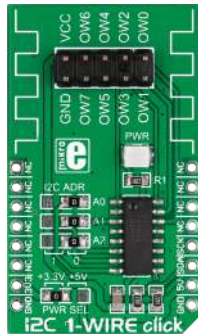

I2C 1-Wire click

5V 3.3V SPI I2C
UART GPIO PWM AN

Performs bidirectional conversions between I2C masters and 1-Wire slave devices with DS2482-800.

MSRP - \$28⁰⁰
MIKROE-1892



I2C Isolator click

5V 3.3V SPI I2C
UART GPIO PWM AN

TI's ISO1540, a low-power, bidirectional isolator compatible with I2C interfaces.

MSRP - \$18⁰⁰
MIKROE-1878

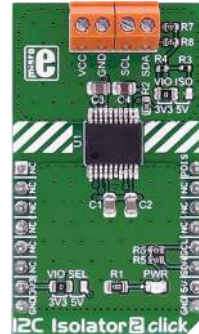

I2C Isolator 2 click

5V 3.3V SPI I2C
UART GPIO PWM AN

Provides I2C lines and power isolation for slave devices with ADM3260 dual I2C isolator.

MSRP - \$24⁰⁰
MIKROE-2609

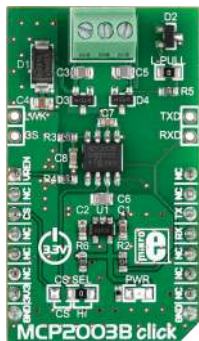

MCP2003B click

5V | 3.3V | SPI | I2C
 UART | GPIO | PWM | AN

It's a physical interface to automotive and industrial LIN systems with a bi-directional LIN transceiver.

MSRP - \$18⁰⁰
 MIKROE-2227

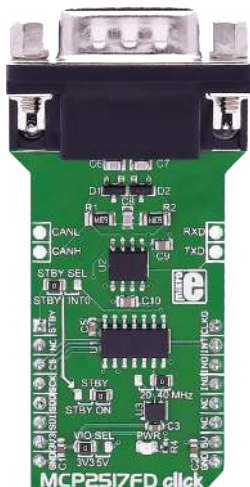

MCP2517FD click

5V | t | SPI | I2C
 UART | GPIO | PWM | AN

With MCP2517FD CAN FD controller and ATA6563 high-speed CAN transceiver.

MSRP - \$25⁰⁰
 MIKROE-2379

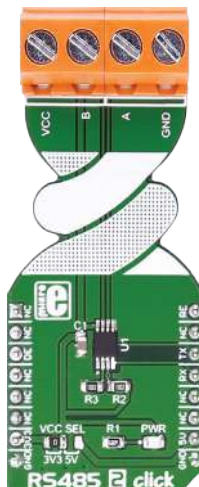

RS485 2 click

5V | 3.3V | SPI | I2C
 UART | GPIO | PWM | AN

Carries MAX3471 half-duplex transceiver for lithium battery-powered RS-485/RS-422 applications.

MSRP - \$18⁰⁰
 MIKROE-2700

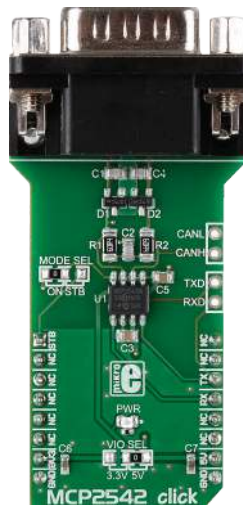

MCP2542 click

5V | 3.3V | SPI | I2C
 UART | GPIO | PWM | AN

Microchip's CAN FD Transceiver with Wake-Up Pattern. Compliant with CAN 2.0 and CAN FD.

MSRP - \$20⁰⁰
 MIKROE-2299

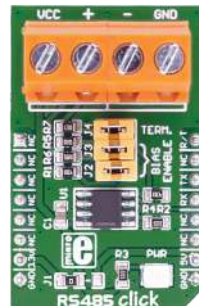

RS485 click 3.3V

5V | 3.3V | SPI | I2C
 UART | GPIO | PWM | AN

Carries SN-65HVD12 half-duplex, RS-485 transceiver from Texas Instruments.

MSRP - \$18⁰⁰
 MIKROE-989



MCP25625 click

5V 3.3V SPI I2C
UART GPIO PWM AN

With CAN controller with an integrated transceiver. High speed operation up to 1 Mb/s.

MSRP – \$24⁰⁰
MIKROE-2228



RS485 click 5V

5V 3.3V SPI I2C
UART GPIO PWM AN

Carries the ADM485 differential line transceiver from Analog Devices.

MSRP – \$18⁰⁰
MIKROE-925



PS/2 click

5V 3.3V SPI I2C
UART GPIO PWM AN

Adds keyboard and mouse connectivity. With a standard 6-pin Mini-DIN PS/2 connector.

MSRP – \$9⁰⁰
MIKROE-1576

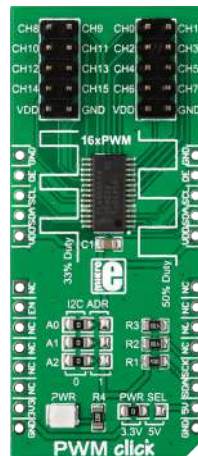

PWM click

5V 3.3V SPI I2C
UART GPIO PWM AN

For controlling 16 PWM outputs through a single I2C interface. With PCA9685PW IC.

MSRP – \$14⁹⁰
MIKROE-1898

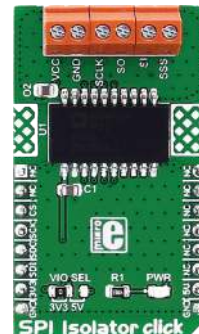

SPI Isolator click

5V 3.3V SPI I2C
UART GPIO PWM AN

Carries ADuM4154 5kV digital isolator optimized for a serial peripheral interface [SPI].

MSRP – \$29⁰⁰
MIKROE-2583

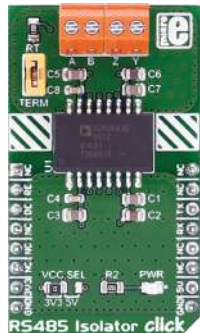

RS485 Isolator click

5V 3.3V SPI I2C
UART GPIO PWM AN

With ADM2682EBRIZ, a 5 kV RMS signal and power isolated RS-485 transceiver.

MSRP - \$49⁰⁰
MIKROE-2673

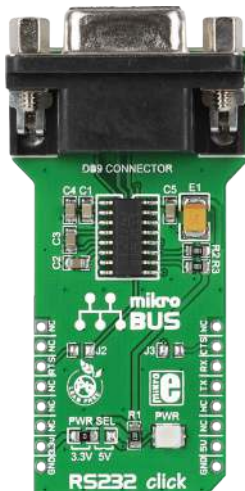

RS232 click

5V 3.3V SPI I2C
UART GPIO PWM AN

Adds RS232 connectivity with a standard RS232 DB9 port and a MAX3232 IC.

MSRP - \$15⁰⁰
MIKROE-1582



USB I2C click

5V 3.3V SPI I2C
UART GPIO PWM AN

With MCP2221 USB-to-UART/I2C converter. Full-speed USB [12 Mb/s], I2C up to 400 kHz clock rates.

MSRP - \$13⁹⁰
MIKROE-1985



USB SPI click

5V 3.3V SPI I2C
UART GPIO PWM AN

Microchip's MCP2210 USB-to-SPI protocol converter with GPIO as well as USB MINI B connector.

MSRP - \$13⁹⁰
MIKROE-1204



USB UART 2 click

5V 3.3V SPI I2C
UART GPIO PWM AN

Provides USB isolation and carries the AD-UM4160BRWZ USB port isolator.

MSRP - \$39⁰⁰
MIKROE-2674



USB UART click

5V 3.3V SPI I2C
UART GPIO PWM AN

Adds serial UART communication via USB cable. With FT232RL USB-to-UART interface module.

MSRP - \$13⁹⁰
MIKROE-1203



ATA663254 click

5V 3.3V SPI I2C
UART GPIO PWM AN

It is a fully integrated LIN transceiver device with an integrated 5V LDO voltage regulator.

MSRP - \$16⁰⁰
MIKROE-2872



BroadR-Reach click

5V 3.3V SPI I2C
UART GPIO PWM AN

For realizing network in harsh environments that require reliable Ethernet-based open network.

MSRP - \$69⁰⁰
MIKROE-2796

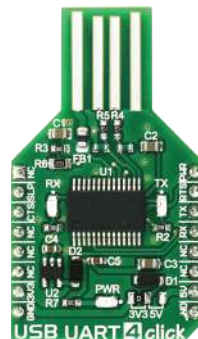

USB UART 4 click

5V 3.3V SPI I2C
UART GPIO PWM AN

USB to asynchronous serial data transfer interface. With FT232RL, USB-to-UART interface module.

MSRP - \$13⁹⁰
MIKROE-2810

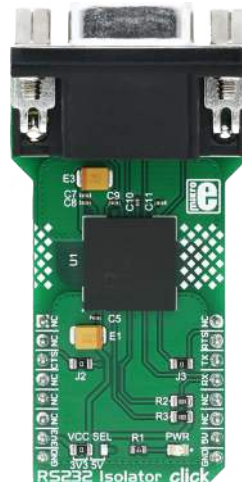

RS232 Isolator click

5V 3.3V SPI I2C
UART GPIO PWM AN

Isolated dual transceiver click - secure and easy UART to RS232 conversion, with galvanic isolation.

MSRP - \$56⁰⁰
MIKROE-2864

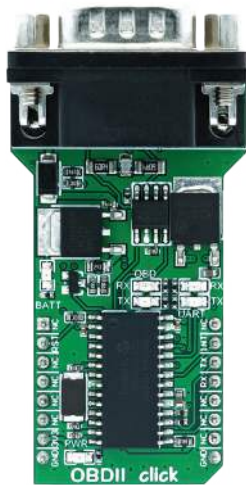

OBDII click

5V 3.3V SPI I2C
 UART GPIO PWM AN

Tap inside the car diagnostic systems! Features the STN1110 Multiprotocol OBD to UART Interface.

MSRP - \$47⁹⁰
 MIKROE-2452



RS485 3 click

5V 3.3V SPI I2C
 UART GPIO PWM AN

The click is intended to be used as UART to RS422/RS485 communication interface.

MSRP - \$20⁰⁰
 MIKROE-2821



16x12 G click

5V 3.3V SPI I2C

UART GPIO PWM AN

Carries a 16x12 LED display and the IS-31FL3733 matrix driver with 1/12 cycle rate.

MSRP – \$30⁰⁰
MIKROE-2758



16x9 G click

5V 3.3V SPI I2C

UART GPIO PWM AN

With a green 16x9 LED matrix and IS31FL3731 audio modulated matrix LED driver.

MSRP – \$34⁰⁰
MIKROE-2520



4Dot-Matrix R click

5V 3.3V SPI I2C

UART GPIO PWM AN

Displays 4 char. of 5x7 dot size. With SL02016 module and MCP23017 I2C port expander.

MSRP – \$59⁰⁰
MIKROE-2706

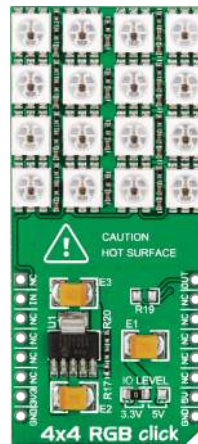

4x4 RGB click

5V 3.3V SPI I2C

UART GPIO PWM AN

With a matrix of 16 WS2812 RGB LEDs a MCP1826 low dropout regulator.

MSRP – \$19⁰⁰
MIKROE-1881

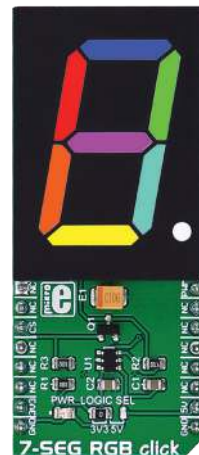

7-SEG RGB click

5V 3.3V SPI I2C

UART GPIO PWM AN

Carries a full color single 7 segment digit display. 16,581,375 color combinations.

MSRP – \$29⁰⁰
MIKROE-2734

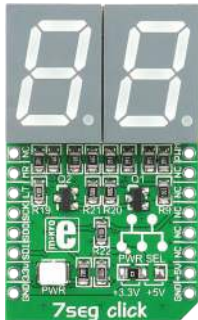

7seg click

5V 3.3V SPI I2C
UART GPIO PWM AN

2-digit seven-seg display.
With two 74HC595 8-bit
serial-in, parallel-out
shift registers.

MSRP – \$10⁰⁰
MIKROE-1201

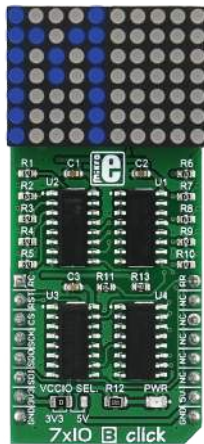

7x10 B click

5V 3.3V SPI I2C
UART GPIO PWM AN

With a matrix of 70 blue
LEDs driven by a pair of
8-bit serial-in, paral-
lel-out shift registers.

MSRP – \$15⁰⁰
MIKROE-2769

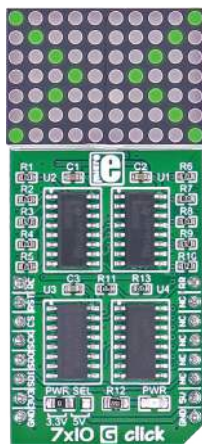

7x10 G click

5V 3.3V SPI I2C
UART GPIO PWM AN

With a matrix of 70 green
LEDs driven by a pair of
8-bit serial-in, paral-
lel-out shift registers.

MSRP – \$15⁰⁰
MIKROE-2705

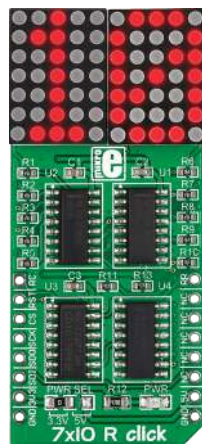

7x10 R click

5V 3.3V SPI I2C
UART GPIO PWM AN

With a matrix of 70 red
LEDs driven by a pair of
8-bit serial-in, paral-
lel-out shift registers.

MSRP – \$15⁰⁰
MIKROE-1993

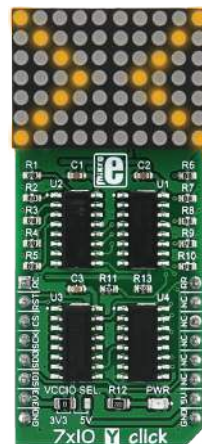

7x10 Y click

5V 3.3V SPI I2C
UART GPIO PWM AN

With a matrix of 70 yellow
LEDs driven by a pair of
8-bit serial-in, paral-
lel-out shift registers.

MSRP – \$15⁰⁰
MIKROE-2790

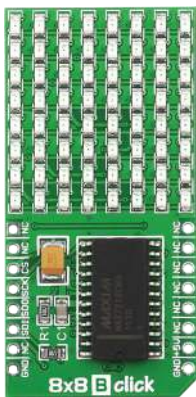

8x8 B click

5V 3.3V SPI I2C
UART GPIO PWM AN

It features MAX7219 8-digit LED display driver module as well as 64 BLUE LEDs.

MSRP - \$18⁰⁰
MIKROE-1307

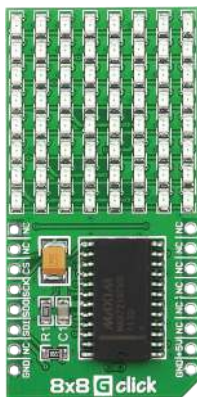

8x8 G click

5V 3.3V SPI I2C
UART GPIO PWM AN

It features MAX7219 8-digit LED display driver module as well as 64 GREEN LEDs.

MSRP - \$15⁰⁰
MIKROE-1306

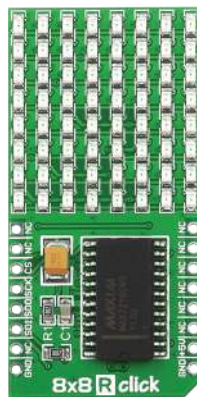

8x8 R click

5V 3.3V SPI I2C
UART GPIO PWM AN

It features MAX7219 8-digit LED display driver module as well as 64 RED LEDs.

MSRP - \$15⁰⁰
MIKROE-1295

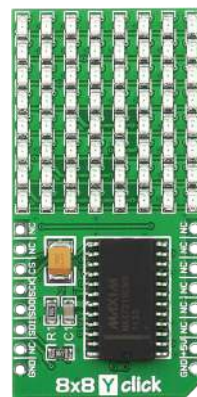

8x8 Y click

5V 3.3V SPI I2C
UART GPIO PWM AN

It features MAX7219 8-digit LED display driver module as well as 64 YELLOW LEDs.

MSRP - \$15⁰⁰
MIKROE-1294



Matrix G click

5V 3.3V SPI I2C
UART GPIO PWM AN

Matrix text display with two green 5x7 matrices and two MAX7219 8-bit LED display drivers.

MSRP - \$29⁰⁰
MIKROE-2246

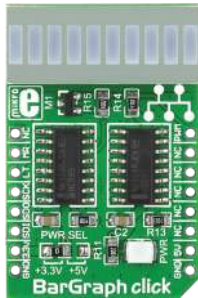

BarGraph click

5V 3.3V SPI I2C

UART GPIO PWM AN

With 10-segment JSB-R102510Z light bar display and two 74HC595 8-bit shift registers.

MSRP - \$12⁰⁰
MIKROE-1423

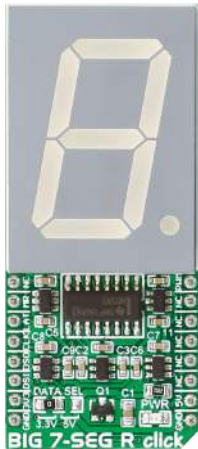

BIG 7-SEG R click

5V 3.3V SPI I2C

UART GPIO PWM AN

With SC10-21SR-WA seven-segment display and parallel-OUT shift register 74HC595.

MSRP - \$19⁰⁰
MIKROE-2269

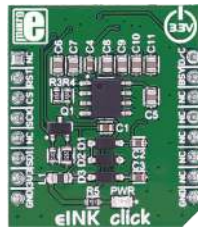

eINK click

5V 3.3V SPI I2C

UART GPIO PWM AN

With an adapter for connecting eInk displays, with a 24pin ribbon cable.

MSRP - \$59⁰⁰
MIKROE-2659



EVE click

5V 3.3V SPI I2C

UART GPIO PWM AN

Brings visually stunning graphics even to 8-bit MCUs, with FT800Q graphics controller.

MSRP - \$39⁰⁰
MIKROE-1430

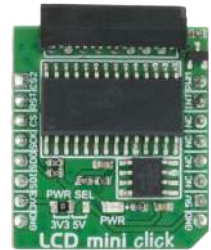

LCD mini click

5V 3.3V SPI I2C

UART GPIO PWM AN

Displays 2x16 mono-chrome characters on an LMB162XFW LCD display.

MSRP - \$19⁰⁰
MIKROE-2453

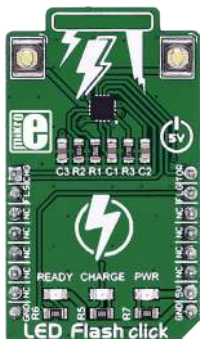

LED Flash click

5V 3.3V SPI I2C

UART GPIO PWM AN

Functions as a high power LED flash, and carries the CAT3224 flash LED driver.

MSRP – \$34⁰⁰
MIKROE-2479

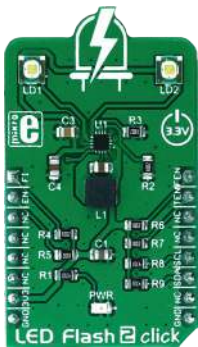

LED Flash 2 click

5V 3.3V SPI I2C

UART GPIO PWM AN

It is a powerful flash/torch click, featuring the MIC2870 from Microchip.

MSRP – \$19⁰⁰
MIKROE-2830

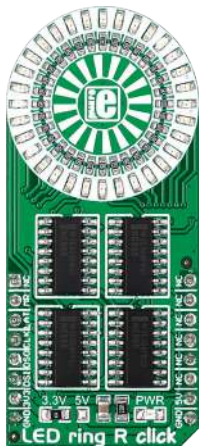

Led ring R click

5V 3.3V SPI I2C

UART GPIO PWM AN

With a ring of 32 red LEDs driven by four 74HC595 serial-in, parallel-out shift registers.

MSRP – \$16⁰⁰
MIKROE-2153

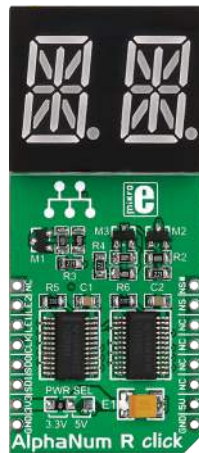

AlphaNum R click

5V 3.3V SPI I2C

UART GPIO PWM AN

With a dual character red LED 14-segment display and two TLC5926 16-bit shift registers.

MSRP – \$15⁰⁰
MIKROE-1864

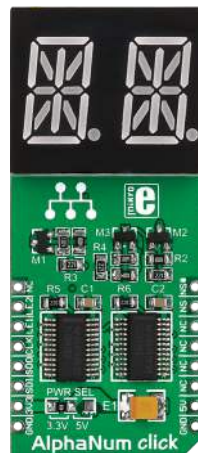

AlphaNum G click

5V 3.3V SPI I2C

UART GPIO PWM AN

With a dual character green LED 14-segment display and two TLC5926 16-bit shift registers.

MSRP – \$15⁰⁰
MIKROE-1851



Matrix R click

5V 3.3V SPI I2C
 UART GPIO PWM AN

Matrix text display with two red 5x7 matrices and two MAX7219 8-bit LED display drivers.

MSRP - \$29⁰⁰
 MIKROE-2245



Matrix RGB click

5V 3.3V SPI I2C
 UART GPIO PWM AN

Powered by a 32-bit FT900 MCU designed specifically for powering 16x32 RGB LED matrices.

MSRP - \$24⁰⁰
 MIKROE-2239



OLED B click

5V 3.3V SPI I2C
 UART GPIO PWM AN

With a 96 x 39px blue monochrome passive matrix OLED display and SSD1306 controller.

MSRP - \$24⁰⁰
 MIKROE-1650



OLED C click

5V 3.3V SPI I2C
 UART GPIO PWM AN

With PSP27801 OLED display and SSD1351 OLED driver with controller. Various color support.

MSRP - \$29⁰⁰
 MIKROE-1585



OLED Switch click

5V 3.3V SPI I2C
 UART GPIO PWM AN

With NKK Switch IS-C15ANP4 that combines a switch and a full color organic LED display.

MSRP - \$99⁰⁰
 MIKROE-2449



OLED W click

5V 3.3V SPI I2C

UART GPIO PWM AN

Carries a 96x39px white monochrome passive matrix OLED display.

MSRP - \$24⁰⁰
MIKROE-1649

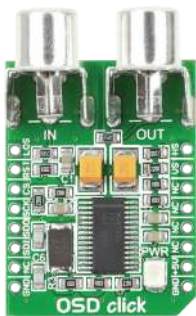

OSD click

5V 3.3V SPI I2C

UART GPIO PWM AN

With MAX7456 single-channel monochrome OSD module with integrated EEPROM memory.

MSRP - \$35⁰⁰
MIKROE-1366



UT-L 7-SEG R click

5V 3.3V SPI I2C

UART GPIO PWM AN

With two SMD ultra-thin LED 7-SEG displays and MAX6969 constant-current LED driver.

MSRP - \$44⁰⁰
MIKROE-2034

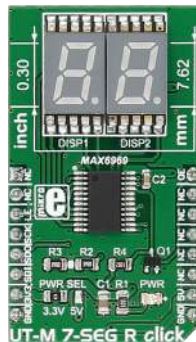

UT-M 7-SEG R click

5V 3.3V SPI I2C

UART GPIO PWM AN

Add a double 7 segment display to your next project. RED emitting color.

MSRP - \$20⁰⁰
MIKROE-2746

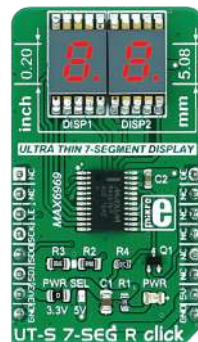

UT-S 7-SEG R click

5V 3.3V SPI I2C

UART GPIO PWM AN

For displaying characters on two 7 segment displays. RED emitting color.

MSRP - \$20⁰⁰
MIKROE-2840

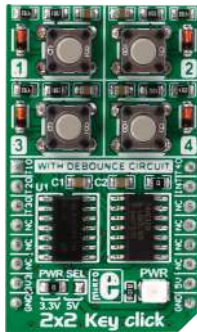

2x2 Key click

5V 3.3V SPI I2C
UART GPIO PWM AN

The click has a 4 button keypad. It allows multiple key presses and has a debounce circuit.

MSRP - \$9⁰⁰
MIKROE-2152

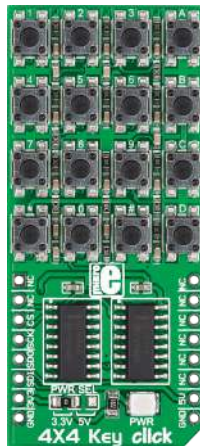

4x4 Key click

5V 3.3V SPI I2C
UART GPIO PWM AN

Carries a 16 button keypad. Allows for multiple key presses at the same time.

MSRP - \$11⁰⁰
MIKROE-1889



Button G click

5V 3.3V SPI I2C
UART GPIO PWM AN

A single pushbutton - transparent, 6.8mm in diameter, with a green LED backlight.

MSRP - \$9⁰⁰
MIKROE-2040

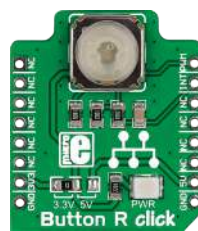

Button R click

5V 3.3V SPI I2C
UART GPIO PWM AN

A single pushbutton - transparent, 6.8mm in diameter, with a red LED backlight.

MSRP - \$9⁰⁰
MIKROE-1901



Cap Extend click

5V 3.3V SPI I2C
UART GPIO PWM AN

With SX8633, capacitive button touch controller. 12 pins for connecting capacitive inputs.

MSRP - \$18⁰⁰
MIKROE-2238



CapSense click

5V 3.3V SPI I2C

UART GPIO PWM AN

Capacitive sensing module. Input- human body capacitance, output - the real time sensor information.

MSRP - \$16⁰⁰
MIKROE-1446



COUNTER click

5V 3.3V SPI I2C

UART GPIO PWM AN

Counter click carries an LS7366R 32-bit quadrature counter.

MSRP - \$25⁰⁰
MIKROE-1917



FingerPrint click

5V 3.3V SPI I2C

UART GPIO PWM AN

Solution for adding biometric security to your design.

MSRP - \$55⁰⁰
MIKROE-1722

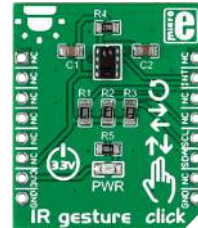

IR gesture click

5V 3.3V SPI I2C

UART GPIO PWM AN

Enables contactless gesture recognition. With ambient light and proximity sensing capabilities.

MSRP - \$16⁰⁰
MIKROE-2086

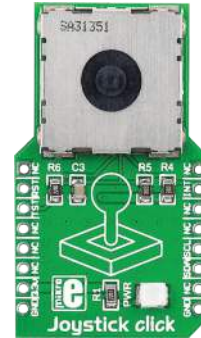

Joystick click

5V 3.3V SPI I2C

UART GPIO PWM AN

A smart navigation key concept based on contactless, magnetic movement detection.

MSRP - \$22⁰⁰
MIKROE-1506



Keylock click

5V 3.3V SPI I2C
UART GPIO PWM AN

Carries a processed sealed key lock mechanism that can be set in 3 different positions.

MSRP - \$25⁰⁰
MIKROE-2564

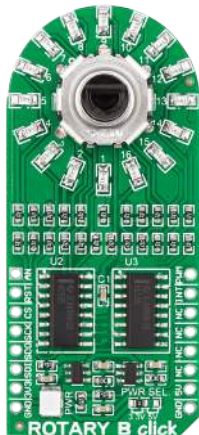

ROTARY B click

5V 3.3V SPI I2C
UART GPIO PWM AN

With a 15-pulse incremental rotary encoder with detents, surrounded by a ring of 16 blue LEDs.

MSRP - \$12⁰⁰
MIKROE-1824

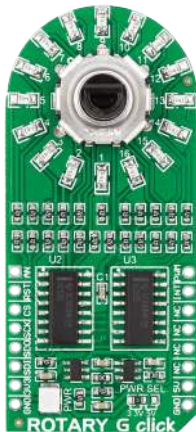

ROTARY G click

5V 3.3V SPI I2C
UART GPIO PWM AN

With a 15-pulse incremental rotary encoder with detents, surrounded by a ring of 16 green LEDs.

MSRP - \$12⁰⁰
MIKROE-1822

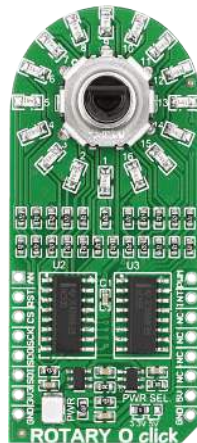

ROTARY O click

5V 3.3V SPI I2C
UART GPIO PWM AN

With a 15-pulse incremental rotary encoder with detents, surrounded by a ring of 16 orange LEDs.

MSRP - \$12⁰⁰
MIKROE-2380

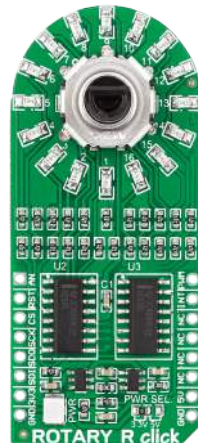

ROTARY R click

5V 3.3V SPI I2C
UART GPIO PWM AN

With a 15-pulse incremental rotary encoder with detents, surrounded by a ring of 16 red LEDs.

MSRP - \$12⁰⁰
MIKROE-1823

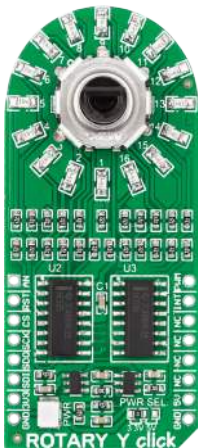

ROTARY Y click

5V 3.3V SPI I2C

UART GPIO PWM AN

With a 15-pulse incremental rotary encoder with detents, surrounded by a ring of 16 yellow LEDs.

MSRP – \$12⁰⁰
MIKROE-1825



SpeakUp 2 click

5V 3.3V SPI I2C

UART GPIO PWM AN

A speech recognition click. Set it up to recognize up to 100 commands.

MSRP – \$34⁰⁰
MIKROE-2375



Thumbstick click

5V 3.3V SPI I2C

UART GPIO PWM AN

A high precision input device with a dual axis, spring return and push-button enabled joystick.

MSRP – \$20⁰⁰
MIKROE-1627



Thumb wheel click

5V 3.3V SPI I2C

UART GPIO PWM AN

With a 10-position rotary sprocket connected to a 1-Wire 8-Channel Addressable Switch.

MSRP – \$29⁰⁰
MIKROE-2366



TouchClamp click

5V 3.3V SPI I2C

UART GPIO PWM AN

With NXP's MPR121 proximity capacitive touch sensor controller. 7 plated holes for clamps.

MSRP – \$9⁰⁰
MIKROE-2294

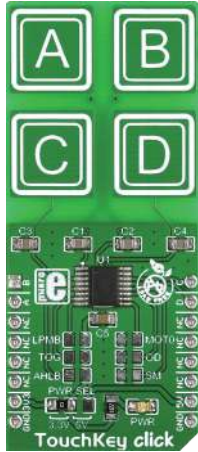

TouchKey click

5V 3.3V SPI I2C
UART GPIO PWM AN

It has four capacitive pads powered by TTP224, a touchpad detector IC.

MSRP - \$12⁰⁰
MIKROE-1906



TouchKey 2 click

5V 3.3V SPI I2C
UART GPIO PWM AN

With 4 capacitive pads powered by Microchip's ATtiny817. Integrated touch QTouch® controller.

MSRP - \$16⁰⁰
MIKROE-2474



Touchpad click

5V 3.3V SPI I2C
UART GPIO PWM AN

Capacitive touch input device driven by Microchip's MTCH6102 controller.

MSRP - \$15⁰⁰
MIKROE-1995

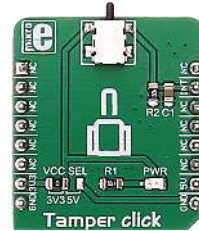

Tammer click

5V 3.3V SPI I2C
UART GPIO PWM AN

Equipped with SDS001, a low profile side-actuated detect switch.

MSRP - \$9⁰⁰
MIKROE-2551

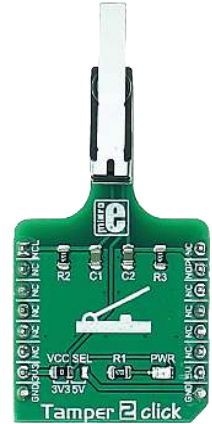

Tammer 2 click

5V 3.3V SPI I2C
UART GPIO PWM AN

Levered D2HW-A221D switch. Outputs signal in both positions - pressed and released.

MSRP - \$15⁰⁰
MIKROE-2552



SpeakUp click

5V 3.3V SPI I2C

UART GPIO PWM AN

A speech recognition click. Can recognize over 200 different voice commands.

MSRP – \$39⁰⁰
MIKROE-1534

It listens
and learns...

Using a simple interface on your computer, you can record a word or phrase (up to 5 seconds) and assign it an instruction. Repeat as many commands as you need.

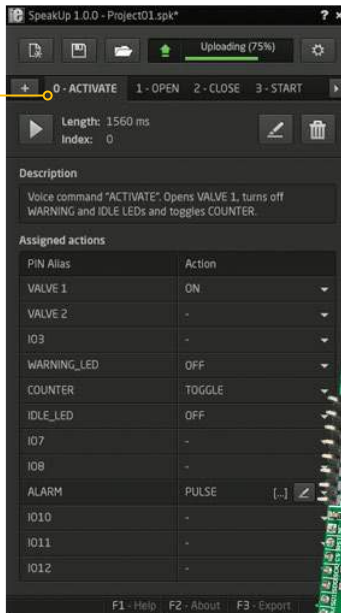

SpeakUp

...understands
and obeys



When you put it to work, it listens to what you're saying, matches the sound to one of the pre-recorded commands, and triggers the specified action which the on-board MCU executes.

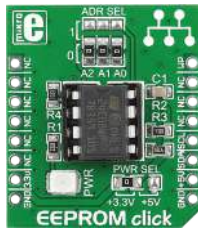

EEPROM click

5V 3.3V SPI I2C

UART GPIO PWM AN

With 24C08WP - a highly reliable, high performance CMOS technology serial 8K EEPROM.

MSRP - \$8⁰⁰
MIKROE-1200



EEPROM 2 click

5V 3.3V SPI I2C

UART GPIO PWM AN

With M95M02-DR DIP-8 socket EEPROM chip with 256 KB of memory from STMicroelectronics.

MSRP - \$18⁰⁰
MIKROE-1909



EEPROM 3 click

5V 3.3V SPI I2C

UART GPIO PWM AN

With AT24CM02 DIP-8 socket EEPROM chip with 256 KB of memory from Microchip.

MSRP - \$14⁰⁰
MIKROE-1989

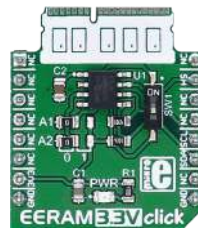

EERAM 3.3V click

5V 3.3V SPI I2C

UART GPIO PWM AN

With 47L16 EERAM, a 16Kbit SRAM with EEPROM Backup from Microchip.

MSRP - \$14⁰⁰
MIKROE-2728

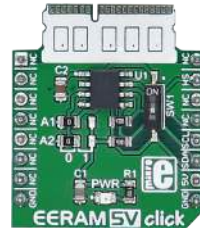

EERAM 5V click

5V 3.3V SPI I2C

UART GPIO PWM AN

With 47C16 EERAM, a 16Kbit SRAM with EEPROM Backup from Microchip.

MSRP - \$14⁰⁰
MIKROE-2729

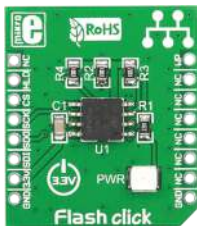

Flash click

5V : 3.3V : SPI : I2C
 UART : GPIO : PWM : AN

With EN25Q80B - 8Mb serial Flash memory module. Clock frequency up to 75MHz.

MSRP - \$10⁰⁰
 MIKROE-1199

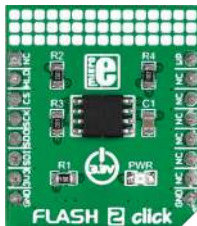

Flash 2 click

5V : 3.3V : SPI : I2C
 UART : GPIO : PWM : AN

It carries Microchip's SST26VF064B flash-memory module with 64 Mbits capacity.

MSRP - \$12⁰⁰
 MIKROE-2267

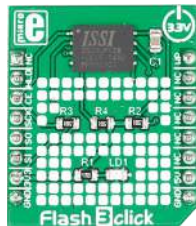

Flash 3 click

5V : 3.3V : SPI : I2C
 UART : GPIO : PWM : AN

With ISSI's IS25LP128 IC with 128 Mbit capacity. 50MHz at Normal, 133MHz at Fast Read speeds.

MSRP - \$12⁰⁰
 MIKROE-2374

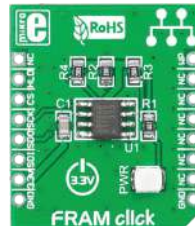

FRAM click

5V : 3.3V : SPI : I2C
 UART : GPIO : PWM : AN

256K [32,768 words x 8 bits] of Ferroelectric Random Access Memory with MB85RS256A module.

MSRP - \$15⁰⁰
 MIKROE-1486



FRAM 2 click

5V : 3.3V : SPI : I2C
 UART : GPIO : PWM : AN

With CY15B104Q 4-Mbit [512K x 8] serial F-RAM from Cypress. 100 trillion [10¹⁴] read/writes.

MSRP - \$19⁰⁰
 MIKROE-2768



MAC Address click

5V 3.3V SPI I2C

UART GPIO PWM AN

A unique node address. Carries 24AA025E64 2Kb Serial EEPROM with EUI-64™ node identity.

MSRP - \$9⁰⁰
MIKROE-2733



microSD click

5V 3.3V SPI I2C

UART GPIO PWM AN

With a microSD card slot for microSD cards used as a mass storage media for portable devices.

MSRP - \$16⁰⁰
MIKROE-924



Secure click

5V 3.3V SPI I2C

UART GPIO PWM AN

With ATECC508A cryptographic coprocessor with secure hardware-based key storage.

MSRP - \$9⁰⁰
MIKROE-2522



Secure 2 click

5V 3.3V SPI I2C

UART GPIO PWM AN

Microchip's ATAES132A, a cryptographic coprocessor with secure hardware-based key storage.

MSRP - \$9⁰⁰
MIKROE-2760



Secure 3 click

5V 3.3V SPI I2C

UART GPIO PWM AN

Microchip's ATSHA204A, a cryptographic coprocessor with secure hardware-based key storage.

MSRP - \$9⁰⁰
MIKROE-2761

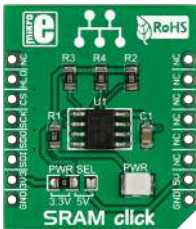

SRAM click

5V | 3.3V | SPI | I2C

UART | GPIO | PWM | AN

Provides 1 Mbit of additional SRAM memory, via Microchip's 23LC1024.

MSRP – \$15⁰⁰
MIKROE-1902

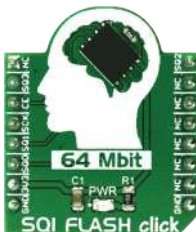

SQI FLASH click

5V | 3.3V | SPI | I2C

UART | GPIO | PWM | AN

Based on the SST-26VF064B, a 64 Mbit Serial Quad I/O flash device from Microchip.

MSRP – \$13⁹⁰
MIKROE-2828

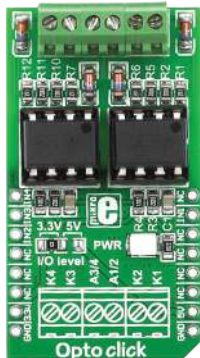

Opto click

5V | 3.3V | SPI | I2C
 UART | GPIO | PWM | AN

It features two V02630 dual channel, high speed optocoupler modules.

MSRP – \$21⁰⁰
 MIKROE-1196



RELAY click

5V | 3.3V | SPI | I2C
 UART | GPIO | PWM | AN

With two G6D1AA-5DC power PCB relay modules. Controls up to 5A, 250V AC/30V DC loads.

MSRP – \$18⁰⁰
 MIKROE-1370

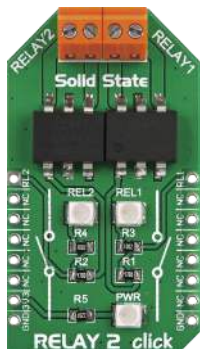

Relay 2 click

5V | 3.3V | SPI | I2C
 UART | GPIO | PWM | AN

Carries two LCA717 single-pole, OptoMOS® solid state relays.

MSRP – \$26⁰⁰
 MIKROE-1899

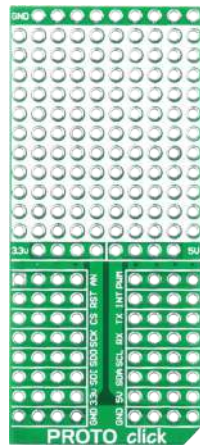

PROTO click

5V | 3.3V | SPI | I2C
 UART | GPIO | PWM | AN

10x11 prototyping area and additional power pads for creating custom electronics or Click boards™.

MSRP – \$4⁵⁰
 MIKROE-1507



FLICKER click

5V | 3.3V | SPI | I2C
 UART | GPIO | PWM | AN

TI's NA556 dual precision timer and Omron's G6D-ASI power PCB relay. ON/OFF 0.1-6 sec.

MSRP – \$19⁰⁰
 MIKROE-2481



Signal Relay click

5V | 3.3V | SPI | I2C
 UART | GPIO | PWM | AN

It carries four ultra-small GV5-1 PCB relays from Omron. For ON/OFF control.

MSRP - \$29⁰⁰
 MIKROE-2154

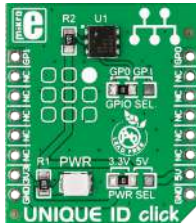

UNIQUE ID click

5V | 3.3V | SPI | I2C
 UART | GPIO | PWM | AN

With DS2401 enhanced silicon serial number IC. Provides a unique registration number.

MSRP - \$9⁰⁰
 MIKROE-1819

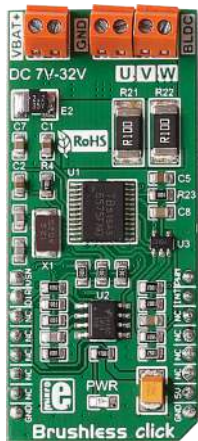

Brushless click

5V 3.3V SPI I2C
 UART GPIO PWM AN

Toshiba's TB6575F-NG IC for driving 3-phase full-wave Brushless DC motors.

MSRP - \$39⁰⁰
 MIKROE-2441



Brushless 2 click

5V 3.3V SPI I2C
 UART GPIO PWM AN

It carries TI's DRV10964 BLDC motor controller with an integrated output stage.

MSRP - \$26⁰⁰
 MIKROE-2754



Brushless 3 click

5V 3.3V SPI I2C
 UART GPIO PWM AN

With TI's DRV10983 three-phase sensorless motor driver with integrated power MOSFETs.

MSRP - \$19⁰⁰
 MIKROE-2766



DC MOTOR click

5V 3.3V SPI I2C
 UART GPIO PWM AN

With TI's DRV8833RTH-Bridge motor driver and TI's 74HC4053 multiplexer.

MSRP - \$18⁰⁰
 MIKROE-1526



DC MOTOR 2 click

5V 3.3V SPI I2C
 UART GPIO PWM AN

With Toshiba's TB6593F-NG driver IC for direct current motors. Motors' supply voltage 2.5V-13V.

MSRP - \$17⁰⁰
 MIKROE-2699



DC MOTOR 3 click

5V 3.3V SPI I2C

UART GPIO PWM AN

With Toshiba's TB-6549FG full-bridge driver for direct current motors. Up to 3.5A with 30V.

MSRP - \$19⁰⁰
MIKROE-2047

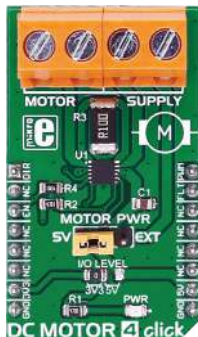

DC MOTOR 4 click

5V 3.3V SPI I2C

UART GPIO PWM AN

With MAX14870 motor driver from Maxim Integrated. Motors' voltage supply 4.5V-36V.

MSRP - \$15⁰⁰
MIKROE-2221



DC MOTOR 5 click

5V 3.3V SPI I2C

UART GPIO PWM AN

With TI's DRV8701 brushed DC motor full-bridge gate driver. Operating voltage supply 5.9V-45V.

MSRP - \$17⁰⁰
MIKROE-2699



Fan click

5V 3.3V SPI I2C

UART GPIO PWM AN

With EMC2301 controller for powering and regulating the operation of 5V four-wire fans.

MSRP - \$9⁹⁰
MIKROE-2004



Fan 2 click

5V 3.3V SPI I2C

UART GPIO PWM AN

With MAX31760 precision fan-speed controller. Can control two fans at the same time.

MSRP - \$15⁰⁰
MIKROE-2708



HAPTIC click

5V | 3.3V | SPI | I2C

UART | GPIO | PWM | AN

With DRV2605 Haptic Driver for ERM and LRA vibration motors. Over 100 haptic effects library.

MSRP - \$23⁰⁰
MIKROE-2025



PWM driver click

5V | 3.3V | SPI | I2C

UART | GPIO | PWM | AN

Silicon Labs' Si8711CC one-channel isolator for controlling DC motors with loads up to 10A.

MSRP - \$14⁰⁰
MIKROE-2272



STEPPER click

5V | 3.3V | SPI | I2C

UART | GPIO | PWM | AN

With A3967SLBT microstepping motor driver with a built-in translator. Max. output drive 30V, ±500 mA.

MSRP - \$18⁰⁰
MIKROE-1528

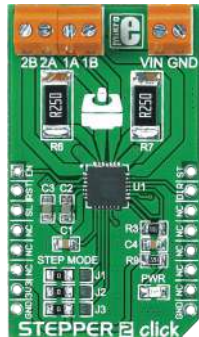

STEPPER 2 click

5V | 3.3V | SPI | I2C

UART | GPIO | PWM | AN

With A4988 microstepping motor driver. Required external power supply minimum 7V.

MSRP - \$19⁰⁰
MIKROE-1926

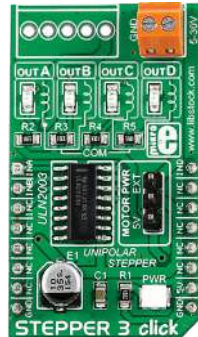

STEPPER 3 click

5V | 3.3V | SPI | I2C

UART | GPIO | PWM | AN

With TI's ULN2003 High-Current Darlington transistor array. For precise motor control.

MSRP - \$19⁰⁰
MIKROE-2035



STEPPER 4 click

5V 3.3V SPI I2C

UART: GPIO: PWM: AN

With TB67S269FTG two-phase bipolar stepping motor driver from Toshiba.

MSRP – \$19⁰⁰
MIKROE-2748

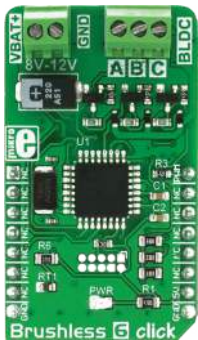

Brushless 6 click

5V 3.3V SPI I2C

UART: GPIO: PWM: AN

Designed to drive a three-phase sensorless, brushless motor. With AT-mega8A from Microchip.

MSRP – \$27⁰⁰
MIKROE-2847



Fan 3 click

5V 3.3V SPI I2C

UART: GPIO: PWM: AN

Perfect solution for speed control. It can operate in seven discrete speed steps.

MSRP – \$17⁸⁰
MIKROE-2841



Vibro Motor click

5V 3.3V SPI I2C

UART: GPIO: PWM: AN

Features a compact size Eccentric Rotating Mass [ERM] motor, labeled as C1026B002F.

MSRP – \$12⁰⁰
MIKROE-2826

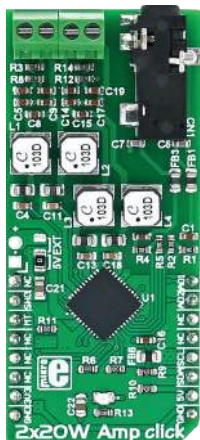

2x20W Amp click

5V 3.3V SPI I2C

UART GPIO PWM AN

Carries MAX9744 stereo class D audio power amplifier from Maxim Integrated.

MSRP - \$21⁰⁰
MIKROE-2779



2x5W AMP click

5V 3.3V SPI I2C

UART GPIO PWM AN

Functions as an amplifier. With TDA7491LP 2x5-watt dual BTL class-D audio amplifier.

MSRP - \$19⁰⁰
MIKROE-2477



AudioAmp click

5V 3.3V SPI I2C

UART GPIO PWM AN

A mono audio amplifier. With TI's LM48100Q-1 Boomer™ Mono, 1.3W Audio Power Amplifier IC.

MSRP - \$14⁰⁰
MIKROE-2368



BUZZ click

5V 3.3V SPI I2C

UART GPIO PWM AN

Features a piezo speaker capable of emitting audio signals. Resonant frequency 3.8 kHz.

MSRP - \$9⁰⁰
MIKROE-945



BUZZ 2 click

5V 3.3V SPI I2C

UART GPIO PWM AN

With CMT-8540S-SMT magnetic buzzer transducer. The buzzer's resonant frequency is 4 kHz.

MSRP - \$12⁰⁰
MIKROE-2720



FM click

5V | 3.3V | SPI | I2C
 UART | GPIO | PWM | AN

Features Si4703 IC and functions as a FM radio tuner. Supports worldwide FM band [76–108 MHz].

MSRP – \$29⁰⁰
 MIKROE-1431



GainAMP click

5V | 3.3V | SPI | I2C
 UART | GPIO | PWM | AN

Carries LTC[®]6912 dual channel, low noise, digitally programmable gain amplifier (PGA).

MSRP – \$15⁰⁰
 MIKROE-2555

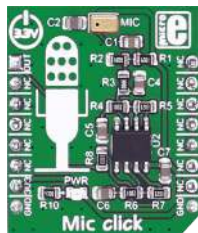

Mic click

5V | 3.3V | SPI | I2C
 UART | GPIO | PWM | AN

With SPQ0410HR5H-B surface mount silicon microphone with max. RF protection.

MSRP – \$9⁰⁰
 MIKROE-2563



MP3 click

5V | 3.3V | SPI | I2C
 UART | GPIO | PWM | AN

With a stereo MP3 decoder VS1053. Multiple formats [MP3, MP1, MP2, MPEG4, etc.].

MSRP – \$21⁹⁰
 MIKROE-946

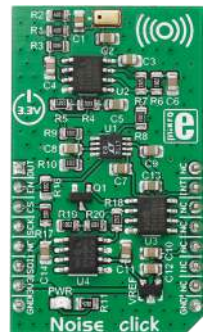

Noise click

5V | 3.3V | SPI | I2C
 UART | GPIO | PWM | AN

With noise detecting circuitry. Enables you to set a noise detection threshold.

MSRP – \$29⁰⁰
 MIKROE-2371



StereoAmp click

5V 3.3V SPI I2C
 UART GPIO PWM AN

With 2 TI's LM48100Q-Q1 Boomer™ single supply, mono, bridge-tied load amplifier ICs.

MSRP – \$24⁰⁰
 MIKROE-2454



TextToSpeech click

5V 3.3V SPI I2C
 UART GPIO PWM AN

With S1V30120 speech synthesis IC powered by the Fonix DECTalk® v5 speech synthesis engine.

MSRP – \$39⁰⁰
 MIKROE-2253

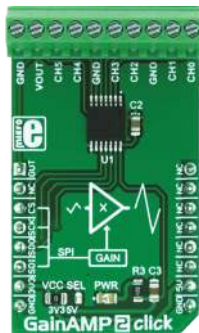

GainAMP 2 click

5V 3.3V SPI I2C
 UART GPIO PWM AN

A 6-channel programmable gain amplifier. Amplifies up to 32x, in eight discrete steps.

MSRP – \$15⁰⁰
 MIKROE-2859



RadioStation click

5V 3.3V SPI I2C
 UART GPIO PWM AN

With the Si4713-B30, the best in class integrated FM broadcast stereo transmitter.

MSRP – \$25⁰⁰
 MIKROE-2822

TILT N SHAKE

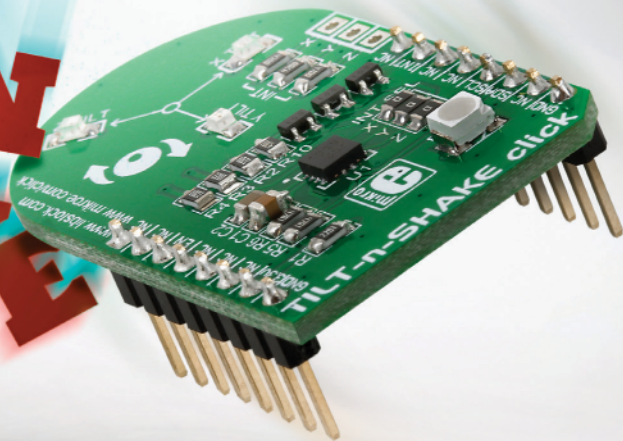

click board™ with
Freescale's unique
two-in-one sensor

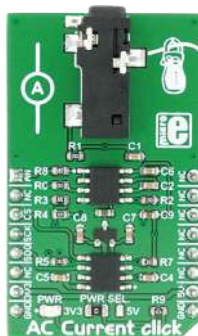

AC Current click

5V 3.3V SPI I2C

UART GPIO PWM AN

Measure alternating currents up to 30A. MCP3201 ADC converter and MCP607 CMOS Op Amp.

MSRP - \$14⁰⁰
MIKROE-2523

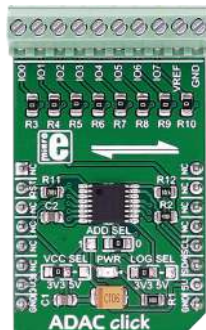

ADAC click

5V 3.3V SPI I2C

UART GPIO PWM AN

It's an 8-channel 12-bit ADC, DAC and GPIO. With AD5593R configurable ADC/DAC.

MSRP - \$26⁰⁰
MIKROE-2690

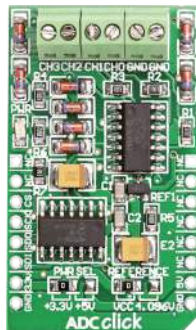

ADC click

5V 3.3V SPI I2C

UART GPIO PWM AN

With Microchip's MCP3204 12-bit Analog-to-Digital converter.

MSRP - \$24⁰⁰
MIKROE-922



ADC 2 click

5V 3.3V SPI I2C

UART GPIO PWM AN

With MCP3551/3, a 22-bit ADC with automatic internal offset and gain calibration.

MSRP - \$24⁰⁰
MIKROE-1893

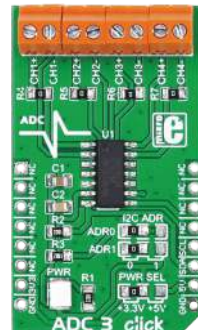

ADC 3 click

5V 3.3V SPI I2C

UART GPIO PWM AN

With Microchip's MCP3428 16-bit multichannel analog-to-digital converter.

MSRP - \$22⁰⁰
MIKROE-1894

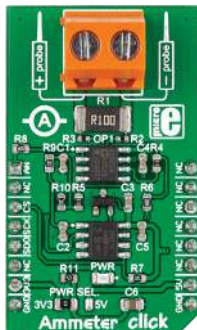

Ammeter click

5V 3.3V SPI I2C

UART GPIO PWM AN

With circuitry for measuring electric current (AC and DC), 0.1A-1A measurement range.

MSRP - \$24⁰⁰
MIKROE-2377

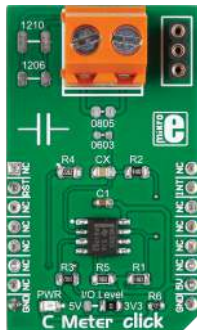

C Meter click

5V 3.3V SPI I2C

UART GPIO PWM AN

Circuitry for measuring the value of capacitors. Based on NE-555 timer/square-wave generator.

MSRP - \$9⁰⁰
MIKROE-2376



Comparator click

5V 3.3V SPI I2C

UART GPIO PWM AN

Carries LM2903 IC, has two independent precision voltage comparators. 2 mV offset voltage.

MSRP - \$12⁰⁰
MIKROE-1915

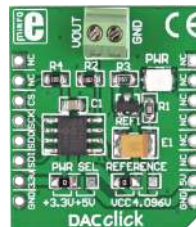

DAC click

5V 3.3V SPI I2C

UART GPIO PWM AN

Includes a 12-bit Digital-to-Analog Converter MCP4921 from Microchip.

MSRP - \$18⁰⁰
MIKROE-950

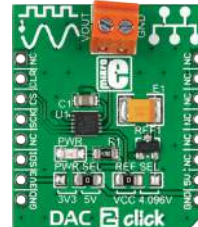

DAC 2 click

5V 3.3V SPI I2C

UART GPIO PWM AN

Carries LTC2601CDD, a 16-bit digital-to-analog converter from Linear Technology.

MSRP - \$19⁰⁰
MIKROE-1918

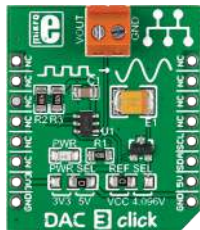

DAC 3 click

5V 3.3V SPI I2C
UART GPIO PWM AN

Carries Microchip's MCP4726 IC, a 12-bit digital-to-analog converter.

MSRP - \$18⁰⁰
MIKROE-2038

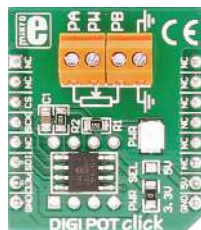

DIGI POT click

5V 3.3V SPI I2C
UART GPIO PWM AN

Carries MCP416 single-channel 8-bit resolution [256 wiper steps] digital potentiometer.

MSRP - \$16⁹⁰
MIKROE-923



DIGI POT 2 click

5V 3.3V SPI I2C
UART GPIO PWM AN

Carries a single channel digital potentiometer TPL0501 with 256 wiper positions.

MSRP - \$16⁹⁰
MIKROE-2332



LEM click

5V 3.3V SPI I2C
UART GPIO PWM AN

Measures AC and DC current [up to 200 KHz]. With LTS 6-NP current transducer.

MSRP - \$59⁰⁰
MIKROE-2553

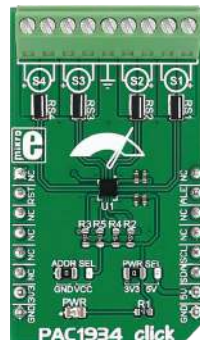

PAC1934 click

5V 3.3V SPI I2C
UART GPIO PWM AN

Carries PAC1934 four channel DC power/energy monitor from Microchip.

MSRP - \$29⁰⁰
MIKROE-2735

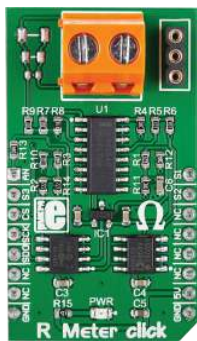

R Meter click

5V 3.3V SPI I2C

UART GPIO PWM AN

With circuitry for measuring the value of resistors. A wide range of resistors [0-1 Mega Ohm].

MSRP – \$27⁰⁰
MIKROE-2396

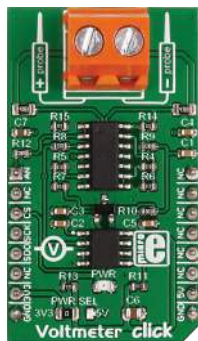

Voltmeter click

5V 3.3V SPI I2C

UART GPIO PWM AN

For measuring voltage in an external electric circuit. Measures direct current [from 0 to 24V].

MSRP – \$24⁰⁰
MIKROE-2436



ADC 4 click

5V 3.3V SPI I2C

UART GPIO PWM AN

An advanced analog to digital multichannel converter. It can work in 16bit or 24bit mode.

MSRP – \$65⁰⁰
MIKROE-2879

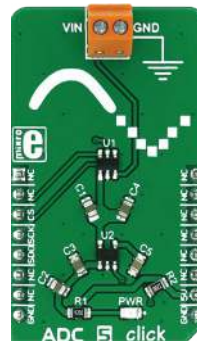

ADC 5 click

5V 3.3V SPI I2C

UART GPIO PWM AN

With a low power, single channel 12-bit CMOS analog to digital converter.

MSRP – \$18⁰⁰
MIKROE-2846

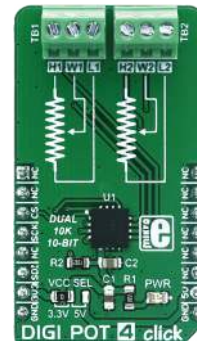

DIGI POT 4 click

5V 3.3V SPI I2C

UART GPIO PWM AN

A digitally controlled dual potentiometer, with the resistance of 10KΩ.

MSRP – \$21⁰⁰
MIKROE-2873

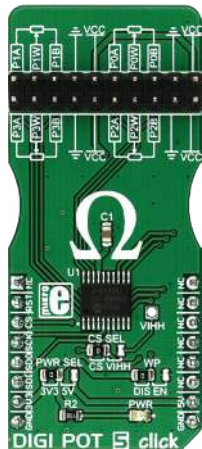

DIGI POT 5 click

5V 3.3V SPI I2C
UART GPIO PWM AN

A digitally controlled quad potentiometer, with the resistance of 10KΩ.

MSRP – \$16⁹⁰
MIKROE-2863



PIXI™ click

5V 3.3V SPI I2C
UART GPIO PWM AN

Features proprietary PIXI™ technology. Configurable 20-channel mixed-signal data converter.

MSRP – \$29⁰⁰
MIKROE-2817



Slider click

5V 3.3V SPI I2C
UART GPIO PWM AN

Features a mechanical slide action potentiometer.

MSRP – \$24⁰⁰
MIKROE-2702



Boost click

5V 3.3V SPI I2C
 UART GPIO PWM AN

Carries Microchip's MIC2606, a 2MHz, PWM DC/DC boost switching regulator.

MSRP - \$21⁰⁰
 MIKROE-2780

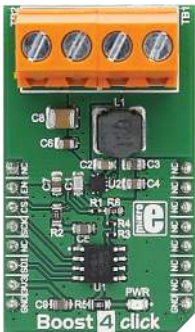

Boost 4 click

5V 3.3V SPI I2C
 UART GPIO PWM AN

Carries TI's TPS61230A, a high efficiency fully integrated synchronous boost converter.

MSRP - \$17⁰⁰
 MIKROE-2752

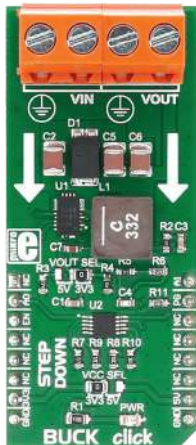

BUCK click

5V 3.3V SPI I2C
 UART GPIO PWM AN

Buck switching regulator. A wide input voltage range of up to 40V. Steps it down to 3.3V or 5V.

MSRP - \$28⁰⁰
 MIKROE-1592



Charger click

5V 3.3V SPI I2C
 UART GPIO PWM AN

Carries a battery charger controller and a battery charge monitor, along with a battery connector.

MSRP - \$22⁰⁰
 MIKROE-2033



LED driver click

5V 3.3V SPI I2C
 UART GPIO PWM AN

Carries MCP1662 high-voltage step-up voltage driver from Microchip.

MSRP - \$15⁰⁰
 MIKROE-2676

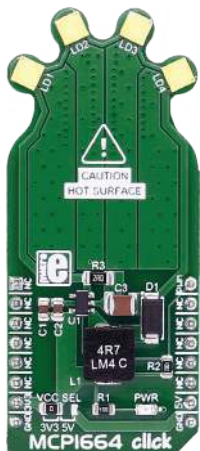
**MCP1664 click**

5V 3.3V SPI I2C
 UART GPIO PWM AN

With 4 high-power white LEDs. Carries Microchip's MCP1664, a high-voltage step-up LED driver.

MSRP – \$26⁰⁰
 MIKROE-2548

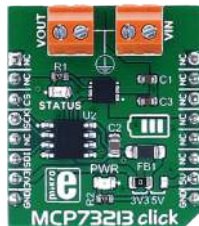
**MCP73213 click**

5V 3.3V SPI I2C
 UART GPIO PWM AN

Carries MCP73213 dual-cell Li-Ion/Li-Polymer battery charge management controller.

MSRP – \$18⁰⁰
 MIKROE-2575

**MIC23099 click**

5V 3.3V SPI I2C
 UART GPIO PWM AN

Carries MIC23099 single AA/AAA cell step-down/step-up regulator with battery monitoring.

MSRP – \$29⁰⁰
 MIKROE-2765

**MIC24045 click**

5V 3.3V SPI I2C
 UART GPIO PWM AN

Carries MIC24045 5A synchronous step-down regulator. Input range 4.5V-19V.

MSRP – \$13⁰⁰
 MIKROE-2574

**VREG click**

5V 3.3V SPI I2C
 UART GPIO PWM AN

Digitally controlled DC voltage regulator. Based on the well-known LM317 circuit.

MSRP – \$24⁰⁰
 MIKROE-2443

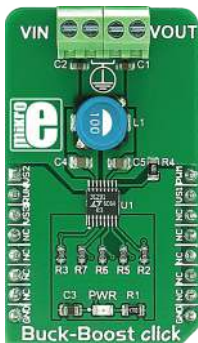

Buck-Boost click

5V 3.3V SPI I2C

UART GPIO PWM AN

Features LTC3129-1, a buck-boost DC/DC conversion integrated circuit.

MSRP - \$20⁰⁰
MIKROE-2806

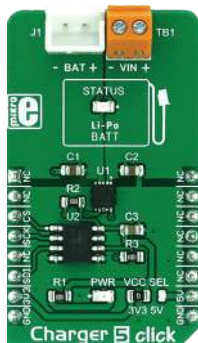

Charger 5 click

5V 3.3V SPI I2C

UART GPIO PWM AN

Designed to charge Lithium-Ion and Lithium-Polymer batteries.

MSRP - \$16⁰⁰
MIKROE-2848

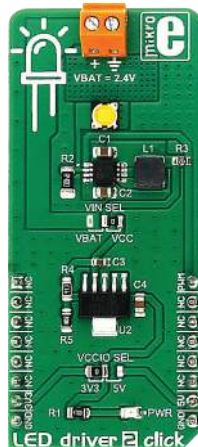

LED driver 2 click

5V 3.3V SPI I2C

UART GPIO PWM AN

Carries the MCP1643 - LED constant current regulator, made by Microchip.

MSRP - \$15⁰⁰
MIKROE-2807

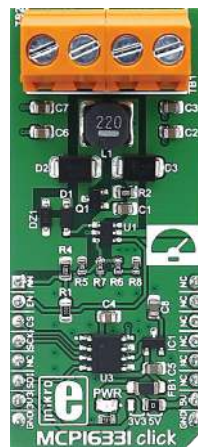

MCP16331 click

5V 3.3V SPI I2C

UART GPIO PWM AN

Functions as a non-inverting buck-boost voltage regulator.

MSRP - \$22⁰⁰
MIKROE-2762

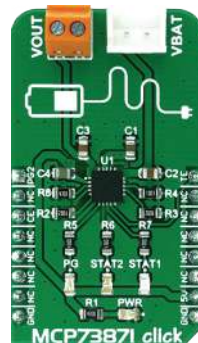

MCP73871 click

5V 3.3V SPI I2C

UART GPIO PWM AN

Integrated solution for system power delivery and Li-Po/Li-Ion battery charge management.

MSRP - \$16⁰⁰
MIKROE-2858

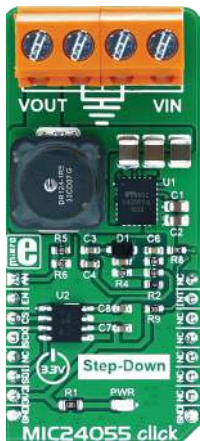

MIC24055 click

5V | 3.3V | SPI | I2C
 UART | GPIO | PWM | AN

Equipped with the MIC24055, high-efficiency buck regulator from Microchip.

MSRP - \$29⁰⁰
 MIKROE-2835

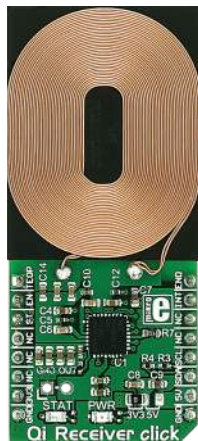

Qi Receiver click

5V | 3.3V | SPI | I2C
 UART | GPIO | PWM | AN

Utilizes the principles of the inductive coupling for the purpose of wireless power transfer.

MSRP - \$18⁰⁰
 MIKROE-2799

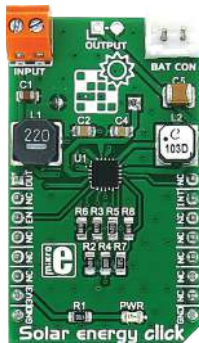

Solar energy click

5V | 3.3V | SPI | I2C
 UART | GPIO | PWM | AN

Uses TI's BQ25570 - a nano-power high-efficiency boost charger and buck converter device.

MSRP - \$27⁰⁰
 MIKROE-2814

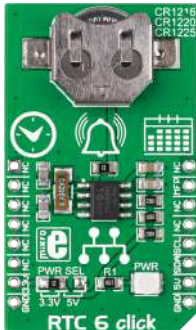

RTC 6 click

5V 3.3V SPI I2C

UART GPIO PWM AN

Carries MCP79410 real-time clock/calendar IC. 64 bytes of battery-backed SRAM.

MSRP – \$21⁰⁰
MIKROE-2063

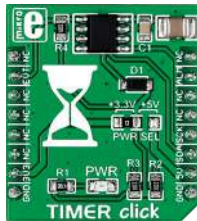

TIMER click

5V 3.3V SPI I2C

UART GPIO PWM AN

With DS1682 total elapsed time recorder from Maxim Integrated. ETC used with the ALARM pin.

MSRP – \$18⁰⁰
MIKROE-2333



Skywire™ click

5V 3.3V SPI I2C

UART GPIO PWM AN

Adapter click, which hosts NimbeLink/Skywire™ cellular modems [using stacking headers].

MSRP – \$19⁰⁰
MIKROE-2405

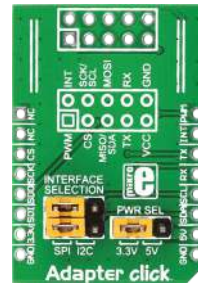

Adapter click

5V 3.3V SPI I2C

UART GPIO PWM AN

Simplifies connection of the add-on boards with IDC10 headers to mikroBUS™ socket.

MSRP – \$6⁵⁰
MIKROE-1432



Riverdi click

5V 3.3V SPI I2C

UART GPIO PWM AN

An adapter for connecting Riverdi TFT displays to a mikroBUS™ socket.

MSRP – \$9⁰⁰
MIKROE-2100



PULSE click

5V 3.3V SPI I2C
UART GPIO PWM AN

A pulse generator with precise frequency control. Features NE555 precision timer.

MSRP - \$25⁰⁰
MIKROE-2032

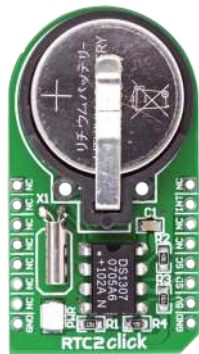

RTC 2 click

5V 3.3V SPI I2C
UART GPIO PWM AN

With DS1307 serial real-time clock. It's a full binary-coded decimal [BCD] clock/calendar.

MSRP - \$21⁰⁰
MIKROE-948

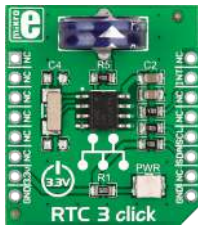

RTC 3 click

5V 3.3V SPI I2C
UART GPIO PWM AN

Carries BQ32000, a real time clock with an integrated trickle charge circuit for automatic switchover.

MSRP - \$21⁰⁰
MIKROE-1839



RTC 4 click

5V 3.3V SPI I2C
UART GPIO PWM AN

Carries DS2417, a real time clock/calendar with a 1-Wire MicroLAN interface. 16.3 kbits per second.

MSRP - \$21⁰⁰
MIKROE-1891

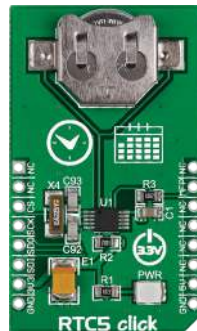

RTC 5 click

5V 3.3V SPI I2C
UART GPIO PWM AN

Carries Micro-chip's MCP79510 real-time clock/calendar.

MSRP - \$21⁰⁰
MIKROE-1890

mikroSDK – MikroElektronika SOFTWARE DEVELOPMENT KIT

mikroe.com/mikrosdk

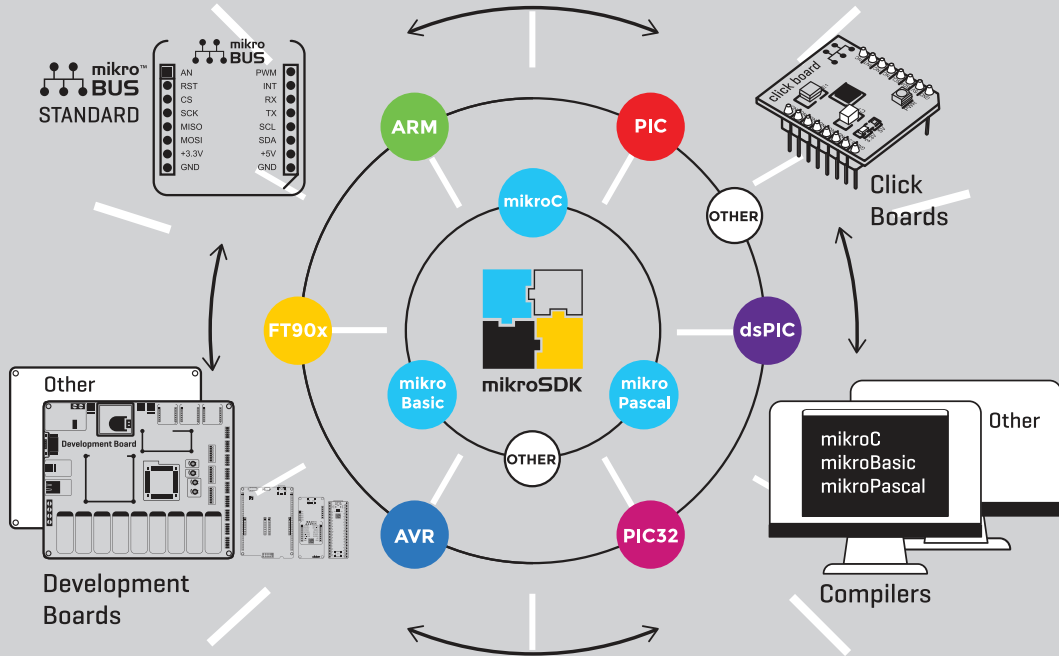

Clicking on all platforms

Use Click boards™ with your favorite development platform. A range of Shields bring click connectivity to:

- **Arduino**
- **BeagleBone Black**
- **Raspberry Pi**
- **Freedom**
- **Launchpad**
- **Discovery and more...**

See them all at: www.mikroe.com/click/shields

mikroBUS Cape

MSRP – \$8⁹⁰
MIKROE-1857



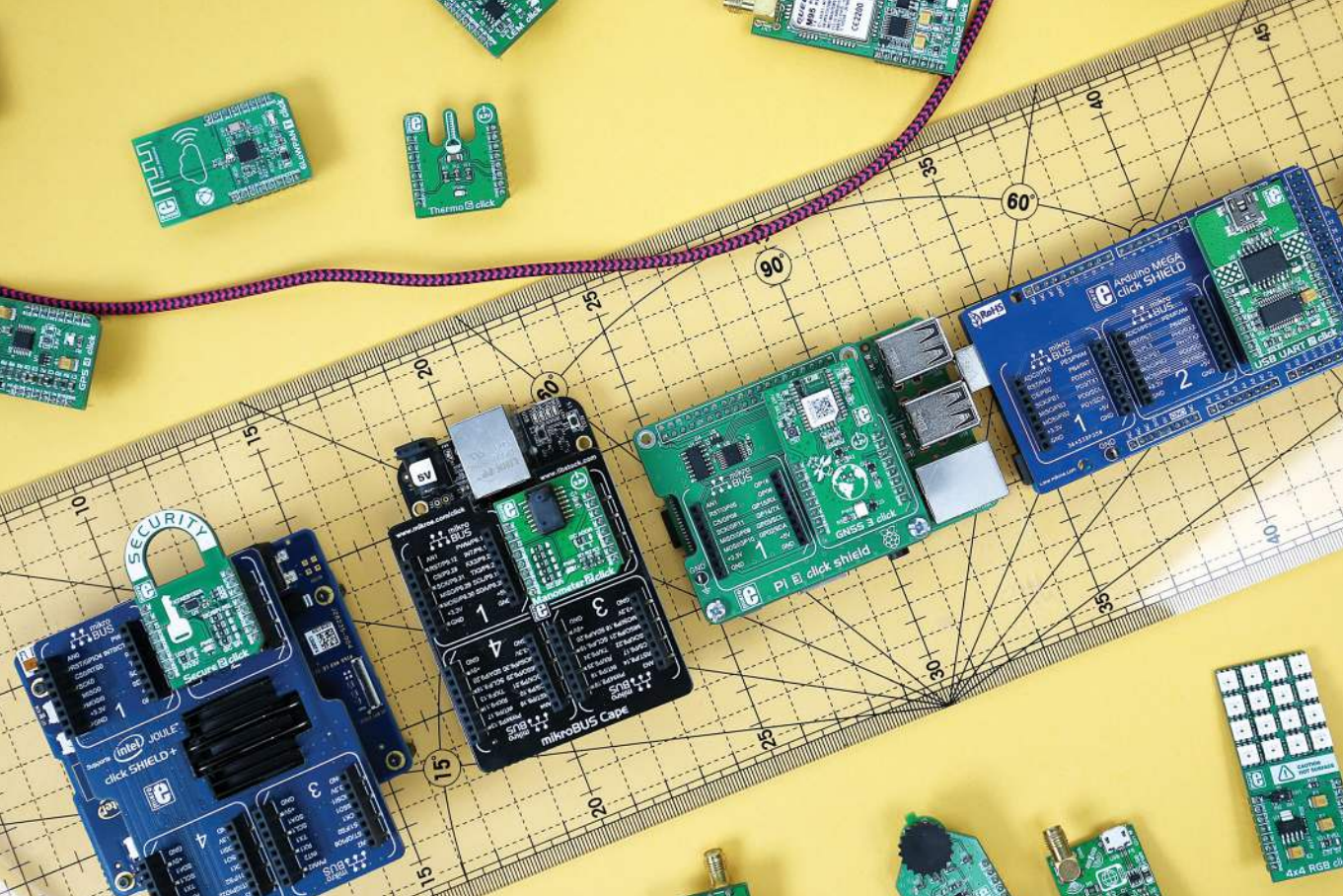

mikroBUS standard

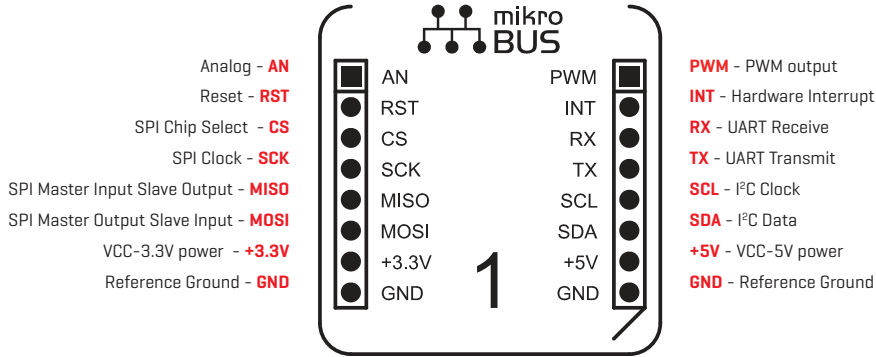

mikroBUS™ is a simple but effective pinout standard containing all the necessary pins to connect all the different Click boards™. There's also a range of mikroBUS™ shields that bring Click board connectivity to all of today's most popular development platforms (Arduino, Raspberry Pi, BeagleBone, Freedom, Discovery, Micro .NET and more).

Using Click boards™ has many advantages but the **time you will save** is by far the **biggest one!**



A gallery wall of framed Arduino boards with various sensors and components. The boards are arranged in a grid-like pattern on a light-colored wall. The boards feature different components like sensors, LEDs, and breadboards. Two pendant lights hang from the ceiling. The text 'MEASURE AND QUANTIFY THE WORLD AROUND YOU!' is overlaid on the left side of the image.

MEASURE AND
QUANTIFY
THE WORLD
AROUND YOU!



NEW click,
yet to come



NEW click,
yet to come



NEW click,
yet to come



NEW click,
yet to come



NEW click,
yet to come

Even though it was printed recently, the booklet you are holding is probably already outdated. That's because we release new Click boards weekly, sometimes daily. For the most current list of clicks, visit:

www.mikroe.com/click

www.mikroe.com/click

