

650 V, 4 A high surge silicon carbide power Schottky diode

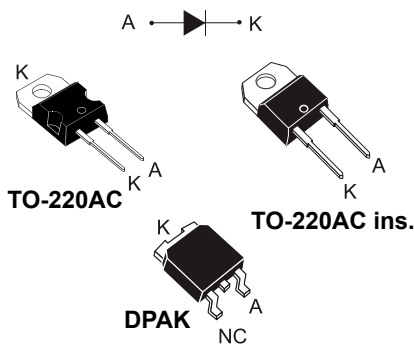

Features

- No reverse recovery charge in application current range
- Switching behavior independent of temperature
- High forward surge capability
- Insulated package TO-220AC Ins:
 - Insulated voltage: 2500 V_{RMS}
 - Typical package capacitance: 7 pF
- Power efficient product
- ECOPACK®2 compliant component

Applications

- Switch mode power supply
- PFC
- DCDC converters
- LLC topologies
- Boost diode

Description

This 4 A, 650 V SiC diode is an ultrahigh performance power Schottky diode. It is manufactured using a silicon carbide substrate. The wide band gap material allows the design of a Schottky diode structure with a 650 V rating. Due to the Schottky construction, no recovery is shown at turn-off and ringing patterns are negligible. The minimal capacitive turn-off behavior is independent of temperature.

This **STPSC4H065** is especially suited for use in PFC applications. This ST SiC diode will boost the performance in hard switching conditions. Its high forward surge capability ensures a good robustness during transient phases.

Product status

STPSC4H065

Product summary

Symbol	Value
I _{F(AV)}	4 A
V _{RRM}	650 V
T _{j(max.)}	175 °C

Product label



1 Characteristics

Table 1. Absolute ratings (limiting values at 25 °C unless otherwise specified)

Symbol	Parameter		Value	Unit
V_{RRM}	Repetitive peak reverse voltage		650	V
$I_{F(RMS)}$	Forward rms current		22	A
$I_{F(AV)}$	Average forward current	TO-220AC, DPAK, $T_c = 145\text{ °C}^{(1)}$, DC	4	A
		TO-220AC Ins, $T_c = 125\text{ °C}^{(1)}$, DC		
I_{FSM}	Surge non repetitive forward current	$t_p = 10\text{ ms}$ sinusoidal, $T_c = 25\text{ °C}$	38	A
		$t_p = 10\text{ ms}$ sinusoidal, $T_c = 125\text{ °C}$	35	
		$t_p = 10\text{ }\mu\text{s}$ square, $T_c = 25\text{ °C}$	200	
I_{FRM}	Repetitive peak forward current	TO-220AC, DPAK, $T_c = 145\text{ °C}^{(1)}$, $T_j = 175\text{ °C}$, $\delta = 0.1$	17	A
		TO-220AC Ins, $T_c = 125\text{ °C}^{(1)}$, $T_j = 175\text{ °C}$, $\delta = 0.1$		
T_{stg}	Storage temperature range		-55 to +175	°C
T_j	Operating junction temperature range ⁽²⁾		-40 to +175	°C

1. Value based on $R_{th(j-c)}$ max.

2. $(dP_{tot}/dT_j) < (1/R_{th(j-a)})$ condition to avoid thermal runaway for a diode on its own heatsink.

Table 2. Thermal resistance parameters

Symbol	Parameter		Typ. value	Max. value	Unit
$R_{th(j-c)}$	Junction to case	TO-220AC, DPAK, D ² PAK	1.8	2.7	°C/W
		TO-220AC Ins	3	4.5	

Table 3. Static electrical characteristics

Symbol	Parameter	Test conditions		Min.	Typ.	Max.	Unit
$I_R^{(1)}$	Reverse leakage current	$T_j = 25\text{ °C}$	$V_R = V_{RRM}$	-	3	40	μA
		$T_j = 150\text{ °C}$		-	35	170	
$V_F^{(2)}$	Forward voltage drop	$T_j = 25\text{ °C}$	$I_F = 4\text{ A}$	-	1.56	1.75	V
		$T_j = 150\text{ °C}$		-	1.98	2.50	

1. $t_p = 10\text{ ms}$, $\delta < 2\%$

2. $t_p = 500\text{ }\mu\text{s}$, $\delta < 2\%$

To evaluate the conduction losses, use the following equation:

$$P = 1.35 \times I_{F(AV)} + 0.288 \times I_{F(RMS)}^2$$

For more information, please refer to the following application notes related to the power losses :

- AN604: Calculation of conduction losses in a power rectifier
- AN4021: Calculation of reverse losses on a power diode

Table 4. Dynamic electrical characteristics

Symbol	Parameter	Test conditions	Typ.	Unit
$Q_{cj}^{(1)}$	Total capacitive charge	$V_R = 400 \text{ V}$	12.5	nC
C_j	Total capacitance	$V_R = 0 \text{ V}, T_c = 25 \text{ }^\circ\text{C}, F = 1 \text{ MHz}$	200	pF
		$V_R = 400 \text{ V}, T_c = 25 \text{ }^\circ\text{C}, F = 1 \text{ MHz}$	21	

1. Most accurate value for the capacitive charge: $Q_{cj}(V_R) = \int_0^{V_R} C_j(V) dV$

1.1 Characteristics (curves)

Figure 1. Forward voltage drop versus forward current (typical values, low level)

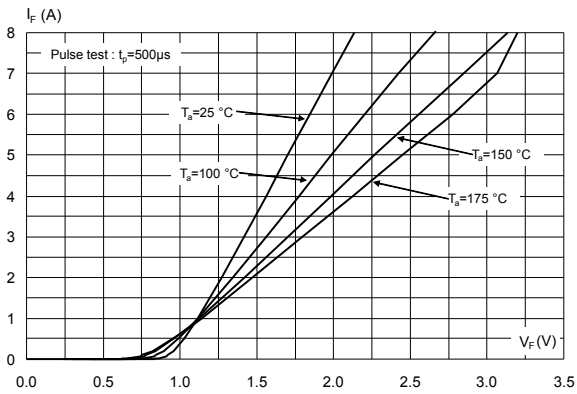

Figure 2. Forward voltage drop versus forward current (typical values, high level)

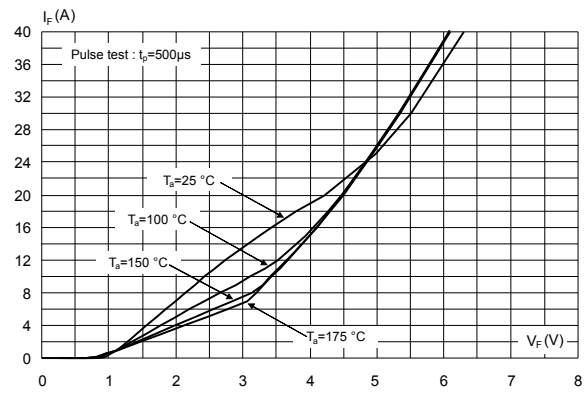

Figure 3. Reverse leakage current versus reverse voltage applied (typical values)

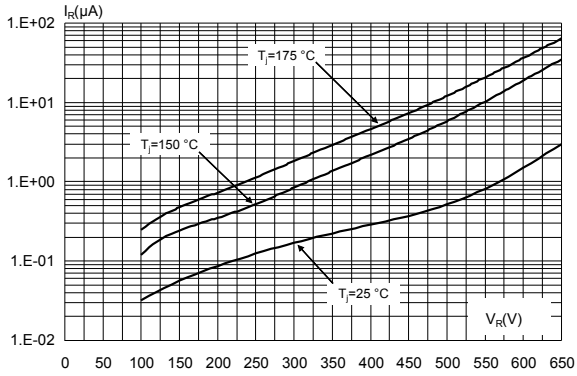

Figure 4. Peak forward current versus case temperature (TO-220AC, DPAK)

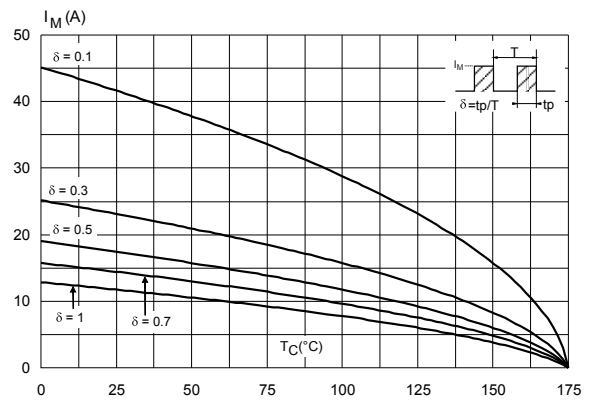

Figure 5. Peak forward current versus case temperature (TO-220AC Ins.)

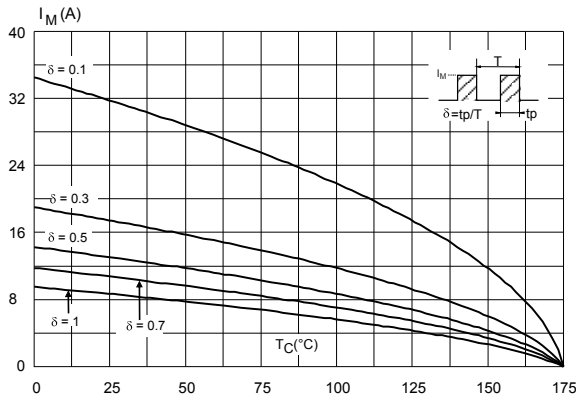

Figure 6. Junction capacitance versus reverse voltage applied (typical values)

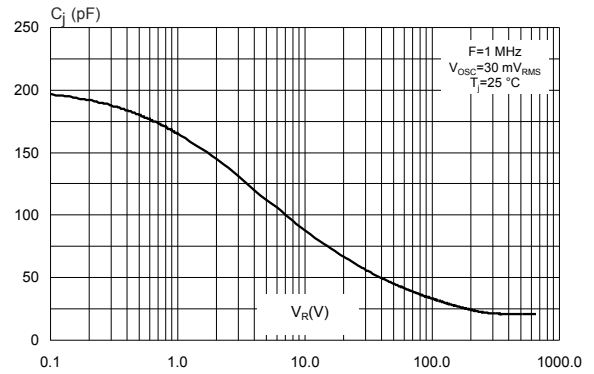

Figure 7. Relative variation of thermal impedance junction to case versus pulse duration (TO-220AC and DPAK)

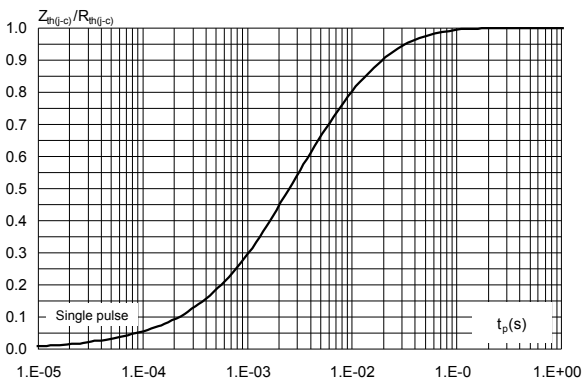

Figure 8. Relative variation of thermal impedance junction to case versus pulse duration (TO-220AC Ins.)

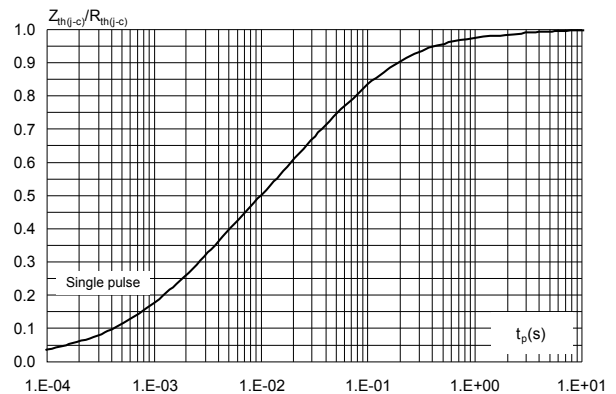

Figure 9. Non-repetitive peak surge forward current versus pulse duration (sinusoidal waveform)

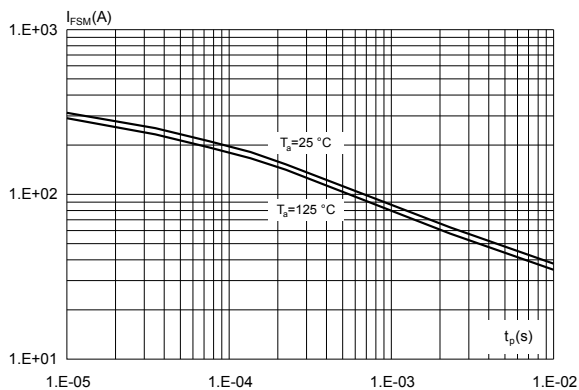

Figure 10. Total capacitive charges versus reverse voltage applied (typical values)

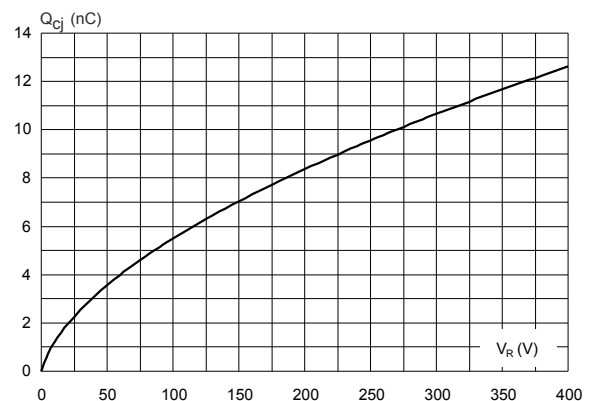

Table 5. TO-220AC package mechanical data

Ref.	Dimensions			
	Millimeters		Inches (for reference only)	
	Min.	Max.	Min.	Max.
A	4.40	4.60	0.173	0.181
C	1.23	1.32	0.048	0.051
D	2.40	2.72	0.094	0.107
E	0.49	0.70	0.019	0.027
F	0.61	0.88	0.024	0.034
F1	1.14	1.70	0.044	0.066
G	4.95	5.15	0.194	0.202
H2	10.00	10.40	0.393	0.409
L2	16.40 typ.		0.645 typ.	
L4	13.00	14.00	0.511	0.551
L5	2.65	2.95	0.104	0.116
L6	15.25	15.75	0.600	0.620
L7	6.20	6.60	0.244	0.259
L9	3.50	3.93	0.137	0.154
M	2.60 typ.		0.102 typ.	
Diam	3.75	3.85	0.147	0.151

2.2 TO-220AC ins. package information

- Epoxy meets UL 94,V0
- Cooling method: by conduction (C)
- Recommended torque value: 0.55 N·m
- Maximum torque value: 0.70 N·m

Figure 12. TO-220AC Ins. package outline

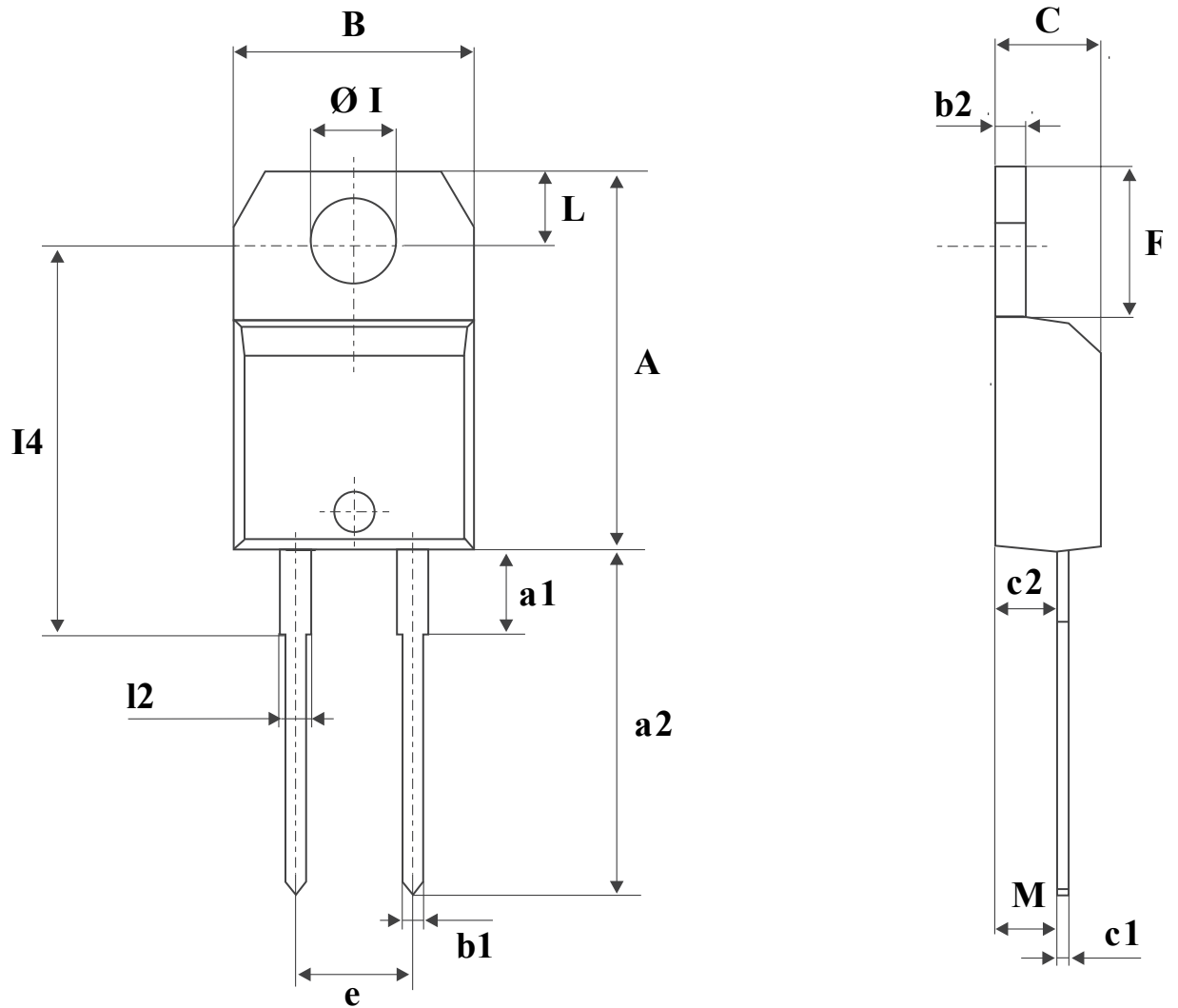

Table 6. TO-220AC Ins. package mechanical data

Ref.	Dimensions					
	Millimeters			Inches (for reference only)		
	Min.	Typ.	Max.	Min.	Typ.	Max.
A	15.20		15.90	0.598		0.625
a1		3.75			0.147	
a2	13.00		14.00	0.511		0.551
B	10.00		10.40	0.393		0.409
b1	0.61		0.88	0.024		0.034
b2	1.23		1.32	0.048		0.051
C	4.40		4.60	0.173		0.181
c1	0.49		0.70	0.019		0.027
c2	2.40		2.72	0.094		0.107
e	4.80		5.40	0.189		0.212
F	6.20		6.60	0.244		0.259
L	2.65		2.95	0.104		0.116
l2	1.14		1.70	0.044		0.066
l4	15.80	16.40	16.80	0.622	0.645	0.661
M		2.60			0.102	
Øl	3.75		3.85	0.147		0.151

2.3 DPAK package information

- Epoxy meets UL94, V0

Figure 13. DPAK package outline

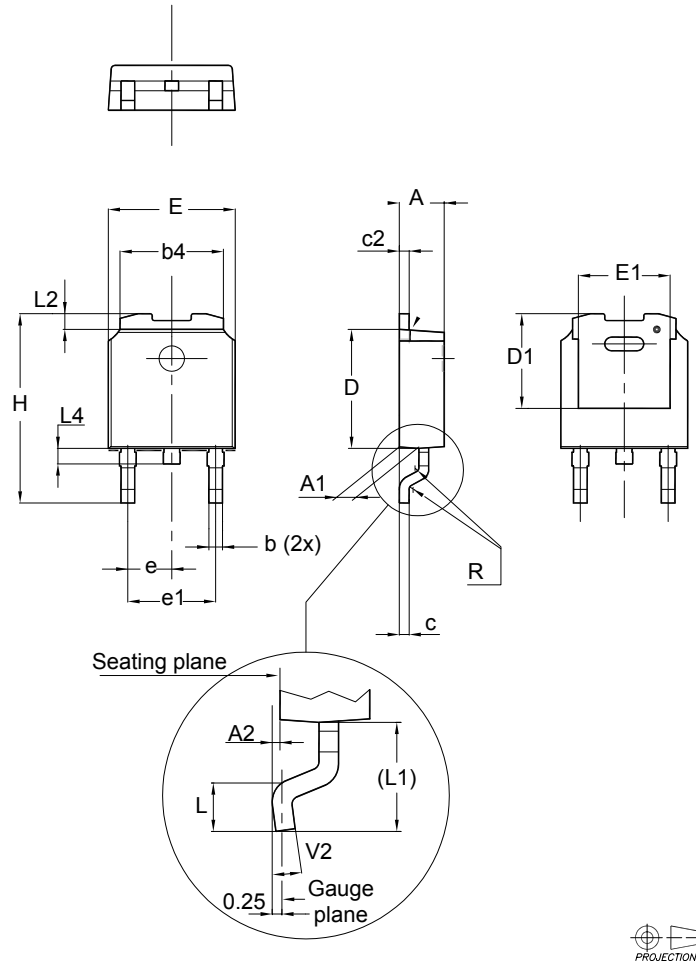
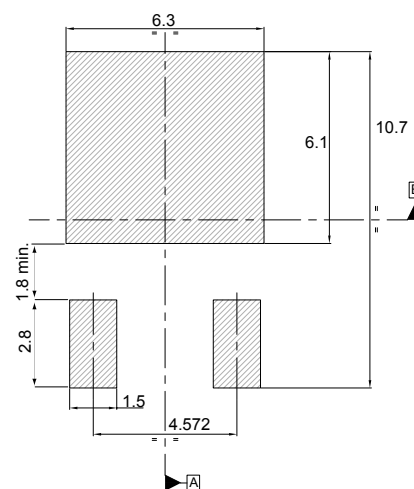

Table 7. DPAK mechanical data

Dim.	Dimensions					
	Millimeters			Inches ⁽¹⁾		
	Min.	Typ.	Max.	Min.	Typ.	Max.
A	2.20		2.40	0.087		0.094
A1	0.90		1.10	0.035		0.043
A2	0.03		0.23	0.001		0.009
b	0.64		0.90	0.025		0.035
b4	5.20		5.40	0.205		0.213
c	0.45		0.60	0.018		0.024
c2	0.48		0.60	0.019		0.024
D	6.00		6.20	0.236		0.244
D1	4.95	5.10	5.25	0.195	0.201	0.207
E	6.40		6.60	0.252		0.260
E1	4.60	4.70	4.80	0.181	0.185	0.189
e	2.159	2.286	2.413	0.085	0.090	0.095
e1	4.445	4.572	4.699	0.175	0.180	0.185
H	9.35		10.10	0.368		0.398
L	1.00		1.50	0.039		0.059
(L1)	2.60	2.80	3.00	0.102	0.110	0.118
L2	0.65	0.80	0.95	0.026	0.031	0.037
L4	0.60		1.00	0.024		0.039
R		0.20			0.008	
V2	0°		8°	0°		8°

1. Inches dimensions given for reference only

Figure 14. DPAK recommended footprint (dimensions are in mm)



The device must be positioned within $\Phi 0.05 \text{ A B}$

3 Ordering information

Table 8. Ordering information

Order code	Marking	Package	Weight	Base qty.	Delivery mode
STPSC4H065D	STPSC4H065D	TO-220AC	1.86 g	50	Tube
STPSC4H065DI	STPSC 4H065DI	TO-220AC Ins.	2.12 g	50	Tube
STPSC4H065B-TR	STPSC 4H065	DPAK	0.32 g	2500	Tape and reel

Revision history

Table 9. Document revision history

Date	Version	Changes
31-Aug-2012	1	First issue.
10-Oct-2012	2	Added Max. value to Table 3.
07-Nov-2013	3	Updated Figure 1, Figure 2, Figure 13, Figure 14, and Table 8.
07-Jan-2014	4	Added TO-220AC Ins. package.
15-Jul-2015	5	Updated Table 9.
09-Jan-2020	6	Updated Features.

IMPORTANT NOTICE – PLEASE READ CAREFULLY

STMicroelectronics NV and its subsidiaries (“ST”) reserve the right to make changes, corrections, enhancements, modifications, and improvements to ST products and/or to this document at any time without notice. Purchasers should obtain the latest relevant information on ST products before placing orders. ST products are sold pursuant to ST’s terms and conditions of sale in place at the time of order acknowledgement.

Purchasers are solely responsible for the choice, selection, and use of ST products and ST assumes no liability for application assistance or the design of Purchasers’ products.

No license, express or implied, to any intellectual property right is granted by ST herein.

Resale of ST products with provisions different from the information set forth herein shall void any warranty granted by ST for such product.

ST and the ST logo are trademarks of ST. For additional information about ST trademarks, please refer to www.st.com/trademarks. All other product or service names are the property of their respective owners.

Information in this document supersedes and replaces information previously supplied in any prior versions of this document.

© 2020 STMicroelectronics – All rights reserved