

**Stecklänge / mating length**

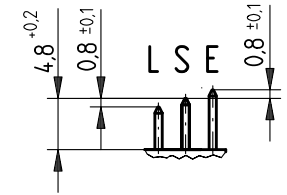

E = early mate, late break / voreilend  
 S = standard  
 L = late mate, early break / nacheilend

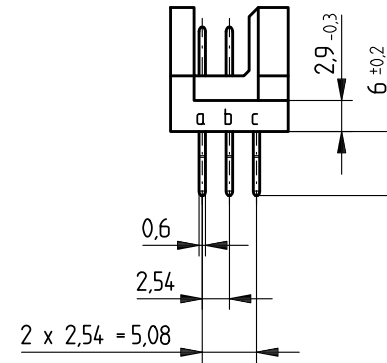
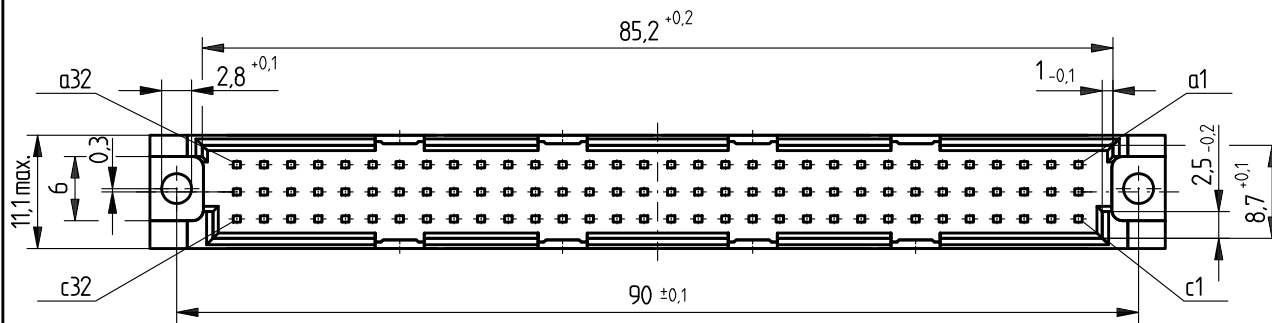

**Bestückungsplan / contact layout**

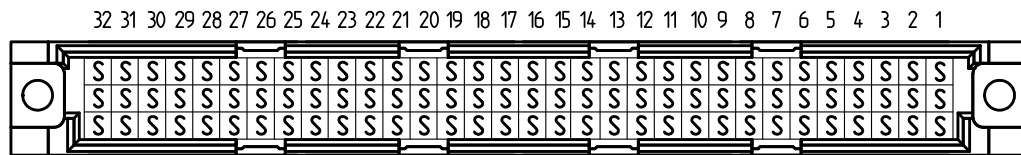

**Leiterplatten-Lochbild / PCB drillhole pattern**

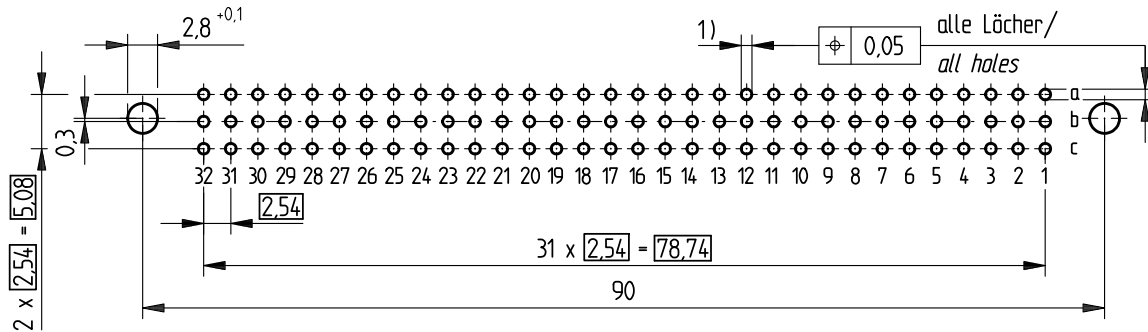

Elastische Einpresszone / compliant pressfit zone

Isolierwerkstoff / housing material : PBT GF30

Bauart 4 / type 4

Anforderungsstufe 2 = 400 Steckzyklen / performance class 2 = 400 mating cycles

Fehlende Masse und Angaben nach IEC 60 603-2 / DIN EN 60 603-2

Missing information and dimensions per IEC 60 603-2 / DIN EN 60 603-2

Schichtaufbau im metallisierten Loch siehe Zeichnung 164062 / Nr. 6



diameter of drilled hole see drawing 164062 / No. 6

1)  $\phi 1,0 \pm 0,09$  Durchmesser des metallisierten Loches

$\phi 1,0 \pm 0,06$  Diameter of finished plated-through hole

Bedruckung siehe Zeichnung 294905

Marking see drawing 294905

Information:  All rights reserved. Only for information. To insure that this is the latest version of this drawing, please contact one of the ERNI companies before using.	Tolerances  All Dimensions in mm	Scale 2:1
	Subject to modification without prior notice. Drawing will not be updated.	Designation <b>Messerleiste R 96 EE</b> <b>Male Connector R 96 Pressfit</b>
 www.ERNI.com	234712	
a Index	09.04.2008 Date	H:000654-36.SZA STVR

Consider protection memo from DIN 34