

## 20A, 100V - 200V Trench Schottky Rectifier

### FEATURES

- Patented Trench Schottky technology
- Excellent high temperature stability
- Low forward voltage
- Low power loss/ High efficiency
- High forward surge capability
- RoHS Compliant
- Halogen-free according to IEC 61249-2-21

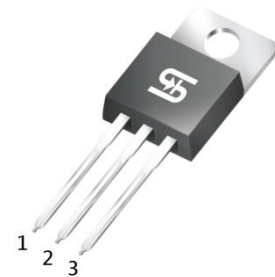
### APPLICATIONS

- Switching mode power supply (SMPS)
- Adapters
- DC to DC converters

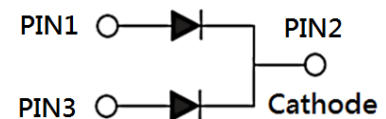
### MECHANICAL DATA

- Case: TO-220AB
- Molding compound meets UL 94V-0 flammability rating
- Terminal: Matte tin plated leads, solderable per J-STD-002
- Mounting torque: 0.56 N·m maximum
- Meet JESD 201 class 1A whisker test
- Polarity: As marked
- Weight: 1.88g (approximately)

KEY PARAMETERS		
PARAMETER	VALUE	UNIT
$I_F$	20	A
$V_{RRM}$	100 - 200	V
$I_{FSM}$	150	A
$T_{JMAX}$	150	°C
Package	TO-220AB	
Configuration	Dual dies	



TO-220AB



ABSOLUTE MAXIMUM RATINGS ( $T_A = 25^\circ\text{C}$ unless otherwise noted)						
PARAMETER	SYMBOL	TST20H 100CW	TST20H 120CW	TST20H 150CW	TST20H 200CW	UNIT
Marking code on the device		TST20H 100CW	TST20H 120CW	TST20H 150CW	TST20H 200CW	
Repetitive peak reverse voltage	$V_{RRM}$	100	120	150	200	V
Reverse voltage, total rms value	$V_{R(RMS)}$	70	84	105	140	V
Forward current	$I_F$	20				A
Surge peak forward current, 8.3ms single half sine wave superimposed on rated load	$I_{FSM}$	150				A
Critical rate of rise of off-state voltage	dv/dt	10,000				V/ $\mu\text{s}$
Junction temperature	$T_J$	-55 to +150				°C
Storage temperature	$T_{STG}$	-55 to +150				°C

<b>THERMAL PERFORMANCE</b>			
<b>PARAMETER</b>	<b>SYMBOL</b>	<b>TYP</b>	<b>UNIT</b>
Junction-to-case thermal resistance	$R_{\theta JC}$	2.8	°C/W

<b>ELECTRICAL SPECIFICATIONS</b> ( $T_A = 25^\circ\text{C}$ unless otherwise noted)						
<b>PARAMETER</b>		<b>CONDITIONS</b>	<b>SYMBOL</b>	<b>TYP</b>	<b>MAX</b>	<b>UNIT</b>
Forward voltage per diode <sup>(1)</sup>	TST20H100CW	$I_F = 5\text{A}, T_J = 25^\circ\text{C}$	$V_F$	0.57	-	V
	TST20H120CW			0.62	-	V
	TST20H150CW			0.72	-	V
	TST20H200CW			0.77	-	V
	TST20H100CW	$I_F = 10\text{A}, T_J = 25^\circ\text{C}$		0.67	0.79	V
	TST20H120CW			0.78	0.89	V
	TST20H150CW			0.81	0.90	V
	TST20H200CW			0.83	0.93	V
	TST20H100CW	$I_F = 5\text{A}, T_J = 125^\circ\text{C}$		0.50	-	V
	TST20H120CW			0.53	-	V
	TST20H150CW			0.58	-	V
	TST20H200CW			0.62	-	V
	TST20H100CW	$I_F = 10\text{A}, T_J = 125^\circ\text{C}$		0.59	0.68	V
	TST20H120CW			0.63	0.72	V
	TST20H150CW			0.66	0.75	V
	TST20H200CW			0.68	0.78	V
Reverse current @ rated $V_R$ per diode <sup>(2)</sup>	TST20H100CW	$T_J = 25^\circ\text{C}$	$I_R$	-	200	$\mu\text{A}$
	TST20H120CW			-	100	$\mu\text{A}$
	TST20H150CW			-	25	mA
	TST20H200CW			-	30	mA
	TST20H100CW	$T_J = 125^\circ\text{C}$		-	15	mA
	TST20H120CW			-	15	mA

**Notes:**

1. Pulse test with PW = 0.3ms
2. Pulse test with PW = 30ms

<b>ORDERING INFORMATION</b>		
<b>ORDERING CODE<sup>(1)</sup></b>	<b>PACKAGE</b>	<b>PACKING</b>
TST20HxCW	TO-220AB	50 / Tube

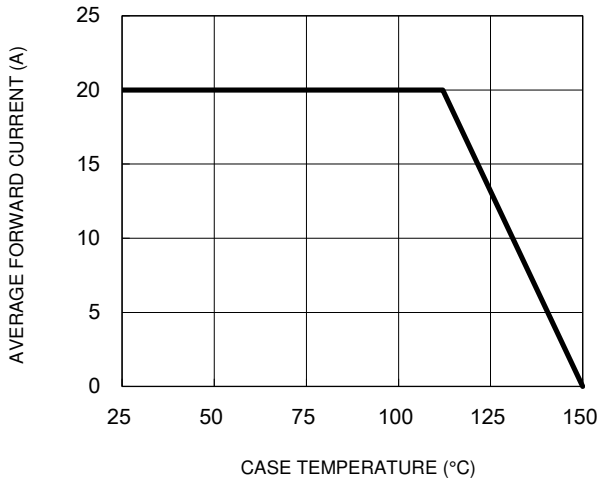
**Notes:**

1. "x" defines voltage from 100V(TST20H100CW) to 200V(TST20H200CW)

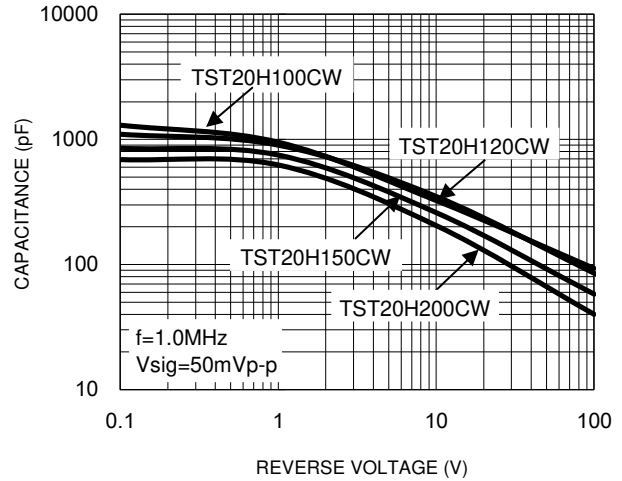
**CHARACTERISTICS CURVES**

( $T_A = 25^\circ\text{C}$  unless otherwise noted)

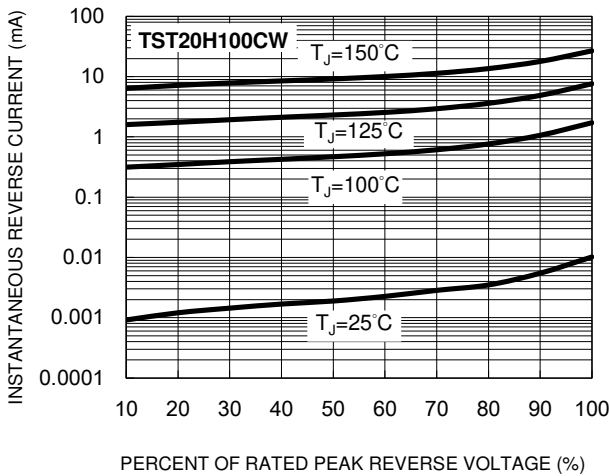
**Fig.1 Forward Current Derating Curve**



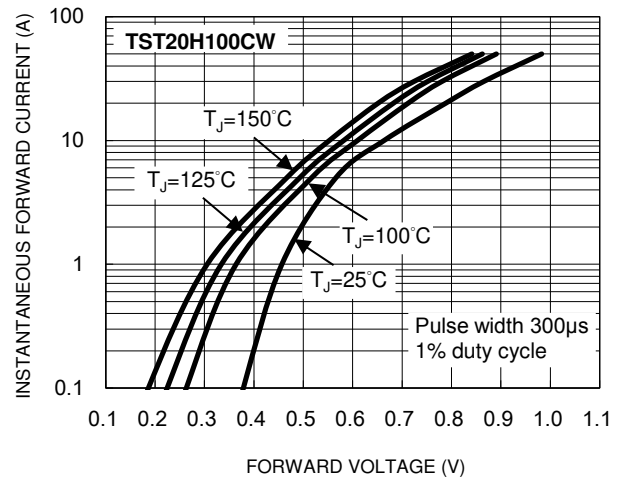
**Fig.2 Typical Junction Capacitance**



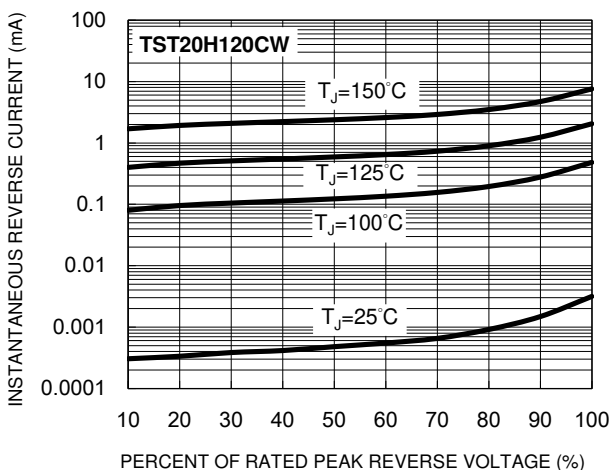
**Fig.3 Typical Reverse Characteristics**



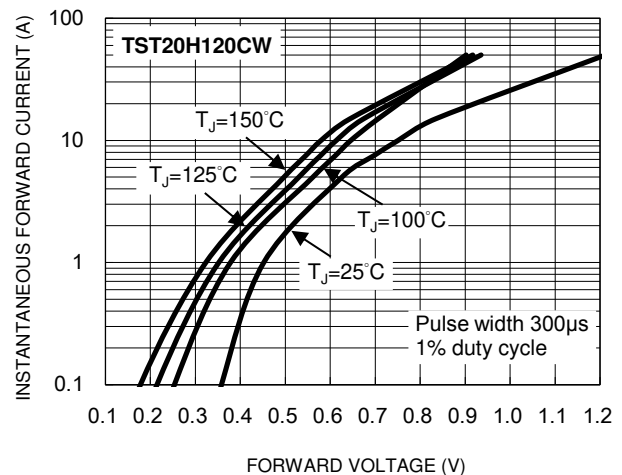
**Fig.4 Typical Forward Characteristics**



**Fig.5 Typical Reverse Characteristics**



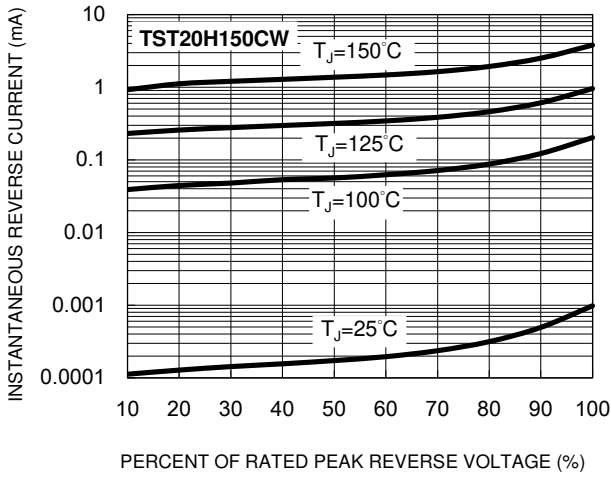
**Fig.6 Typical Forward Characteristics**



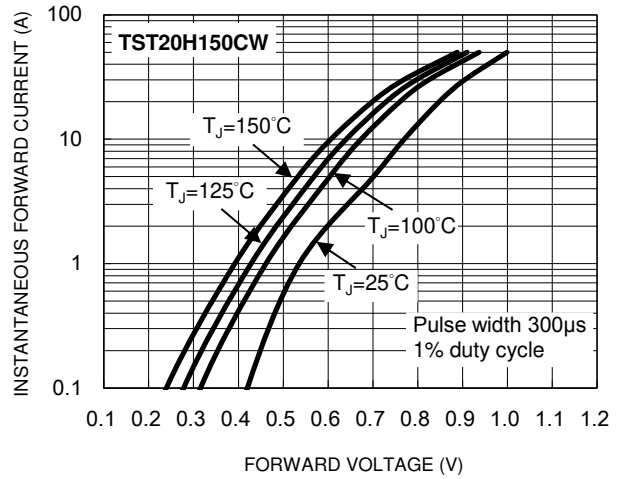
**CHARACTERISTICS CURVES**

( $T_A = 25^\circ\text{C}$  unless otherwise noted)

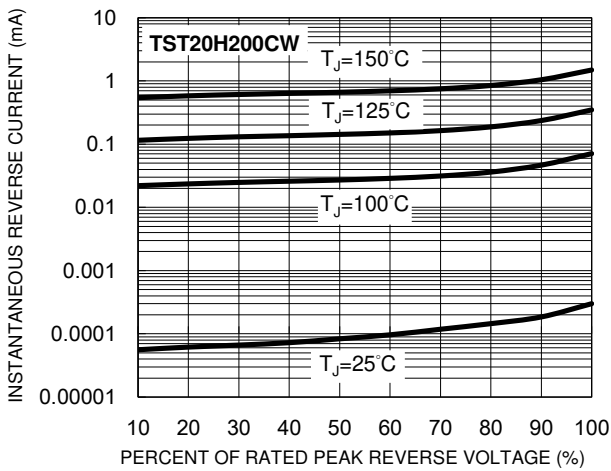
**Fig.7 Typical Reverse Characteristics**



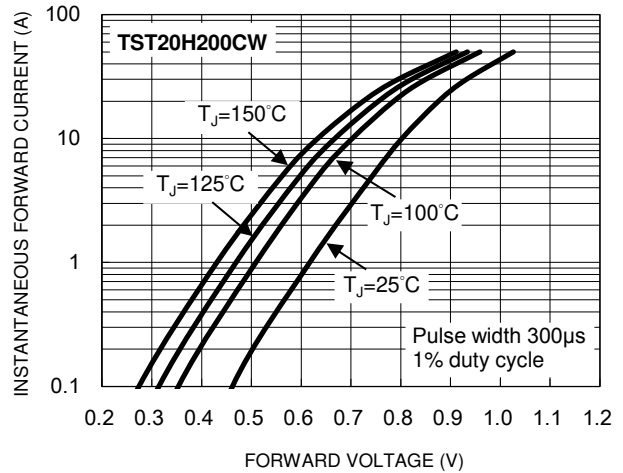
**Fig.8 Typical Forward Characteristics**



**Fig.9 Typical Reverse Characteristics**

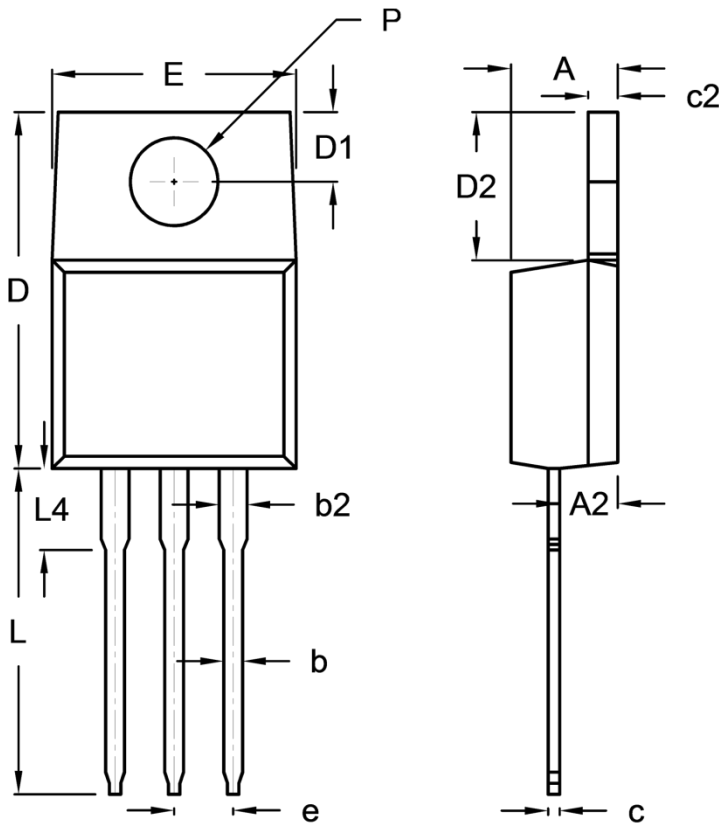


**Fig.10 Typical Forward Characteristics**



**PACKAGE OUTLINE DIMENSIONS**

TO-220AB



DIM.	Unit (mm)		Unit (inch)	
	Min.	Max.	Min.	Max.
A	4.42	4.76	0.174	0.187
A2	2.20	2.80	0.087	0.110
b	0.68	0.94	0.027	0.037
b2	0.95	1.45	0.037	0.057
c	0.35	0.64	0.014	0.025
c2	1.14	1.40	0.045	0.055
D	14.60	16.00	0.575	0.630
D1	2.54	3.44	0.100	0.135
D2	5.84	6.86	0.230	0.270
E	-	10.50	-	0.413
e	2.41	2.67	0.095	0.105
L	13.19	14.79	0.519	0.582
L4	2.80	4.20	0.110	0.165
P	3.54	4.00	0.139	0.157

**MARKING DIAGRAM**



- P/N = Marking Code
- G = Green Compound
- YWW = Date Code
- F = Factory Code

## **Notice**

Specifications of the products displayed herein are subject to change without notice. TSC or anyone on its behalf assumes no responsibility or liability for any errors or inaccuracies.

Purchasers are solely responsible for the choice, selection, and use of TSC products and TSC assumes no liability for application assistance or the design of Purchasers' products.

Information contained herein is intended to provide a product description only. No license, express or implied, to any intellectual property rights is granted by this document. Except as provided in TSC's terms and conditions of sale for such products, TSC assumes no liability whatsoever, and disclaims any express or implied warranty, relating to sale and/or use of TSC products including liability or warranties relating to fitness for a particular purpose, merchantability, or infringement of any patent, copyright, or other intellectual property right.

The products shown herein are not designed for use in medical, life-saving, or life-sustaining applications. Customers using or selling these products for use in such applications do so at their own risk and agree to fully indemnify TSC for any damages resulting from such improper use or sale.