

# Quad 2-Input OR Gate

## MM74HCT32

### General Description

The MM74HCT32 is a logic function fabricated by using advanced silicon-gate CMOS technology, which provides the inherent benefits of CMOS — low quiescent power and wide power supply range. This device is input and output characteristic and pin-out compatible with standard 74LS logic families. All inputs are protected from static discharge damage by internal diodes to  $V_{CC}$  and ground.

MM74HCT devices are intended to interface between TTL and NMOS components and standard CMOS devices. These parts are also plug-in replacements for LS-TTL devices and can be used to reduce power consumption in existing designs.

### Features

- TTL, LS Pin-out and Threshold Compatible
- Fast Switching:  $t_{PLH}$ ,  $t_{PHL}$  = 10 ns (Typ.)
- Low Power: 10  $\mu$ W at DC
- High Fan-out, 10 LS-TTL Loads
- These Devices are Pb-Free, Halide Free and are RoHS Compliant

### Connection Diagram

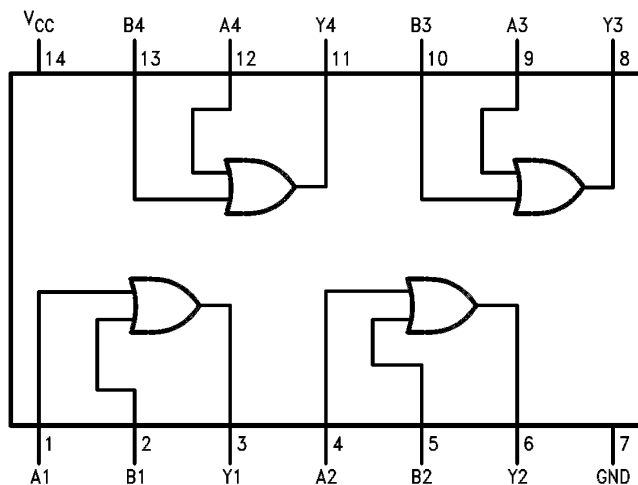

Figure 1. Pin Assignments for SOIC and TSSOP

### Logic Diagram

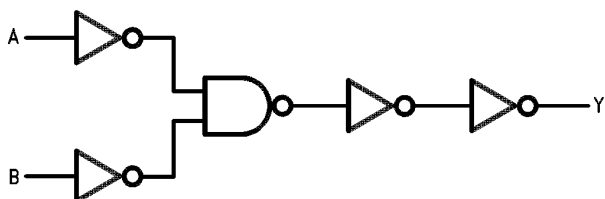
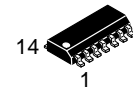
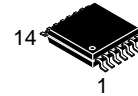

Figure 2. Logic Diagram



SOIC-14 NB  
CASE 751A-03



TSSOP-14 WB  
CASE 948G

### MARKING DIAGRAM

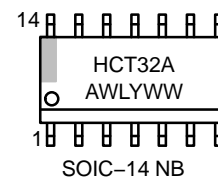

SOIC-14 NB

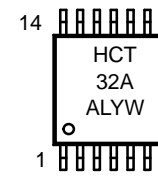

TSSOP-14

HCT32A = Specific Device Code  
A = Assembly Location  
WL, L = Wafer Lot  
Y = Year  
WW, W = Work Week

### ORDERING INFORMATION

See detailed ordering and shipping information on page 3 of this data sheet.

# MM74HCT32

## ABSOLUTE MAXIMUM RATINGS (Note 1)

Symbol	Parameter		Rating
$V_{CC}$	Supply Voltage		-0.5 to +7.0 V
$V_{IN}$	DC Input Voltage		-0.5 to $V_{CC} + 0.5$ V
$V_{OUT}$	DC Output Voltage		-0.5 to $V_{CC} + 0.5$ V
$I_{IK}, I_{OK}$	Clamp Diode Current		$\pm 20$ mA
$I_{OUT}$	DC Output Current, per Pin		$\pm 25$ mA
$I_{CC}$	DC $V_{CC}$ or GND Current, per Pin		$\pm 50$ mA
$T_{STG}$	Storage Temperature Range		-65°C to +150°C
$P_D$	Power Dissipation	S.O. Package Only	500 mW
$T_L$	Lead Temperature (Soldering 10 Seconds)		260°C

Stresses exceeding those listed in the Maximum Ratings table may damage the device. If any of these limits are exceeded, device functionality should not be assumed, damage may occur and reliability may be affected.

1. Unless otherwise specified all voltages are referenced to ground.

## RECOMMENDED OPERATING CONDITIONS

Symbol	Parameter	Min	Max	Unit
$V_{CC}$	Supply Voltage	4.5	5.5	V
$V_{IN}, V_{OUT}$	DC Input or Output Voltage	0	$V_{CC}$	V
$T_A$	Operating Temperature Range	-40	+85	°C
$t_r, t_f$	Input Rise or Fall Times	-	500	ns

Functional operation above the stresses listed in the Recommended Operating Ranges is not implied. Extended exposure to stresses beyond the Recommended Operating Ranges limits may affect device reliability.

## DC CHARACTERISTICS ( $V_{CC} = 5$ V $\pm 10\%$ (unless otherwise specified))

Symbol	Parameter	Conditions	$T_A = 25^\circ\text{C}$		$T_A = -40^\circ\text{C to } 85^\circ\text{C}$		Unit
			Typ	Guaranteed Limits			
$V_{IH}$	Minimum HIGH Level Input Voltage		-	2.0	2.0		V
$V_{IL}$	Maximum LOW Level Input Voltage		-	0.8	0.8		V
$V_{OH}$	Minimum HIGH Level Output Voltage	$V_{IN} = V_{IH}$ or $V_{IL}$ , $ I_{OUT}  = 20 \mu\text{A}$	$V_{CC}$	$V_{CC} - 0.1$	$V_{CC} - 0.1$		V
		$V_{IN} = V_{IH}$ or $V_{IL}$ , $ I_{OUT}  = 4.0$ mA, $V_{CC} = 4.5$ V	4.2	3.98	3.84		
		$V_{IN} = V_{IH}$ or $V_{IL}$ , $ I_{OUT}  = 4.8$ mA, $V_{CC} = 5.5$ V	5.2	4.98	4.84		
$V_{OL}$	Maximum LOW Level Voltage	$V_{IN} = V_{IH}$ , $ I_{OUT}  = 20 \mu\text{A}$	0	0.1	0.1		V
		$V_{IN} = V_{IH}$ , $ I_{OUT}  = 4.0$ mA, $V_{CC} = 4.5$ V	0.2	0.26	0.33		
		$V_{IN} = V_{IH}$ , $ I_{OUT}  = 4.8$ mA, $V_{CC} = 5.5$ V	0.2	0.26	0.33		
$I_{IN}$	Maximum Input Current	$V_{IN} = V_{CC}$ or GND, $V_{IH}$ or $V_{IL}$	-	$\pm 0.1$	$\pm 1.0$		$\mu\text{A}$
$I_{CC}$	Maximum Quiescent Supply Current	$V_{IN} = V_{CC}$ or GND, $I_{OUT} = 0 \mu\text{A}$	-	2.0	20		$\mu\text{A}$
		$V_{IN} = 2.4$ V or 0.5 V (Note 2)	-	1.2	1.4		mA

2. This is measured per input with all other inputs held at  $V_{CC}$  or ground.

## MM74HCT32

**AC CHARACTERISTICS** ( $V_{CC} = 5.0\text{ V}$ ,  $t_r = t_f = 6\text{ ns}$ ,  $C_L = 15\text{ pF}$ ,  $T_A = 25^\circ\text{C}$  (unless otherwise noted))

Symbol	Parameter	Conditions	Typ	Guaranteed Limit	Unit
$t_{PLH}$ , $t_{PHL}$	Maximum Propagation Delay		10	–	ns

**AC CHARACTERISTICS** ( $V_{CC} = 5.0\text{ V} \pm 10\%$ ,  $t_r = t_f = 6\text{ ns}$ ,  $C_L = 15\text{ pF}$  (unless otherwise noted))

Symbol	Parameter	Conditions	$T_A = 25^\circ\text{C}$		$T_A = -40^\circ\text{C to } 85^\circ\text{C}$	Unit
			Typ	Guaranteed Limits		
$t_{PLH}$ , $t_{PHL}$	Maximum Propagation Delay		12	20	25	ns
$t_{THL}$ , $t_{TLH}$	Maximum Output Rise & Fall Time		8	15	19	ns
$C_{PD}$	Power Dissipation Capacitance	(Note 3)	48	–	–	pF
$C_{IN}$	Maximum Input Capacitance		5	10	10	pF

3.  $C_{PD}$  determines the no load dynamic power consumption,  $P_D = C_{PD} V_{CC}^2 f + I_{CC} V_{CC}$ , and the no load dynamic current consumption,  $I_S = C_{PD} V_{CC} f + I_{CC}$ .

### ORDERING INFORMATION

Part Number	Package	Shipping†
MM74HCT32M	SOIC–14, Case 751A–03 (Pb–Free, Halide–Free)	55 Units / Tube
MM74HCT32MX	SOIC–14, Case 751A–03 (Pb–Free, Halide–Free)	2500 Units / Tape & Reel
MM74HCT32MTCX	TSSOP–14, Case 948G–01 (Pb–Free, Halide Free)	2500 Units / Tape & Reel

†For information on tape and reel specifications, including part orientation and tape sizes, please refer to our Tape and Reel Packaging Specifications Brochure, BRD8011/D.

# MECHANICAL CASE OUTLINE PACKAGE DIMENSIONS

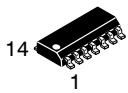

SCALE 1:1

SOIC-14 NB  
CASE 751A-03  
ISSUE L

DATE 03 FEB 2016

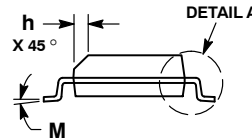
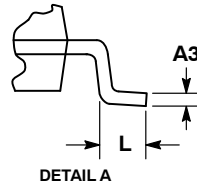
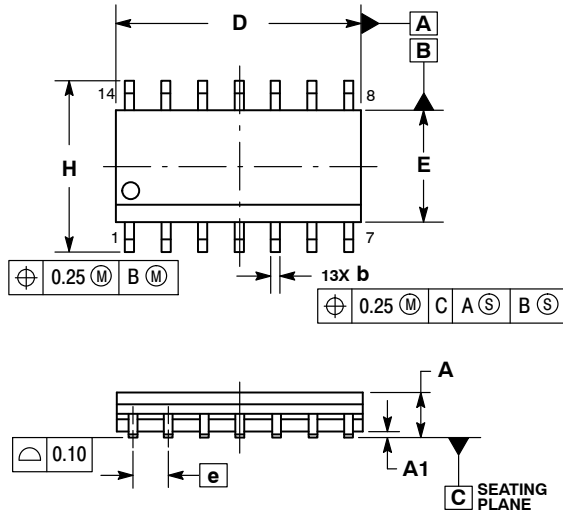

NOTES:

1. DIMENSIONING AND TOLERANCING PER ASME Y14.5M, 1994.
2. CONTROLLING DIMENSION: MILLIMETERS.
3. DIMENSION b DOES NOT INCLUDE DAMBAR PROTRUSION. ALLOWABLE PROTRUSION SHALL BE 0.13 TOTAL IN EXCESS OF AT MAXIMUM MATERIAL CONDITION.
4. DIMENSIONS D AND E DO NOT INCLUDE MOLD PROTRUSIONS.
5. MAXIMUM MOLD PROTRUSION 0.15 PER SIDE.

DIM	MILLIMETERS		INCHES	
	MIN	MAX	MIN	MAX
A	1.35	1.75	0.054	0.068
A1	0.10	0.25	0.004	0.010
A3	0.19	0.25	0.008	0.010
b	0.35	0.49	0.014	0.019
D	8.55	8.75	0.337	0.344
E	3.80	4.00	0.150	0.157
e	1.27 BSC		0.050 BSC	
H	5.80	6.20	0.228	0.244
h	0.25	0.50	0.010	0.019
L	0.40	1.25	0.016	0.049
M	0°	7°	0°	7°

SOLDERING FOOTPRINT\*

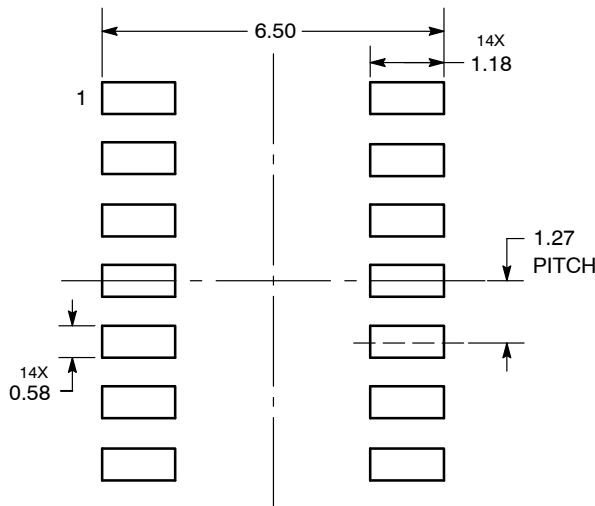

DIMENSIONS: MILLIMETERS

\*For additional information on our Pb-Free strategy and soldering details, please download the ON Semiconductor Soldering and Mounting Techniques Reference Manual, SOLDERRM/D.

GENERIC MARKING DIAGRAM\*

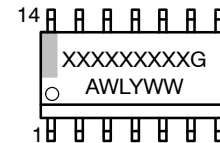

- XXXXXX = Specific Device Code
- A = Assembly Location
- WL = Wafer Lot
- Y = Year
- WW = Work Week
- G = Pb-Free Package

\*This information is generic. Please refer to device data sheet for actual part marking. Pb-Free indicator, "G" or microdot "▪", may or may not be present. Some products may not follow the Generic Marking.

STYLES ON PAGE 2

DOCUMENT NUMBER:	98ASB42565B	Electronic versions are uncontrolled except when accessed directly from the Document Repository. Printed versions are uncontrolled except when stamped "CONTROLLED COPY" in red.
DESCRIPTION:	SOIC-14 NB	PAGE 1 OF 2

onsemi and onsemi are trademarks of Semiconductor Components Industries, LLC dba onsemi or its subsidiaries in the United States and/or other countries. onsemi reserves the right to make changes without further notice to any products herein. onsemi makes no warranty, representation or guarantee regarding the suitability of its products for any particular purpose, nor does onsemi assume any liability arising out of the application or use of any product or circuit, and specifically disclaims any and all liability, including without limitation special, consequential or incidental damages. onsemi does not convey any license under its patent rights nor the rights of others.

**SOIC-14**  
**CASE 751A-03**  
**ISSUE L**

DATE 03 FEB 2016

STYLE 1:  
 PIN 1. COMMON CATHODE  
 2. ANODE/CATHODE  
 3. ANODE/CATHODE  
 4. NO CONNECTION  
 5. ANODE/CATHODE  
 6. NO CONNECTION  
 7. ANODE/CATHODE  
 8. ANODE/CATHODE  
 9. ANODE/CATHODE  
 10. NO CONNECTION  
 11. ANODE/CATHODE  
 12. ANODE/CATHODE  
 13. NO CONNECTION  
 14. COMMON ANODE

STYLE 2:  
 CANCELLED

STYLE 3:  
 PIN 1. NO CONNECTION  
 2. ANODE  
 3. ANODE  
 4. NO CONNECTION  
 5. ANODE  
 6. NO CONNECTION  
 7. ANODE  
 8. ANODE  
 9. ANODE  
 10. NO CONNECTION  
 11. ANODE  
 12. ANODE  
 13. NO CONNECTION  
 14. COMMON CATHODE

STYLE 4:  
 PIN 1. NO CONNECTION  
 2. CATHODE  
 3. CATHODE  
 4. NO CONNECTION  
 5. CATHODE  
 6. NO CONNECTION  
 7. CATHODE  
 8. CATHODE  
 9. CATHODE  
 10. NO CONNECTION  
 11. CATHODE  
 12. CATHODE  
 13. NO CONNECTION  
 14. COMMON ANODE

STYLE 5:  
 PIN 1. COMMON CATHODE  
 2. ANODE/CATHODE  
 3. ANODE/CATHODE  
 4. ANODE/CATHODE  
 5. ANODE/CATHODE  
 6. NO CONNECTION  
 7. COMMON ANODE  
 8. COMMON CATHODE  
 9. ANODE/CATHODE  
 10. ANODE/CATHODE  
 11. ANODE/CATHODE  
 12. ANODE/CATHODE  
 13. NO CONNECTION  
 14. COMMON ANODE

STYLE 6:  
 PIN 1. CATHODE  
 2. CATHODE  
 3. CATHODE  
 4. CATHODE  
 5. CATHODE  
 6. CATHODE  
 7. CATHODE  
 8. ANODE  
 9. ANODE  
 10. ANODE  
 11. ANODE  
 12. ANODE  
 13. ANODE  
 14. ANODE

STYLE 7:  
 PIN 1. ANODE/CATHODE  
 2. COMMON ANODE  
 3. COMMON CATHODE  
 4. ANODE/CATHODE  
 5. ANODE/CATHODE  
 6. ANODE/CATHODE  
 7. ANODE/CATHODE  
 8. ANODE/CATHODE  
 9. ANODE/CATHODE  
 10. ANODE/CATHODE  
 11. COMMON CATHODE  
 12. COMMON ANODE  
 13. ANODE/CATHODE  
 14. ANODE/CATHODE

STYLE 8:  
 PIN 1. COMMON CATHODE  
 2. ANODE/CATHODE  
 3. ANODE/CATHODE  
 4. NO CONNECTION  
 5. ANODE/CATHODE  
 6. ANODE/CATHODE  
 7. COMMON ANODE  
 8. COMMON ANODE  
 9. ANODE/CATHODE  
 10. ANODE/CATHODE  
 11. NO CONNECTION  
 12. ANODE/CATHODE  
 13. ANODE/CATHODE  
 14. COMMON CATHODE

<b>DOCUMENT NUMBER:</b>	<b>98ASB42565B</b>	Electronic versions are uncontrolled except when accessed directly from the Document Repository. Printed versions are uncontrolled except when stamped "CONTROLLED COPY" in red.
<b>DESCRIPTION:</b>	<b>SOIC-14 NB</b>	<b>PAGE 2 OF 2</b>

**onsemi** and **ONSEMI** are trademarks of Semiconductor Components Industries, LLC dba **onsemi** or its subsidiaries in the United States and/or other countries. **onsemi** reserves the right to make changes without further notice to any products herein. **onsemi** makes no warranty, representation or guarantee regarding the suitability of its products for any particular purpose, nor does **onsemi** assume any liability arising out of the application or use of any product or circuit, and specifically disclaims any and all liability, including without limitation special, consequential or incidental damages. **onsemi** does not convey any license under its patent rights nor the rights of others.

# MECHANICAL CASE OUTLINE PACKAGE DIMENSIONS

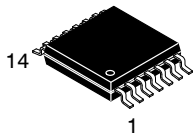

TSSOP-14 WB  
CASE 948G  
ISSUE C

DATE 17 FEB 2016

SCALE 2:1

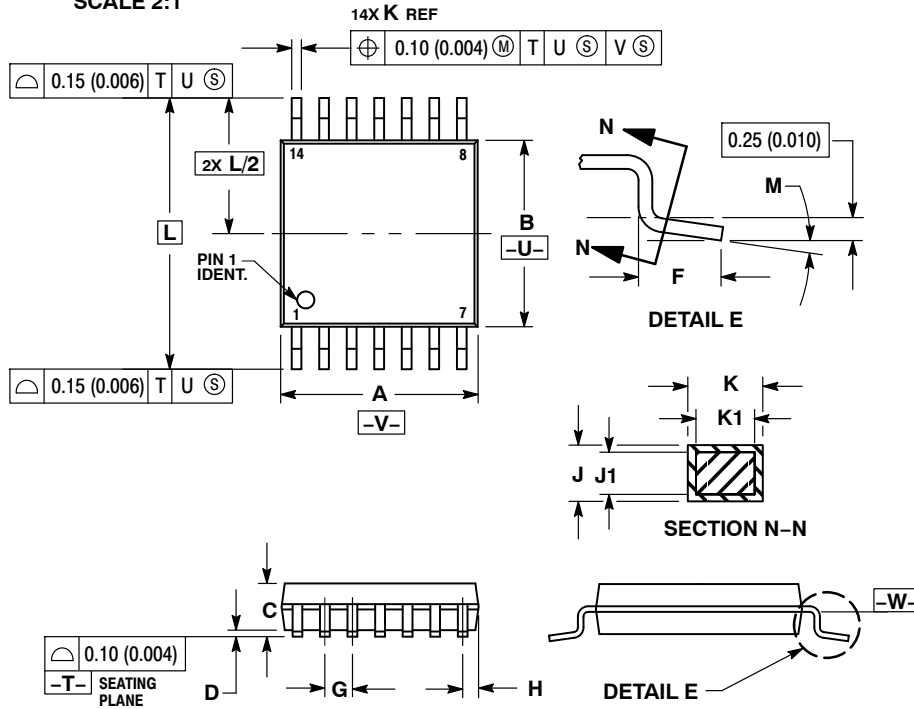

NOTES:

- DIMENSIONING AND TOLERANCING PER ANSI Y14.5M, 1982.
- CONTROLLING DIMENSION: MILLIMETER.
- DIMENSION A DOES NOT INCLUDE MOLD FLASH, PROTRUSIONS OR GATE BURRS. MOLD FLASH OR GATE BURRS SHALL NOT EXCEED 0.15 (0.006) PER SIDE.
- DIMENSION B DOES NOT INCLUDE INTERLEAD FLASH OR PROTRUSION. INTERLEAD FLASH OR PROTRUSION SHALL NOT EXCEED 0.25 (0.010) PER SIDE.
- DIMENSION K DOES NOT INCLUDE DAMBAR PROTRUSION. ALLOWABLE DAMBAR PROTRUSION SHALL BE 0.08 (0.003) TOTAL IN EXCESS OF THE K DIMENSION AT MAXIMUM MATERIAL CONDITION.
- TERMINAL NUMBERS ARE SHOWN FOR REFERENCE ONLY.
- DIMENSION A AND B ARE TO BE DETERMINED AT DATUM PLANE -W-.

DIM	MILLIMETERS		INCHES	
	MIN	MAX	MIN	MAX
A	4.90	5.10	0.193	0.200
B	4.30	4.50	0.169	0.177
C	---	1.20	---	0.047
D	0.05	0.15	0.002	0.006
F	0.50	0.75	0.020	0.030
G	0.65 BSC		0.026 BSC	
H	0.50	0.60	0.020	0.024
J	0.09	0.20	0.004	0.008
J1	0.09	0.16	0.004	0.006
K	0.19	0.30	0.007	0.012
K1	0.19	0.25	0.007	0.010
L	6.40 BSC		0.252 BSC	
M	0°	8°	0°	8°

GENERIC MARKING DIAGRAM\*

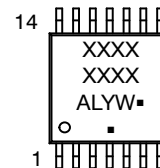

- A = Assembly Location
- L = Wafer Lot
- Y = Year
- W = Work Week
- = Pb-Free Package

(Note: Microdot may be in either location)

\*This information is generic. Please refer to device data sheet for actual part marking. Pb-Free indicator, "G" or microdot "▪", may or may not be present. Some products may not follow the Generic Marking.

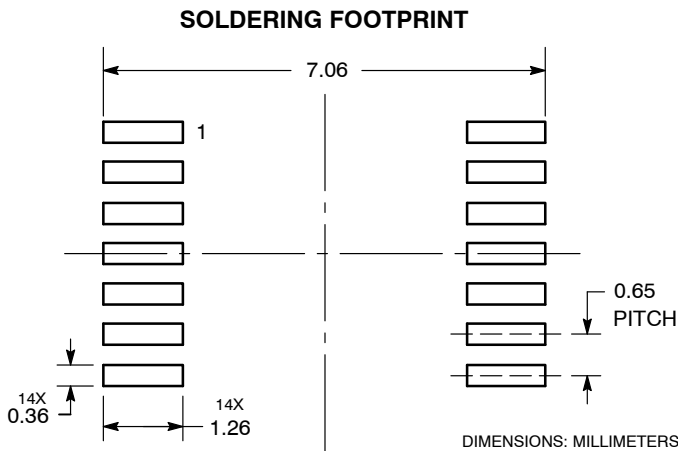

DOCUMENT NUMBER:	98ASH70246A	Electronic versions are uncontrolled except when accessed directly from the Document Repository. Printed versions are uncontrolled except when stamped "CONTROLLED COPY" in red.
DESCRIPTION:	TSSOP-14 WB	PAGE 1 OF 1

onsemi and onsemi are trademarks of Semiconductor Components Industries, LLC dba onsemi or its subsidiaries in the United States and/or other countries. onsemi reserves the right to make changes without further notice to any products herein. onsemi makes no warranty, representation or guarantee regarding the suitability of its products for any particular purpose, nor does onsemi assume any liability arising out of the application or use of any product or circuit, and specifically disclaims any and all liability, including without limitation special, consequential or incidental damages. onsemi does not convey any license under its patent rights nor the rights of others.

**onsemi**, **Onsemi**, and other names, marks, and brands are registered and/or common law trademarks of Semiconductor Components Industries, LLC dba "**onsemi**" or its affiliates and/or subsidiaries in the United States and/or other countries. **onsemi** owns the rights to a number of patents, trademarks, copyrights, trade secrets, and other intellectual property. A listing of **onsemi**'s product/patent coverage may be accessed at [www.onsemi.com/site/pdf/Patent-Marking.pdf](http://www.onsemi.com/site/pdf/Patent-Marking.pdf). **onsemi** reserves the right to make changes at any time to any products or information herein, without notice. The information herein is provided "as-is" and **onsemi** makes no warranty, representation or guarantee regarding the accuracy of the information, product features, availability, functionality, or suitability of its products for any particular purpose, nor does **onsemi** assume any liability arising out of the application or use of any product or circuit, and specifically disclaims any and all liability, including without limitation special, consequential or incidental damages. Buyer is responsible for its products and applications using **onsemi** products, including compliance with all laws, regulations and safety requirements or standards, regardless of any support or applications information provided by **onsemi**. "Typical" parameters which may be provided in **onsemi** data sheets and/or specifications can and do vary in different applications and actual performance may vary over time. All operating parameters, including "Typicals" must be validated for each customer application by customer's technical experts. **onsemi** does not convey any license under any of its intellectual property rights nor the rights of others. **onsemi** products are not designed, intended, or authorized for use as a critical component in life support systems or any FDA Class 3 medical devices or medical devices with a same or similar classification in a foreign jurisdiction or any devices intended for implantation in the human body. Should Buyer purchase or use **onsemi** products for any such unintended or unauthorized application, Buyer shall indemnify and hold **onsemi** and its officers, employees, subsidiaries, affiliates, and distributors harmless against all claims, costs, damages, and expenses, and reasonable attorney fees arising out of, directly or indirectly, any claim of personal injury or death associated with such unintended or unauthorized use, even if such claim alleges that **onsemi** was negligent regarding the design or manufacture of the part. **onsemi** is an Equal Opportunity/Affirmative Action Employer. This literature is subject to all applicable copyright laws and is not for resale in any manner.

## ADDITIONAL INFORMATION

### TECHNICAL PUBLICATIONS:

Technical Library: [www.onsemi.com/design/resources/technical-documentation](http://www.onsemi.com/design/resources/technical-documentation)  
onsemi Website: [www.onsemi.com](http://www.onsemi.com)

### ONLINE SUPPORT: [www.onsemi.com/support](http://www.onsemi.com/support)

For additional information, please contact your local Sales Representative at [www.onsemi.com/support/sales](http://www.onsemi.com/support/sales)