

ELV AND RoHS COMPLIANT

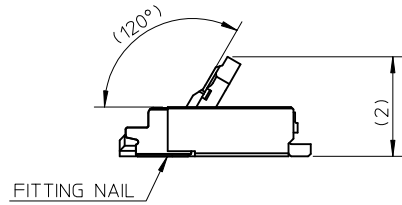

ACTUATOR OPEN

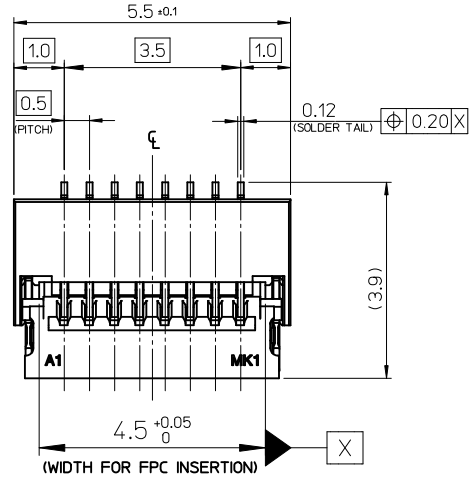
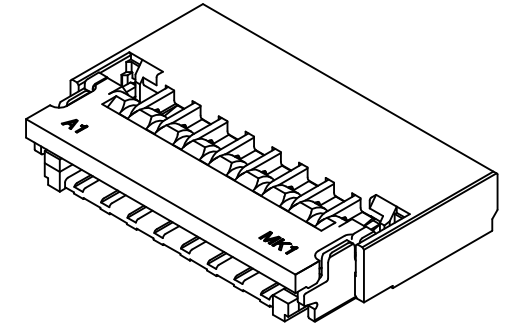

ISOMETRIC VIEW

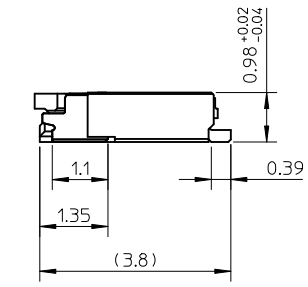
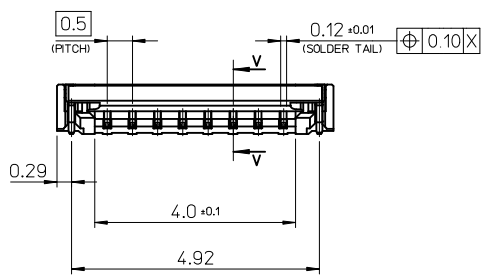

ACTUATOR CLOSE

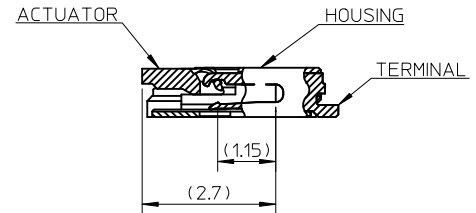

SECTION V-V  
SCALE 15:1

- NOTES**
- MATERIAL**
    - HOUSING : LCP, GLASS FILLED. UL94V-0, COLOR: NATURAL.
    - ACTUATOR : PPS, GLASS FILLED. UL94V-0, COLOR: BLACK.
    - TERMINAL : COPPER ALLOY
    - FITTING NAIL : COPPER ALLOY
  - FINISHES**
    - TERMINAL : SELECTIVE GOLD[Au] OVER NICKEL[Ni] PLATING.  
CONTACT : GOLD[Au] 0.1 MICROMETER MINIMUM  
NICKEL[Ni] 1-3 MICROMETER  
SOLDER : GOLD[Au] 0.05 MICROMETER MINIMUM  
NICKEL[Ni] 1-3 MICROMETER
    - FITTING NAIL : TIN[Sn] OVER NICKEL[Ni] PLATING.  
Tin[Sn] 15-3 MICROMETER.  
NICKEL[Ni] 1-3 MICROMETER
  - SOLDER TAILS AND FITTING NAILS**  
COPLANARITY IS TO BE 0.08 MAXIMUM.

- ACTUATOR IS CLOSE IN THE EMBOSSED PACKING
- PRODUCT SPECIFICATION : PS-104093-001
- PACKING SPECIFICATION : PK-104093-001

104093-0817	08
ORDER NO.	CKT

<b>NEW RELEASE</b> EC NO: KOR2011-0091 DRWN:HJEONG 2011/02/15 CHKD:KSKIM APPR:YUNSIKKIM 2011/04/28	QUALITY SYMBOLS	GENERAL TOLERANCES (UNLESS SPECIFIED)	DIMENSION STYLE	SCALE	DESIGN UNITS	THIRD ANGLE PROJECTION TITLE 0.5 FPC FRONTFLIP CONN(1.0H) HSG ASSY MOLEX INCORPORATED DOCUMENT NO. SD-104093-001 SHEET NO. 1 OF 3
	▽=0 ∇=0	mm    INCH 4 PLACES ± --- ± --- 3 PLACES ± --- ± --- 2 PLACES ± --- ± --- 1 PLACE ± 0.2 ± --- ANGULAR ± 1 °	MM ONLY	20:1	METRIC	
	REV	DRAFT WHERE APPLICABLE MUST REMAIN WITHIN DIMENSIONS	DRAWN BY: HJEONG    DATE: 2010/04/26 CHECKED BY: KSKIM    DATE: 2010/04/26 APPROVED BY: YUNSIKKIM    DATE: 2011/04/28 MATERIAL NO.    SEE TABLE			
	A		SIZE A3	THIS DRAWING CONTAINS INFORMATION THAT IS PROPRIETARY TO MOLEX INCORPORATED AND SHOULD NOT BE USED WITHOUT WRITTEN PERMISSION		

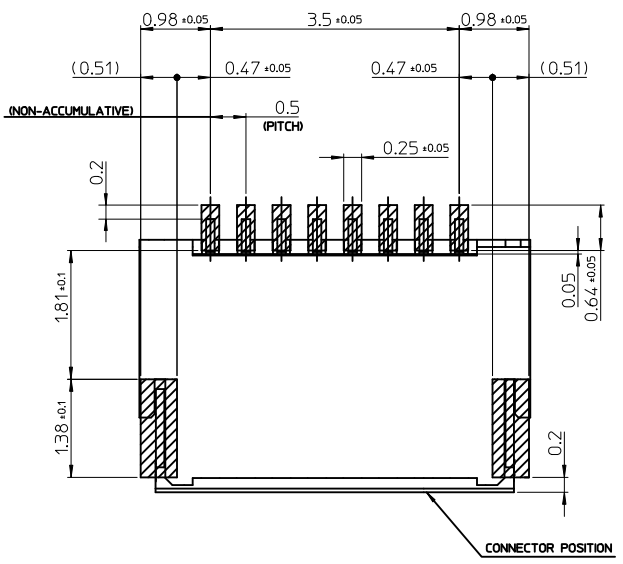

RECOMMENDED P.C.BOARD  
PATTERN DIMENSION(REF)

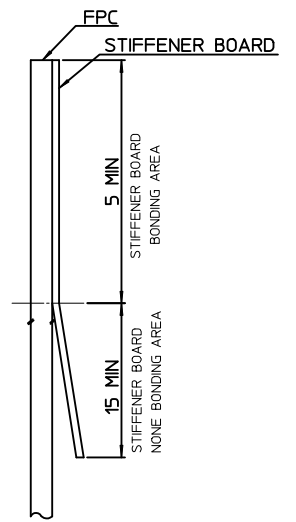
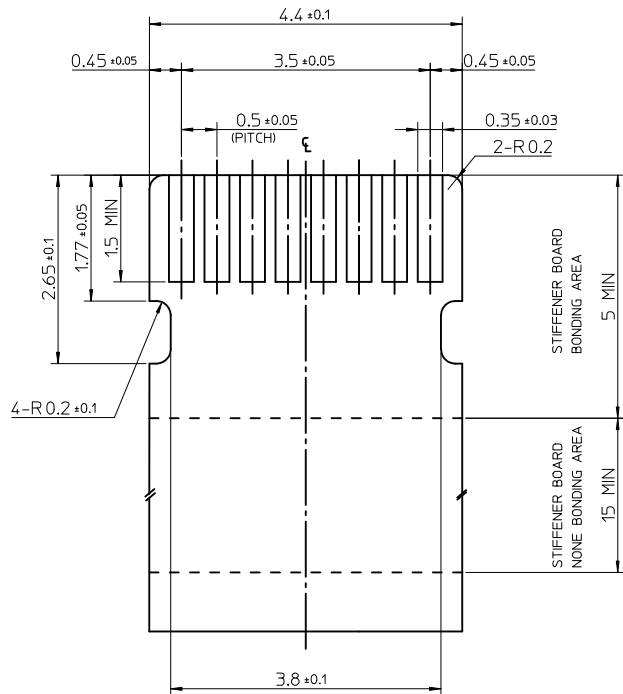

APPLICABLE FPC  
RECOMMENDED DIMENSION  
FPC THICKNESS :0.3±0.03

<b>NEW RELEASE</b> EC NO: KOR2011-0091 DRAWN: HJEONG 2011/02/15 CHKD: KSKIM APPR: YUNSIKKIM 2011/04/28	QUALITY SYMBOLS ▽=0 ▽=0	GENERAL TOLERANCES (UNLESS SPECIFIED) <table border="1"> <thead> <tr> <th></th> <th>mm</th> <th>INCH</th> </tr> </thead> <tbody> <tr> <td>4 PLACES</td> <td>± ---</td> <td>± ---</td> </tr> <tr> <td>3 PLACES</td> <td>± ---</td> <td>± ---</td> </tr> <tr> <td>2 PLACES</td> <td>± ---</td> <td>± ---</td> </tr> <tr> <td>1 PLACE</td> <td>± 0.2</td> <td>± ---</td> </tr> </tbody> </table>		mm	INCH	4 PLACES	± ---	± ---	3 PLACES	± ---	± ---	2 PLACES	± ---	± ---	1 PLACE	± 0.2	± ---	DIMENSION STYLE <b>MM ONLY</b>	SCALE <b>20:1</b>	DESIGN UNITS <b>METRIC</b>	THIRD ANGLE PROJECTION
		mm	INCH																		
	4 PLACES	± ---	± ---																		
	3 PLACES	± ---	± ---																		
2 PLACES	± ---	± ---																			
1 PLACE	± 0.2	± ---																			
DESCRIPTION <b>A</b>	DRAFT WHERE APPLICABLE MUST REMAIN WITHIN DIMENSIONS	DRAWN BY HJEONG	DATE 2010/04/26	TITLE <b>0.5 FPC FRONTFLIP CONN(H=1.0) HSG ASSY</b>																	
		CHECKED BY KSKIM	DATE 2010/04/26																		
		APPROVED BY YUNSIKKIM	DATE 2011/04/28																		
		MATERIAL NO. <b>SEE TABLE</b>	DOCUMENT NO. <b>SD-104093-001</b>																		
		THIS DRAWING CONTAINS INFORMATION THAT IS PROPRIETARY TO MOLEX INCORPORATED AND SHOULD NOT BE USED WITHOUT WRITTEN PERMISSION																			

ELV AND RoHS COMPLIANT  
CONFIDENTIAL

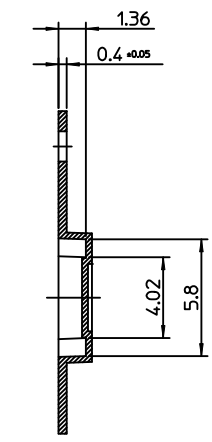
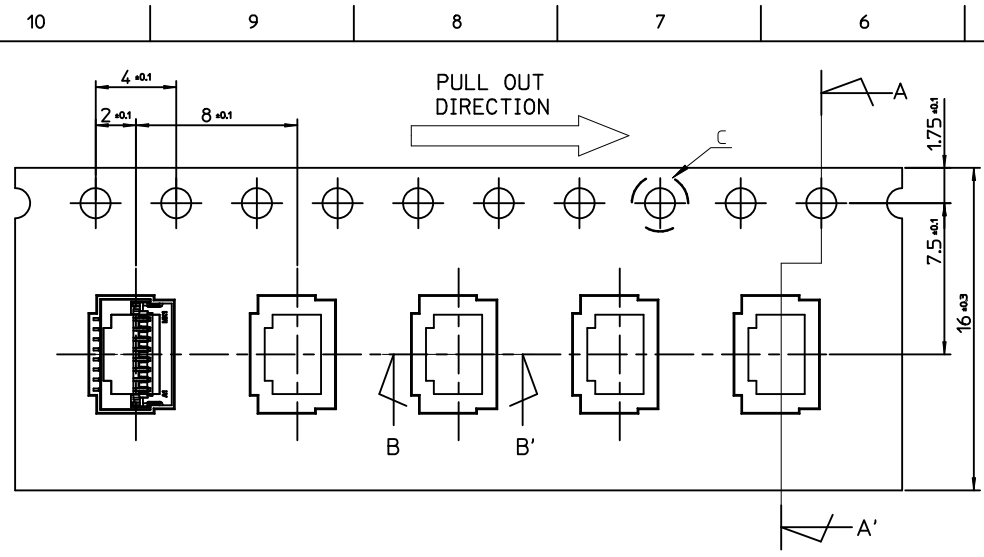

SECTION A-A'

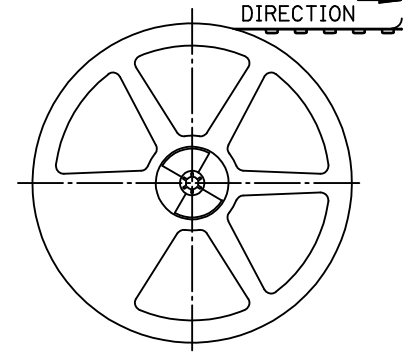

PLASTIC BOBBIN

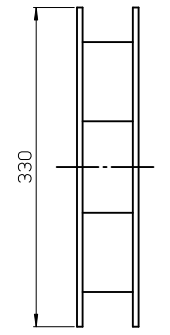

NOTES

1. QUANTITY OF CONNECTORS : 3000PCS/REEL
2. LEAD LENGTH

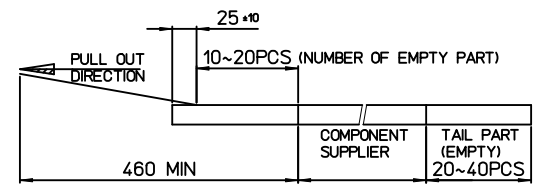

3. PEELING OFF FORCE OF COVER TAPE : 0.1N ~0.59N(10.2GF~60GF)  
(PEELING DIRECTION AS SHOW IN FOLLOW FIG.)  
PEELING OFF SPEED : 300mm/Min(Ref.)

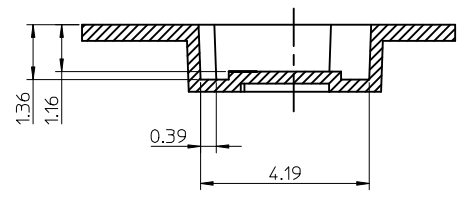

SECTION B-B'

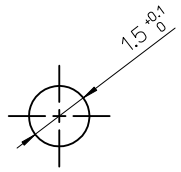

Detail C

[TABLE]

EMBOSS TAPE	16.0mm
	TAPE WIDTH

3	PLASTIC BOBBIN	P.S	WHITE
2	COVER TAPE	PET ANTISTATIC	13.3mm
1	CARRIER (EMBOSS) TAPE	PET ANTISTATIC	
NO.	DESCRIPTION	MATERIAL	REMARK

NEW RELEASE EC NO: KOR2011-0091 DRWN:HJEONG 2011/02/15 CHKD:KSKIM APPR:YUNSIKKIM 2011/04/28	DESCRIPTION	QUALITY SYMBOLS
	REV	

GENERAL TOLERANCES (UNLESS SPECIFIED)	mm	INCH
	4 PLACES ± ---	± ---
DRAFT WHERE APPLICABLE MUST REMAIN WITHIN DIMENSIONS	3 PLACES ± ---	± ---
	2 PLACES ± ---	± ---
ANGULAR ± 1°	1 PLACE ± 0.2	± ---
	SEE TABLE	

DIMENSION STYLE MM ONLY	
DRAWN BY HJEONG	DATE 2010/04/26
CHECKED BY KSKIM	DATE 2010/04/26
APPROVED BY YUNSIKKIM	DATE 2011/04/28
MATERIAL NO.	
SIZE A3	

SCALE 20:1	DESIGN UNITS METRIC	THIRD ANGLE PROJECTION
TITLE 0.5 FPC FRONTFLIP CONN(H=1.0)HSG ASSY		
MOLEX INCORPORATED		
DOCUMENT NO. SD-104093-001	SHEET NO. 3 OF 3	
THIS DRAWING CONTAINS INFORMATION THAT IS PROPRIETARY TO MOLEX INCORPORATED AND SHOULD NOT BE USED WITHOUT WRITTEN PERMISSION		