

FEATURES

- HSPA Compliant
- InGaP HBT Technology
- High Efficiency: (R99 waveform)
 40 % @ P_{OUT} = +28.5 dBm
 22 % @ P_{OUT} = +17 dBm
- Simpler Calibration with only 2 Bias Modes
- Low Quiescent Current: 9 mA
- Low Leakage Current in Shutdown Mode: <1 μA
- Internal Voltage Regulator
- Integrated “daisy chainable” directional couplers with CPL_{IN} and CPL_{OUT} Ports
- Optimized for a 50 Ω System
- Low Profile Miniature Surface Mount Package
- RoHS Compliant Package, 260 °C MSL-3

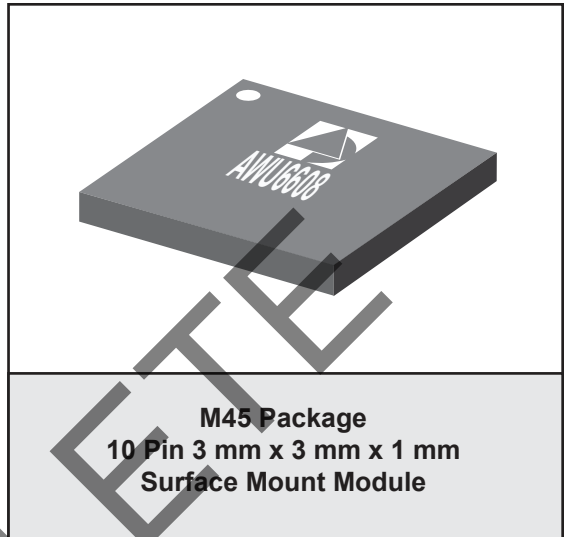

APPLICATIONS

- WCDMA/HSPA 900 MHz Band Wireless Handsets and Data Devices

PRODUCT DESCRIPTION

The AWU6608 HELP3™ PA is a 3rd generation WCDMA product for UMTS handsets. This PA incorporates ANADIGICS' HELP3™ technology to provide low power consumption without the need for an external voltage regulator. A “daisy chainable” directional coupler is integrated in the module thus eliminating the need of external couplers. The device is manufactured

on an advanced InGaP HBT MMIC technology offering state-of-the-art reliability, temperature stability, and ruggedness. There are two selectable bias modes that optimize efficiency for different output power levels, and a shutdown mode with low leakage current, which increases handset talk and standby time. The self-contained 3 mm x 3 mm x 1 mm surface mount package incorporates matching networks optimized for output power, efficiency, and linearity in a 50 Ω system.

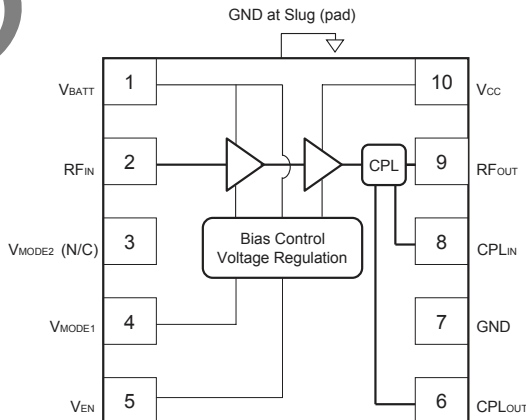

Figure 1: Block Diagram

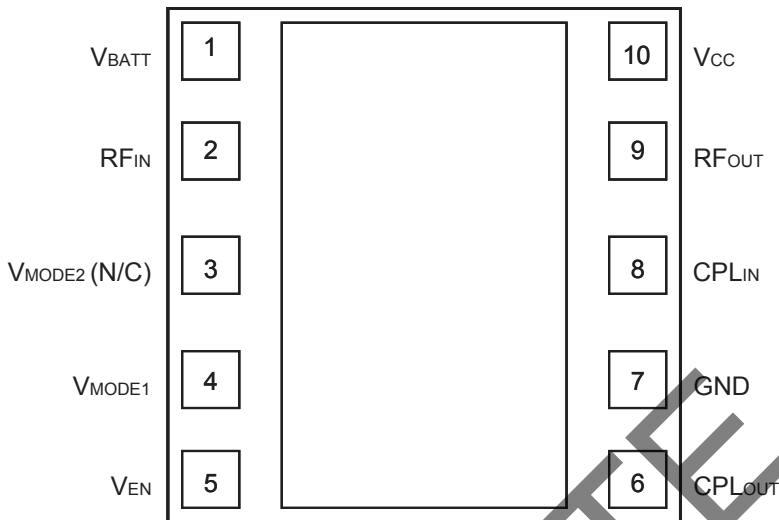

Figure 2: Pinout (X-ray Top View)

Table 1: Pin Description

PIN	NAME	DESCRIPTION
1	V _{BATT}	Battery Voltage
2	RF _{IN}	RF Input
3	V _{MODE2} (N/C)	No Connection
4	V _{MODE1}	Mode Control Voltage 1
5	V _{EN}	PA Enable Voltage
6	CPL _{OUT}	Coupler Output
7	GND	Ground
8	CPL _{IN}	Coupler Input
9	RF _{OUT}	RF Output
10	V _{CC}	Supply Voltage

ELECTRICAL CHARACTERISTICS

Table 2: Absolute Minimum and Maximum Ratings

PARAMETER	MIN	MAX	UNIT
Supply Voltage (V_{CC})	0	+5	V
Battery Voltage (V_{BATT})	0	+6	V
Control Voltages (V_{MODE1} , V_{ENABLE})	0	+3.5	V
RF Input Power (P_{IN})	-	+10	dBm
Storage Temperature (T_{STG})	-40	+150	°C

Stresses in excess of the absolute ratings may cause permanent damage. Functional operation is not implied under these conditions. Exposure to absolute ratings for extended periods of time may adversely affect reliability.

Table 3: Operating Ranges

PARAMETER	MIN	TYP	MAX	UNIT	COMMENTS
Operating Frequency (f)	880	-	915	MHz	
Supply Voltage (V_{CC})	+3.2	+3.4	+4.2	V	$P_{OUT} \leq +28.5$ dBm
Enable Voltage (V_{ENABLE})	+2.15 0	+2.4 0	+3.1 +0.5	V	PA "on" PA "shut down"
Mode Control Voltage (V_{MODE1})	+1.6 0	+2.4 -	+3.1 +0.5	V	Low Bias Mode High Bias Mode
RF Output Power (P_{OUT}) R99 WCDMA, HPM HSPA (MPR=0), HPM R99 WCDMA, LPM HSPA (MPR=0), LPM	28.0 ⁽¹⁾ 27.0 ⁽¹⁾ 16.5 ⁽¹⁾ 15.5 ⁽¹⁾	28.5 27.5 17 16	28.5 27.5 17 16	dBm	3GPP TS 34.121-1, Rel 8, Subtest 1, Table C.11.1.3
Case Temperature (T_c)	-30	-	+90	°C	

The device may be operated safely over these conditions; however, parametric performance is guaranteed only over the conditions defined in the electrical specifications.

Notes:

(1) For operation at $V_{CC} = +3.2$ V, P_{OUT} is derated by 0.5 dB.

Table 4: Electrical Specifications

(T_C = +25 °C, V_{CC} = +3.4 V, V_{BATT} = +3.4 V, V_{ENABLE} = +2.4 V, 50 Ω system, R99 waveform)

PARAMETER	MIN	TYP	MAX	UNIT	COMMENTS	
					P _{OUT}	V _{MODE1}
Gain	25 13	27.5 15.5	31 18	dB	+28.5 dBm +17 dBm	0 V 2.4 V
ACLR1 at 5 MHz offset ⁽¹⁾	- -	-41 -42	-38 -38	dBc	+28.5 dBm +17 dBm	0 V 2.4 V
ACLR2 at 10 MHz offset	- -	-57 -56	-48 -48	dBc	+28.5 dBm +17 dBm	0 V 2.4 V
Power-Added Efficiency ⁽¹⁾	36 19	40 22	- -	%	+28.5 dBm +17 dBm	0 V 2.4 V
Quiescent Current (I _{cq}) Low Bias Mode	-	9	13	mA	V _{MODE1} = +2.4 V	
Mode Control Current	-	0.1	0.25	mA	through V _{MODE} pin, V _{MODE1} = +2.4 V	
Enable Current	-	0.4	0.6	mA	through V _{ENABLE} pin	
BATT Current	-	3.0	5	mA	through V _{BATT} pin, V _{MODE1} = +2.4 V	
Leakage Current	-	<1	-	μA	V _{BATT} = +4.2 V, V _{CC} = +4.2 V, V _{ENABLE} = 0 V, V _{MODE1} = 0 V	
Noise in Receive Band ⁽²⁾	-	-135	-133	dBm/Hz	P _{OUT} ≤ +28.5 dBm, V _{MODE1} = 0V	
	-	-143	-138	dBm/Hz	P _{OUT} ≤ 17 dBm, V _{MODE1} = +2.4 V	
Harmonics 2fo 3fo, 4fo	- -	-35 -45	-30 -35	dBc	P _{OUT} ≤ +28.5 dBm	
Input Impedance	-	-	-	VSWR		
Coupling Factor	-	19	-	dB		
Directivity	-	20	-	dB		
Coupler IN-OUT Daisy Chain Insertion Loss	-	0.25	-	dB	698 MHz to 2620 MHz Pin 8 to 6, Shutdown Mode	
Spurious Output Level (all spurious outputs)	-	-	-70	dBc	P _{OUT} ≤ +28.5 dBm In-band load VSWR < 5:1 Out-of-band load VSWR < 10:1 Applies over all operating conditions	
Load mismatch stress with no permanent degradation or failure	8:1	-	-	VSWR	Applies over full operating range	
Phase Delta	-	25	-	Deg		

Notes:

(1) ACLR and Efficiency measured at 897.5 MHz.

(2) Noise measured at 925 MHz to 960 MHz.

APPLICATION INFORMATION

To ensure proper performance, refer to all related Application Notes on the ANADIGICS web site: <http://www.anadigics.com>

Shutdown Mode

The power amplifier may be placed in a shutdown mode by applying logic low levels (see Operating Ranges table) to the V_{ENABLE} and V_{MODE1} voltages.

Bias Modes

The power amplifier may be placed in either a Low Bias mode or a High Bias mode by applying the appropriate

logic level (see Operating Ranges table) to V_{MODE1} . The Bias Control table lists the recommended modes of operation for various applications. V_{MODE2} is not necessary for this PA.

Two operating modes are available to optimize current consumption. High Bias/High Power operating mode is for P_{OUT} levels ≥ 16 dBm. At around 17 dBm output power, the PA can be "Mode Switched" to Medium/Low power mode for lowest quiescent current consumption.

Table 5: Bias Control (UMTS)

APPLICATION	P_{OUT} LEVELS	BIAS MODE	V_{ENABLE}	V_{MODE1}	V_{CC}	V_{BATT}
UMTS - med/low power (Low Bias Mode)	$\leq +17$ dBm	Low	+2.4 V	+2.4 V	3.2 - 4.2 V	≥ 3.2 V
UMTS - high power (High Bias Mode)	$> +16$ dBm	High	+2.4 V	0 V	3.2 - 4.2 V	≥ 3.2 V
Optional lower V_{CC} in low power mode	$\leq +7$ dBm	Low	+2.4 V	+2.4 V	1.5 V	≥ 3.2 V
Shutdown	-	Shutdown	0 V	0 V	3.2 - 4.2 V	≥ 3.2 V

CHARACTERIZATION DATA
(WCDMA Rel 99, $V_{CC} = 3.4\text{ V}$, $V_{EN} = 2.4\text{ V}$, $T = 25\text{ }^{\circ}\text{C}$)

Figure 3: Gain vs Output Power

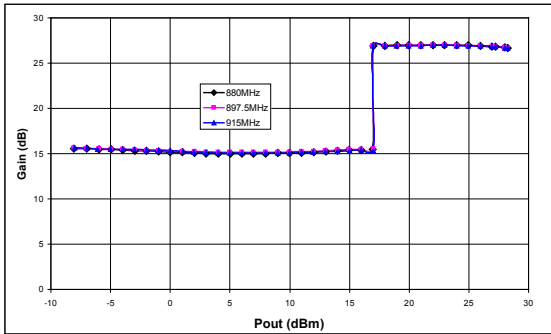

Figure 4: Current vs Output Power

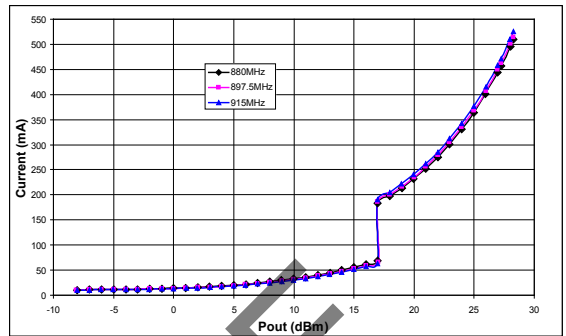

Figure 5: ACLR1 (5 MHz offset) vs Output Power

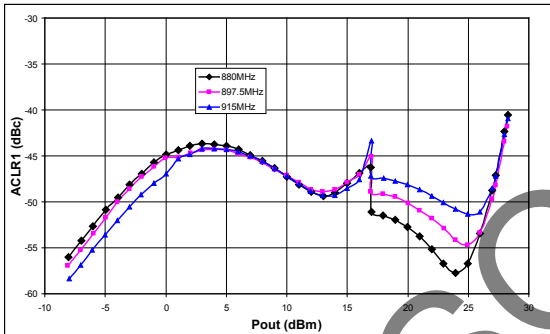

Figure 6: ACLR2 (10 MHz offset) vs Output

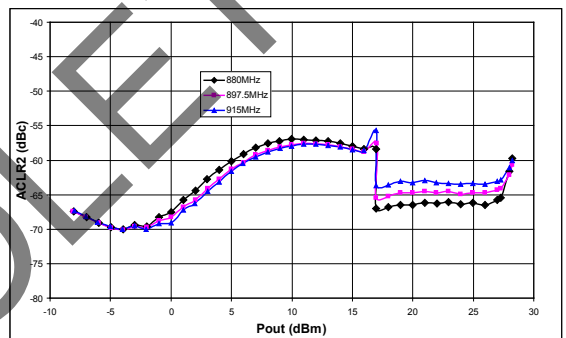
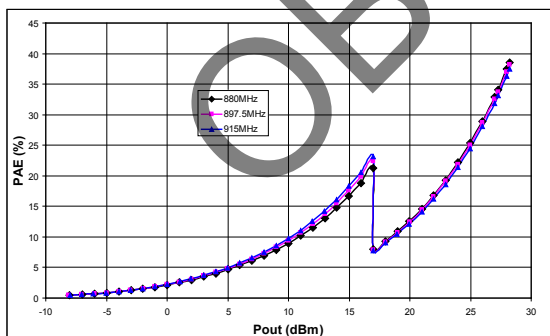

Figure 7: Efficiency vs Output Power



CHARACTERIZATION DATA
 (HSPA, Rel 8, $V_{CC} = 3.4\text{ V}$, $V_{EN} = 2.4\text{ V}$, $T = 25\text{ }^{\circ}\text{C}$)

Figure 8: Gain vs Output Power

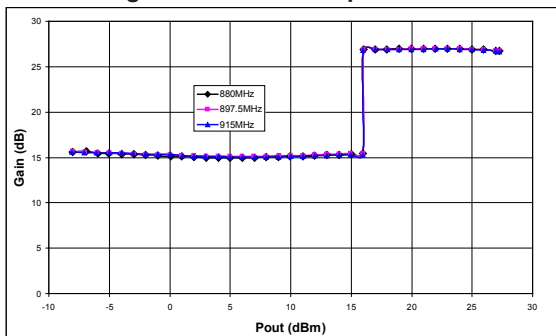

Figure 9: Current vs Output Power

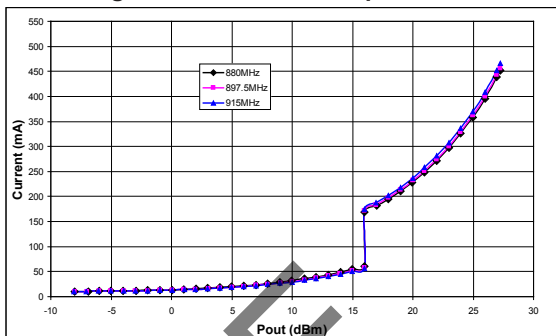

Figure 10: ACLR1 (5 MHz offset) vs Output

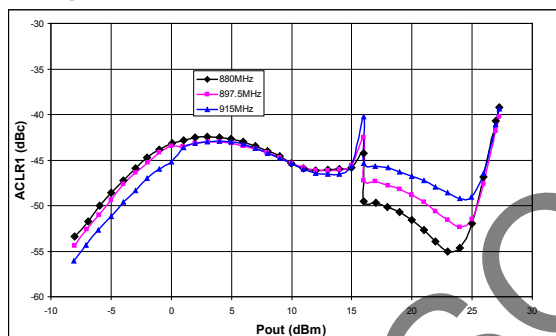

Figure 11: ACLR2 (10 MHz offset) vs Output

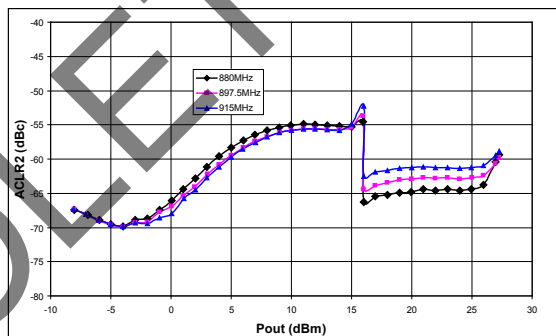
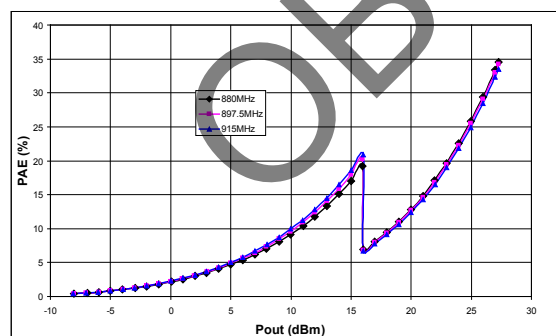

Figure 12: Efficiency vs Output Power



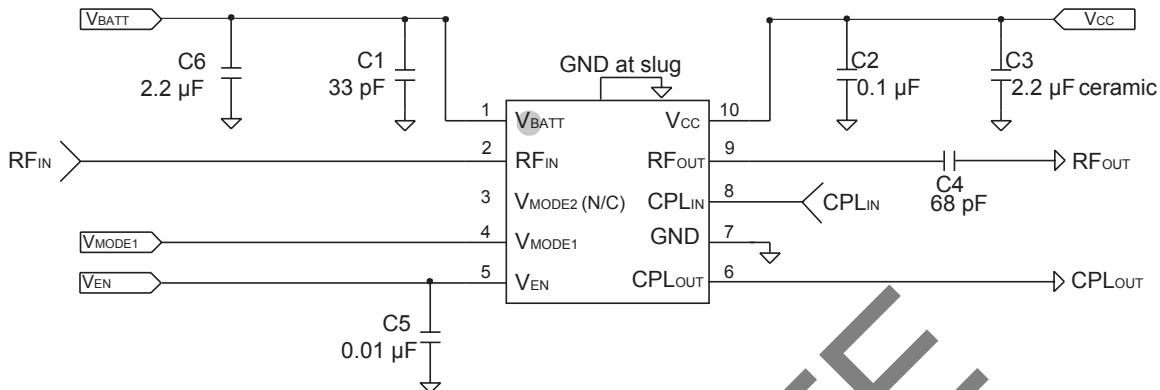

Figure 13: Evaluation Circuit Schematic

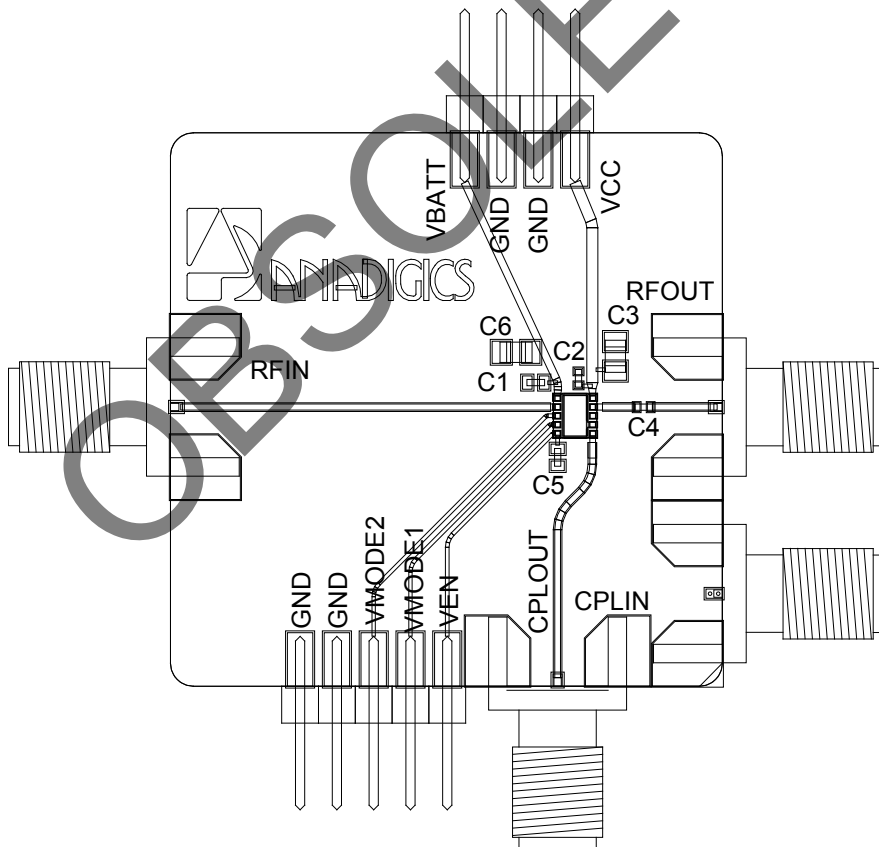

Figure 14: Evaluation Board Layout

HELP3

The AWU6608 power amplifier module is based on ANADIGICS proprietary HELP3™ technology. The PA is designed to operate up to 17 dBm in the low power mode, thus eliminating the need for three gain state, while still maintaining low quiescent current and high efficiency in low and medium power levels. The PA can still be operated as 3 gain state device if the customer chooses to. The directional “daisy chainable” coupler is integrated within the PA module, therefore there is no need for external couplers.

The AWU6608 has an integrated voltage regulator, which eliminates the need for an external constant voltage source. The PA is turn on/off is controlled by V_{EN} pin. A single V_{MODE} control logic (V_{MODE1}) is needed to operate this device.

The DG09 power distribution (figure 15) highlights the need to improve the current consumption in low and medium power level. The AWU6608 is designed to operate up to 17 dBm in the low power mode with very low quiescent current. Current consumption for AWU6608 is also plotted in the figure 5.

AWU6608 requires only two calibration sweeps for system calibration, thus saving calibration time.

Figure 16 shows one application example on mobile board. C1 and C2 are RF bypass caps and should be placed nearby pin 1 and pin 10. Bypass caps C9 and C5 may not be needed. Also a “T” matching topology is recommended at PA RF_{IN} and RF_{OUT} ports to provide matching between input TX Filter and Duplexer / Isolator.

Figure 15: PDF and Current

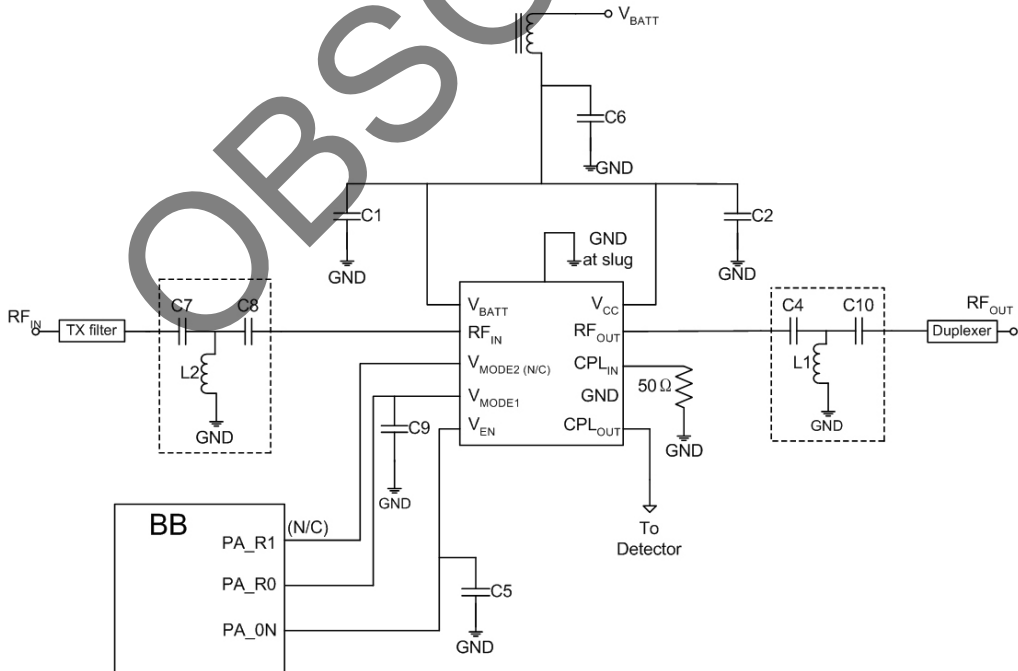
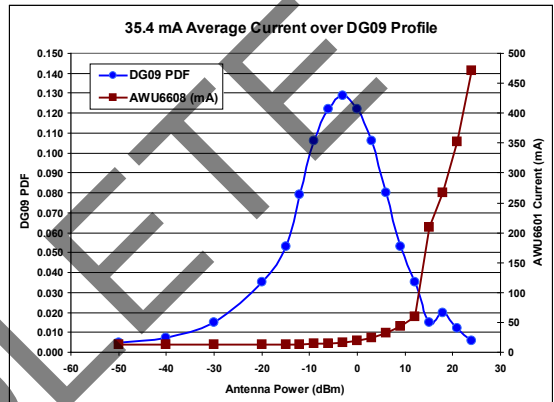
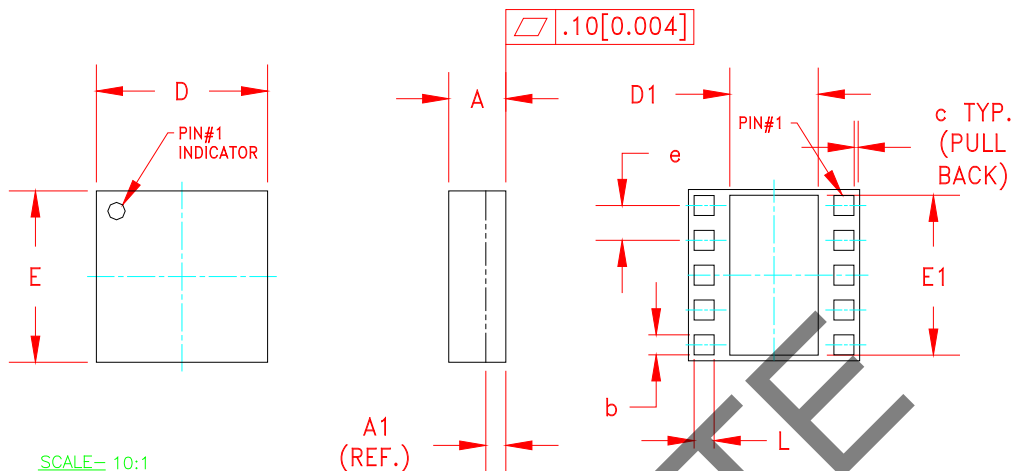

Figure 16: Typical Application Circuit

PACKAGE OUTLINE



Symbol	MILLIMETERS			INCHES			NOTE
	MIN.	NOM.	MAX.	MIN.	NOM.	MAX.	
A	0.91	1.03	1.13	0.035	0.041	0.044	—
A1	PLEASE REFER TO LAMINATE CONTROL DRAWING						—
b	0.32	0.35	0.40	0.013	0.014	0.016	3
c	—	0.10	—	—	0.004	—	—
D	2.88	3.00	3.12	0.113	0.118	0.123	—
D1	1.45	1.50	1.57	0.057	0.059	0.062	3
E	2.88	3.00	3.12	0.113	0.118	0.123	—
E1	2.70	2.75	2.85	0.106	0.108	0.112	3
e	0.60				0.024		3
L	0.32	0.35	0.40	0.013	0.014	0.016	3

NOTES:

1. CONTROLLING DIMENSIONS: MILLIMETERS
2. UNLESS SPECIFIED TOLERANCE= $\pm 0.076[0.003]$.
3. PADS (INCLUDING CENTER) SHOWN UNIFORM SIZE FOR REFERENCE ONLY. ACTUAL PAD SIZE AND LOCATION WILL VARY WITHIN MIN. AND MAX. DIMENSIONS ACCORDING TO SPECIFIC LAMINATE DESIGN.
4. UNLESS SPECIFIED DIMENSIONS ARE SYMMETRICAL ABOUT CENTER LINES SHOWN.
5. LAMINATE CONTROL DRAWING SPECIFIED BY PART NUMBER.

Figure 17: M45 Package Outline - 10 Pin 3 mm x 3 mm x 1 mm Surface Mount Module

TOP BRAND

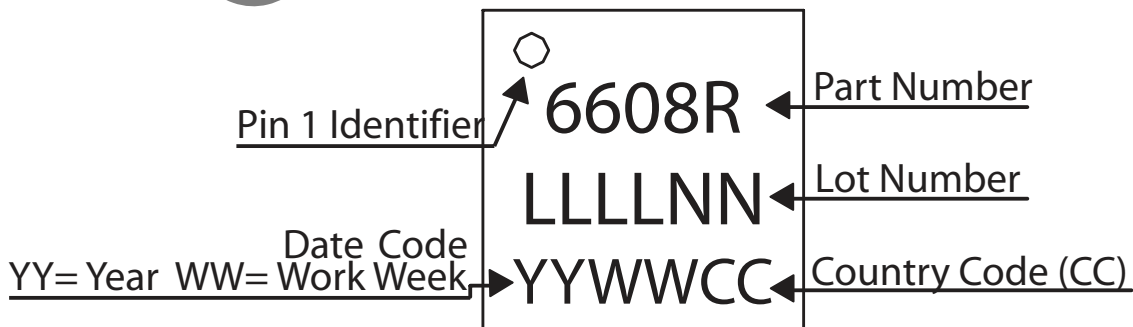
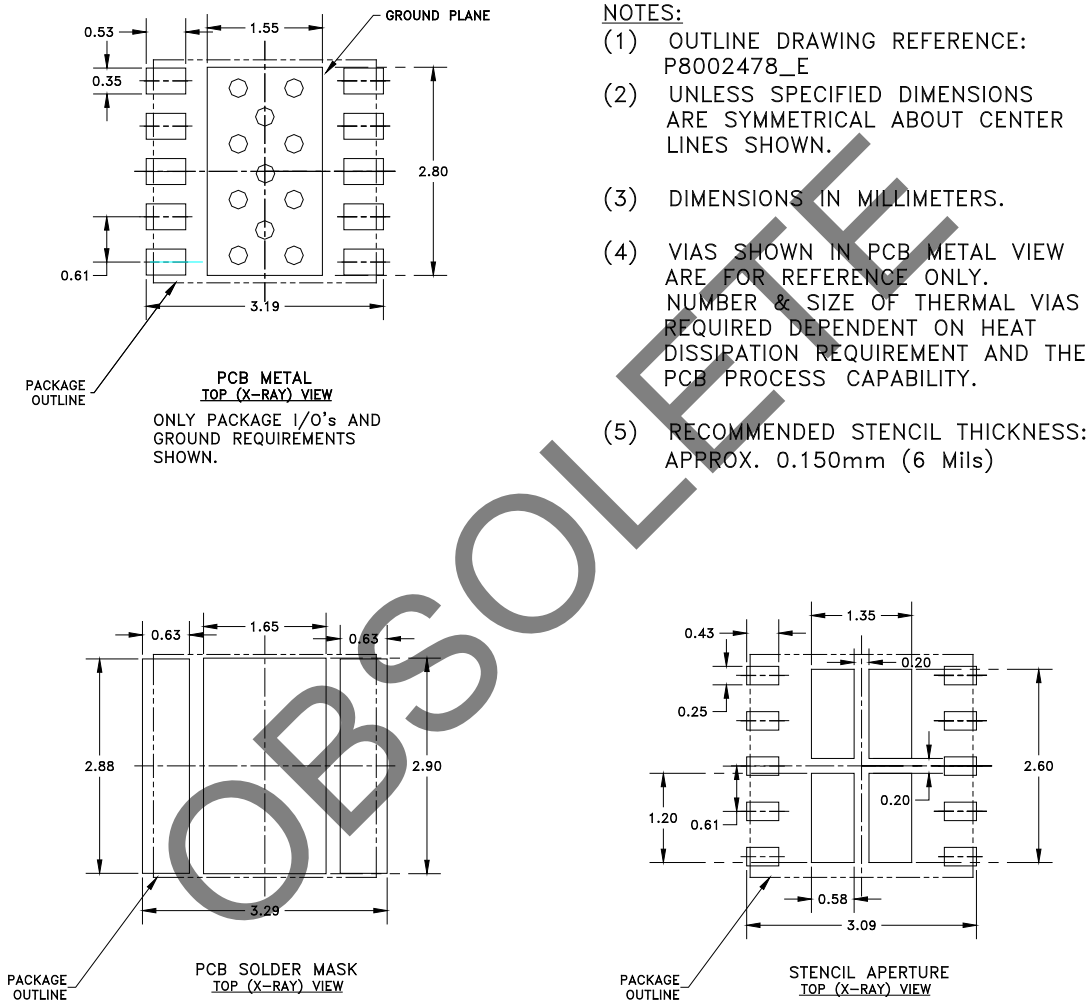
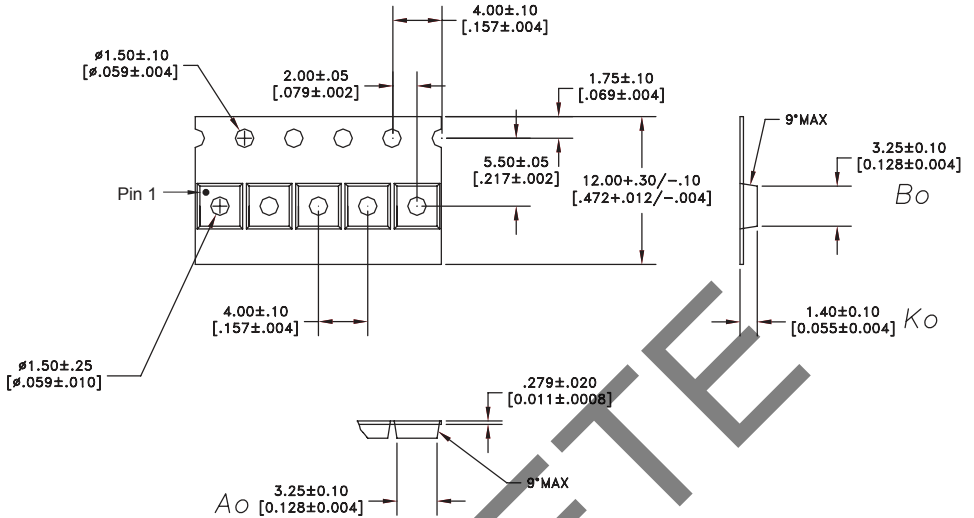

Figure 18: Branding Specification - M45 Package

PCB AND STENCIL DESIGN GUIDELINE



COMPONENT PACKAGING



NOTES:

- 1. MATERIAL: 3000 (CARBON FILLED POLYCARBONATE)
100% RECYCLABLE.

DIMENSIONS ARE IN MILLIMETERS [INCHES]

DIMENSIONING AND TOLERANCING PER ASME Y14.5M-1994

Figure 6: Tape & Reel Packaging

Table 6: Tape & Reel Dimensions

PACKAGE TYPE	TAPE WIDTH	POCKET PITCH	REEL CAPACITY	MAX REEL DIA
3 mm x 3 mm x 1 mm	12 mm	4 mm	2500	7"

ORDERING INFORMATION

ORDER NUMBER	TEMPERATURE RANGE	PACKAGE DESCRIPTION	COMPONENT PACKAGING
AWU6608RM45Q7	-30 °C to +90 °C	RoHS Compliant 10 Pin 3 mm x 3 mm x 1 mm Surface Mount Module	Tape and Reel, 2500 pieces per Reel
AWU6608RM45P9	-30 °C to +90 °C	RoHS Compliant 10 Pin 3 mm x 3 mm x 1 mm Surface Mount Module	Partial Tape and Reel

OBSOLETE



ANADIGICS, Inc.
 141 Mount Bethel Road
 Warren, New Jersey 07059, U.S.A.
 Tel: +1 (908) 668-5000
 Fax: +1 (908) 668-5132

URL: <http://www.anadigics.com>

IMPORTANT NOTICE

ANADIGICS, Inc. reserves the right to make changes to its products or to discontinue any product at any time without notice. The product specifications contained in Advanced Product Information sheets and Preliminary Data Sheets are subject to change prior to a product's formal introduction. Information in Data Sheets have been carefully checked and are assumed to be reliable; however, ANADIGICS assumes no responsibilities for inaccuracies. ANADIGICS strongly urges customers to verify that the information they are using is current before placing orders.

WARNING

ANADIGICS products are not intended for use in life support appliances, devices or systems. Use of an ANADIGICS product in any such application without written consent is prohibited.