

# LEDMCUEVM-132 MSP432™ LED Controller Evaluation Module



## ABSTRACT

This user's guide describes the specifications, board connection description, characteristics, operation, and use of the LEDMCUEVM-132 that uses the MSP432™ to control specific LED evaluation modules (EVMS). A complete schematic diagram, printed circuit board layouts, and bill of materials are included in this document.

## Table of Contents

<b>1 Description</b> .....	3
1.1 Typical Applications.....	3
1.2 Connector Description .....	4
<b>2 Features and Specifications</b> .....	6
<b>3 Schematic, PCB Layout, and Bill of Materials</b> .....	6
3.1 Schematic.....	7
3.2 Layout.....	8
3.3 Bill of Materials.....	11
<b>4 Software</b> .....	14
4.1 Demonstration Kit Software Installation for LEDMCUEVM-132 Board.....	14
4.2 Step-by-Step Installation Instructions.....	14
4.3 Installation Error Recovery.....	23
4.4 Checking for Updates.....	24
<b>5 LEDMCUEVM-132 Power UP and Operation</b> .....	28
5.1 GUI Start-up.....	28
5.2 MCU Control Window.....	31
5.3 SPI Command Window.....	33
5.4 GUI Devices Window and Example Connections and Power Up.....	36

## List of Figures

Figure 1-1. Connection Diagram of Computer, USB Cable, and LEDMCUEVM-132.....	4
Figure 2-1. High-Level Diagram of the LEDMCUEVM-132.....	6
Figure 3-1. LEDMCUEVM-132 Schematic.....	7
Figure 3-2. TPS92520EVM-133 Assembly Drawing.....	8
Figure 3-3. TPS92520EVM-133 Top Layer and Top Overlay (Top View).....	8
Figure 3-4. TPS92520EVM-133 Inner-Layer 1.....	9
Figure 3-5. TPS92520EVM-133 Inner-Layer 2.....	9
Figure 3-6. TPS92520EVM-133 Bottom Layer and Bottom Overlay (Bottom View).....	10
Figure 4-1. Setup Screen 1.....	14
Figure 4-2. Setup Screen 2.....	15
Figure 4-3. Setup Screen 3.....	15
Figure 4-4. Setup Screen 4.....	16
Figure 4-5. Setup Screen 5.....	16
Figure 4-6. Setup Screen 6.....	17
Figure 4-7. Setup Screen 7.....	17
Figure 4-8. Setup Screen 8.....	18
Figure 4-9. Setup Screen 9.....	18
Figure 4-10. Setup Screen 10.....	19
Figure 4-11. Setup Screen 11.....	19
Figure 4-12. Setup Screen 12.....	20
Figure 4-13. Setup Screen 13.....	20
Figure 4-14. Setup Screen 14.....	21

Figure 4-15. Setup Screen 15.....	21
Figure 4-16. Setup Screen 16.....	21
Figure 4-17. Setup Screen 17.....	22
Figure 4-18. Setup Screen 18.....	22
Figure 4-19. Setup Screen 19.....	23
Figure 4-20. Help Menu and Checking for Updates.....	24
Figure 4-21. Update Screen 1.....	24
Figure 4-22. Update Screen 2.....	25
Figure 4-23. J15 Jumper and RESET_SW1 Switch for Bootloader Mode.....	25
Figure 4-24. Setup Screen 5.....	26
Figure 4-25. Setup Screen 6.....	26
Figure 4-26. J15 Jumper and RESET_SW1 Switch for Normal Mode.....	27
Figure 5-1. LEDMCUEVM-132 Connection to PC Using USB Cable.....	28
Figure 5-2. GUI Setup Screen 1.....	29
Figure 5-3. GUI EVM Selection and Setup Screen.....	29
Figure 5-4. TPS92520 - EVM133 GUI Start-up Screen Showing Different Windows.....	30
Figure 5-5. MCU Control (External PWM) Window.....	31
Figure 5-6. MCU Exnternal PWM for PWM_1 and PWM_2.....	31
Figure 5-7. MCU Exnternal PWM for PWM_3 and PWM_4.....	32
Figure 5-8. SPI Command Window.....	33
Figure 5-9. SPI Read Example.....	34
Figure 5-10. SPI Write Example.....	35
Figure 5-11. LEDMCUEVM-133 + TPS92520EVM-133 Connections and Setup.....	36
Figure 5-12. TPS92520EVM-133 Menu From EVM Selection and Setup Window.....	37
Figure 5-13. TPS92520EVM-133 Device Command Window.....	37
Figure 5-14. LEDMCUEVM-133 + TPS92518EVM-878 Connections and Setup.....	38
Figure 5-15. TPS92518EVM-878 Menu From EVM Selection and Setup Window.....	39
Figure 5-16. TPS92518EVM-878 Device Command Window.....	39
Figure 5-17. LEDMCUEVM-132 + TPS92682EVM-069 + TPS92520EVM-133 Connections and Setup.....	40
Figure 5-18. TPS92520, TPS92682 - LPP074 - E1 Menu From EVM Selection and Setup Window.....	40
Figure 5-19. Devices Window for the "TPS92520, TPS92682 - LPP074 - E1" Selection From "EVM Selection and Setup" Screen.....	41
Figure 5-20. LEDMCUEVM-132 + TPS92682EVM-069 + TPS92520EVM-133 + TPS92662EVM6-901 Connections and Setup.....	42
Figure 5-21. "TPS92520, TPS92682, TPS92662 - LPP074 - E2" Menu From EVM Selection and Setup Window.....	43
Figure 5-22. Devices Window for the TPS92520, TPS92682, TPS92662 - LPP074 - E2 Selection From EVM Selection and Setup Screen.....	43

## List of Tables

Table 1-1. Connector Descriptions.....	5
Table 1-2. Test Points.....	5
Table 3-1. LEDMCUEVM-132 Bill of Materials.....	11

## Trademarks

MSP432™, LauchPad™, and LaunchPad™ are trademarks of Texas Instruments.

Microsoft®, .NET Framework®, and Windows® are registered trademarks of Microsoft Corporation.

All trademarks are the property of their respective owners.

## 1 Description

This user's guide describes the specifications, board connection description, characteristics, operation, and use of the LEDMCUEVM-132 MCU LED controller evaluation module (EVM). The LEDMCUEVM-132 implements SPI communications that support multiple devices on the bus, UART communications for the LMMs family of devices, CAN transceiver for UART to control LMM family of devices, 4 PWM signals for dimming, multiple IOs, isolated 5-V supply, digital isolators, and a standard CAN bus with a transceiver. A complete schematic diagram, printed-circuit board layouts, and bill of materials are included in this document.

### 1.1 Typical Applications

This document outlines the operation and implementation of the LEDMCUEVM-132 as LED MCU controller board that communicates and controls other EVMs in the automotive LED driver and matrix managers.

## 1.2 Connector Description

Table 1-1 describes the connectors and Table 1-2 lists the test points on the EVM and how to properly connect, set up, and use the LEDMCUEVM-132.

Figure 1-1 shows the connection diagram and the default jumper locations of the LEDMCUEVM-132.

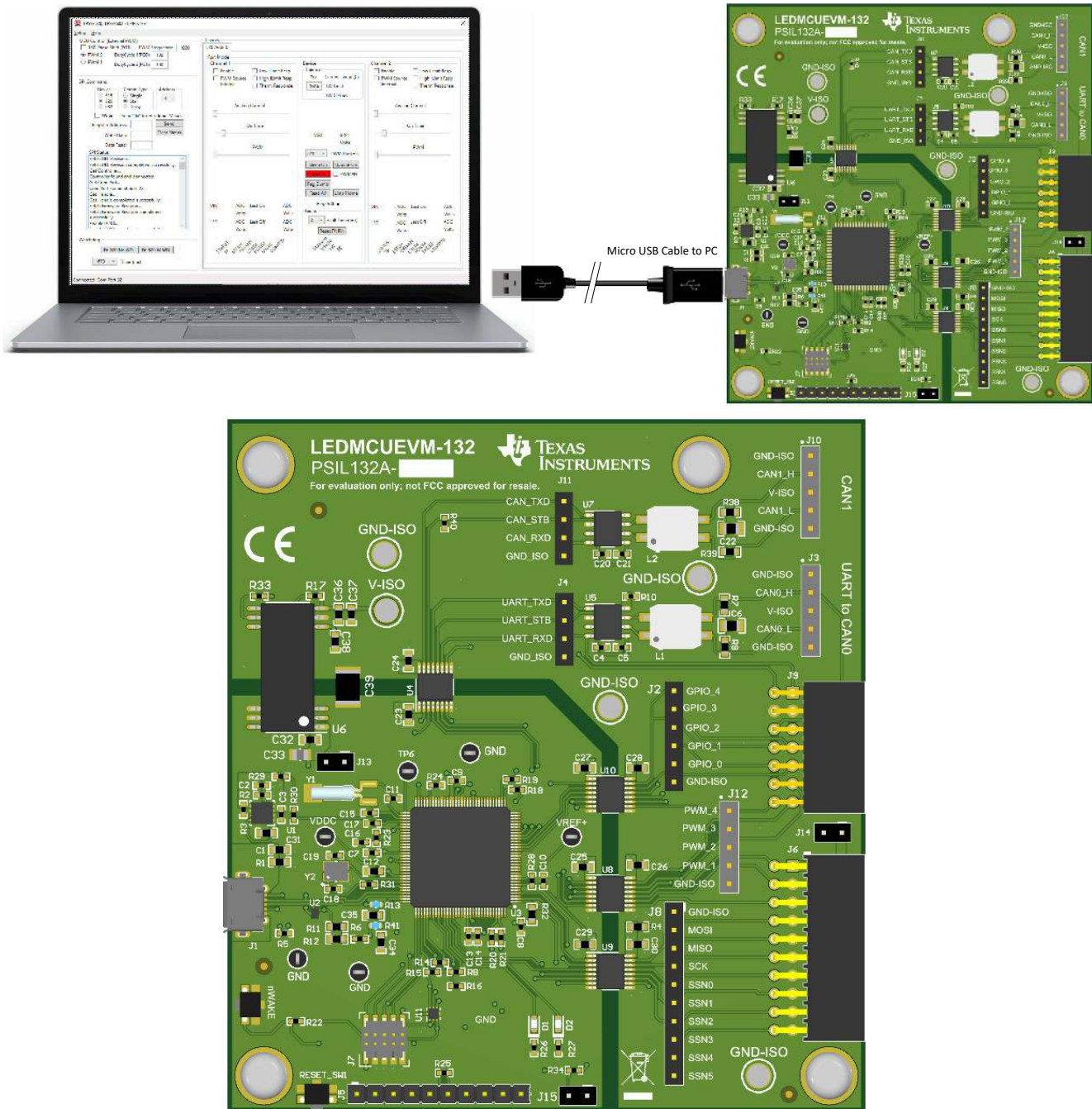


Figure 1-1. Connection Diagram of Computer, USB Cable, and LEDMCUEVM-132

**Table 1-1. Connector Descriptions**

Connector	Function	Description
J6	Provide primary SPI, SSN, and PWM signals to compatible EVMs	J6 includes the MISO, MOSI, SCK, SSN0-3, PWM1, PWM2, GPIO-0, and ground pins.
J9	Provide additional control signals to EVMs	J9 includes SNN4-5, PWM3-4, CANH-L, UART_RX-TX, GPIO1-4, PWM3-4, and GND-ISO, which is the ground of the EVM attached.
J1	Micro-USB connector to PC	Connector that uses Micro-USB cable to connect to the PC for GUI control.
J3	CAN0 bus signals that are generated from UART signals	J3 has CAN0_H, CAN0_L, V-ISO (5V), and GND-ISO, which is the ground of the attached EVM. The UART RXD and TXD signals are sent to an CAN-Transceiver to general the differential signals for CAN0 bus. J3 is a standard 100 mil header that can be used as test points or can be used to connect to an EVM by a cable harness.
J4	UART signals	J4 are the single ended UART TXD and RXD signals that are from the MCU. J4 is a standard 100 mil header that can either be used as test points or can be used to connect to an EVM by a cable harness.
J8	All SPI signals	J8 has all the SPI signals put together in one location for probing signals. It includes MISO, MOSI, SCK, SNN0-5, and GND-ISO. J8 is a standard 100 mil header that can either be used as test points or can be used to connect to an EVM by a cable harness.
J12	All PWM signals	J12 has all four PWM signals (PWM1, PWM2, PWM3, and PWM4) created be the MCU and GND-ISO. J12 is a standard 100 mil header that can either be used as test points or can be used to connect to an EVM by a cable harness.
J2	All GPIO signals	J9 has all five GPIO signals (GPIO_0, GPIO_1, GPIO_2, GPIO_3, and GPIO_4) on the header. J2 is a standard 100 mil header that can either be used as test points or can be used to connect to an EVM by a cable harness.
J10	CAN1 differential bus signals	J10 connects to the differential CAN1 bus which was generated from CAN1 port of MCU that is connected to the CAN transceiver. J10 is a standard 100 mil header that can either be used as test points or can be used to connect to an EVM by a cable harness.
J11	CAN1 single ended bus signals	J11 connects directly to the CAN1 signal ended signals that come from the MCU and go to the CAN transceiver. J11 is a standard 100 mil header that can either be used as test points or can be used to connect to an EVM by a cable harness.
J5	Launch Pad emulator connector	This is allows for the use of the LaunchPad™ emulator connections from other LaunchPads.
J7	XDIS110 programming connector	This connector allows for the debugging or programming of the MSP432 device.
J13	3v3 external supply connection	This allows for the connection of an external 3V3 supply that is not generated from the USB 5-V connection.
J15	BOOT-LOADER mode jumper	This jumper is used to place the MSP432 in boot-loader mode when an update to the firmware is needed.

**Table 1-2. Test Points**

Test Point	Description
GND (TP9, TP10, TP12)	These test points are connected to the GND connection from the PC through the USB cable.
GND-ISO (TP20, TP21, TP22, and TP25)	The test points are connected to the isolated grounds that connect to the secondary side of the digital isolators the the isolate 5-V supply. GND-ISO connects to the GND connections of the EVMs.
V-ISO (TP24)	This test point connects to V-ISO, which is an isolated 5 V that power the digital isolators and can be used by EVMs as an external 5-V supply.
VREF+ (TP11)	This test point connects to reference voltage of the MSP432.
nHIG (TP6)	This test point connects to the inhibit pin of the MSP432.
VDDC (TP7)	This test point connects to the VDDC pin of the MSP432.

## 2 Features and Specifications

The LEDMCUEVM-132 provides a host of features that allow it to be used with a variety of EVMs and for the easy evaluation and debug of devices and systems.

- A SPI bus that supports up to six devices is provided and is accessed via J6, J9, and J12 connectors. It comes from the MCU (MSP432E401Y) through a digital isolator to the connectors. J12 can be used with debug probes or can be mated to a connector that uses a standard 100-mil header.
- There are two pairs of PWM signals (PWM1 + PWM2 and PWM3 + PWM4) that can be used for PWM dimming of supported devices. These signals support up to 4 kHz operation and have the ability to be phase shifted by 180 degrees. J12 is a standard 100-mil head that can either be used for probing or to mate with a standard 100-mil connector.
- Five GPIOs are provided and depending on the **EVM selection** the GPIOs are either enabled or disabled. See the user's guide of the EVM for more details.
- The MCU generates UART commands that are used by the TPS92662 lighting matrix manager device. The single-ended communication is passed through a digital isolator and into a CAN transceiver to generate a differential signal that is commonly used in noisy environments. Either the single-ended UART signals are available via J4 header or the differential CAN signals are available by header J3.
- There is an isolated 5-V supply that is created from the USB bus (5 V) and is supplied to the secondary side to power the digital isolators, CAN transceivers, and is passed on to other EVMs as V-ISO. Not all EVMs use this supply. Some have their own supplies separated from the LEDMCUEVM-133.
- The LEDMCUEVM-133 supports firmware updates by the USB connection to the PC.
- If the customer wants to develop their own firmware for the MSP432E401Y, then they have that ability to do that by using J7 and the XDIS110 JTAG Debug Probe.
- The MSP432E401Y can also be connected to the Emulator connections of an external MSP-EXP432E401Y LaunchPad using J5.
- The LEDMCUEVM-132 has a connection to the CAN bus of the MSP432 and it is also attached to a CAN transceiver to generate a CAN signal. This hardware is not yet supported by the GUI.

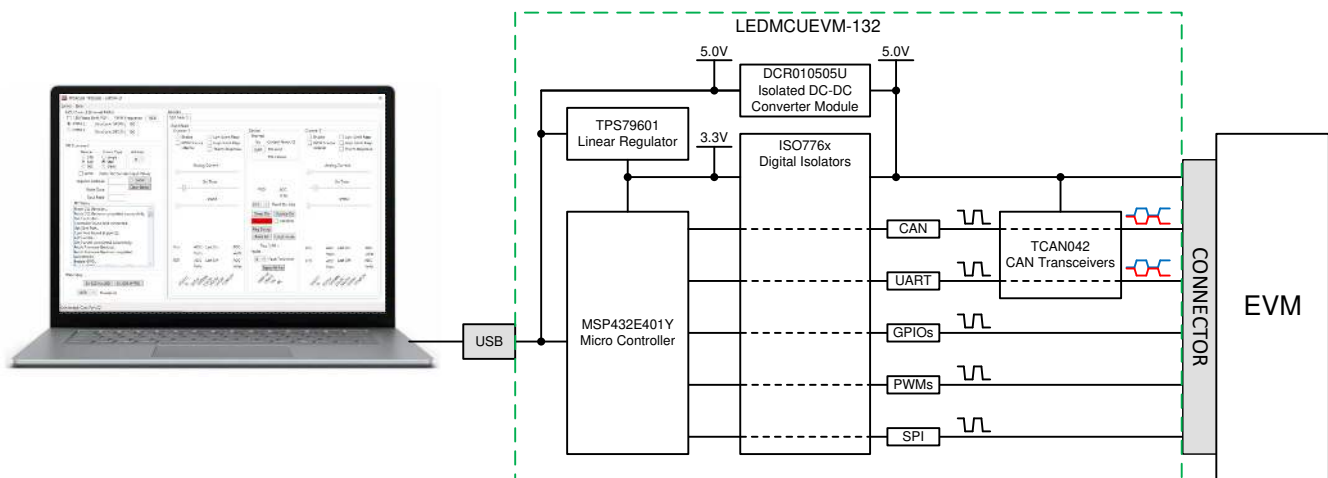


Figure 2-1. High-Level Diagram of the LEDMCUEVM-132

## 3 Schematic, PCB Layout, and Bill of Materials

This section contains the [LEDMCUEVM-132](#) schematics, PCB layouts, and bill of materials (BOM).

### 3.1 Schematic

Figure 3-1 illustrates the LEDMCUEVM-132 schematic.

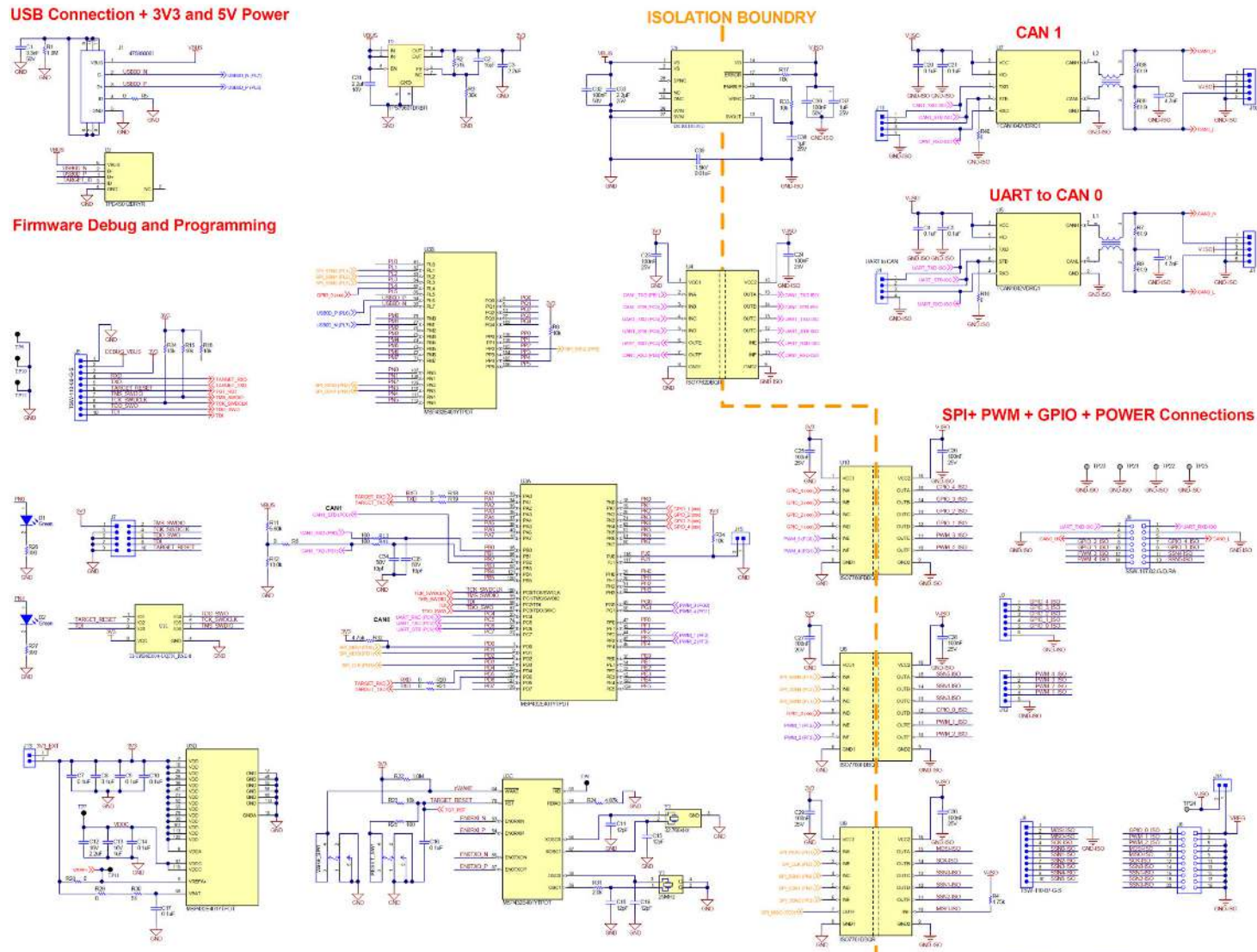


Figure 3-1. LEDMCUEVM-132 Schematic

### 3.2 Layout

The LEDMCUEVM-132 is a 4-layer board. Figure 3-2, Figure 3-3, Figure 3-4, Figure 3-5, and Figure 3-6 illustrate the assembly, top, inner-layer1, inner-layer2, and the bottom side of the LEDMCUEVM-132 PCB layout. The Inner-layer 1 is a ground plane and there is no routing on this layer.

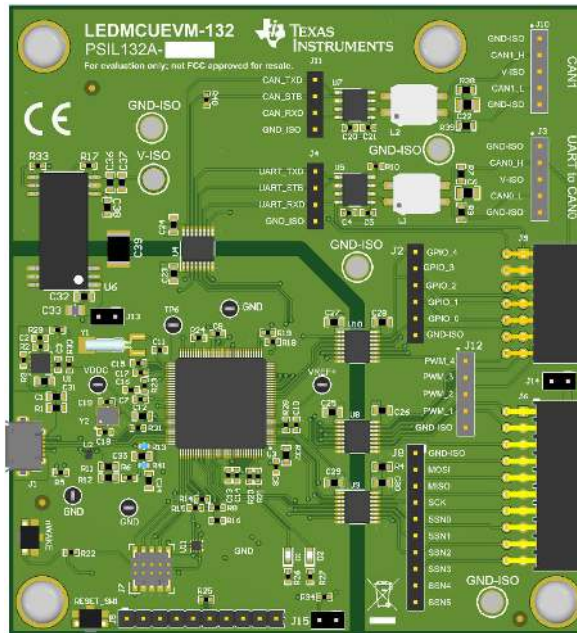


Figure 3-2. TPS92520EVM-133 Assembly Drawing

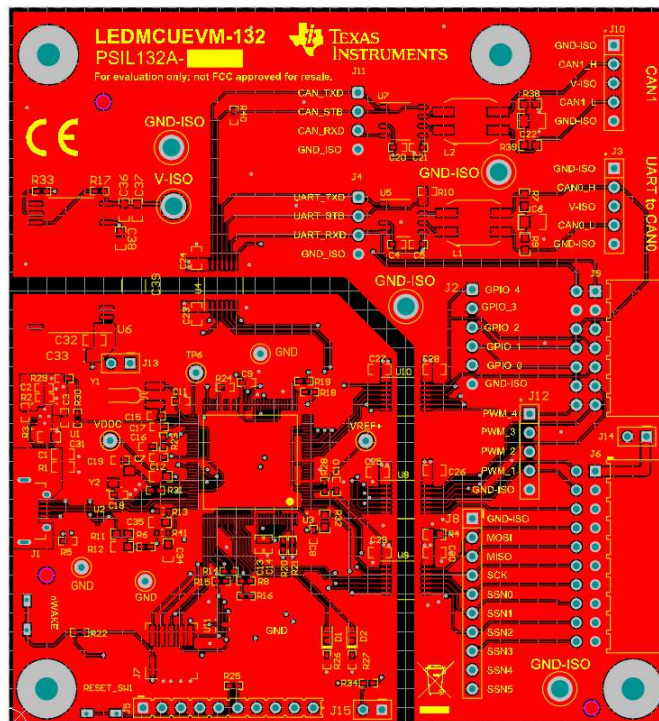
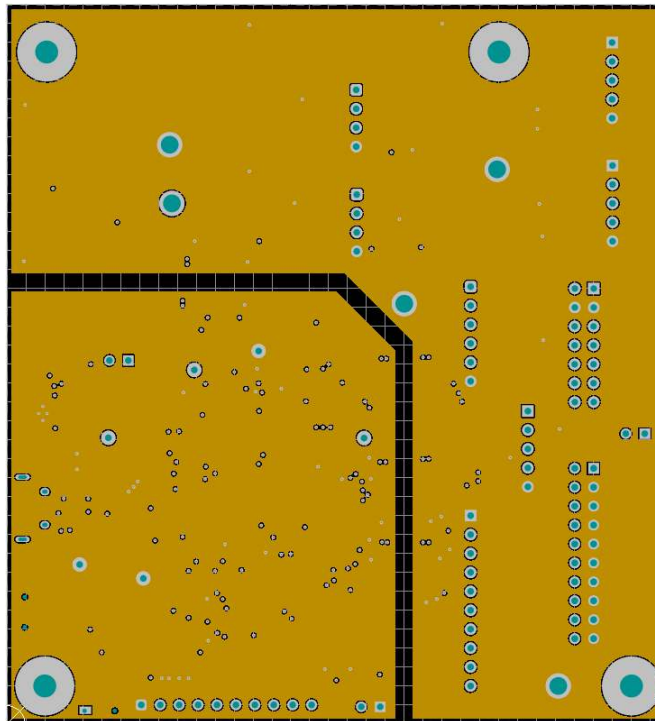
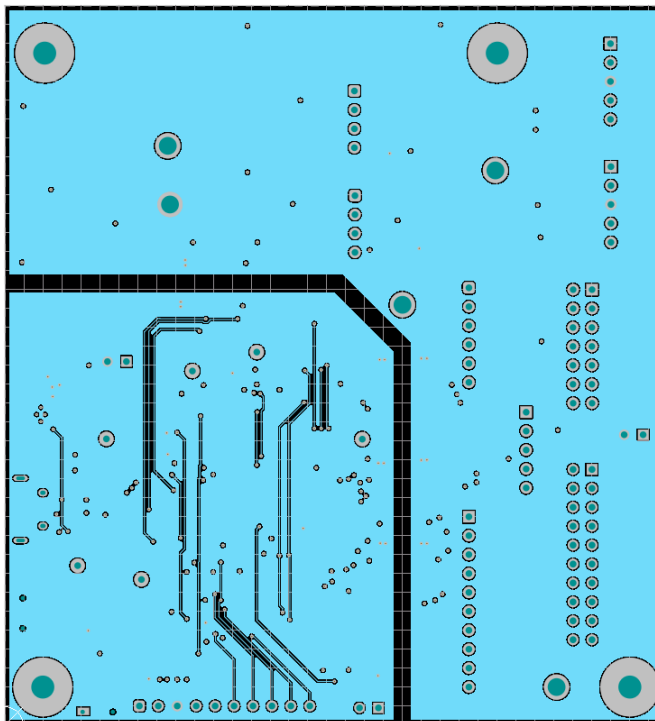


Figure 3-3. TPS92520EVM-133 Top Layer and Top Overlay (Top View)





**Figure 3-4. TPS92520EVM-133 Inner-Layer 1**



**Figure 3-5. TPS92520EVM-133 Inner-Layer 2**

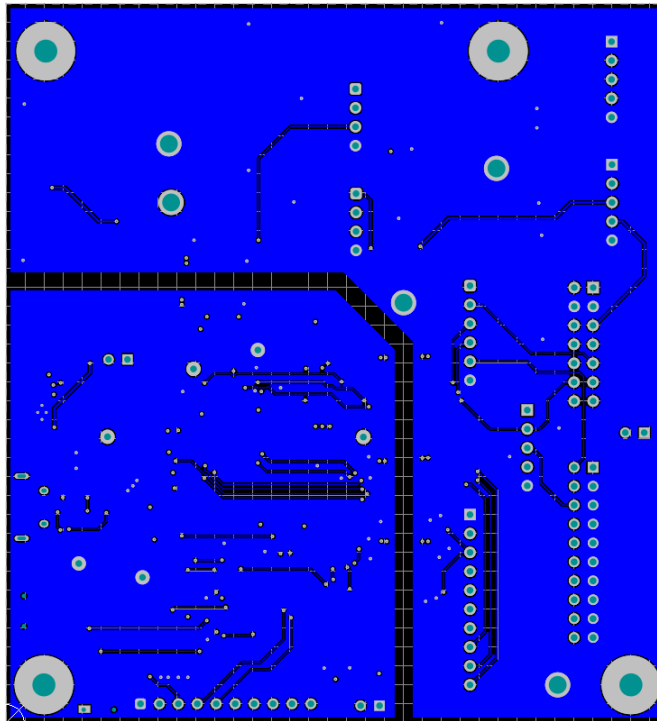


Figure 3-6. TPS92520EVM-133 Bottom Layer and Bottom Overlay (Bottom View)

### 3.3 Bill of Materials

Table 3-1 lists the LEDMCUEVM-132 bill of materials.

**Table 3-1. LEDMCUEVM-132 Bill of Materials**

Designator	Qty	Value	Description	Package	Part Number	Manufacturer
C1	1	3,300 pF	CAP, CERM, 3300 pF, 50 V, +/- 10%, X7R	0603	885012206086	Würth Elektronik
C2	1	15 pF	CAP, CERM, 15 pF, 50 V, +/- 5%, C0G/NP0	0402	GRM1555C1H150JA01D	MuRata
C3	1	2.2 µF	CAP, CERM, 2.2 µF, 6.3 V, +/- 10%, X5R	0402	GRM155R60J225KE95D	MuRata
C4, C5, C20, C21	4	0.1 µF	CAP, CERM, 0.1 µF, 50 V, +/- 20%, X7R, AEC-Q200 Grade 1	0402	CGA2B3X7R1H104M050BB	TDK
C6, C22	2	4,700 pF	CAP, CERM, 4700 pF, 50 V, +/- 10%, X7R	0805	C0805C472K5RACTU	Kemet
C7, C8, C9, C10, C14, C16, C17	7	0.1 µF	CAP, CERM, 0.1 µF, 16 V, +/- 10%, X7R	0402	GRM155R71C104KA88D	MuRata
C11, C15, C18, C19	4	12 pF	CAP, CERM, 12 pF, 50 V, +/- 5%, C0G/NP0	0402	GRM1555C1H120JA01D	MuRata
C12	1	2.2 µF	CAP, CERM, 2.2 µF, 16 V, +/- 20%, X5R	0603	885012106018	Würth Elektronik
C13	1	1 µF	CAP, CERM, 1 µF, 16 V, +/- 10%, X5R	0402	EMK105BJ105KVHF	Taiyo Yuden
C23, C24, C25, C26, C27, C28, C29, C30	8	0.1 µF	AP, CERM, 0.1 µF, 25 V, +/- 10%, X7R, AEC-Q200 Grade 1	0603	CGA3E2X7R1E104K080AA	TDK
C31	1	2.2 µF	CAP, CERM, 2.2 µF, 10 V, +/- 10%, X7R, AEC-Q200 Grade 1	0603	GRM188R71A225KE15J	MuRata
C32, C36	2	0.1 µF	CAP, CERM, 0.1 µF, 50 V, +/- 10%, X7R	0603	06035C104KAT2A	AVX
C33	1	2.2 µF	CAP, CERM, 2.2 µF, 25 V, +/- 10%, X7R	0805	08053C225KAT2A	AVX
C34, C35	2	10 pF	CAP, CERM, 10 pF, 50 V, +/- 5%, C0G/NP0, AEC-Q200 Grade 1	0603	CGA3E2C0G1H100D080AA	TDK
C37, C38	2	1 µF	CAP, CERM, 1 µF, 25 V, +/- 10%, X7R, AEC-Q200 Grade 1	0603	GCM188R71E105KA64D	MuRata
C39	1	0.01 µF	CAP, CERM, 0.01 µF, 1500 V, +/- 10%, X7R	1812	1812SC103KAT1A	AVX
D1, D2	2		LED, Green	1.6x0.8x0.8mm	LTST-C190GKT	Lite-On
H1	1		HEAT SINK FOR TI MOD, 50x13.9mm		ATS-TI10P-521-C1-R1	Advanced Thermal Solutions
H1, H2, H3, H4	4		Machine Screw, Round, #4-40 x 1/4, Nylon, Phillips panhead		NY PMS 440 0025 PH	B&F Fastener Supply
H5, H6, H7, H8	4		Standoff, Hex, 0.5"L #4-40 Nylon		1902C	Keystone
J1	1		Connector, Receptacle, Micro-USB Type AB, R/A, Bottom Mount SMT	5.6x2.5x8.2mm	475890001	Molex
J2	1		Header, 100mil, 6x1, Gold, TH	6x1 Header	TSW-106-07-G-S	Semtec
J3, J10, J12	3		Header, 100mil, 5x1, Gold, TH	5x1 Header	HTSW-105-07-G-S	Semtec

**Table 3-1. LEDMCUEVM-132 Bill of Materials (continued)**

Designator	Qty	Value	Description	Package	Part Number	Manufacturer
J4, J11	2		Header, 100mil, 4x1, Gold, TH	Header, 100mil, 4x1, TH	TSW-104-07-G-S	Semtec
J5	1		Header, 2.54mm, 10x1, Gold, TH	Header, 2.54mm, 10x1, TH	TSW-110-08-G-S	Semtec
J6	1		Receptacle, 2.54mm, 10x2, Gold, R/A, TH	Receptacle, 2.54mm, 10x2, R/A, TH	SSW-110-02-G-D-RA	Semtec
J7	1		Header (Shrouded), 1.27mm, 5x2, Gold, SMT	Header(Shrouded), 1.27mm, 5x2, SMT	FTSH-105-01-F-DV-K	Semtec
J8	1		Header, 100mil, 10x1, Gold, TH	10x1 Header	TSW-110-07-G-S	Semtec
J9	1		Receptacle, 100mil, 7x2, Gold, R/A, TH	Receptacle, 7x2, 2.54mm, R/A, TH	SSW-107-02-G-D-RA	Semtec
J13, J14, J15	3		Header, 100mil, 2x1, Tin, TH	Header, 2 PIN, 100mil, Tin	PEC02SAAN	Sullins Connector Solutions
L1, L2	2	51 $\mu$ H	Coupled inductor, 51 $\mu$ H, A, 0.14 ohm, SMD	7.1x6mm	B82793S513N201	TDK
R1	1	1.0Meg	RES, 1.0 M, 5%, 0.1 W, AEC-Q200 Grade 0	0603	CRCW06031M00JNEA	Vishay-Dale
R2	1	51 k	RES, 51 k, 5%, 0.063 W, AEC-Q200 Grade 0	0402	CRCW040251K0JNED	Vishay-Dale
R3	1	30 K	RES, 30 k, 5%, 0.063 W, AEC-Q200 Grade 0	0402	CRCW040230K0JNED	Vishay-Dale
R4, R32	2	4.75 K	RES, 4.75 k, 1%, 0.1 W, AEC-Q200 Grade 0	0603	CRCW06034K75FKEA	Vishay-Dale
R5, R6, R18, R19, R20, R21, R28, R29	8	0	RES, 0, 5%, 0.1 W, AEC-Q200 Grade 0	0402	ERJ-2GE0R00X	Panasonic
R7, R9, R38, R39	4	61.9	RES, 61.9, 1%, 0.1 W, AEC-Q200 Grade 0	0603	CRCW060361R9FKEA	Vishay-Dale
R8, R14, R15, R16, R17, R23, R33, R34	8	10 k	RES, 10 k, 5%, 0.063 W, AEC-Q200 Grade 0	0402	CRCW040210K0JNED	Vishay-Dale
R10, R40	2	0	RES, 0, 5%, 0.063 W	0402	MCR01MZPJ000	Rohm
R11	1	5.60 k	RES, 5.60 k, 1%, 0.1 W, AEC-Q200 Grade 0	0603	ERJ3EKF5601V	Panasonic
R12	1	10 k	RES, 10.0 k, 1%, 0.1 W, AEC-Q200 Grade 0	0603	CRCW060310K0FKEA	Vishay-Dale
R13, R41	2	100	100 Ohms $\pm$ 1% 0.125W, 1/8W Chip Resistor 0603 (1608 Metric) Automotive AEC-Q200, Moisture Resistant Thick Film	0603	RK73H1JTTD1000F	KOA Speer
R22	1	1 M	RES, 1.0 M, 5%, 0.063 W, AEC-Q200 Grade 0	0402	CRCW04021M00JNED	Vishay-Dale
R24	1	4.87 k	RES, 4.87 k, 1%, 0.063 W, AEC-Q200 Grade 0	0402	CRCW04024K87FKED	Vishay-Dale
R25	1	100	RES, 100, 5%, 0.063 W, AEC-Q200 Grade 0	0402	CRCW0402100RJNED	Vishay-Dale
R26, R27	2	390	RES, 390, 5%, 0.063 W, AEC-Q200 Grade 0	0402	CRCW0402390RJNED	Vishay-Dale

**Table 3-1. LEDMCUEVM-132 Bill of Materials (continued)**

Designator	Qty	Value	Description	Package	Part Number	Manufacturer
R30	1	51	RES, 51, 5%, 0.063 W, AEC-Q200 Grade 0	0402	CRCW040251R0JNED	Vishay-Dale
R31	1	2.0 k	RES, 2.0 k, 5%, 0.063 W, AEC-Q200 Grade 0	0402	CRCW04022K00JNED	Vishay-Dale
RESET_SW1, Wake_SW1	2		SWITCH TACTILE SPST-NO 0.05A 12V, SMT	3.5x1.35x3.55mm	PTS840 PM SMTR LFS	C&K Components
TP6, TP7, TP9, TP10, TP11, TP12	6		Test Point, Miniature, Black, TH	TH	5001	Keystone
TP20, TP21, TP22, TP24, TP25	5		Terminal, Turret, TH, Double	TH	1502-2	Keystone
U1	1		Single Output High PSRR LDO, 1 A, Adjustable 1.2 to 5.5 V Output, 2.7 to 5.5 V Input, 8-pin SON (DRB), -40 to 125 degC, Green (RoHS & no Sb/Br)	DRB0008B	TPS79601DRBR	Texas Instruments
U2	1		4-Channel USB ESD Solution with Power Clamp	DRY0006A	TPD4S012DRYR	Texas Instruments
U3	1		MSP432E401YTPDT, (TQFP-128)	PDT0128A	MSP432E401YTPDT	Texas Instruments
U4	1		High Speed, Robust EMC, Reinforced Six-Channel Digital Isolator	DBQ0016A	ISO7762DBQR	Texas Instruments
U5, U7	2		Automotive Fault Protected CAN Transceiver With Flexible Data-Rate	D0008A	TCAN1042VDRQ1	Texas Instruments
U6	1		Miniature, 1 W Isolated Regulated DC-DC Converter, -40 to 85 degC, 12-pin SOP	DVB0012A	DCR010505U	Texas Instruments
U8, U10	2		High-speed, robust EMC six-channel digital isolator	DBQ0016A	ISO7760FDBQR	Texas Instruments
U9	1		High Speed, Robust EMC, Reinforced Six-Channel Digital Isolator	DBQ0016A	ISO7761DBQR	Texas Instruments
U11	1		Low-Capacitance 6-Channel +/-15 kV ESD Protection Array for High-Speed Data Interfaces	RSE0008A	TPD6E004RSER	Texas Instruments
Y1	1		Crystal, 32.768 kHz, SMD	D1.9xL6mm	CMR200T-32.768KDZY-UT	Citizen FineDevice
Y2	1		Crystal, 25 MHz, 8pF, SMD	3.2x0.75x2.5mm	NX3225GA-25.000M-STD-CRG-2	NDK

## 4 Software

This section describes the installation of the GUI software, the necessary drivers to operate the [LEDMCUEVM-132](#).

### 4.1 Demonstration Kit Software Installation for LEDMCUEVM-132 Board

#### 4.1.1 Installation Overview

This is a summary of the installation steps. To see step-by-step instructions with screen shots, see [Section 4.2](#).

1. Click on *TPS92518, 520, 682 LaunchPad™ Evaluation Software Installer.exe*
2. Right click, and choose **Run As Administrator**
3. Click **yes** when *Windows Account Control* asks to allow the program to make changes to the computer
4. Click **I Agree** to the installation license terms and install in the recommended location

Installation will take a few minutes, as it may need to install Microsoft® .NET Framework®. If the installer asks if you wish to reboot after installing Microsoft .NET, you must click **Restart Later** and allow the driver installation to complete.

After running the *TPS92518, 520, 682 LaunchPad Evaluation Software Installer.exe*, the evaluation software window appears as shown in [Figure 4-1](#).

#### 4.2 Step-by-Step Installation Instructions

This section shows the detailed installation instructions with screen shots.

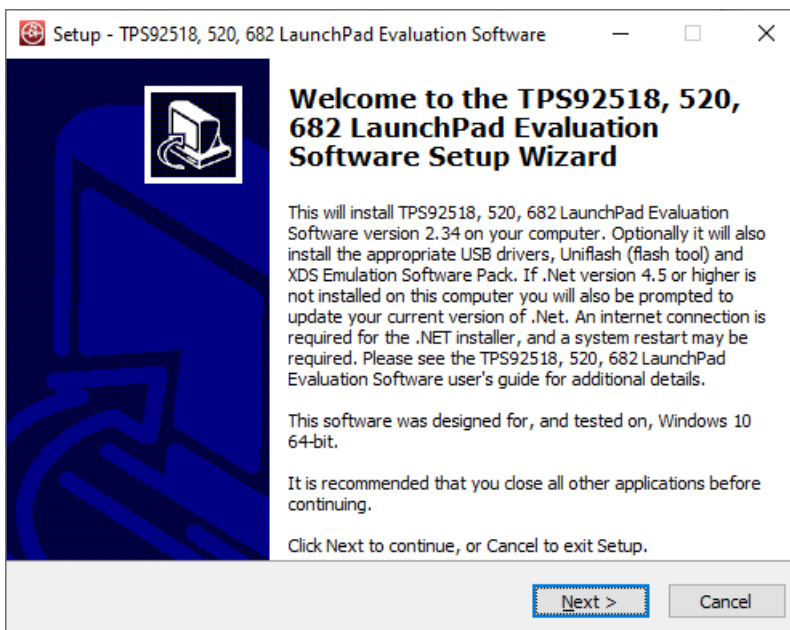
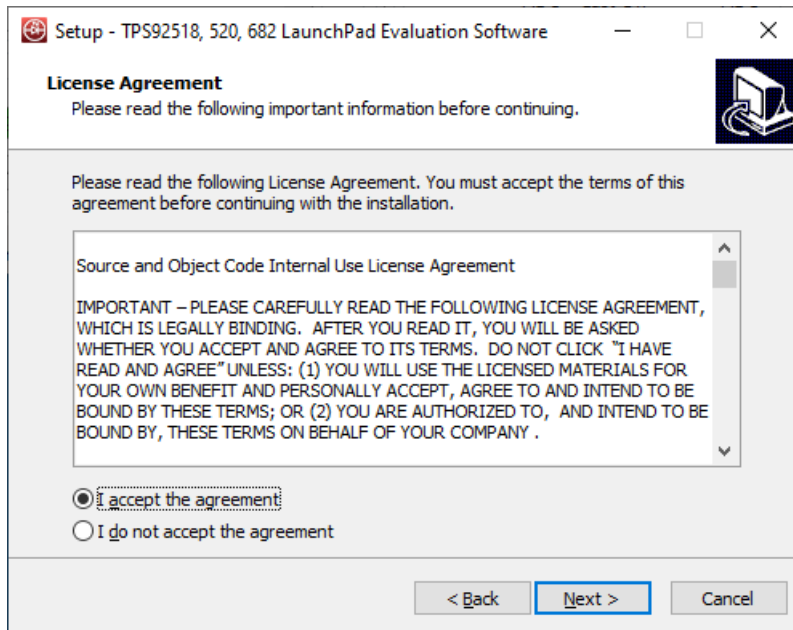


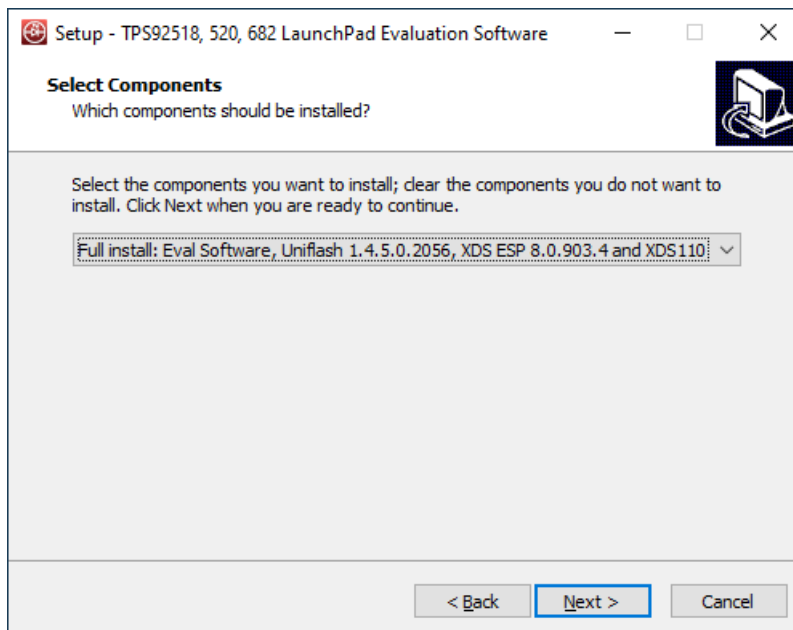
Figure 4-1. Setup Screen 1

Click **Next >** to install.



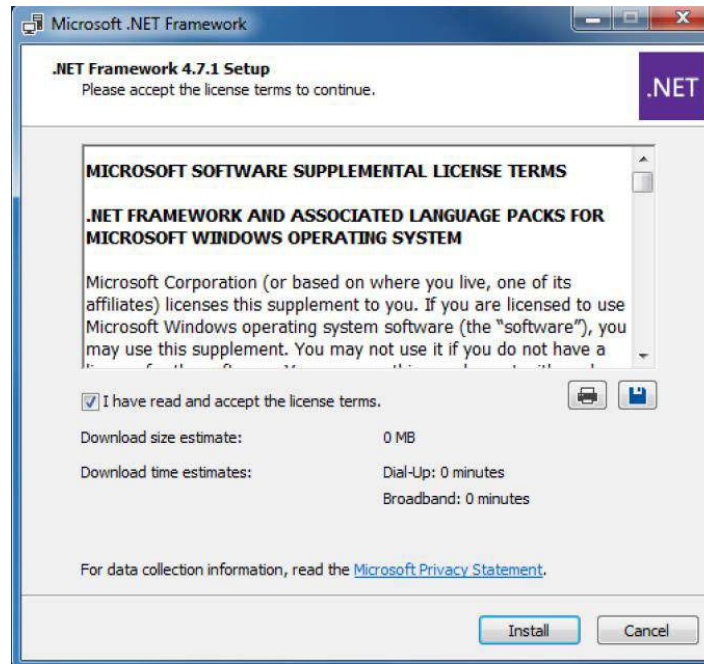
**Figure 4-2. Setup Screen 2**

Click **Next >** to accept the License Agreement.



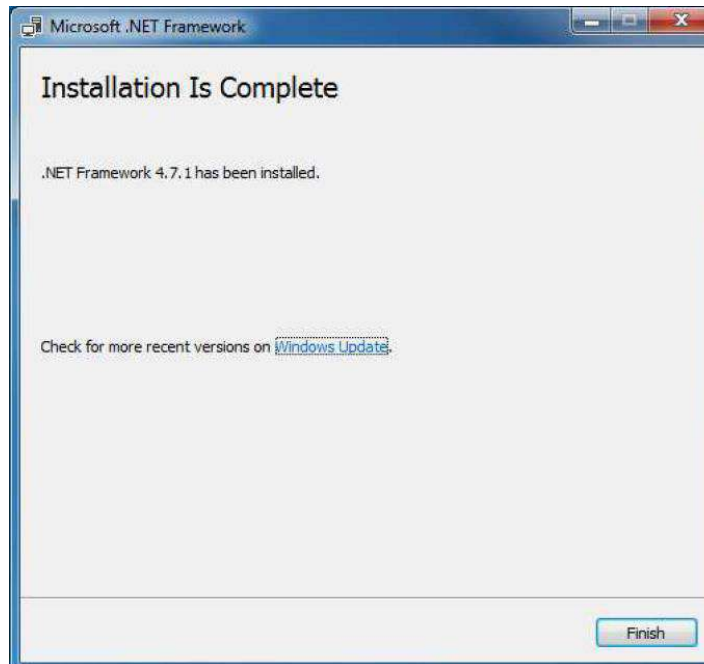
**Figure 4-3. Setup Screen 3**

Select **Full Install** and click **Next >** to install the evaluation software, the UniFlash, and the required XDS drivers. Full installation for both Microsoft® Windows® 10 and Microsoft® Windows® 7 are provided.



**Figure 4-4. Setup Screen 4**

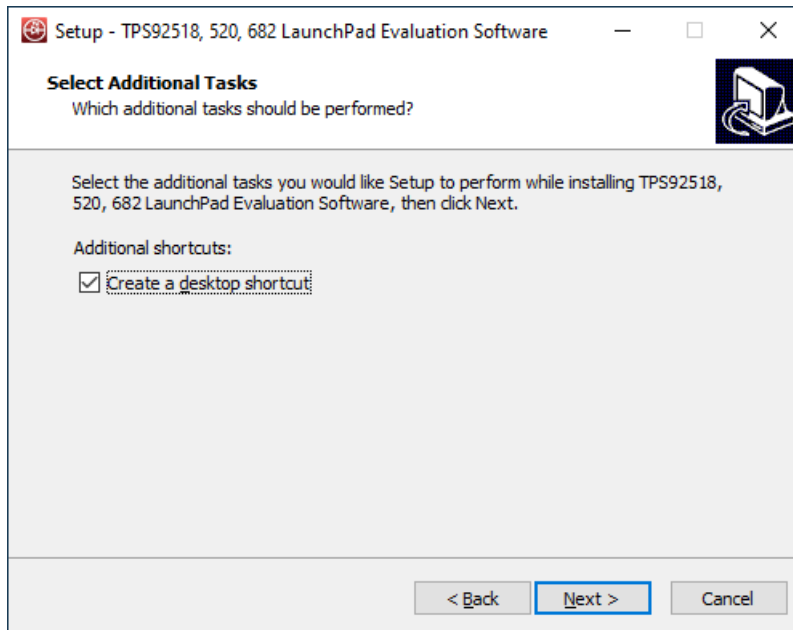
If Microsoft® .NET Framework 4.5 or higher does not exist on the computer, the .NET Framework installation begins. Installation of .NET Framework will take several minutes. If the .NET Framework 4.5 or higher exists on the computer, the installation jumps to the XDS driver installation.



**Figure 4-5. Setup Screen 5**

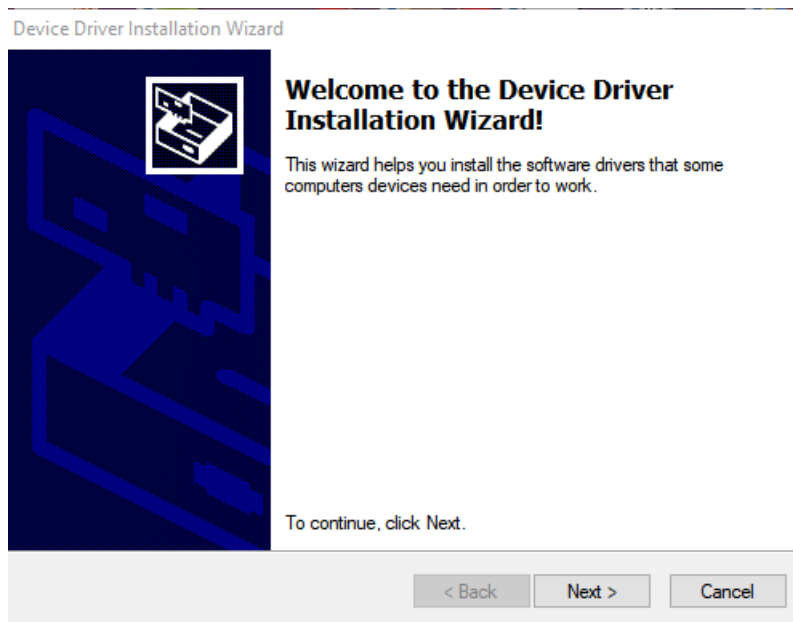
A window appears indicating the completion of the .NET Framework installation.





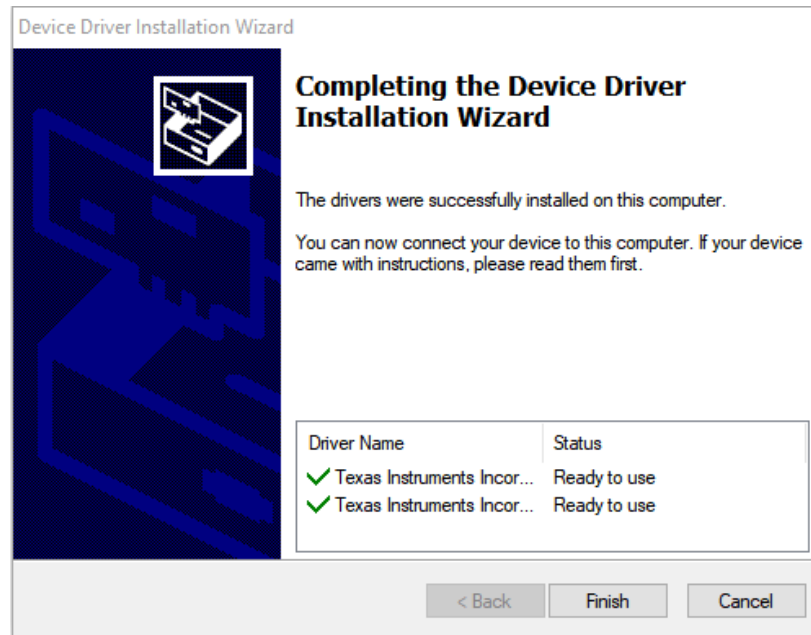
**Figure 4-6. Setup Screen 6**

Click the **Next >** to proceed.



**Figure 4-7. Setup Screen 7**

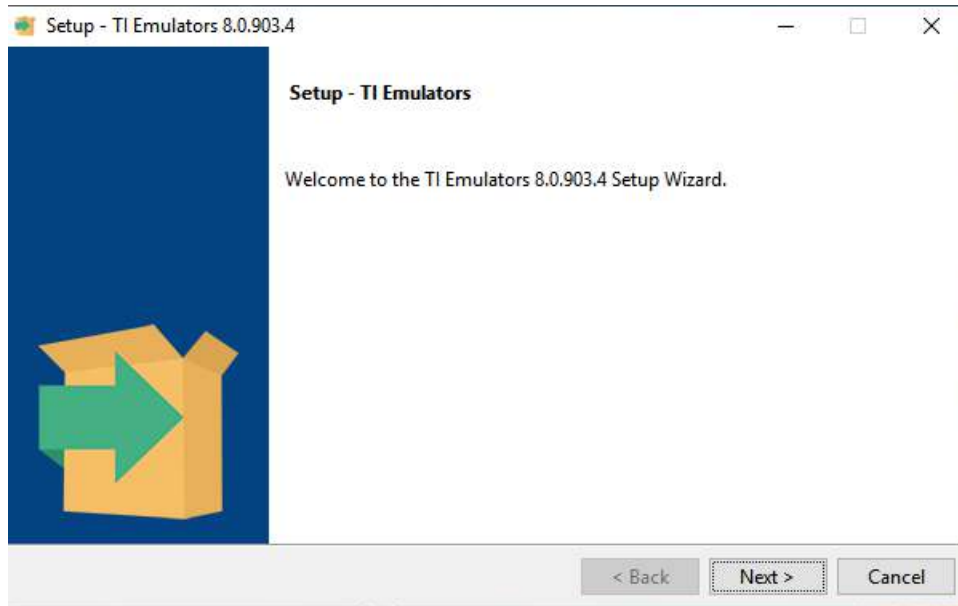
Click the **Next >** button to install the XDS driver.



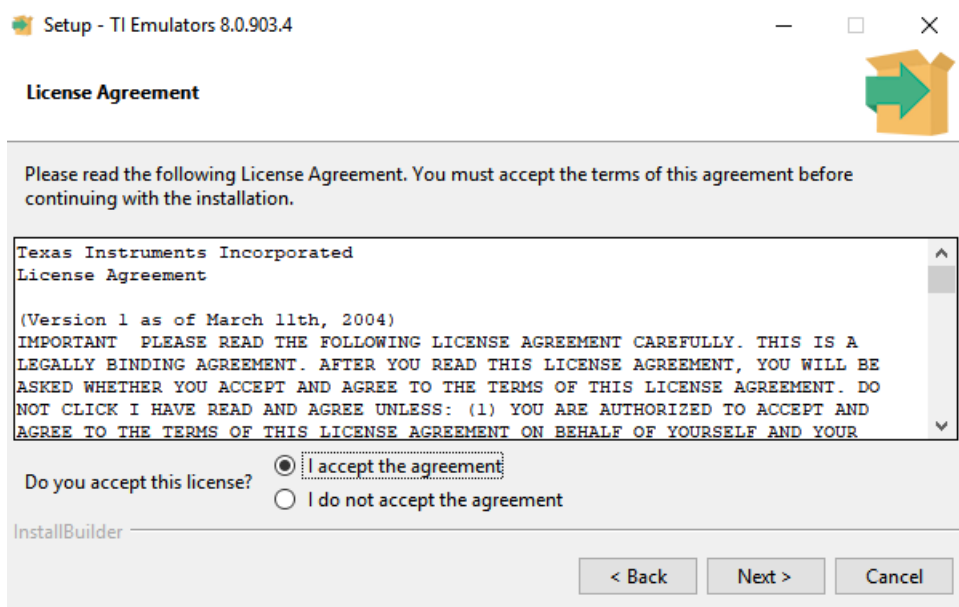
**Figure 4-8. Setup Screen 8**

Figure 4-8 shows the completion of the XDS driver installation.

The TI-Emulators installation starts at this point. This will install the necessary drivers for running the application. In the next few steps (as shown in Figure 4-9, Figure 4-10, and Figure 4-11) click **Next >** to perform the installation.

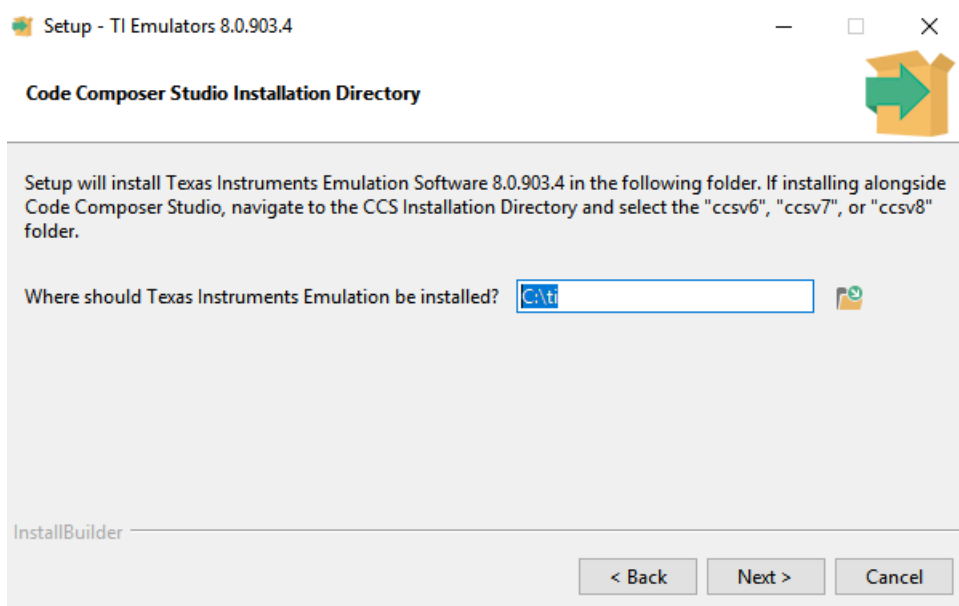


**Figure 4-9. Setup Screen 9**



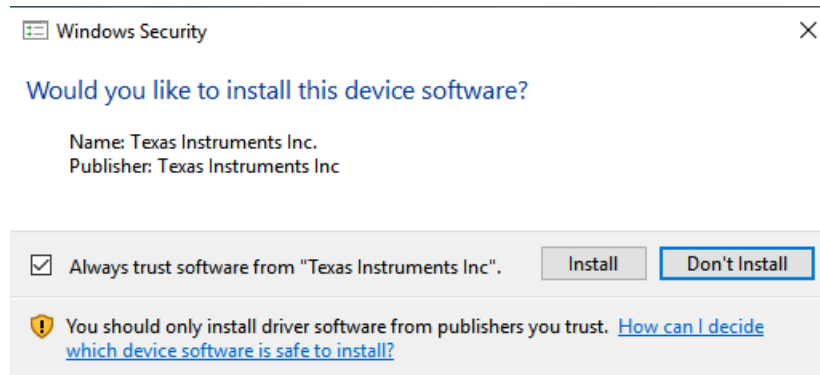
**Figure 4-10. Setup Screen 10**

Accept the license agreement in [Figure 4-10](#).

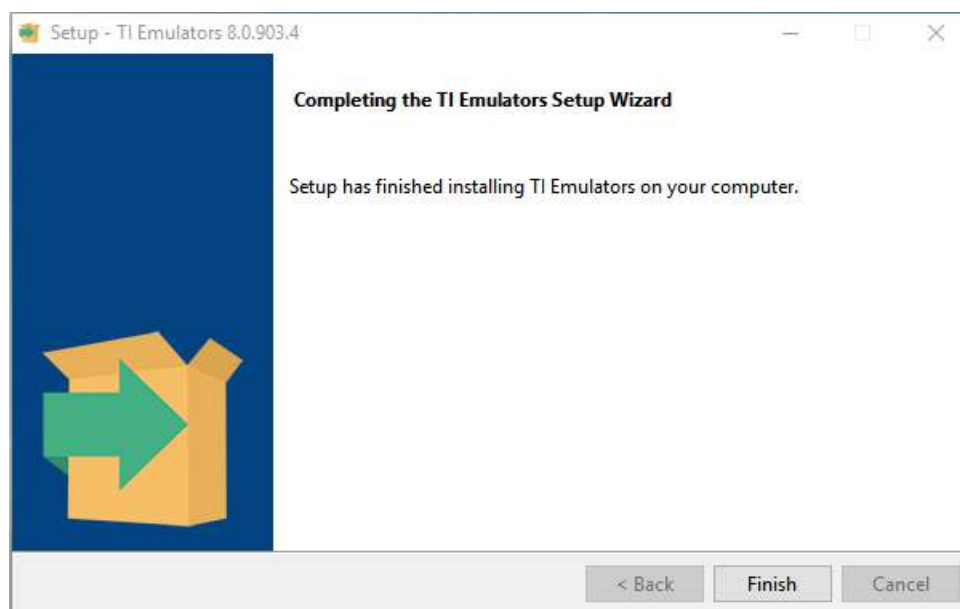


**Figure 4-11. Setup Screen 11**

In the next few windows click **Next >**, and if prompted by Windows Security about software installation as shown in [Figure 4-12](#), select **Install**.



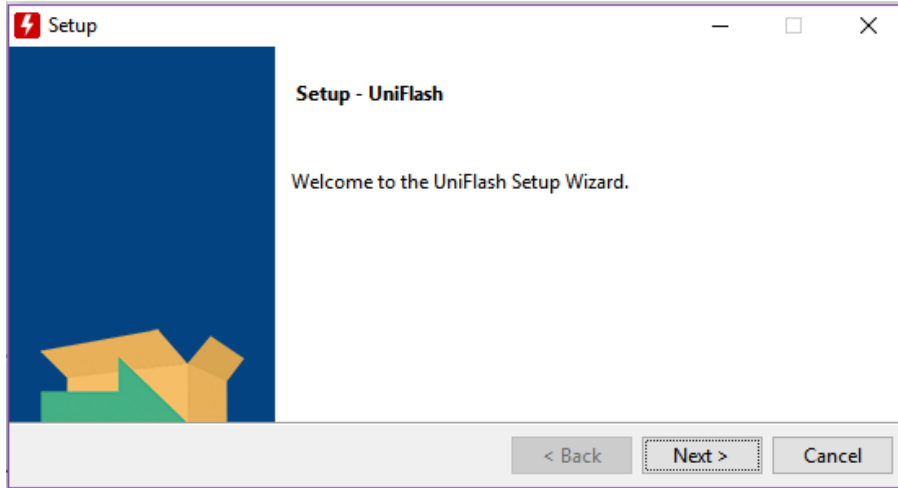
**Figure 4-12. Setup Screen 12**



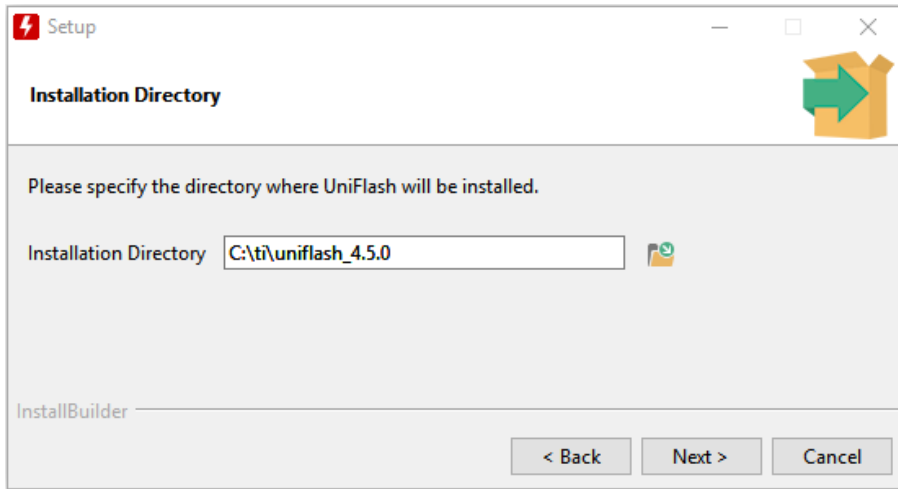
**Figure 4-13. Setup Screen 13**

The screen showing the completion of the TI Emulators installation is shown in [Figure 4-13](#). Click on **Finish** to move to the next step.

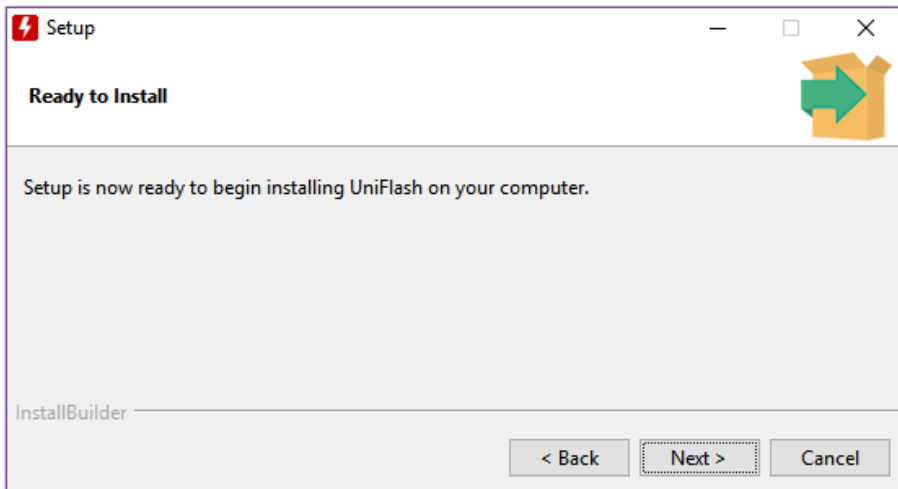
The UniFlash installation starts at this point. UniFlash is required to program the LaunchPad. In the next few steps as shown in [Figure 4-14](#), [Figure 4-15](#), and [Figure 4-16](#) click **Next >** to proceed and start the installation.



**Figure 4-14. Setup Screen 14**



**Figure 4-15. Setup Screen 15**



**Figure 4-16. Setup Screen 16**

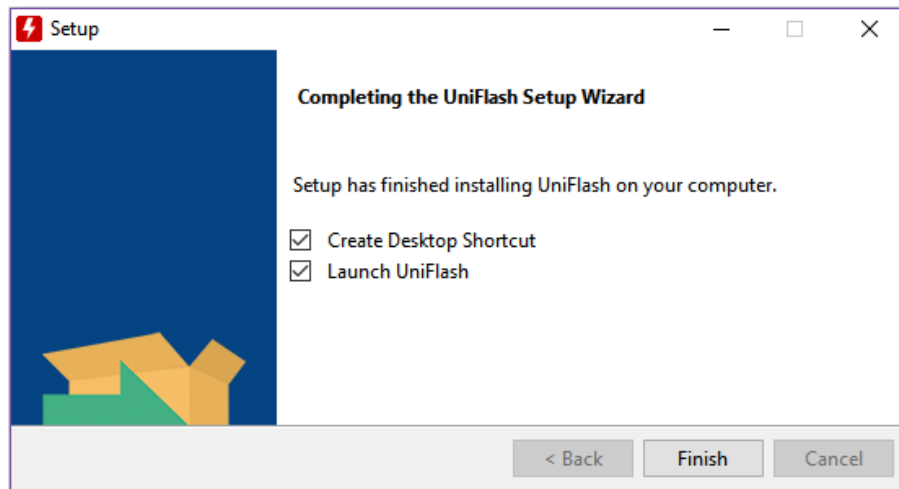


Figure 4-17. Setup Screen 17

When UniFlash installation is complete, click the **Finish** button to launch the UniFlash and program the LaunchPad.

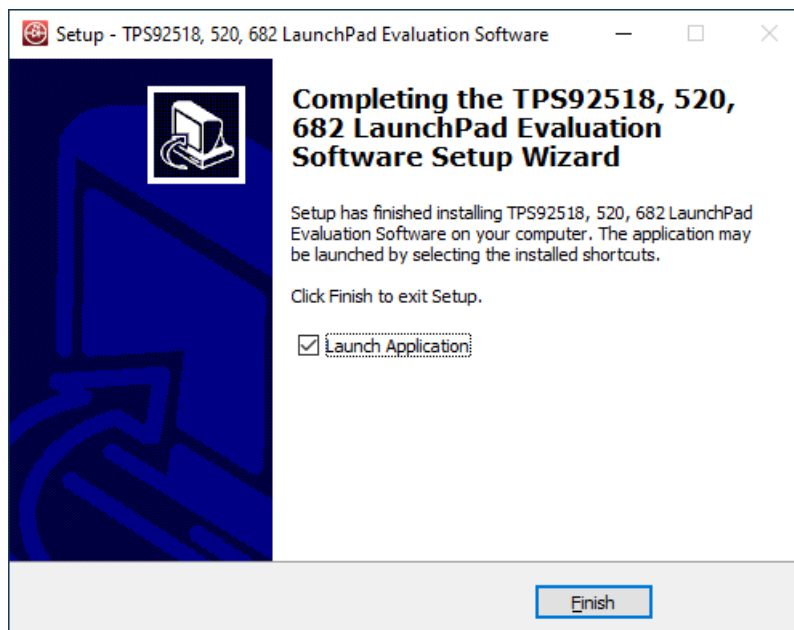


Figure 4-18. Setup Screen 18

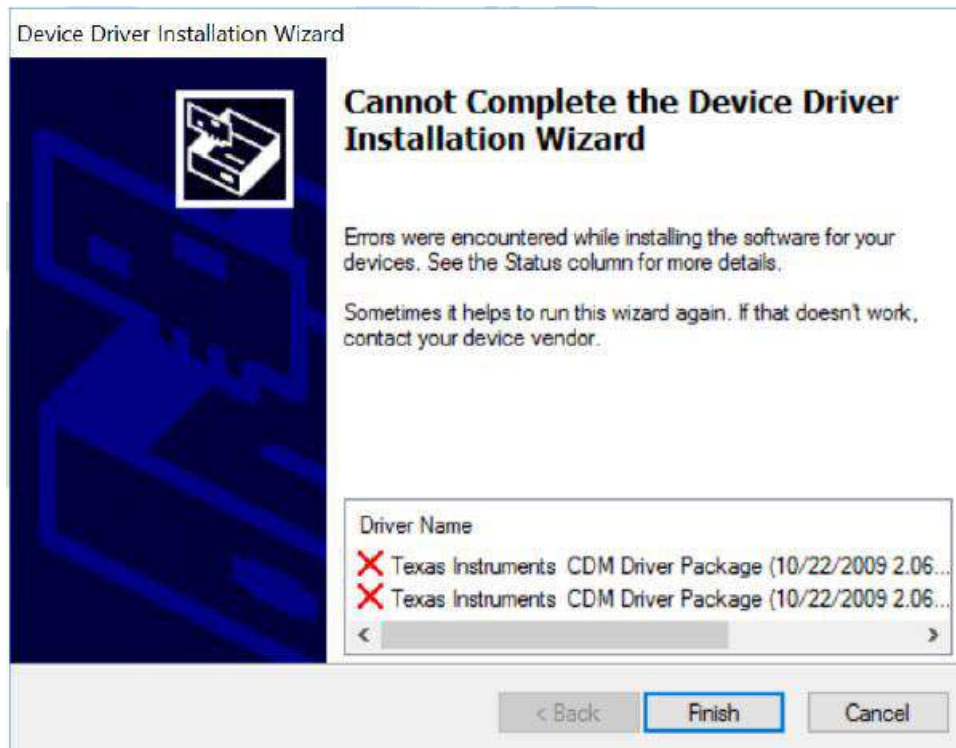
Figure 4-18 shows the completion of the TPS92520-Q1 Evaluation Software . Un-check **Launch Application** and click the **Finish** button.

### 4.3 Installation Error Recovery

If the screen shown in [Figure 4-19](#) appears, use the following steps (one time) to install an unsigned driver.

1. Click **Start** and select **Settings**
2. Click **Update and Security**
3. Click **Recovery**
4. Click **Restart Now** under **Advanced Start-up**
5. Click **Troubleshoot**
6. Select **Advanced Options**
7. Select **Start-up Settings**
8. Click **Restart**
9. On the **Start-up Settings** screen, press F7 during reboot to disable driver signature enforcement. The host computer restarts.
10. Repeat the entire re-installation process
11. A message appears informing that installing the .NET Framework failed. Close that window and continue.
12. Double-click **Install unsigned drivers**

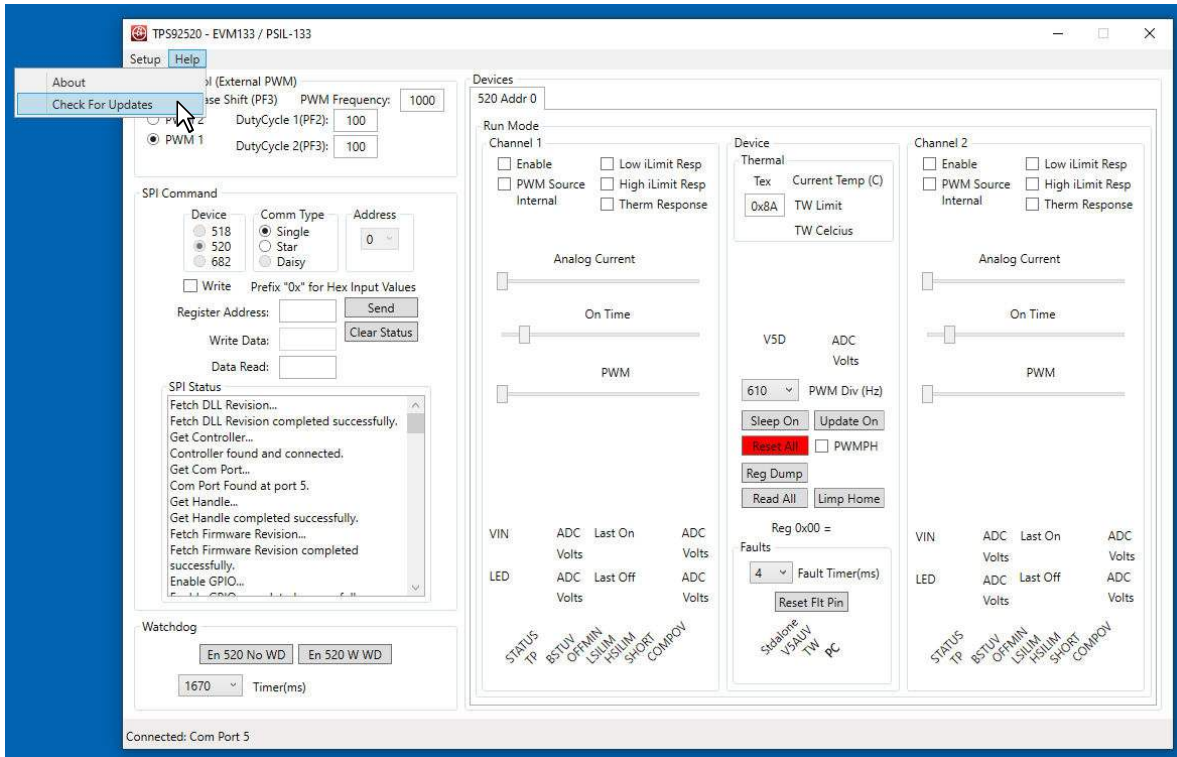
After restarting a second time, the host computer resets. The reset requires all drivers to be digitally signed the next time a default installation executes, unless these steps are repeated.



**Figure 4-19. Setup Screen 19**

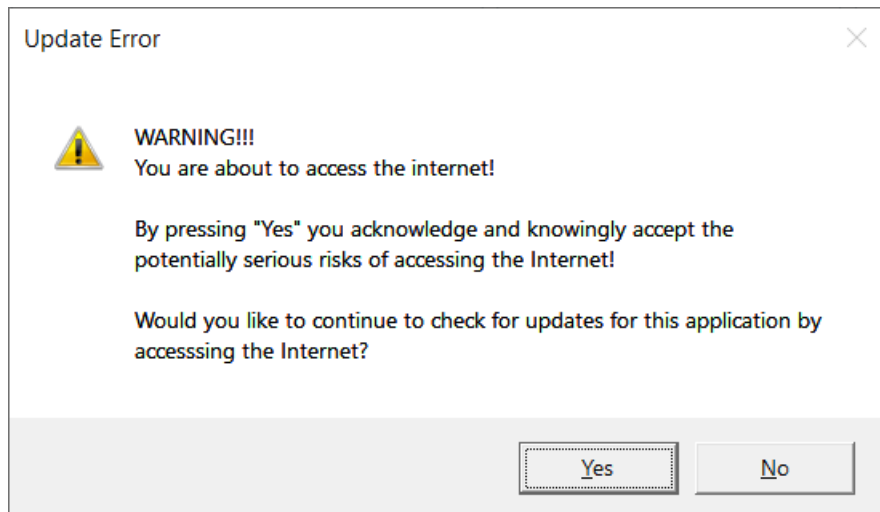
## 4.4 Checking for Updates

This section shows the detailed instructions for checking if there is an update and how to install it. Run the TPS92518, 520, 682 LaunchPad Evaluation Software and go to the **Help** menu, see [Figure 4-20](#).



**Figure 4-20. Help Menu and Checking for Updates**

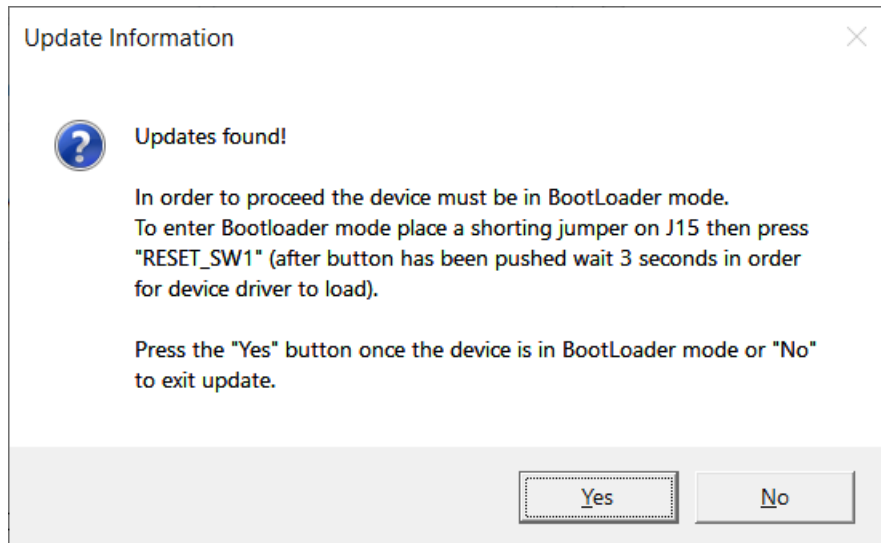
Click **Check for Updates >** to run updater.



**Figure 4-21. Update Screen 1**

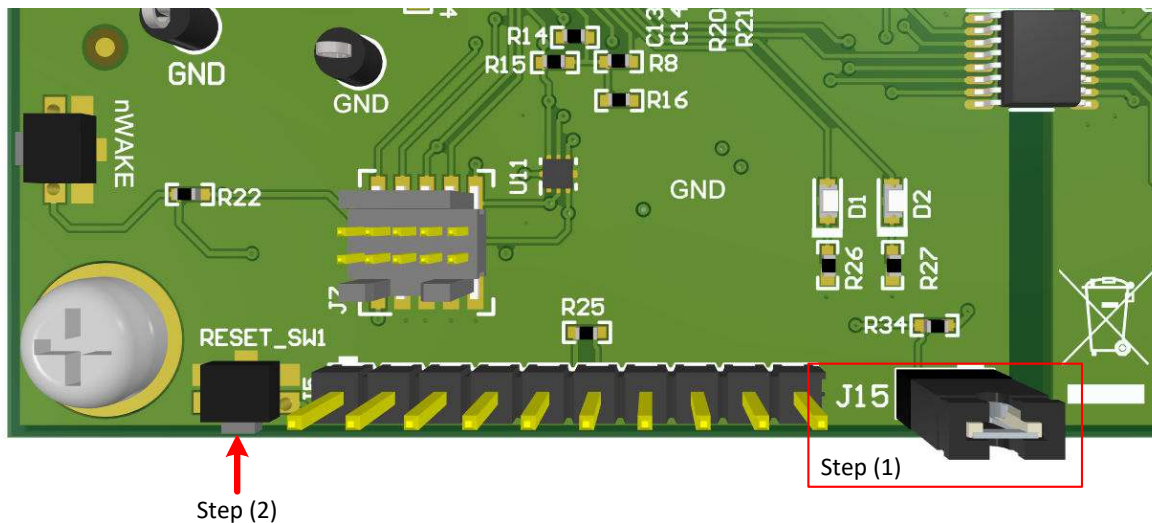
Click the **Yes** button to accept risks for accessing the Internet.





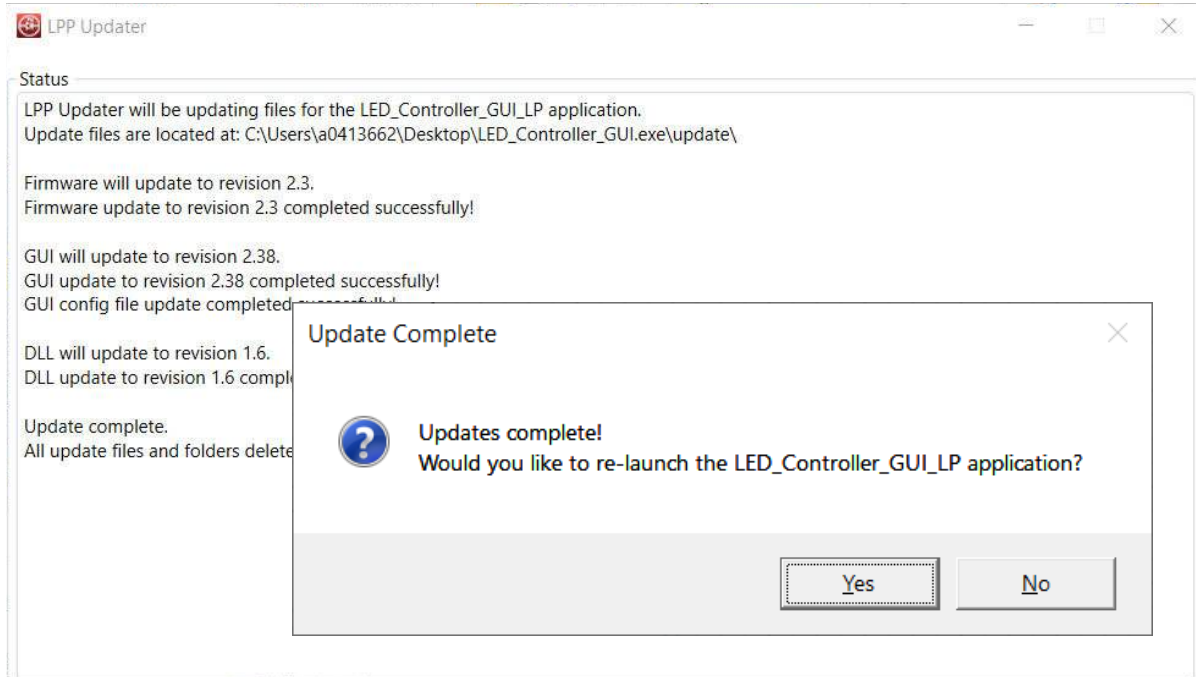
**Figure 4-22. Update Screen 2**

Go to the [LEDMCUEVM-132](#) (PSIL-132) and locate J15 and **RESET\_SW1**. Install shorting jumper at J15 locations as illustrated and then press the **RESET\_SW1** as [Figure 4-23](#) shows. This places the MCU in Bootloader mode.



**Figure 4-23. J15 Jumper and RESET\_SW1 Switch for Bootloader Mode**

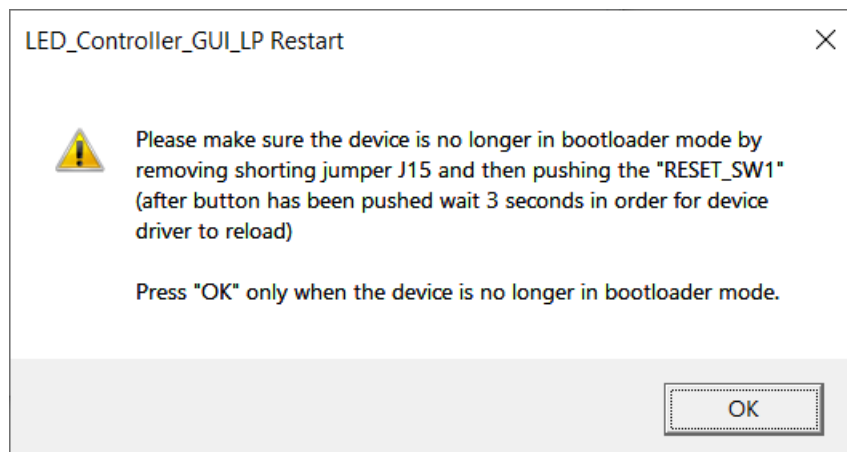
Click the **Yes** button to run the updater. The **LPP Updater** will run and once finished will ask if you would like to re-launch the GUI applications.



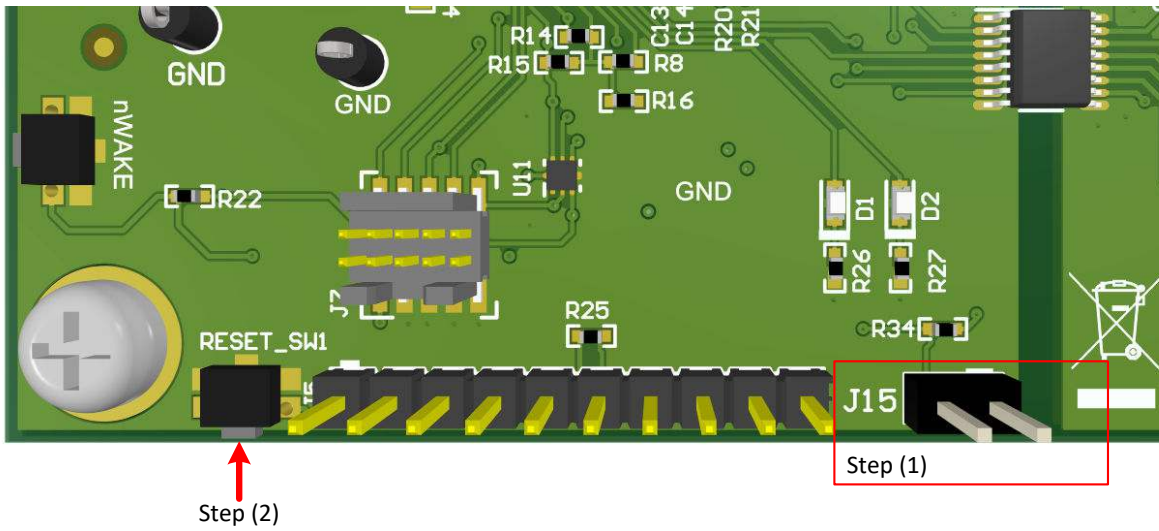
**Figure 4-24. Setup Screen 5**

Click the **Yes** button to re-launch the GUI.

A window appears indicating the the [LEDMCUEVM-132](#) must be changed from bootloader mode to normal mode. This is accomplished by removing the shorting jumper from J15 then pressing the **RESET\_SW1** switch and wait 3 seconds to ensure device drivers reload, see [Figure 4-26](#).



**Figure 4-25. Setup Screen 6**

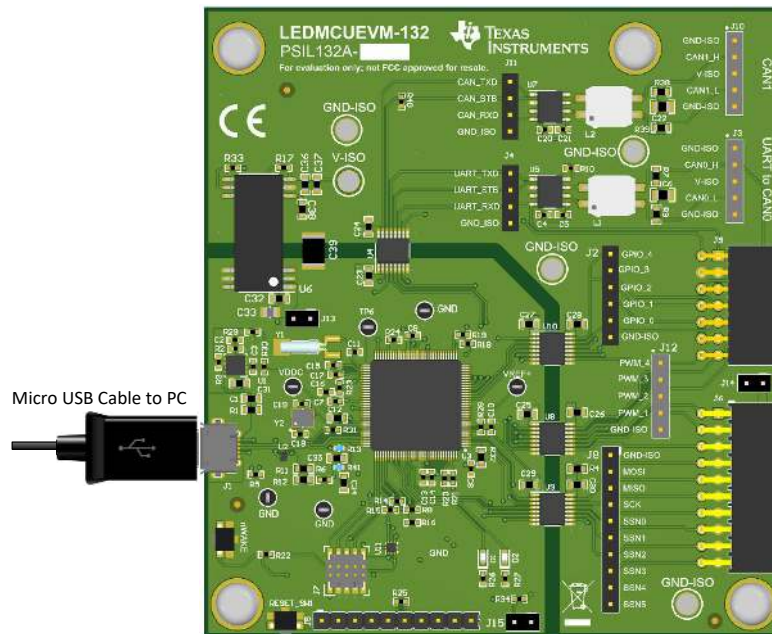


**Figure 4-26. J15 Jumper and RESET\_SW1 Switch for Normal Mode**

Click the **OK** button to restart the GUI.

## 5 LEDMCUEVM-132 Power UP and Operation

To start the EVM operation, connect the USB cable to the computer and the [LEDMCUEVM-132](#).

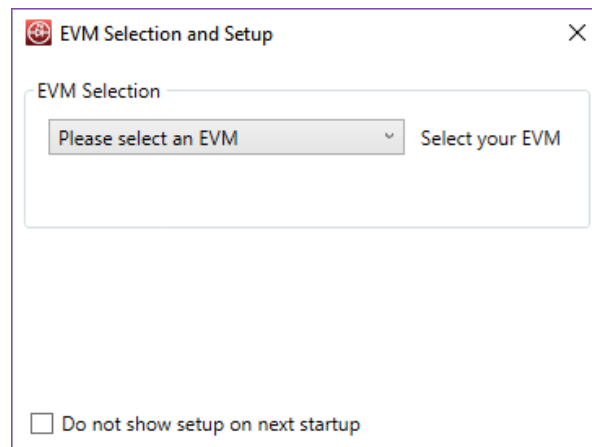


**Figure 5-1. LEDMCUEVM-132 Connection to PC Using USB Cable**

Connect the appropriate mating EVM to header J9 for TPS92518HVEVM-878 and TPS92682EVM-069/70 or J9 + J6 for the TPS92520EVM-133. Connect J3 to TPS92662EVM6-901 to communicate using UART using CAN transceiver. Additional connections and jumper settings may need to be used for the system to work properly. Reference the appropriate EVM user's guide and schematics for detailed information.

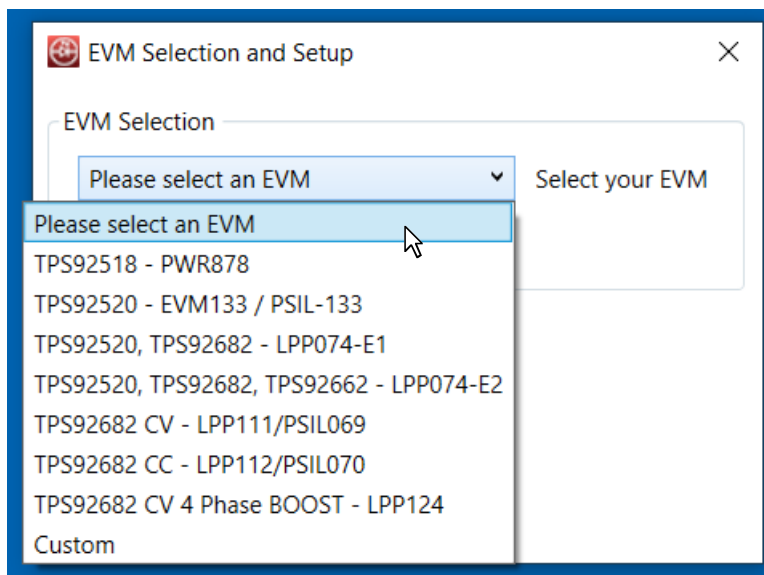
### 5.1 GUI Start-up

Run the program **LED\_Controller\_GUI\_LP.exe**, located at the "*:\Texas Instruments\TPS92518, 520, 682 LaunchPad Evaluation Software*", to start the GUI. The window shown in [Figure 5-2](#) opens. If the *TPS92518, 520, 682 Launchpad Evaluation Software* shortcut was installed on the desktop then that can also be used to run the application.



**Figure 5-2. GUI Setup Screen 1**

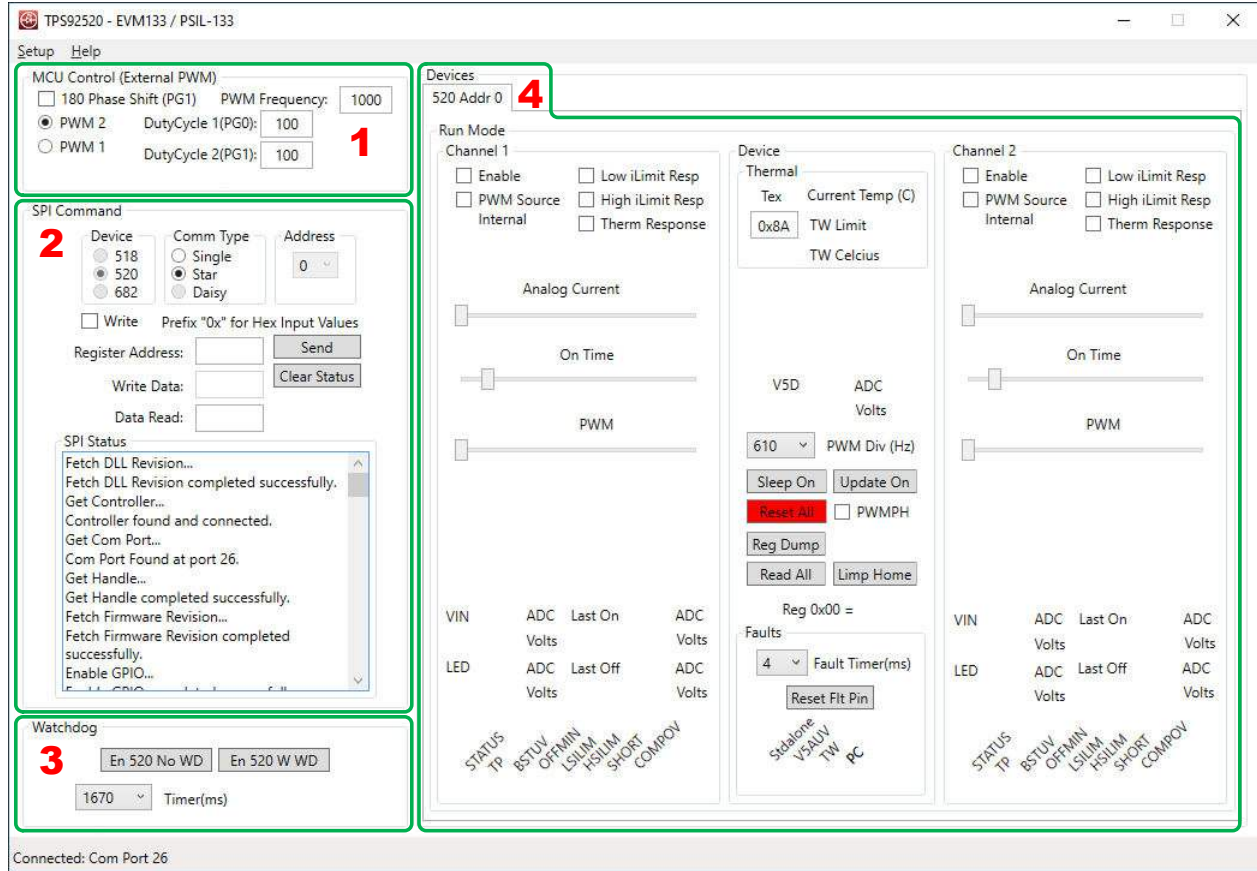
Click the **Please select an EVM** drop-down menu to see the available EVMs that are supported by the LEDMCUEVM-132 and the GUI.



**Figure 5-3. GUI EVM Selection and Setup Screen**

Depending on the selection, either select the number of devices or select the desired device address then click **Add Device**.

The GUI will start up and show 4 separate windows (1-MCU Control, 2-SPI Command, 3-Watchdog (NOTE: not all EVM selections use this feature), and 4-Devices), see [Figure 5-4](#).



**Figure 5-4. TPS92520 - EVM133 GUI Start-up Screen Showing Different Windows**

## 5.2 MCU Control Window

The MCU Control window allows external control of the PWM dimming using the LEDMCUEVM-132 connections to the attached EVM. PWM control is available for each channel with frequency and duty cycle control for frequencies and duty cycles that are not covered by the register settings. It also allows for 180 degree phase shift in between channels if desired. For example, if a PWM signal of 3 kHz was desired, they could use this feature.



Figure 5-5. MCU Control (External PWM) Window

PWM 1 is the first PWM generator from the MCU and controls Duty Cycle 1 at PF2 pin of MCU and Duty Cycle 2 at PF3 pin of the MCU. PWM1-DutyCycle 1 coincides with PWM\_1 on the EVM and PWM1-DutyCycle 2 coincides with PWM\_2 of the EVM, see Figure 5-6. Furthermore, The PWM frequency of PMW 1 generator is the same for both PWM\_1 and PWM\_2 and is separate from PWM 2 generator, which controls PWM\_3 and PWM\_4 on the EVM.

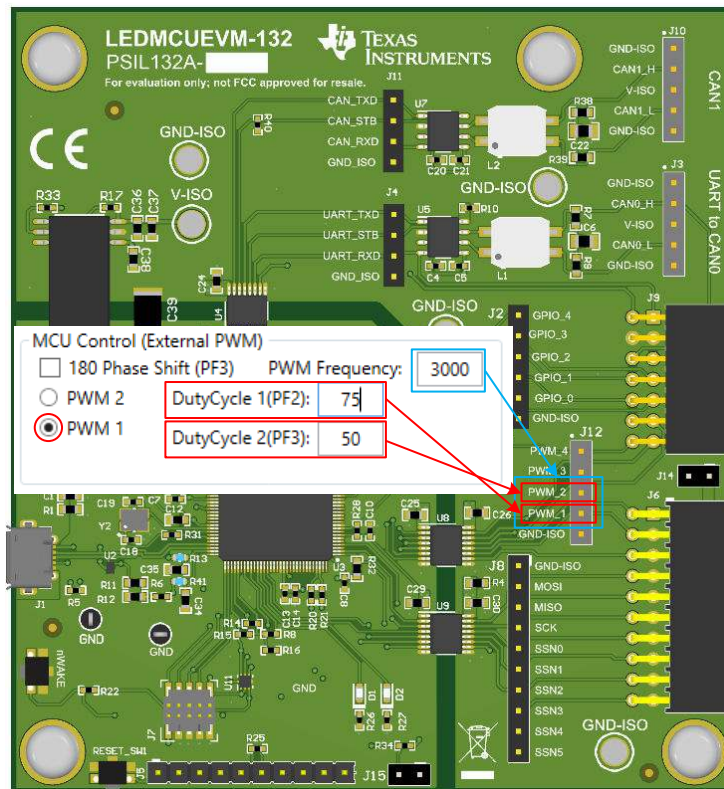
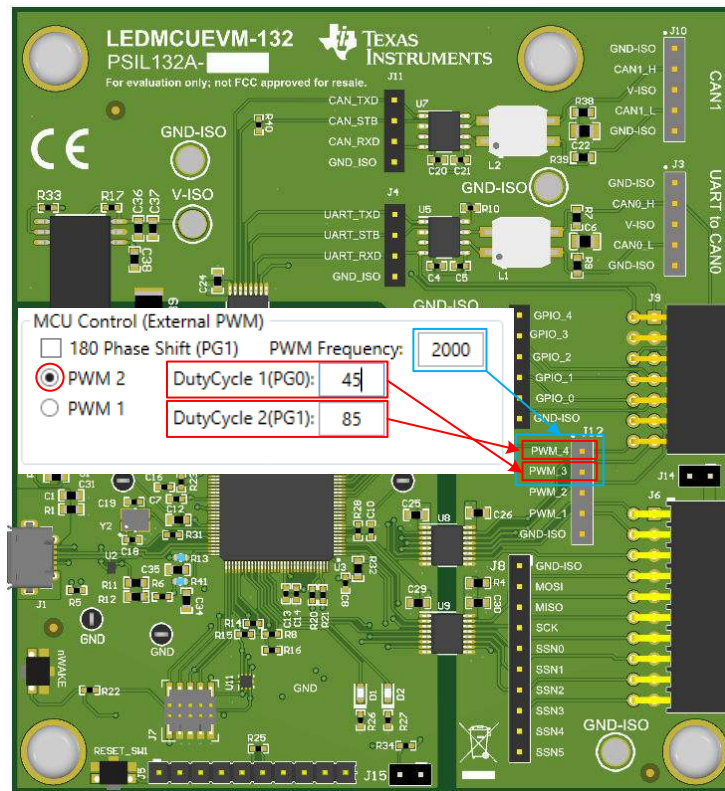


Figure 5-6. MCU External PWM for PWM\_1 and PWM\_2

PWM 2 is the second PWM generator from the MCU and controls Duty Cycle 1 at PG0 pin of the MCU and Duty Cycle 2 at GP1 pin of the MCU. PWM 2 generator signals connects to PWM\_3 (PG0) and PWM\_4 (PG1) on the attached EVM, see Figure 5-7.



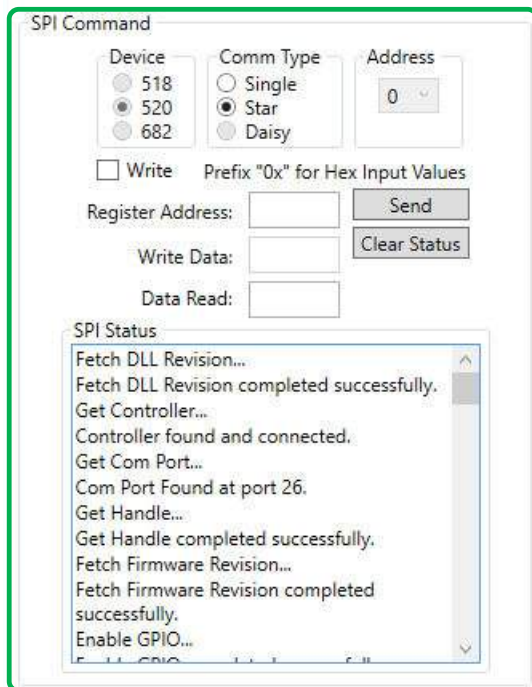
**Figure 5-7. MCU External PWM for PWM\_3 and PWM\_4**

Depending on the EVM, the PWM signals will be mapped to PWM\_1, 2, 3, 4, or some combination of the four. For example, TPS92520EVM-133 uses PWM\_1 and PWM\_2 from the PWM 1 generator of the MCU.



### 5.3 SPI Command Window

The SPI command box allows register *read* and *write* actions and it also records the SPI status sequentially. There are times when specific register settings may want to be controlled directly instead of through the simplified interface of the GUI. The following section is an example of doing reads and writes for when the LEDMCUEVM-132 is connected to the TPS92520EVM-133 to ensure proper communications.

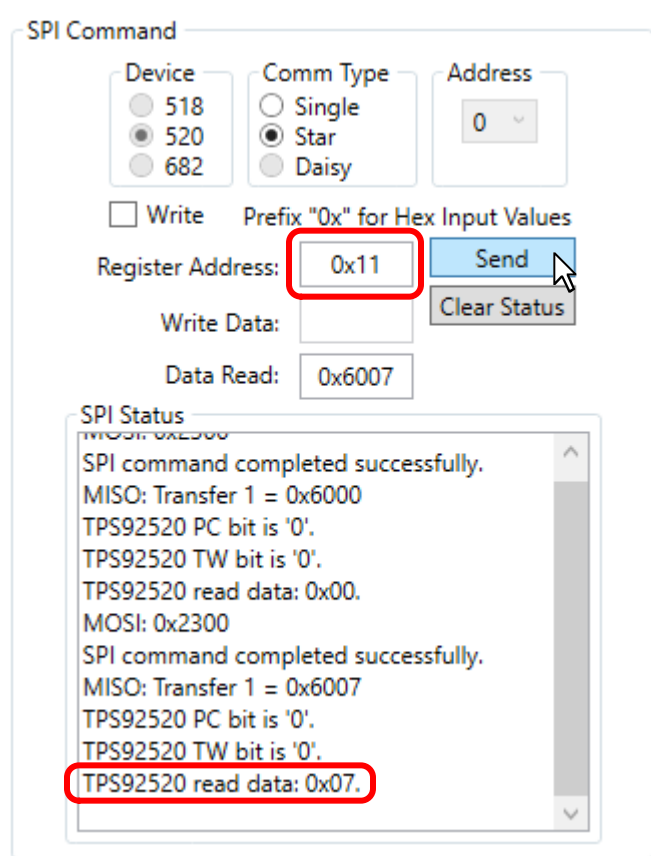


**Figure 5-8. SPI Command Window**

To ensure a connection from the board to the [TPS92520-Q1](#) exists, perform the following steps as shown in [Figure 5-9](#).

1. Write the register address eleven (0x11h), which is the CH1TON register, in the *Register Address* box: 0x11.
2. Double-click the **Send** button.

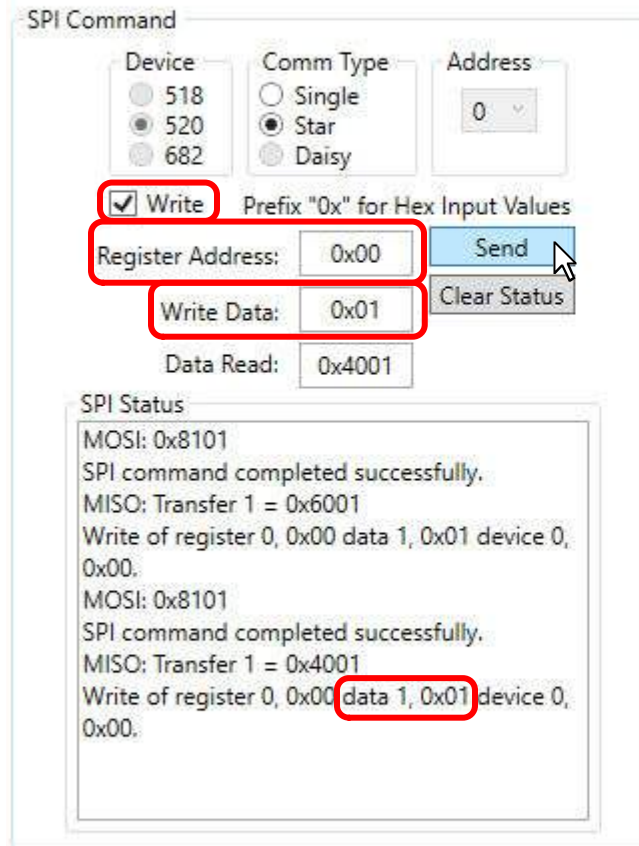
The default value of 0x07 for the register 11 will be shown in the SPI Status window, see [Figure 5-9](#).



**Figure 5-9. SPI Read Example**

To write data to the associated register address here is an example where channel 1 of the TPS92520EVM-133 is enabled using the write command:

- Click the check box next to **Write**
- Write the desired data in the box next to **Write Data:** as shown in [Figure 5-10](#).
- Click **Send**.



**Figure 5-10. SPI Write Example**

## 5.4 GUI Devices Window and Example Connections and Power Up

The device command window is the primary window that is different depending on which EVM is selected from the drop-down menu from the **EVM Selection and Setup** window. Some selections allow you to choose more than one device and a tab is created for each of the devices. The tab also shows the address number of the device as "Addr x". The user's guide for each EVM should be referenced for specific descriptions of the features or the devices and how it is implemented into the GUI.

The LEDMCUEVM-132 can be connected to several LED related EVMs to create your own system within the confines of what the GUI supports for EVMs and devices. Here are a few example **Device** windows, connections, and setups for using the LEDMCUEVM-132 with supported EVMs.

### 5.4.1 TPS92520EVM-133 Connections and Power UP

The TPS92520EVM-133 can be connected to the LEDMCUEVM-132 and use the associated GUI to monitor and control the TPS92520-Q1 device using the SPI bus to read and write commands. Here is a typical setup for controlling and testing the TPS92520EVM-133, note jumper locations are in red, see [Figure 5-11](#).

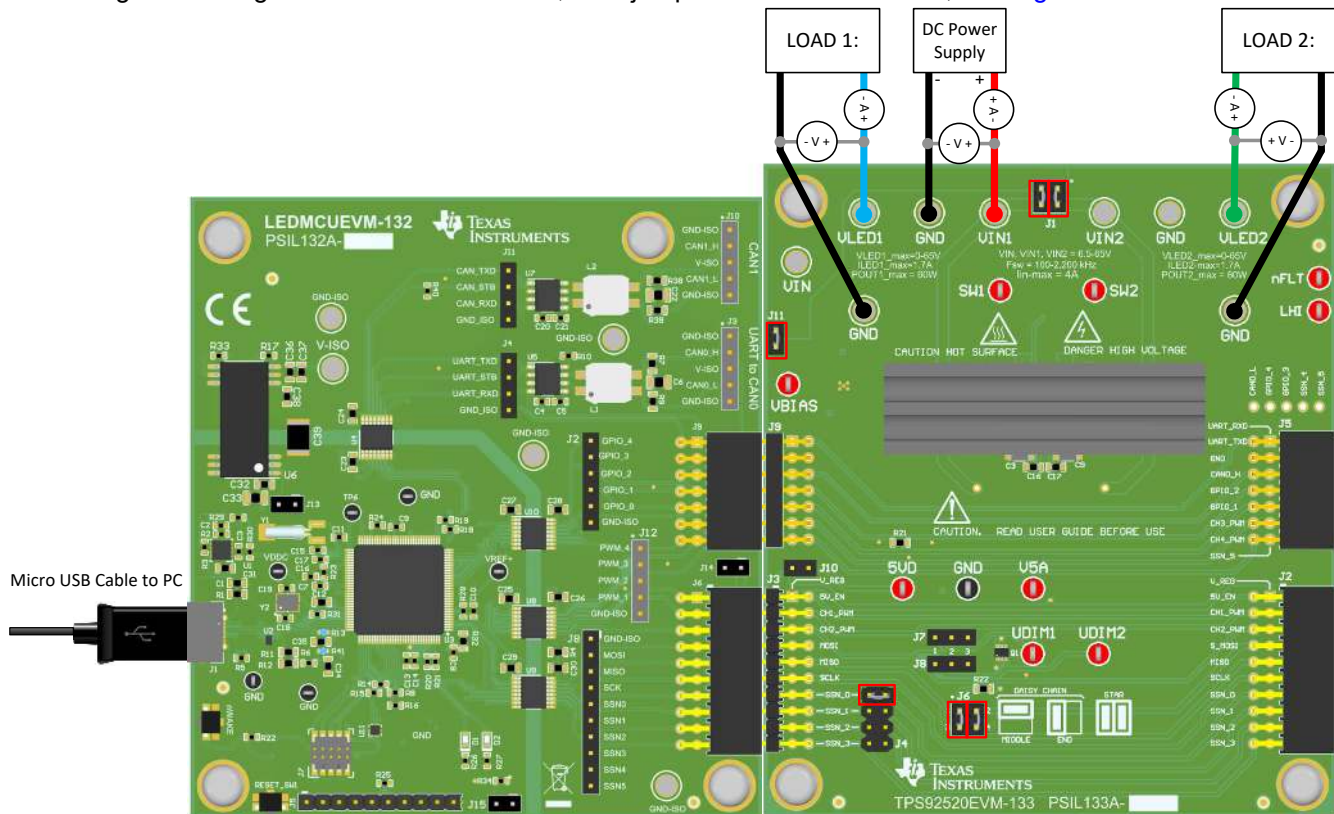


Figure 5-11. LEDMCUEVM-132 + TPS92520EVM-133 Connections and Setup

### 5.4.2 TPS92520EVM-133 Devices Window

When selecting the TPS92520EVM-133 from the **EVM Selection and Setup** window, simply select the **Add Device** button to start the GUI, see [Figure 5-12](#).

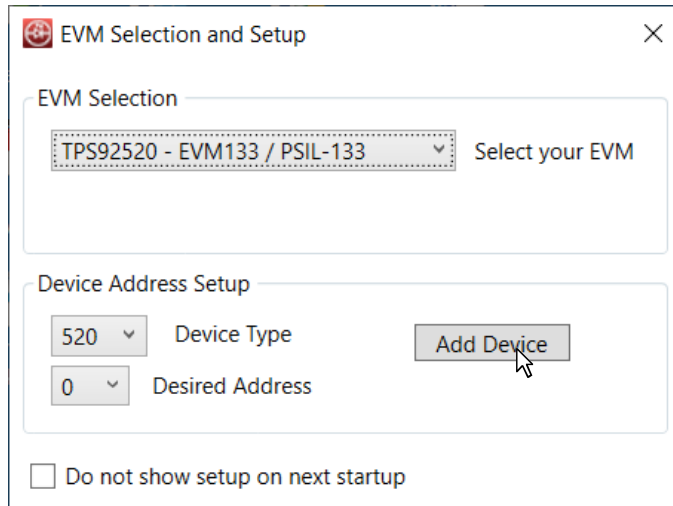


Figure 5-12. TPS92520EVM-133 Menu From EVM Selection and Setup Window

The Devices window of the TPS92520EVM-133 shows separate sub-windows that control each channel with features such as **Analog Current** control, **On Time** control, ADC measurements, and **PWM** duty cycle control along with many other selection boxes, and fault indication boxes, see [Figure 5-13](#). See the TPS92520EVM-133 Users Guide for specifics on the operation of the GUI and how it controls the TPS92520-Q1 device.

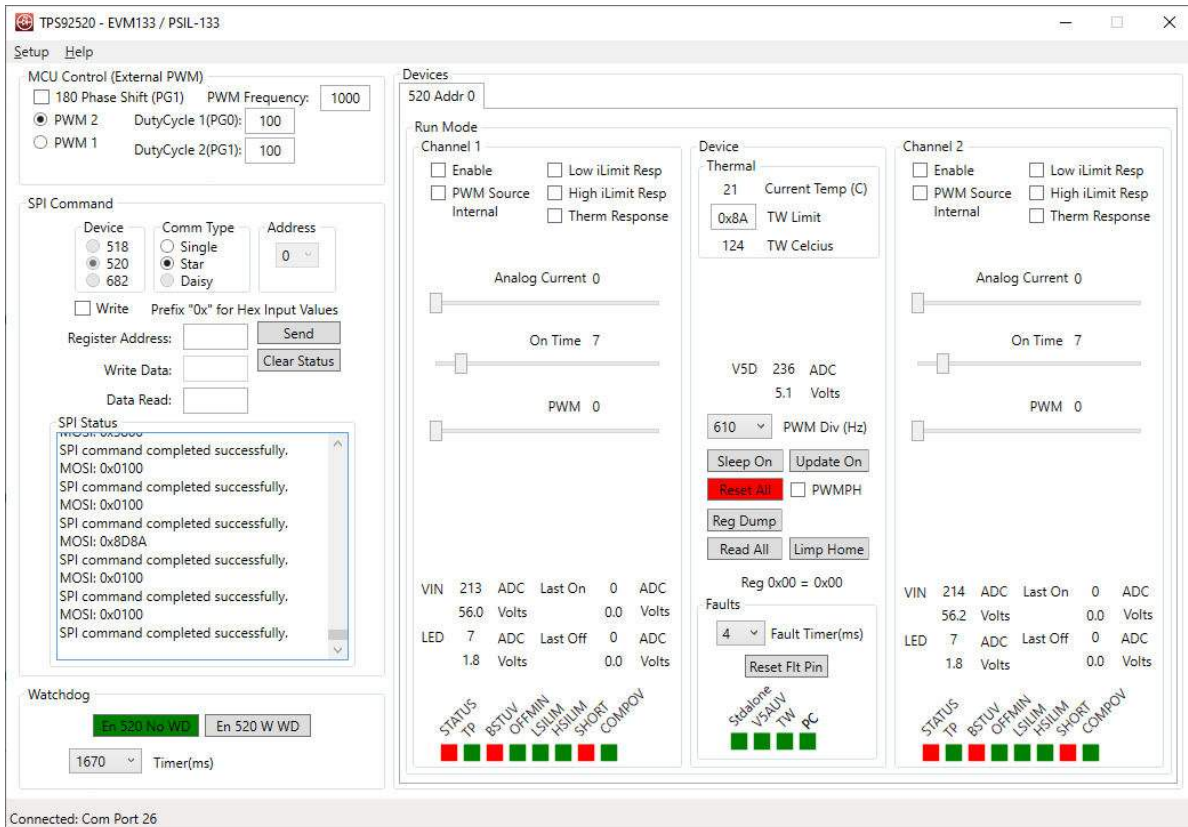
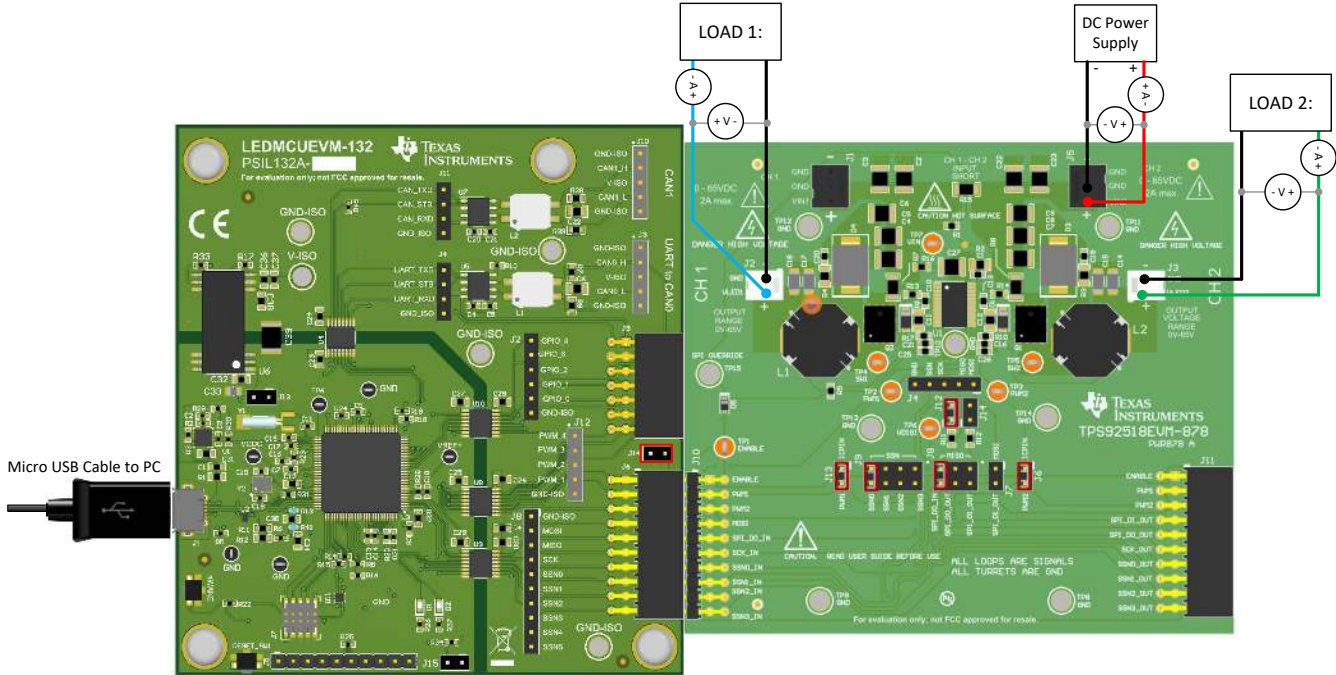


Figure 5-13. TPS92520EVM-133 Device Command Window

### 5.4.3 TPS92518EVM-878 Connections and Power Up

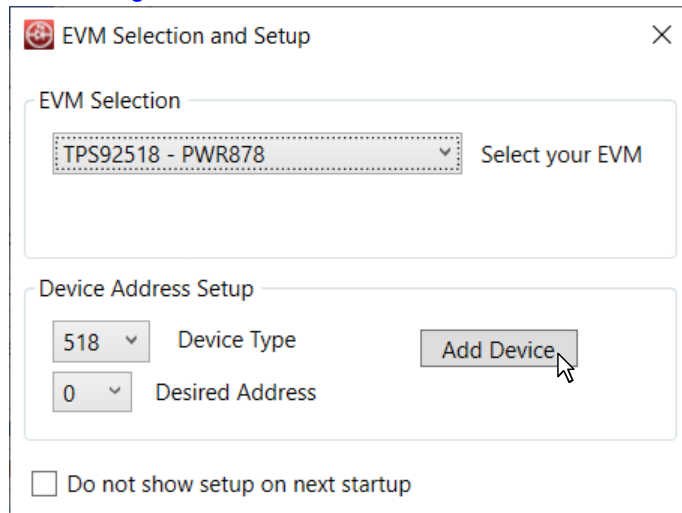
The TPS92518EVM-878 can be connected to the LEDMCUEVM-132 and use the associated GUI to monitor and control the TPS92518HV-Q1 device using the SPI bus to read and write commands. Here is a typical setup for controlling and testing the TPS92518EVM-878, see [Figure 5-14](#). Note jumper locations are in red.



**Figure 5-14. LEDMCUEVM-133 + TPS92518EVM-878 Connections and Setup**

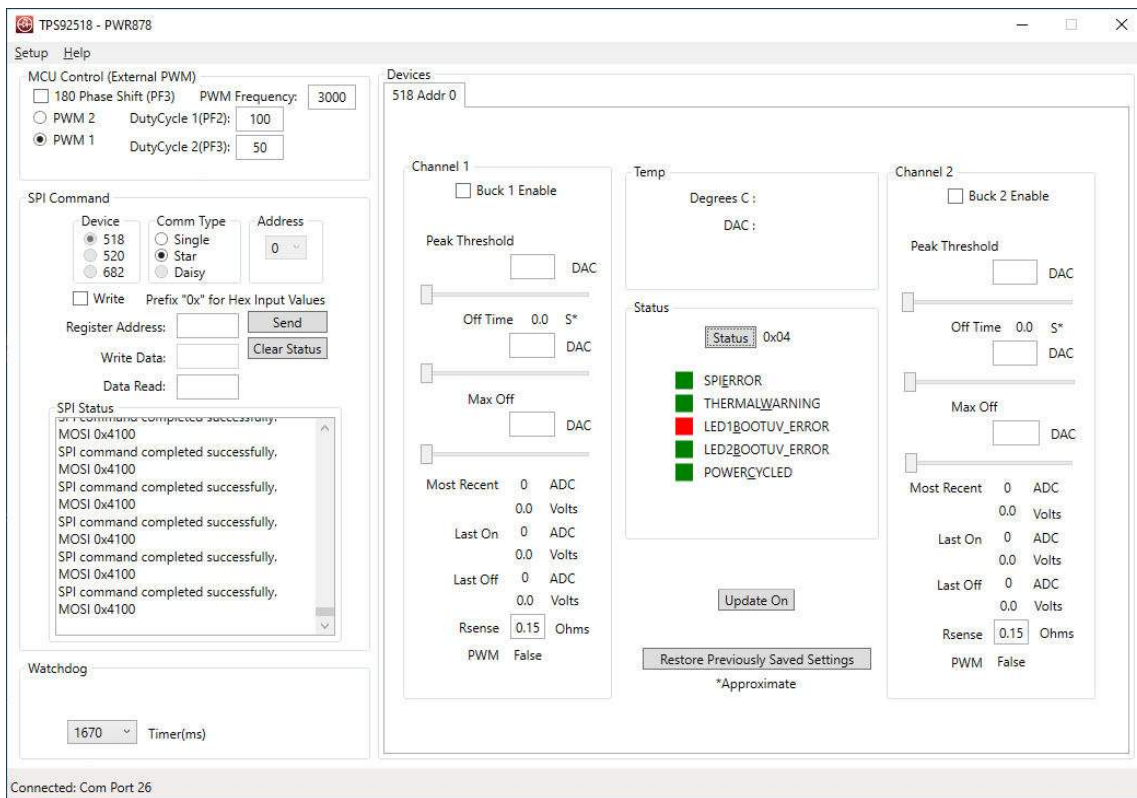
### 5.4.4 TPS92518EVM-878 Devices Window

When selecting the TPS92518EVM-878 from the **EVM Selection and Setup** window, simply select the **Add Device** button to start the GUI, see [Figure 5-15](#).



**Figure 5-15. TPS92518EVM-878 Menu From EVM Selection and Setup Window**

The Devices window of the TPS92518EVM-878 shows separate sub-windows that control each channel with features such as **Peak Threshold** control, **Off Time** control, ADC measurements, and many other selection boxes, and fault indication boxes. See the TPS92518EVM-878 user's guide for specifics on the operation of the GUI and how it controls the TPS92518HV-Q1 device.



**Figure 5-16. TPS92518EVM-878 Device Command Window**

### 5.4.5 TPS92682EVM-069 + TPS92520EVM-133 Connection and Power UP

The LEDMCUEVM-132 can be connected to the multiple EVMs to create more complicated LED systems. The TPS92682EVM-069 and the TPS92520EVM-133 can be connect together such that the TPS92682EVM-069 boost a lower input voltage, such a battery, and boost it to a higher voltage for use by the buck LED driver (TPS02520EVM-133). The LEDMCUEVM-132 and the GUI support these features by using the SPI bus. Here is a typical setup for controlling and testing the TPS92682EVM-069 with the TPS92520EVM-133. The loads are generally LEDs but can be a stacked diodes or power resistors depending on what testing is required. Use the "TPS92520, TPS92682 - LPP074 - E1" selection from **EVM Selection and Setup** screen to control this setup.

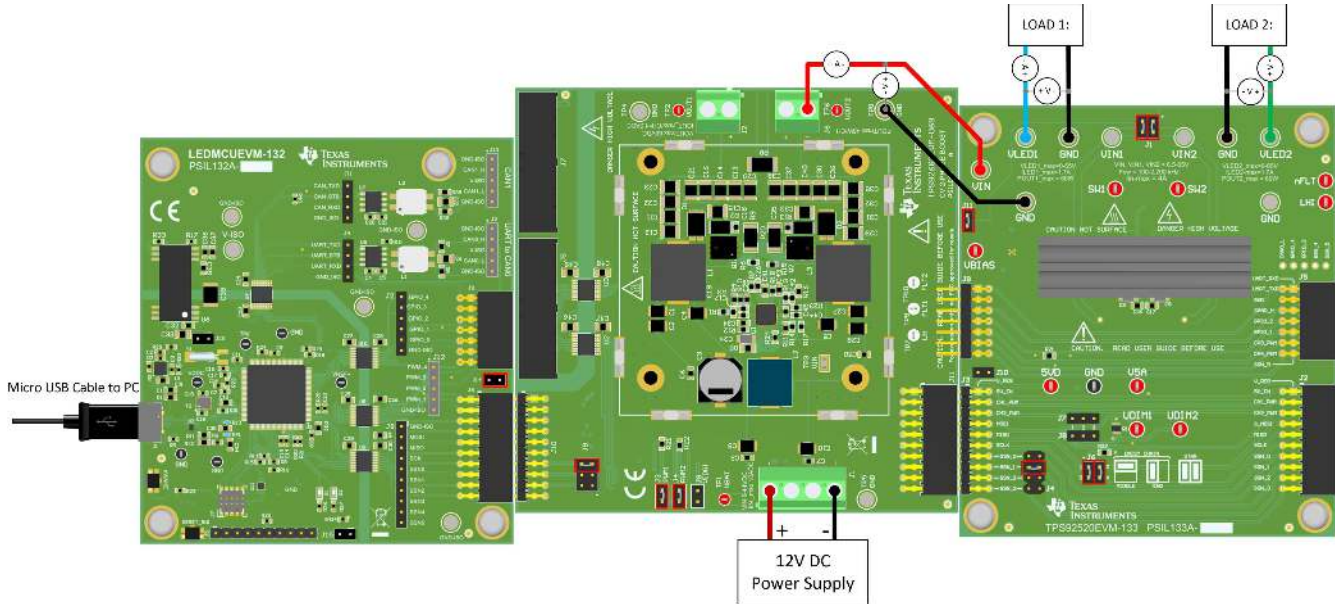


Figure 5-17. LEDMCUEVM-132 + TPS92682EVM-069 + TPS92520EVM-133 Connections and Setup

### 5.4.6 TPS92520, TPS92682 - LPP074 - E1 Devices Window

When selecting the "TPS92520, TPS92682 - LPP074 - E1" from the **EVM Selection and Setup** window, simply select the **Add Device** button to add the "682" at address 0 and change the selections to have the "520" at address 1 then select **Add Device** to add the second device, see FIG. This will start up after it has reached the number of devices you selected previously in the GUI, see [Figure 5-18](#).

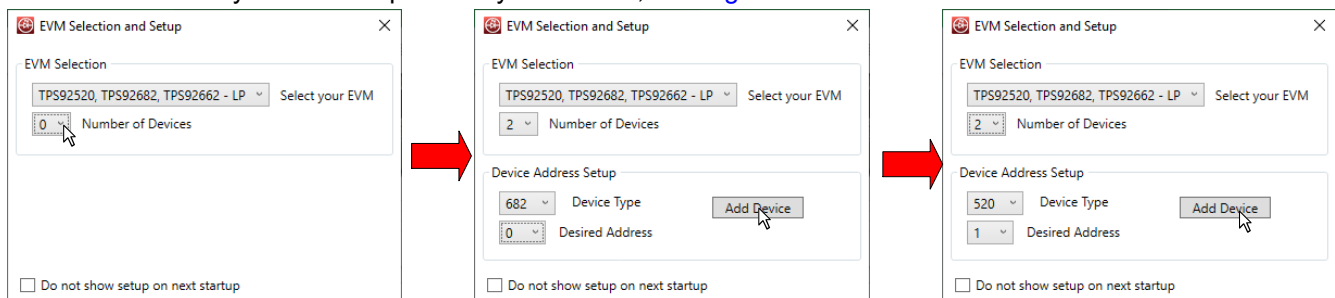
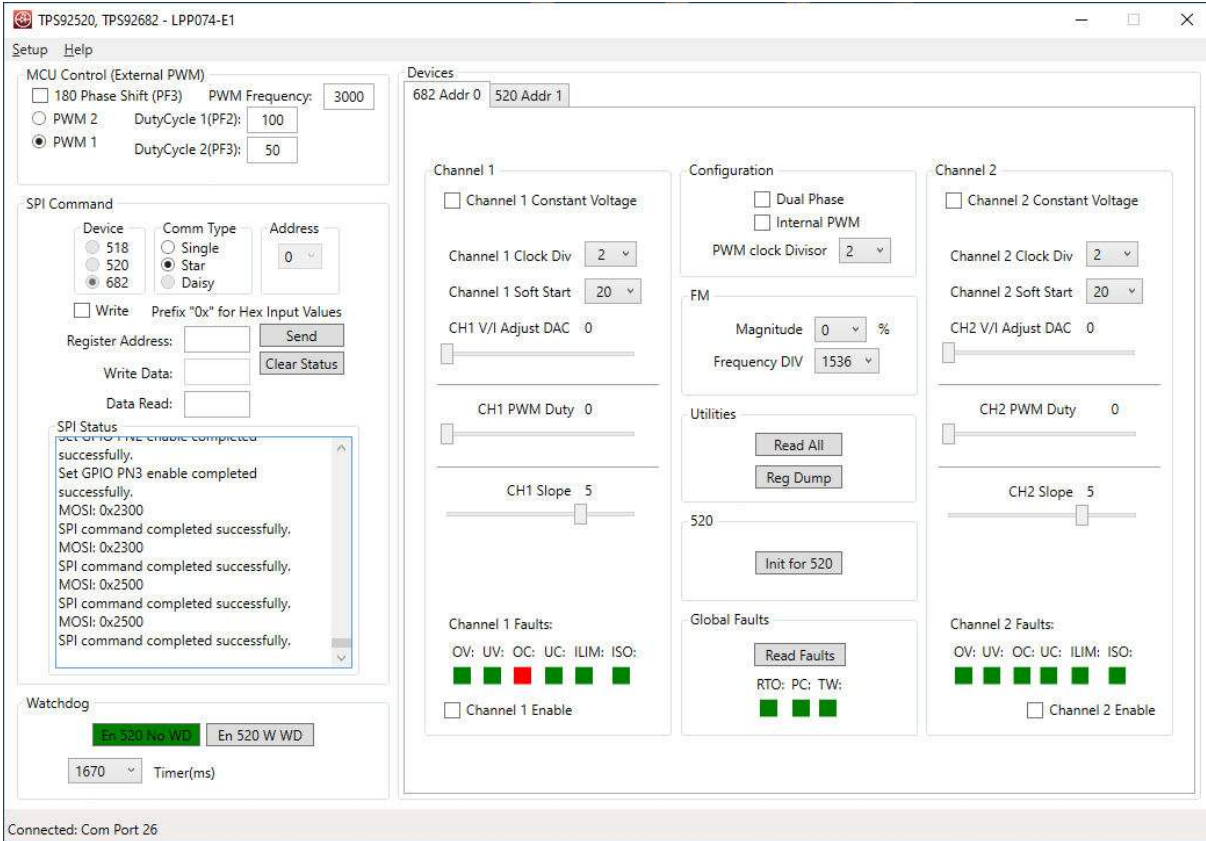


Figure 5-18. TPS92520, TPS92682 - LPP074 - E1 Menu From EVM Selection and Setup Window

The **Devices** window of the TPS92662EVM6-901 shows separate sub-windows that control each channel with features sure as **V/I Adjust** control, **Slope** control, PWM duty cycle control, selection boxes for "Constant



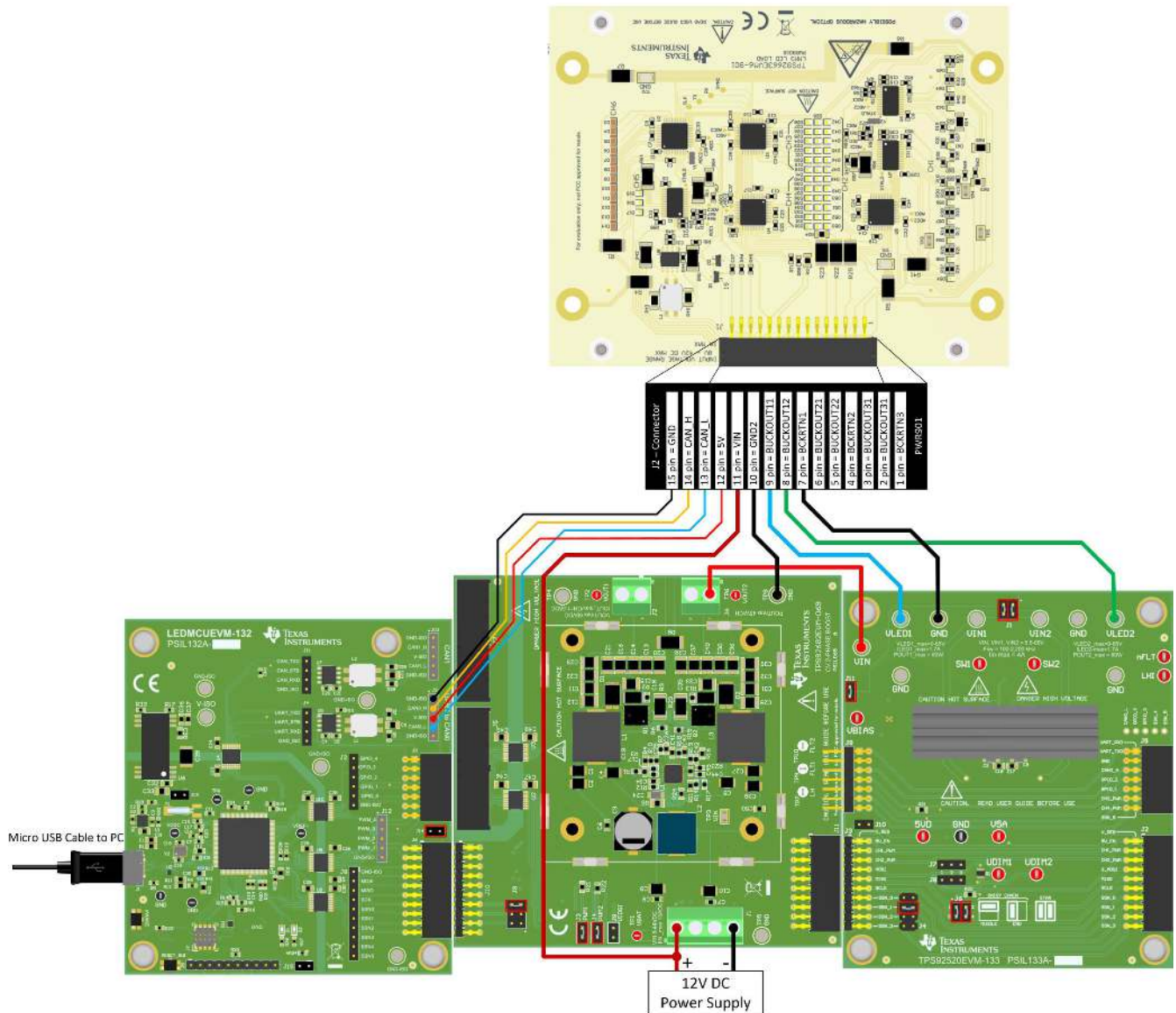
Voltage" and "Dual Phase", and fault indication boxes. See the TPS92682EVM-069 Users Guide for specifics on the operation of the GUI and how it controls the TPS92682-Q1 device.



**Figure 5-19. Devices Window for the "TPS92520, TPS92682 - LPP074 - E1" Selection From "EVM Selection and Setup" Screen**

### 5.4.7 TPS92682EVM-069 + TPS92520EVM-133 + TPS92662EVM6-901 Connection and Power UP

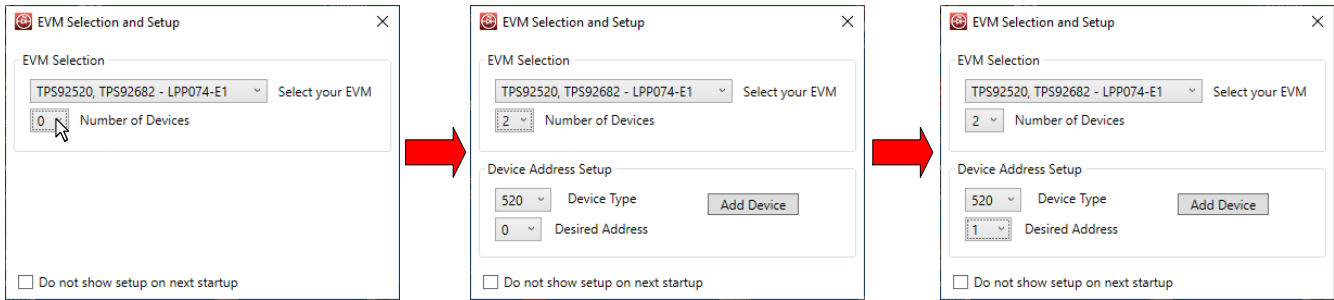
Another example is using TPS92682EVM-069, TPS92520EVM-133, and the TPS92662EVM6-901. The TPS92682EVM-069 and the TPS92520EVM-133 can be connected together such that the TPS92682EVM-069 boost a lower input voltage, such a battery, and boost it to a higher voltage for use by the buck LED driver (TPS02520EVM-133). The TPS92662EVM6-901 is a lighting matrix manager that has the ability to individually perform shunt FET dimming of the LEDs in the string. The LEDMCUEVM-132 and the GUI support these features by using the SPI bus and the UART over CAN hardware of the LEDMCUEVM-132. Here is a typical setup for controlling and testing the "TPS92520, TPS92682, TPS92662 - LPP074 - E2" selection from **EVM Selection and Setup** screen.



**Figure 5-20. LEDMCUEVM-132 + TPS92682EVM-069 + TPS92520EVM-133 + TPS92662EVM6-901 Connections and Setup**

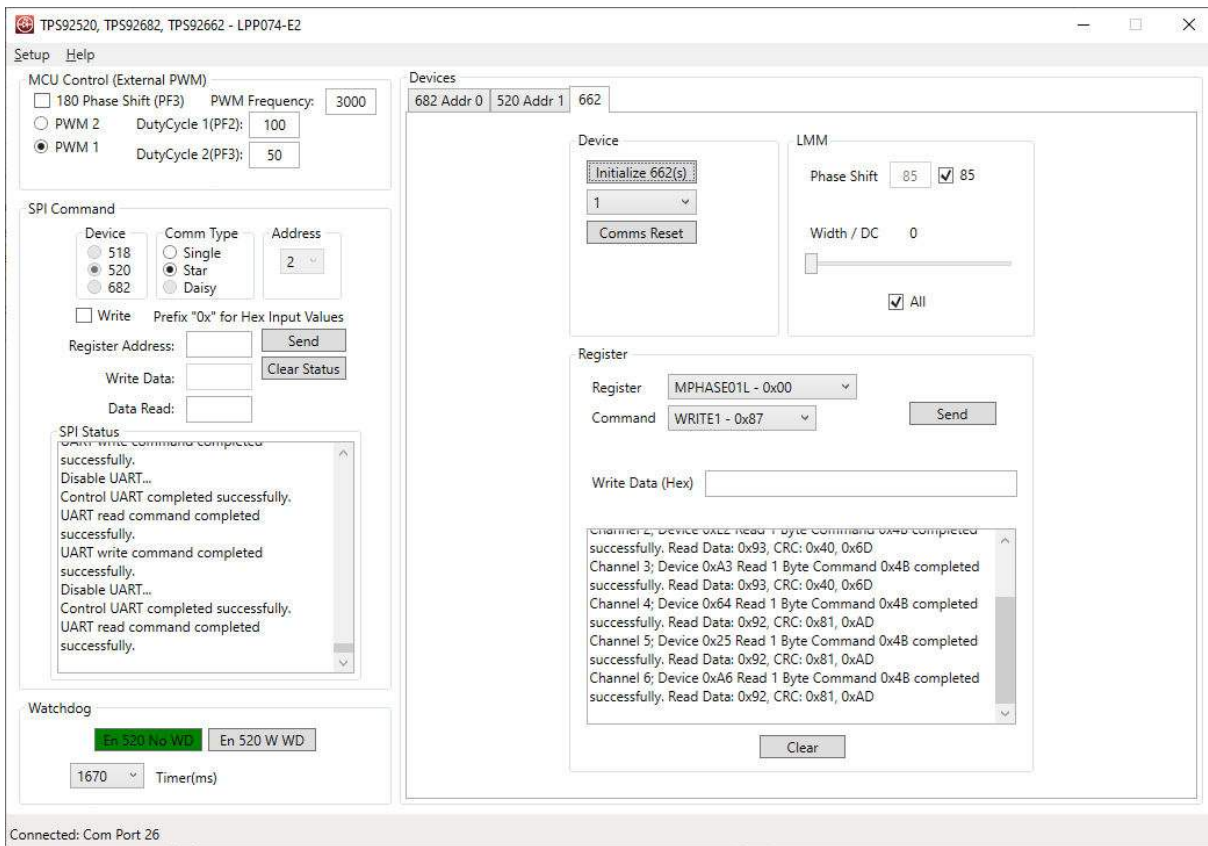
### 5.4.8 TPS92662EVM6-901 Devices Window

When selecting the "TPS92520, TPS92682, TPS92662 - LPP074 - E2" from the **EVM Selection and Setup** window, simply select two devices then select the **Add Device** button for both the 682 and 520 to start the GUI, see [Figure 5-21](#).



**Figure 5-21. "TPS92520, TPS92682, TPS92662 - LPP074 - E2" Menu From EVM Selection and Setup Window**

The **Devices** window of the TPS92662EVM6-901 shows separate sub-windows that control each channel with features such as **Phase Shift** control, **Width/DC** control, selection boxes for "ALL" channels and "85" phase shift. See the TPS92520EVM-074 Users Guide for specifics on the operation of the GUI and how it controls the TPS92662-Q1 device.



**Figure 5-22. Devices Window for the TPS92520, TPS92682, TPS92662 - LPP074 - E2 Selection From EVM Selection and Setup Screen**

## IMPORTANT NOTICE AND DISCLAIMER

TI PROVIDES TECHNICAL AND RELIABILITY DATA (INCLUDING DATA SHEETS), DESIGN RESOURCES (INCLUDING REFERENCE DESIGNS), APPLICATION OR OTHER DESIGN ADVICE, WEB TOOLS, SAFETY INFORMATION, AND OTHER RESOURCES "AS IS" AND WITH ALL FAULTS, AND DISCLAIMS ALL WARRANTIES, EXPRESS AND IMPLIED, INCLUDING WITHOUT LIMITATION ANY IMPLIED WARRANTIES OF MERCHANTABILITY, FITNESS FOR A PARTICULAR PURPOSE OR NON-INFRINGEMENT OF THIRD PARTY INTELLECTUAL PROPERTY RIGHTS.

These resources are intended for skilled developers designing with TI products. You are solely responsible for (1) selecting the appropriate TI products for your application, (2) designing, validating and testing your application, and (3) ensuring your application meets applicable standards, and any other safety, security, regulatory or other requirements.

These resources are subject to change without notice. TI grants you permission to use these resources only for development of an application that uses the TI products described in the resource. Other reproduction and display of these resources is prohibited. No license is granted to any other TI intellectual property right or to any third party intellectual property right. TI disclaims responsibility for, and you will fully indemnify TI and its representatives against, any claims, damages, costs, losses, and liabilities arising out of your use of these resources.

TI's products are provided subject to [TI's Terms of Sale](#) or other applicable terms available either on [ti.com](http://ti.com) or provided in conjunction with such TI products. TI's provision of these resources does not expand or otherwise alter TI's applicable warranties or warranty disclaimers for TI products.

TI objects to and rejects any additional or different terms you may have proposed.

Mailing Address: Texas Instruments, Post Office Box 655303, Dallas, Texas 75265  
Copyright © 2022, Texas Instruments Incorporated