

## Data Sheet

---

### Description

The Broadcom<sup>®</sup> 1W High Power White LED is a high performance energy efficient device that can handle high thermal and high driving current.

The package is compatible with reflow soldering process. To facilitate easy pick-and-place assembly, the LEDs are packed in tape and reel. Every reel is shipped in single intensity and color bin to provide close uniformity.

### Features

- Available in 2700K, 3000K, 3500K, 4000K, 5000K, 5700K, 6200K, and 6500K
- Small footprint and low profile
- Energy efficient
- Compatible with reflow soldering process
- High current operation
- Long operation life
- Wide viewing angle
- Silicone encapsulation
- MSL 3 products

### Applications

- Retail display lighting
- Under cabinet lighting
- Incandescent lamp replacement
- Indoor commercial and residential lighting
- Indoor decorative lighting

<b>CAUTION</b>	The LEDs are ESD sensitive. Observe appropriate precautions during handling and processing. Refer to Application Note AN-1142 for additional details.
----------------	---

**Figure 1 Package Dimensions**

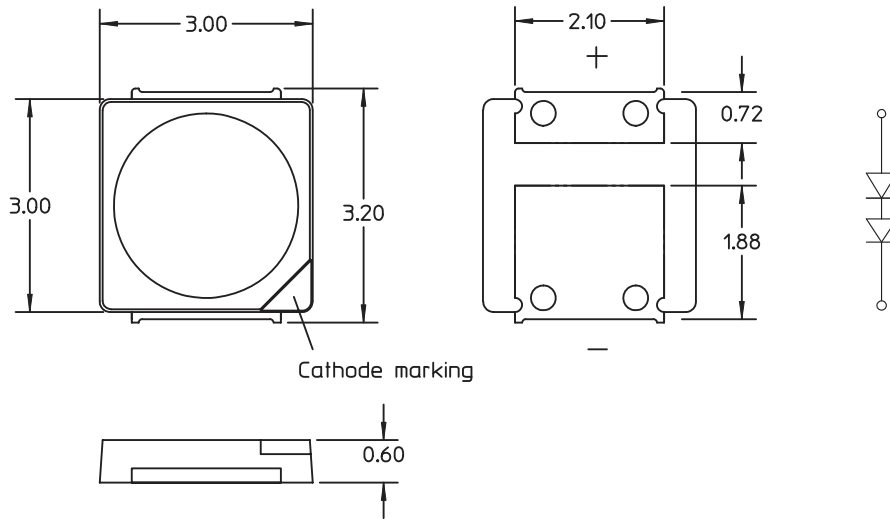

**NOTE**

1. All dimensions in millimeters (mm).
2. Tolerance is  $\pm 0.20$  mm unless otherwise specified.
3. Encapsulation = silicone.
4. Terminal finish = silver plating.

**Device Selection Guide ( $T_J = 25^\circ\text{C}$ ,  $I_F = 150\text{ mA}$ )**

Part Number	Color Temperature (K)	CRI	Luminous Flux, $\phi_V$ (lm) <sup>a, b</sup>			Luminous Efficiency (lm/W)
			Min	Typ	Max	
ASMF-PWG2-N45H0	6500	80	98.0	105	118.4	111
ASMF-PWG2-N45G0	6200	80	98.0	105	118.4	111
ASMF-PWG2-N45F0	5700	80	98.0	105	118.4	111
ASMF-PWG2-N45E0	5000	80	98.0	105	118.4	111
ASMF-PWG2-N45D0	4000	80	98.0	105	118.4	111
ASMF-PWG2-N35C0	3500	80	89.2	102	118.4	108
ASMF-PWG2-N35B0	3000	80	89.2	100	118.4	106
ASMF-PWG2-N35A0	2700	80	89.2	100	118.4	106

- a. Luminous flux is the total flux output as measured with an integrating sphere at a mono pulse condition.
- b. Luminous flux tolerance =  $\pm 12\%$ .

## Absolute Maximum Ratings

Parameter	Rating	Unit
DC Forward Current <sup>a</sup>	180	mA
Peak Forward Current <sup>b</sup>	540	mA
Power Dissipation	1260	mW
Reverse Voltage	Not recommended for reverse bias	
LED Junction Temperature	125	°C
Operating Temperature Range	-40 to +100	°C
Storage Temperature Range	-40 to +100	°C

- a. Derate linearly as shown in [Figure 12](#) and [Figure 13](#).  
 b. Duty Factor 10%, frequency 1 KHz.

## Optical and Electrical Characteristics (T<sub>J</sub> = 25°C)

Parameter	Symbol	Min	Typ	Max	Unit	Test Conditions
Viewing Angle <sup>a</sup>	2 θ <sub>1/2</sub>	—	120	—	Deg	I <sub>F</sub> = 150mA
Forward Voltage <sup>b</sup>	V <sub>F</sub>	6.0	6.3	7.0	V	I <sub>F</sub> = 150mA
Reverse Current <sup>c</sup>	I <sub>R</sub>	Not designed for reverse bias				
Thermal Resistance	R <sub>θJ-S</sub>	—	10	—	°C/W	LED junction to solder point

- a. 2θ<sub>1/2</sub> is the off axis angle where the luminous intensity is half of the peak intensity.  
 b. Forward voltage tolerance = ±0.1V.  
 c. Indicates product final test condition only. Long term reverse bias is not recommended.

## Part Numbering System

ASMF - PW x<sub>1</sub> 2 - N x<sub>2</sub> x<sub>3</sub> x<sub>4</sub> 0

Code	Description	Option	
x <sub>1</sub>	Color Rendering Index	G	CRI ≥ 80
x <sub>2</sub>	Minimum flux bin (lm)	3	89.2–98.0 lm
x <sub>3</sub>	Maximum flux bin (lm)	4	98.0–107.7 lm
		5	107.7–118.4 lm
x <sub>4</sub>	Color bin	A	2700K (bin: 27S)
		B	3000K (bin: 29S)
		C	3500K (bin: 34S)
		D	4000K (bin: 41S)
		E	5000K (bin: 50S)
		F	5700K (bin: 58G)
		G	6200K (bin: 62G)
		H	6500K (bin: 64S)

### Part Number Example

ASMF-PWG2-N35A0

x<sub>1</sub> = G → CRI ≥ 80

x<sub>2</sub> = 3 → Minimum flux bin 3

x<sub>3</sub> = 5 → Maximum flux bin 5

x<sub>4</sub> = A → Color bin 27S

## Bin Information

### Flux Bin Limit (CAT)

Bin	Luminous Flux (lm)	
	Min	Max
3	89.2	98.0
4	98.0	107.7
5	107.7	118.4

Tolerance =  $\pm 12\%$ .

### Forward Voltage Bin Limit (VF)

Bin	Forward Voltage (V)	
	Min	Max
F21	6.0	6.2
F22	6.2	6.4
F23	6.4	6.6
F24	6.6	6.8
F25	6.8	7.0

Tolerance =  $\pm 0.1V$ .

CAT: 3 — Flux bin 3  
 BIN: 27S — Color bin 27S  
 VF: F21 — VF bin F21

## Color Bin (BIN) Limits

CCT	Bin ID	Chromaticity Coordinates	
		x	y
2700	27S	0.4475	0.4012
		0.4582	0.4199
		0.4708	0.4228
		0.4598	0.4041
3000	29S	0.4295	0.3918
		0.4381	0.4097
		0.4515	0.4145
		0.4420	0.3962
3500	34S	0.4006	0.3811
		0.4061	0.3980
		0.4226	0.4056
		0.4150	0.3881
4000	41S	0.3699	0.3646
		0.3743	0.3846
		0.3885	0.3934
		0.3835	0.3741
5000	50S	0.3372	0.3449
		0.3378	0.3596
		0.3496	0.3694
		0.3478	0.3533
5700	58G	0.3220	0.3280
		0.3209	0.3425
		0.3330	0.3533
		0.3329	0.3375
6200	62G	0.3133	0.3214
		0.3113	0.3350
		0.3208	0.3444
		0.3219	0.3296
6500	64S	0.3079	0.3274
		0.3068	0.3354
		0.3181	0.3467
		0.3192	0.3387

Tolerance =  $\pm 0.01$ .

Figure 2 Chromaticity Diagram

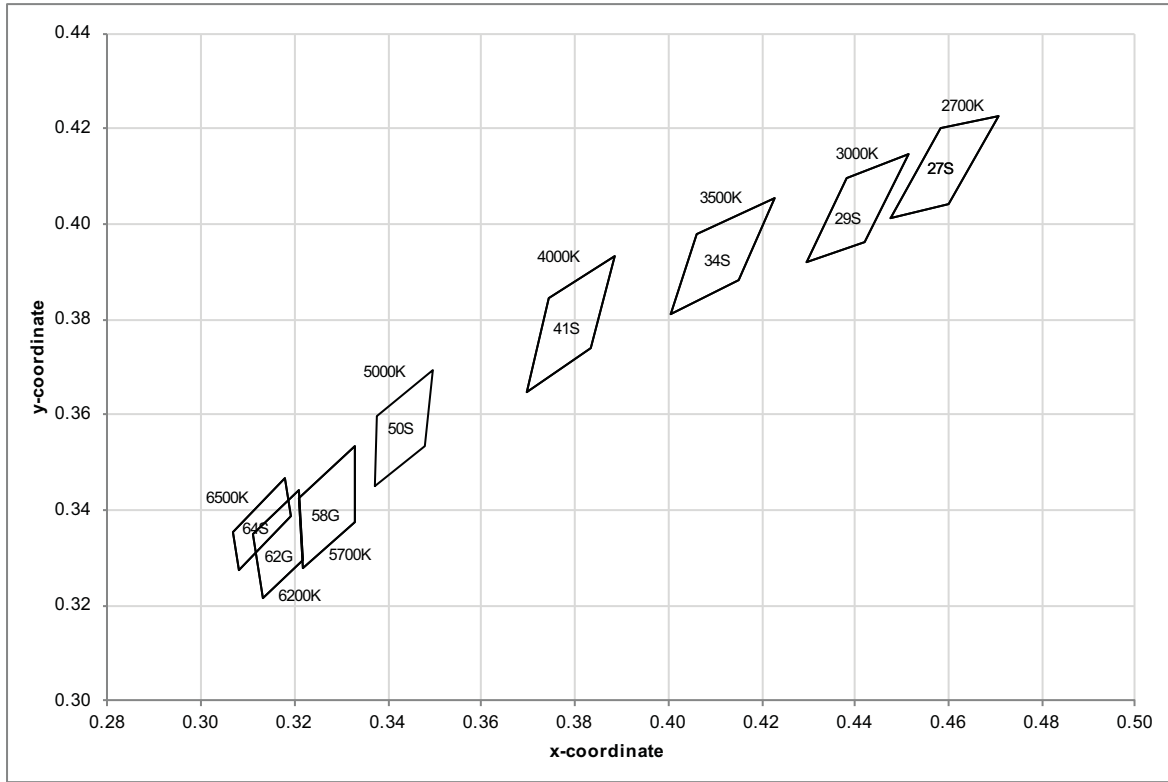

## Characteristics

**Figure 3 Relative Luminous Flux vs. Forward Current**

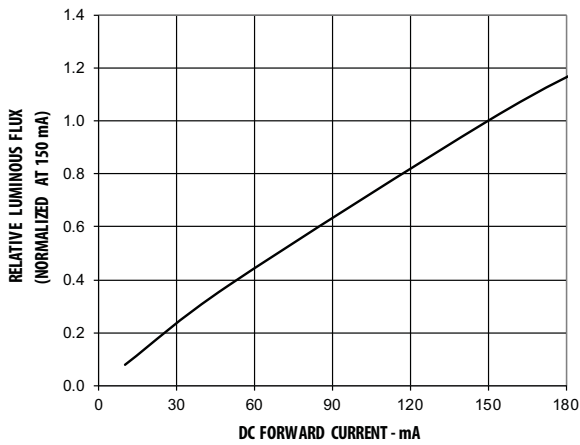

**Figure 4 Forward Current vs. Forward Voltage**

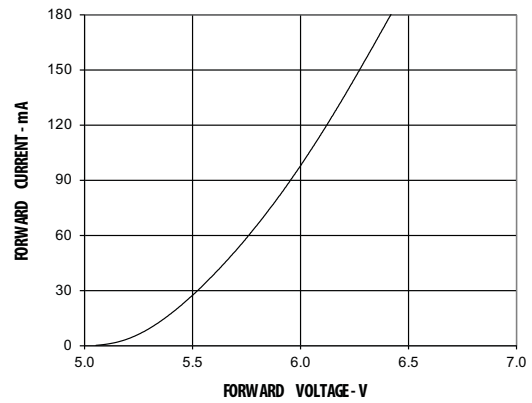

**Figure 5 Chromaticity Coordinate Shift vs. Forward Current for 6500K**

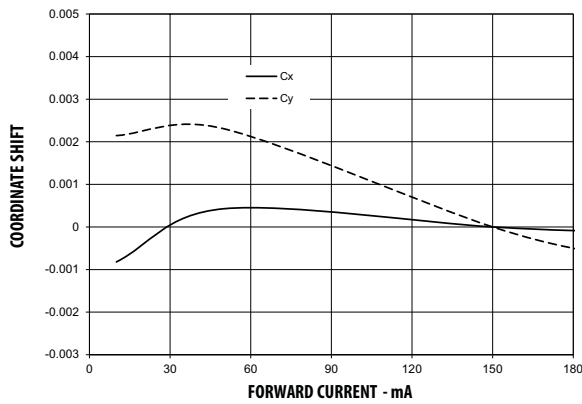

**Figure 6 Chromaticity Coordinate Shift vs. Forward Current for 2700K**

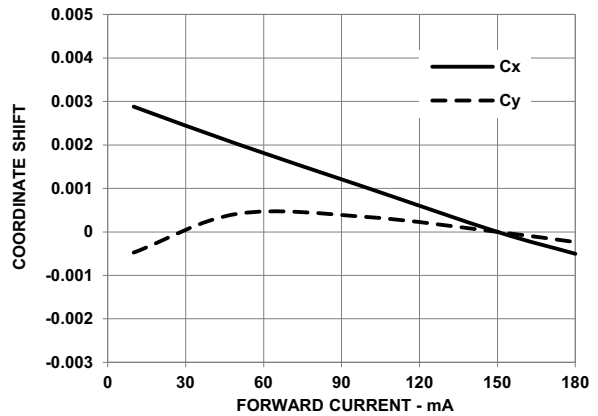

**Figure 7 Relative Light Output vs. Junction Temperature**

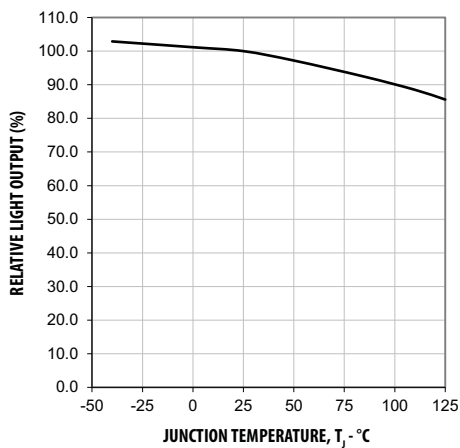

**Figure 8 Forward Voltage Shift vs. Junction Temperature**

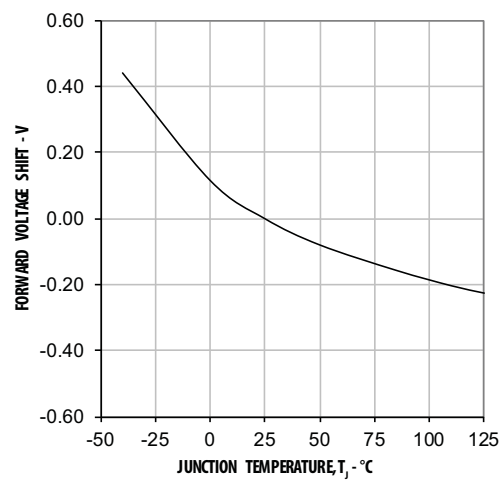

**Figure 9 Chromaticity Coordinate Shift vs. Junction Temperature for 6500K**

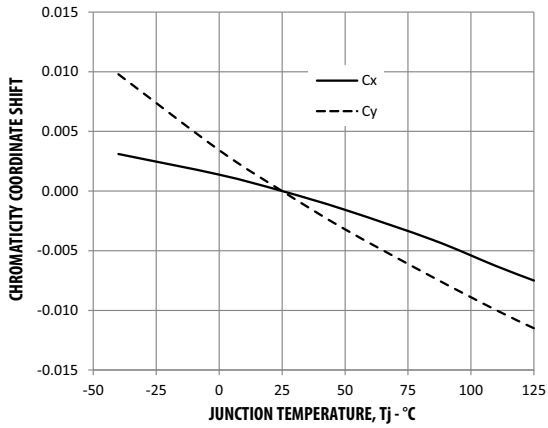

**Figure 10 Chromaticity Coordinate Shift vs. Junction Temperature for 2700K**

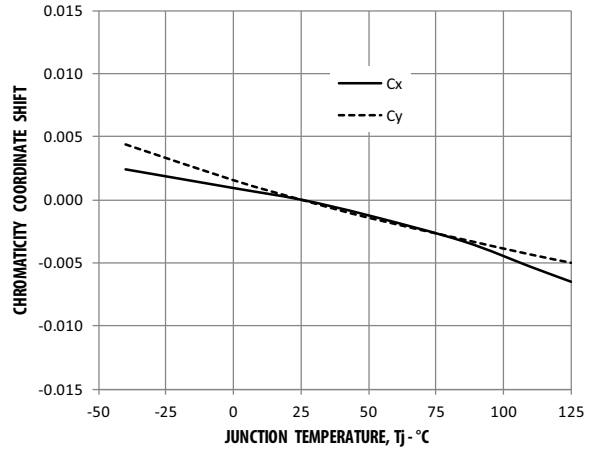

**Figure 11 Spectral Power Distribution**

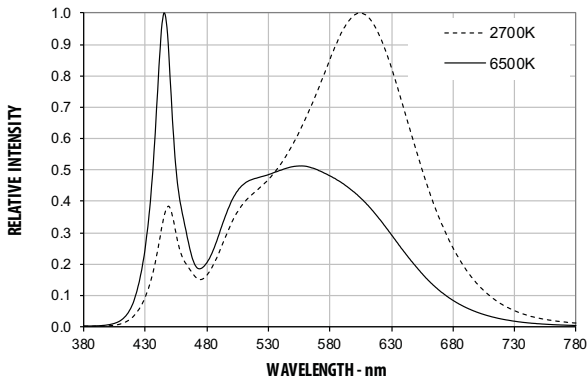

**Figure 12 Derating Curve According to Solder Point Temperature ( $T_s$ )**

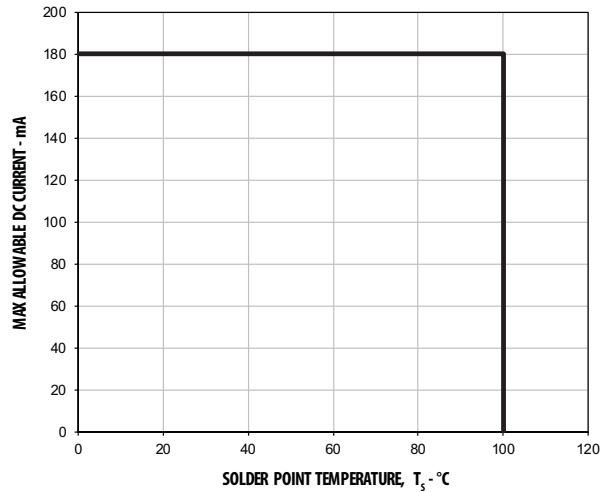

**Figure 13 Derating Curve According to Ambient Temperature ( $T_A$ )**

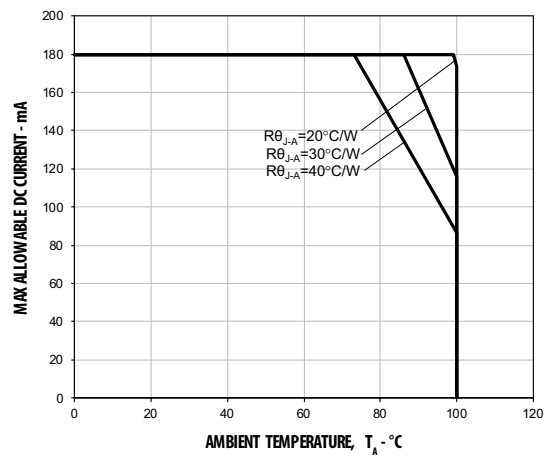



Figure 14 Pulse Handling Capability at  $T_C \leq 100^\circ\text{C}$

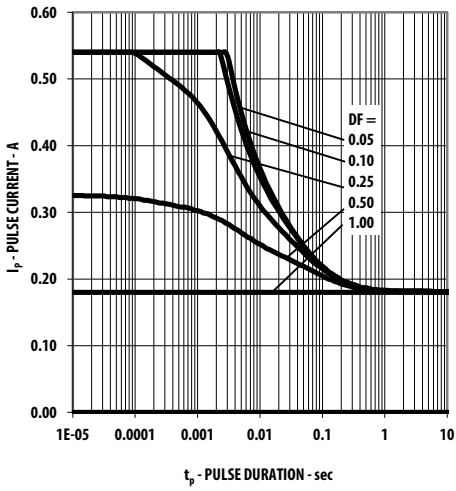
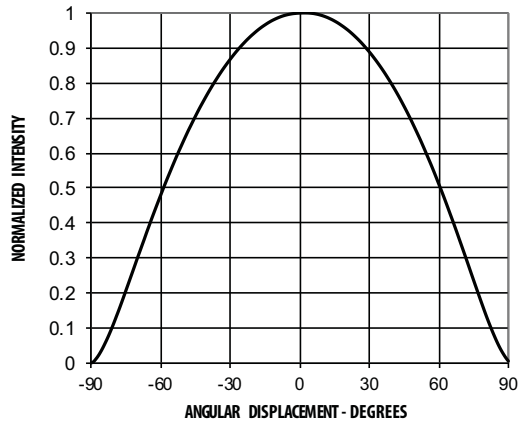
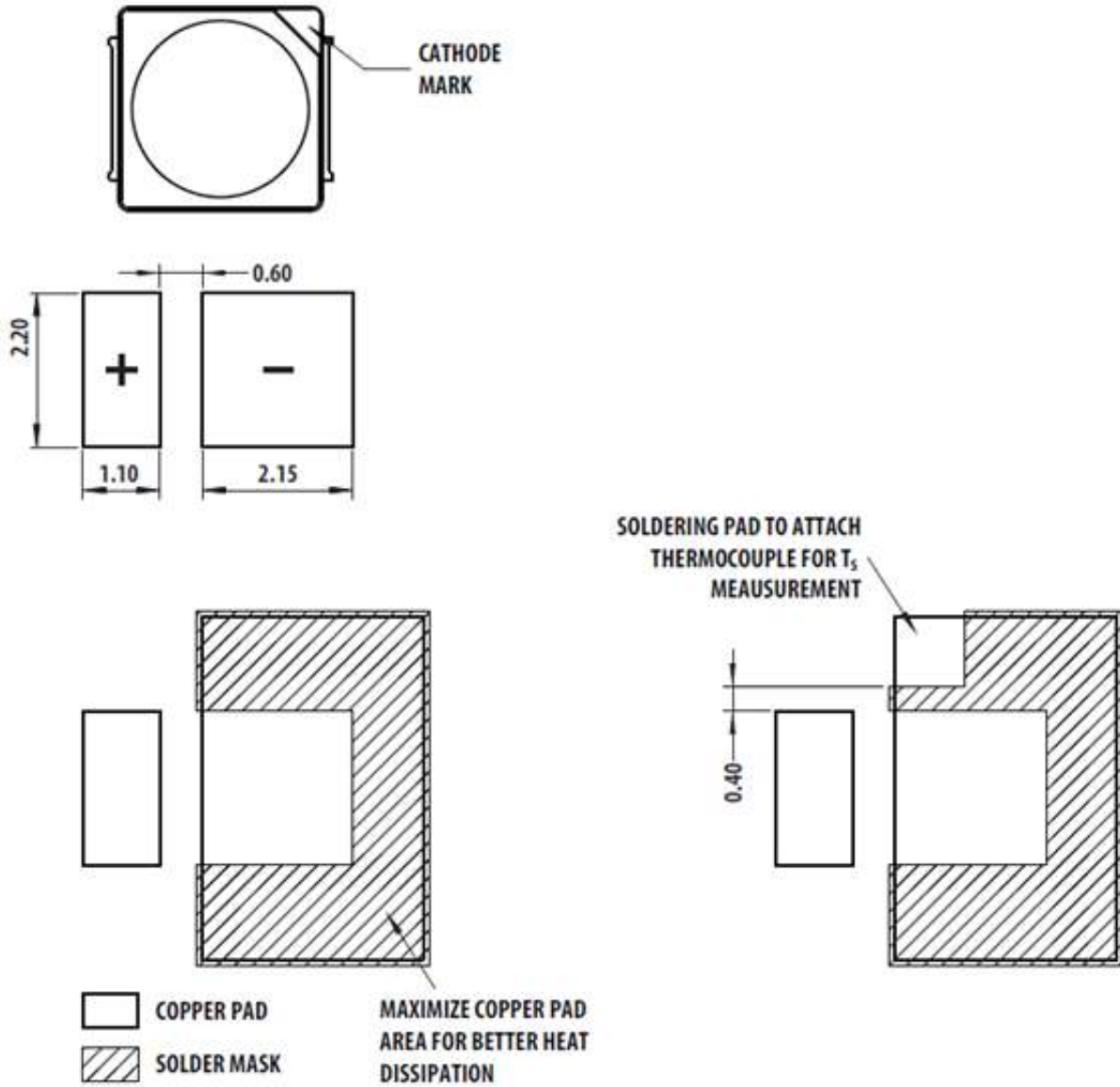

Figure 15 Radiation Pattern



## Soldering Land Pattern

Figure 16 Recommended Soldering Land Pattern (mm)



## Carrier Tape Dimensions

Figure 17 Carrier Tape Dimensions

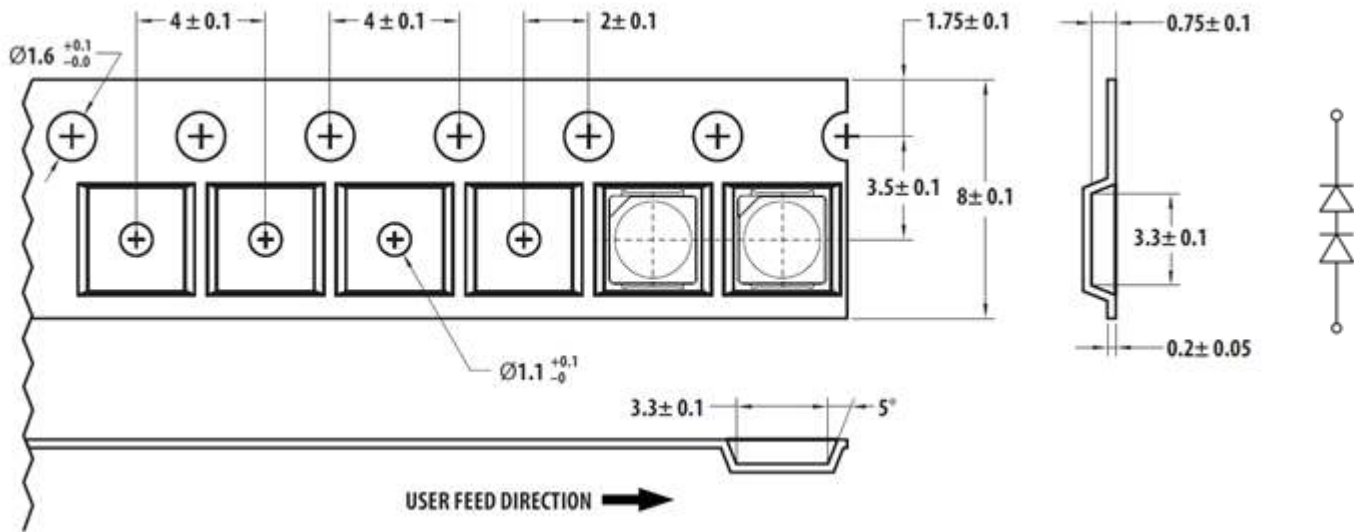
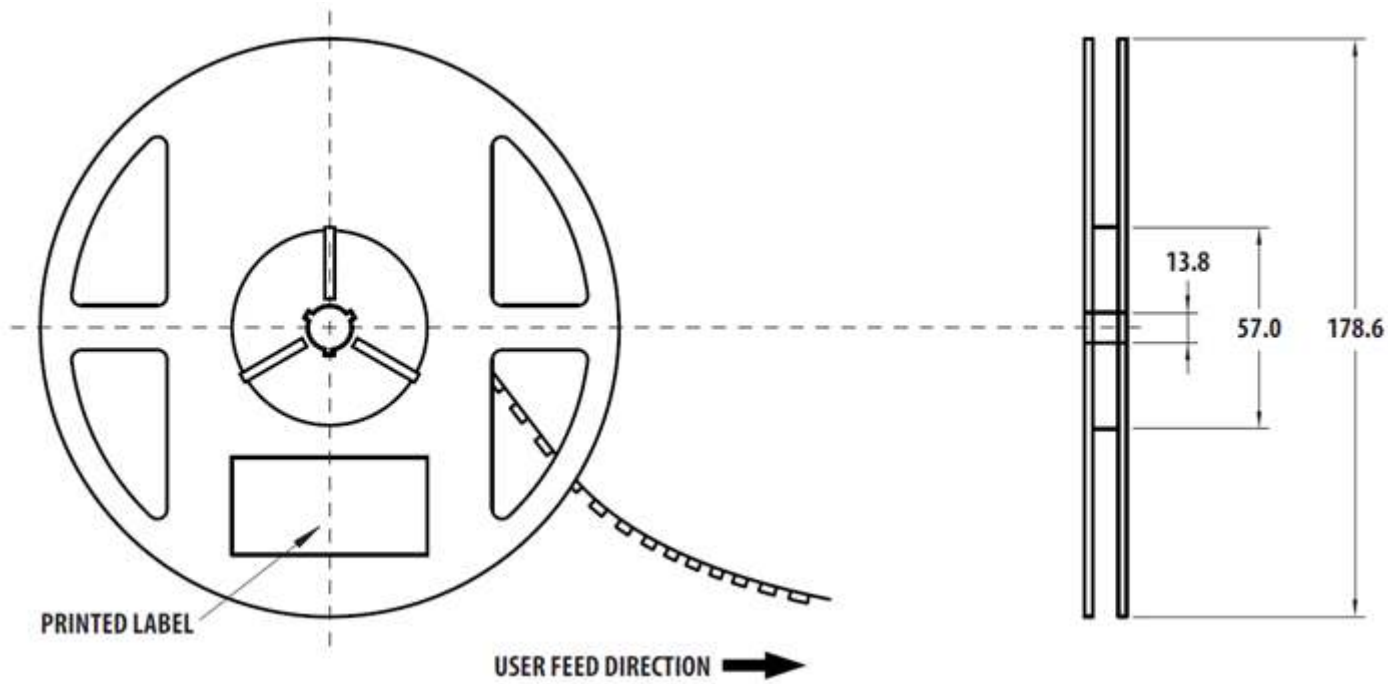

Figure 18 Reel Dimension



## Soldering

Recommended reflow soldering condition.

**Figure 19 Reflow Soldering**

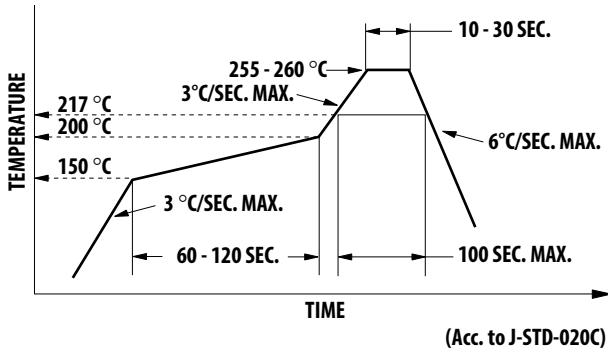

1. Do not perform reflow soldering more than twice.
2. Do not apply any pressure or force on the LED during reflow and after reflow while the LED is still hot.
3. Use reflow soldering to solder the LED. Use hand soldering only for rework if it is unavoidable; hand soldering is limited to the following conditions:
  - Soldering iron tip temperature = 315°C max
  - Soldering duration = 3 sec max
  - After hand soldering, the LED must be allowed to cool down prior to touch-up soldering.
4. Do not touch the LED body with the hot soldering iron except the soldering terminals because it might damage the LED.
5. Confirm beforehand whether the functionality and performance of the LED is affected by hand soldering.

## Precautionary Notes

### Handling Precautions

The encapsulation material of the LED is made of silicone for better product reliability. Compared to epoxy encapsulant that is hard and brittle, silicone is softer and flexible. Special handling precautions must be observed during assembly of silicone-encapsulated LED products. Failure to comply might lead to damage and premature failure of the LED. Refer to Application Note AN-5288, *Silicone Encapsulation for LED: Advantages and Handling Precautions* for more information.

1. Do not poke sharp objects into the silicone encapsulant. Sharp object, such as tweezers or syringes, might apply excessive force or even pierce through the silicone and cause failures to the LED die or wire bond.
2. Do not touch the silicone encapsulant. Uncontrolled force acting on the silicone encapsulant might result in excessive stress on the wire bond. Hold the LED only by the body.
3. Do not stack assembled PCBs together. Use an appropriate rack to hold the PCBs.
4. The surface of silicone material attracts dust and dirt easier than epoxy due to its surface tackiness. To remove foreign particles on the surface of silicone, use a cotton bud with isopropyl alcohol (IPA). During cleaning, rub the surface gently without putting much pressure on the silicone. Ultrasonic cleaning is not recommended.
5. For automated pick and place, Broadcom has tested the nozzle size shown in the following figure to working well with this LED. However, due to the possibility of variations in other parameters, such as pick-and-place, machine maker and model, and other settings of the machine, verify that the selected nozzle will damage the LED.

**Figure 20 Nozzle Size**

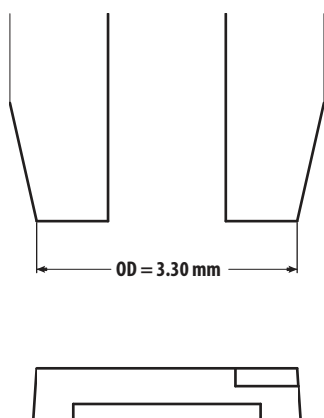

### Handling of Moisture Sensitive Devices

This product has a Moisture Sensitive Level 3 rating per JEDEC J-STD-020. Refer to Avago Application Note AN-5305, *Handling of Moisture Sensitive Surface Mount Devices*, for additional details and a review of proper handling procedures.

1. Before use:
  - An unopened moisture barrier bag (MBB) can be stored at  $< 40^{\circ}\text{C}/90\% \text{RH}$  for 12 months. If the actual shelf life has exceeded 12 months and the humidity indicator card (HIC) indicates that baking is not required, it is safe to reflow the LEDs per the original MSL rating.
  - Do not open the MBB prior to assembly (for example, for IQC).
2. Control after opening the MBB:
  - Read the HIC immediately upon opening the MBB.
  - Keep the LEDs at  $< 30^{\circ}\text{C}/60\% \text{RH}$  at all times. All high-temperature-related processes, including soldering, curing, or rework, must be completed within 168 hours.
3. Control for the unfinished reel:
 

Store unused LEDs in a sealed MBB with desiccant or desiccator at  $< 5\% \text{RH}$ .
4. Control of assembled boards:
 

If the PCB soldered with the LEDs is to be subjected to other high-temperature processes, store the PCB in a sealed MBB with desiccant or desiccator at  $< 5\% \text{RH}$  to ensure that all LEDs have not exceeded their floor life of 168 hours.
5. Baking is required if the following conditions exist:
  - The HIC indicator indicates a change in color for 10% and 5% as stated on the HIC.
  - The LEDs are exposed to conditions of  $> 30^{\circ}\text{C}/60\% \text{RH}$  at any time.
  - The LED floor life exceeded 168 hours.
  - The recommended baking condition is:  $60^{\circ}\text{C} \pm 5^{\circ}\text{C}$  for 20 hours.

Baking should only be done once.
6. Storage:
 

The soldering terminals of these Broadcom LEDs are silver plated. If the LEDs are exposed for too long in an ambient environment, the silver plating might oxidize; thus affecting its solderability performance. Therefore, keep unused LEDs in a sealed MBB with desiccant or in desiccator at  $< 5\% \text{RH}$ .

## Application Precautions

1. The drive current of the LED must not exceed the maximum allowable limit across temperature as stated in the data sheet. Constant current driving is recommended to ensure consistent performance.
2. The LED is not intended for reverse bias. Use other appropriate components for such purposes. When driving the LED in matrix form, make sure that the reverse bias voltage not exceed the allowable limit of the LED.
3. Do not use the LED in the vicinity of material with sulfur content or in environments with high gaseous sulfur compound and corrosive elements. Examples of material that might contain sulfur are rubber gaskets, room temperature vulcanizing (RTV) silicone rubber, rubber gloves, and so on. Prolonged exposure to such environments might affect the optical characteristics and product life.
4. Do not expose white LEDs to acidic environments and do not them in the vicinity of compounds that might have acidic outgas, such as, but not limited to, acrylate adhesive. These conditions will have adverse effect on the LED performance.
5. Avoid rapid changes in ambient temperature, especially in high-humidity environments, because this situation causes condensation on the LED.
6. If the LED is intended to be used in outdoor or harsh environments, protect the LED by means of a protective cover against damages caused by rain water, dust, oil, corrosive gases, external mechanical stress, and so on.

## Thermal Management

Optical, electrical, and reliability characteristics of LED are affected by temperature. Keep the junction temperature ( $T_J$ ) of the LED below the allowable limit at all times.  $T_J$  can be calculated as follows.

$$T_J = T_S + R_{\theta J-S} \times I_F \times V_{Fmax}$$

where  $T_S$  = LED solder point temperature as shown in illustration below ( $^{\circ}\text{C}$ )

$R_{\theta J-S}$  = Thermal resistance from junction to solder point ( $^{\circ}\text{C}/\text{W}$ )

$I_F$  = Forward current (A)

$V_{Fmax}$  = Maximum forward voltage (V)

**Figure 21 Thermal Management**

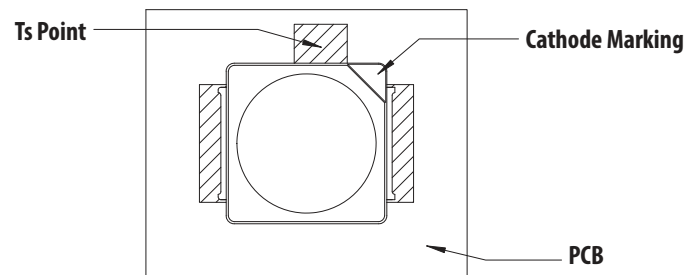

## Eye Safety Precautions

LEDs might pose optical hazards when in operation. Do not look directly at an operating LED because it might be harmful to the eyes. For safety reasons, use appropriate shielding or personal protective equipment.

## Disclaimer

Broadcom's products and software are not specifically designed, manufactured, or authorized for sale as parts, components, or assemblies for the planning, construction, maintenance, or direct operation of a nuclear facility or for use in medical devices or applications. The customer is solely responsible, and waives all rights to make claims against Broadcom or its suppliers, for all loss, damage, expense, or liability in connection with such use.

---

For product information and a complete list of distributors, please go to our web site:  
[www.broadcom.com](http://www.broadcom.com).

Broadcom, the pulse logo, Connecting everything, Avago Technologies, Avago, and the A logo are among the trademarks of Broadcom and/or its affiliates in the United States, certain other countries and/or the EU.

Copyright © 2016-2017 by Broadcom. All Rights Reserved.

The term "Broadcom" refers to Broadcom Limited and/or its subsidiaries. For more information, please visit [www.broadcom.com](http://www.broadcom.com).

Broadcom reserves the right to make changes without further notice to any products or data herein to improve reliability, function, or design.

Information furnished by Broadcom is believed to be accurate and reliable. However, Broadcom does not assume any liability arising out of the application or use of this information, nor the application or use of any product or circuit described herein, neither does it convey any license under its patent rights nor the rights of others.

ASMF-PWG2-DS102 – October 3, 2017

