

FQA90N10V2

100V N-Channel MOSFET

Features

- 105A, 100V, $R_{DS(on)} = 10m\Omega @ V_{GS} = 10V$
- Low gate charge (typical 147 nC)
- Low Crss (typical 300 pF)
- Fast switching
- 100% avalanche tested
- Improved dv/dt capability
- 175°C maximum junction temperature rating

Description

These N-Channel enhancement mode power field effect transistors are produced using Fairchild's proprietary, planar stripe, DMOS technology.

This advanced technology has been especially tailored to minimize on-state resistance, provide superior switching performance, and withstand high energy pulse in the avalanche and commutation mode. These devices are well suited for DC to DC converters, synchronous rectification, and other applications lowest $R_{ds(on)}$ is required.

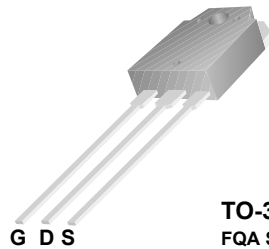

TO-3P
FQA Series

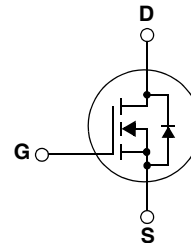

Absolute Maximum Ratings

Symbol	Parameter	FQA90N10V2	Unit
V_{DSS}	Drain-Source Voltage	100	V
I_D	Drain Current - Continuous ($T_C = 25^\circ C$) - Continuous ($T_C = 100^\circ C$)	105 78	A A
I_{DM}	Drain Current - Pulsed (Note 1)	420	A
V_{GSS}	Gate-Source voltage	± 30	V
E_{AS}	Single Pulsed Avalanche Energy (Note 2)	2430	mJ
I_{AR}	Avalanche Current (Note 1)	105	A
E_{AR}	Repetitive Avalanche Energy (Note 1)	33	mJ
dv/dt	Peak Diode Recovery dv/dt (Note 3)	4.5	V/ns
P_D	Power Dissipation ($T_C = 25^\circ C$) - Derate above 25°C	330 2.2	W W/°C
T_J, T_{STG}	Operating and Storage Temperature Range	-55 to +175	°C
T_L	Maximum Lead Temperature for Soldering Purpose, 1/8" from Case for 5 Seconds	300	°C

Thermal Characteristics

Symbol	Parameter	Min.	Max.	Unit
$R_{\theta JC}$	Thermal Resistance, Junction-to-Case	--	0.45	°C/W
$R_{\theta CS}$	Thermal Resistance, Case-to-Sink	0.24	--	°C/W
$R_{\theta JA}$	Thermal Resistance, Junction-to-Ambient	--	40	°C/W

Package Marking and Ordering Information

Device Marking	Device	Package	Reel Size	Tape Width	Quantity
AV290N10	FQA90N10V2	TO-3P	-	-	30

Electrical Characteristics T_C = 25°C unless otherwise noted

Symbol	Parameter	Conditions	Min.	Typ.	Max	Units
Off Characteristics						
BV _{DSS}	Drain-Source Breakdown Voltage	V _{GS} = 0V, I _D = 250μA	100	--	--	V
ΔBV _{DSS} / ΔT _J	Breakdown Voltage Temperature Coefficient	I _D = 250μA, Referenced to 25°C	--	0.1	--	V/°C
I _{DSS}	Zero Gate Voltage Drain Current	V _{DS} = 100V, V _{GS} = 0V V _{DS} = 80V, T _C = 150°C	--	--	1 10	μA μA
I _{GSSF}	Gate-Body Leakage Current, Forward	V _{GS} = 30V, V _{DS} = 0V	--	--	100	nA
I _{GSSR}	Gate-Body Leakage Current, Reverse	V _{GS} = -30V, V _{DS} = 0V	--	--	-100	nA
On Characteristics						
V _{GS(th)}	Gate Threshold Voltage	V _{DS} = V _{GS} , I _D = 250μA	2.0	--	4.0	V
R _{DS(on)}	Static Drain-Source On-Resistance	V _{GS} = 10V, I _D = 52.5A	--	8.5	10	mΩ
g _{FS}	Forward Transconductance	V _{DS} = 40V, I _D = 52.5A (Note 4)	--	72	--	S
Dynamic Characteristics						
C _{iss}	Input Capacitance	V _{DS} = 25V, V _{GS} = 0V, f = 1.0MHz	--	4730	6150	pF
C _{oss}	Output Capacitance		--	1180	1530	pF
C _{rss}	Reverse Transfer Capacitance		--	300	390	pF
Switching Characteristics						
t _{d(on)}	Turn-On Delay Time	V _{DD} = 100V, I _D = 90A R _G = 25Ω (Note 4, 5)	--	52	114	ns
t _r	Turn-On Rise Time		--	492	994	ns
t _{d(off)}	Turn-Off Delay Time		--	304	618	ns
t _f	Turn-Off Fall Time		--	355	720	ns
Q _g	Total Gate Charge	V _{DS} = 80V, I _D = 90A V _{GS} = 10V (Note 4, 5)	--	147	191	nC
Q _{gs}	Gate-Source Charge		--	28	--	nC
Q _{gd}	Gate-Drain Charge		--	60	--	nC
Drain-Source Diode Characteristics and Maximum Ratings						
I _S	Maximum Continuous Drain-Source Diode Forward Current		--	--	105	A
I _{SM}	Maximum Pulsed Drain-Source Diode Forward Current		--	--	420	A
V _{SD}	Drain-Source Diode Forward Voltage	V _{GS} = 0V, I _S = 105A	--	--	1.4	V
t _{rr}	Reverse Recovery Time	V _{GS} = 0V, I _S = 90A di _f /dt = 100A/μs (Note 4)	--	114	--	ns
Q _{rr}	Reverse Recovery Charge		--	0.54	--	μC

NOTES:

1. Repetitive Rating: Pulse width limited by maximum junction temperature
2. L = 0.22mH, I_{AS} = 105A, V_{DD} = 50V, R_G = 25Ω, Starting T_J = 25°C
3. I_{SD} ≤ 105A, di_f/dt ≤ 200A/μs, V_{DD} ≤ BV_{DSS}, Starting T_J = 25°C
4. Pulse Test: Pulse width ≤ 300μs, Duty Cycle ≤ 2%
5. Essentially Independent of Operating Temperature Typical Characteristics

Typical Performance Characteristics

Figure 1. On-Region Characteristics

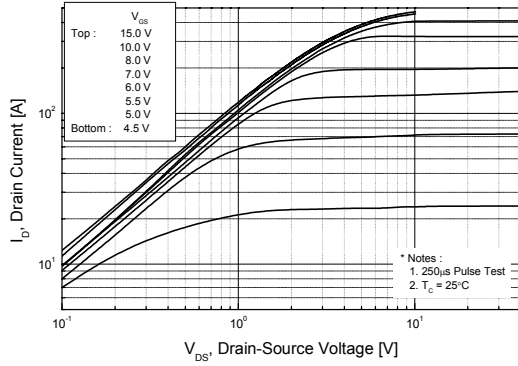

Figure 2. Transfer Characteristics

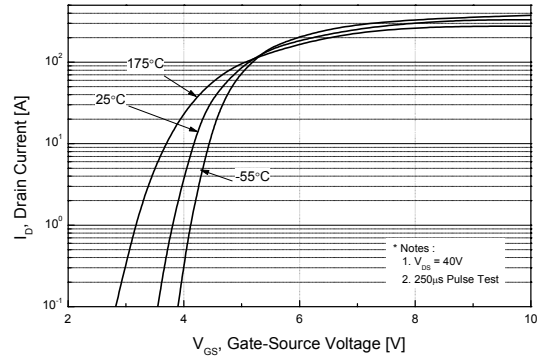

Figure 3. On-Resistance Variation vs. Drain Current and Gate Voltage

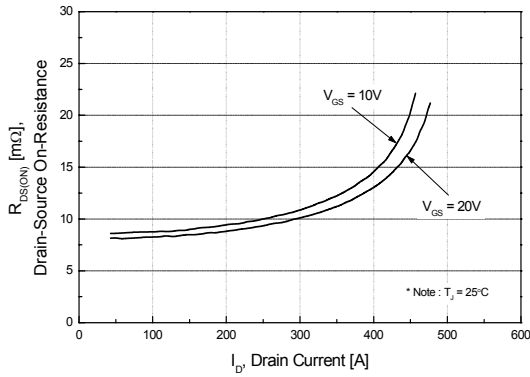

Figure 4. Body Diode Forward Voltage Variation vs. Source Current and Temperature

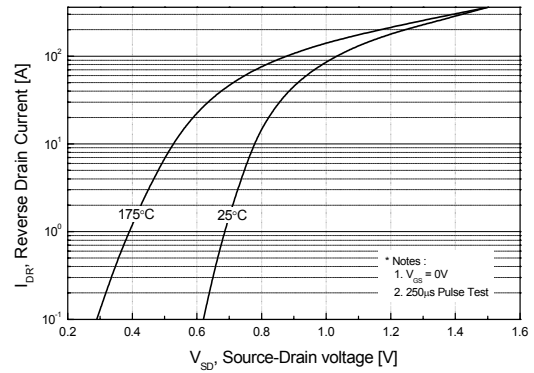

Figure 5. Capacitance Characteristics

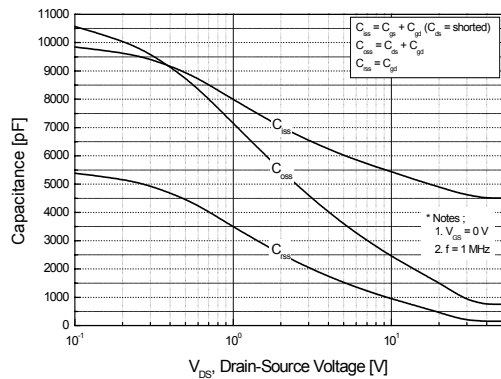
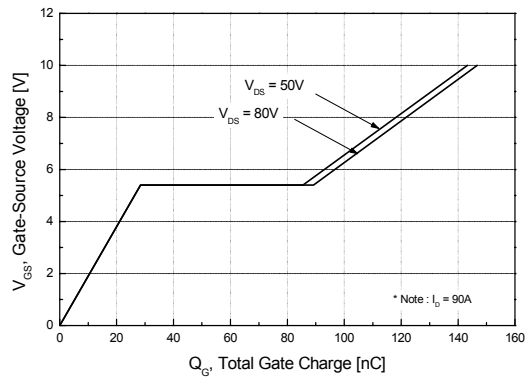

Figure 6. Gate Charge Characteristics



Typical Performance Characteristics (Continued)

Figure 7. Breakdown Voltage Variation vs. Temperature

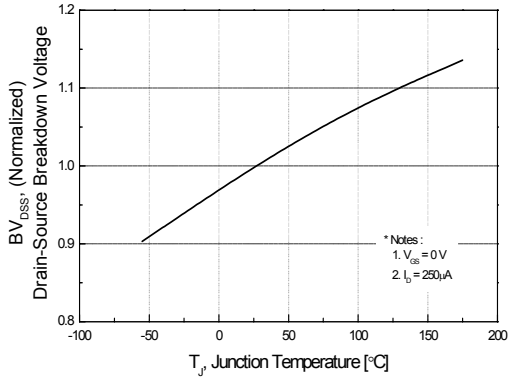

Figure 8. On-Resistance Variation vs. Temperature

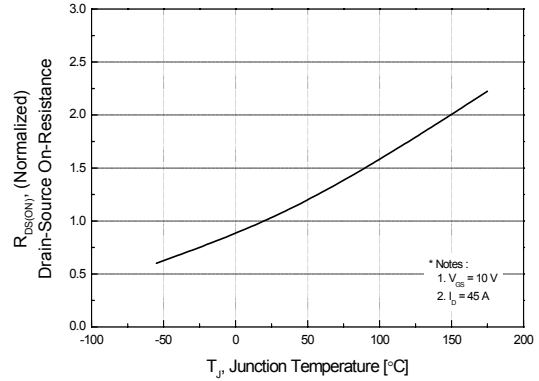

Figure 9. Maximum Safe Operating Area

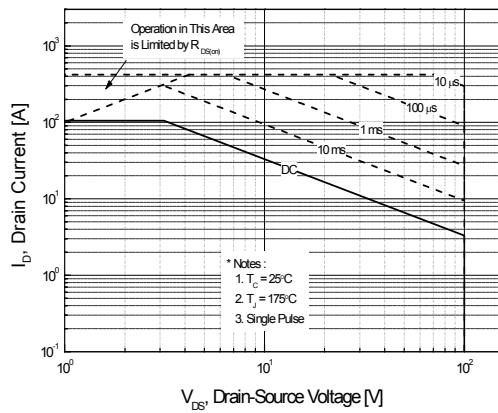

Figure 10. Maximum Drain Current vs. Case Temperature

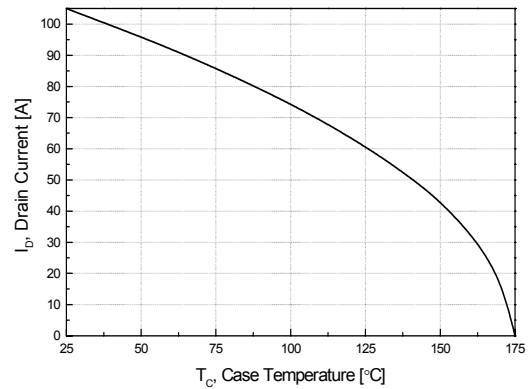
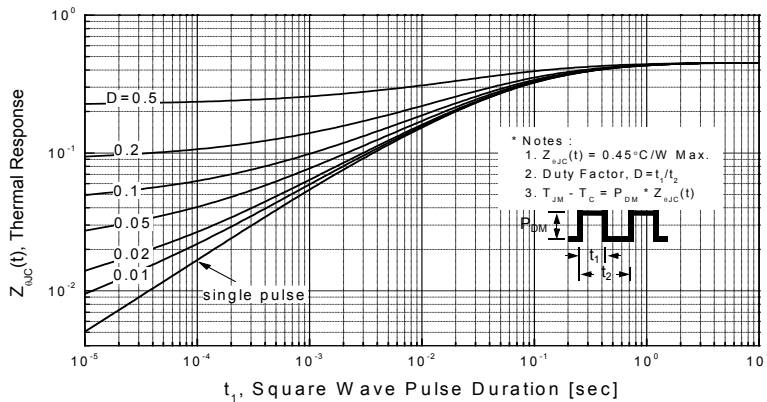
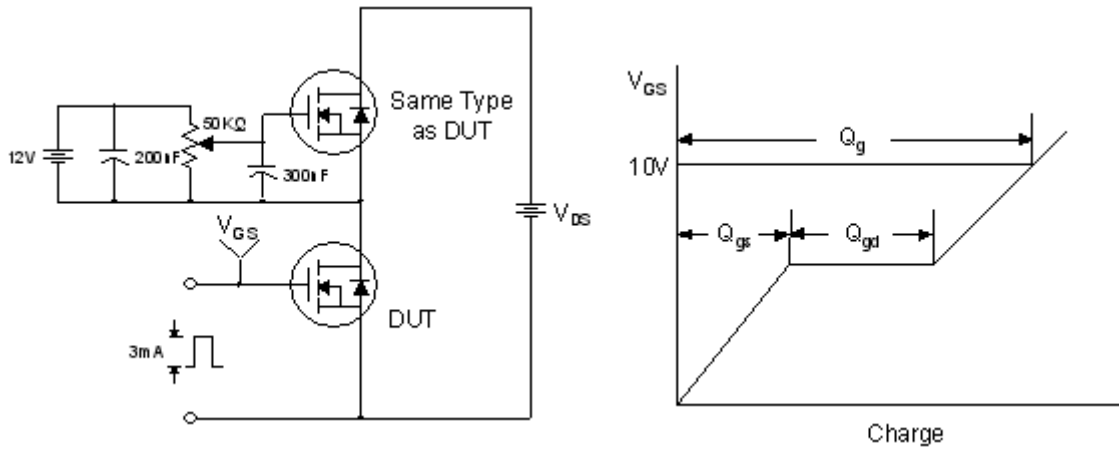

Figure 11. Transient Thermal Response Curve



Gate Charge Test Circuit & Waveform



Resistive Switching Test Circuit & Waveforms

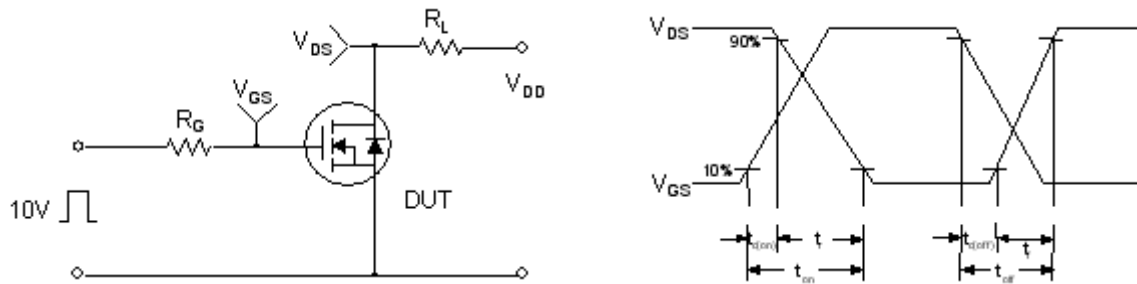

Unclamped Inductive Switching Test Circuit & Waveforms

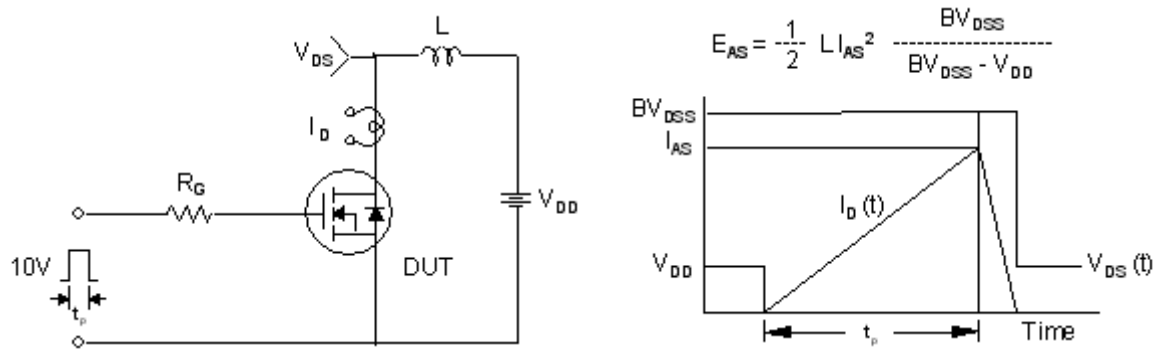

Peak Diode Recovery dv/dt Test Circuit & Waveforms



Mechanical Dimensions

TO-3P

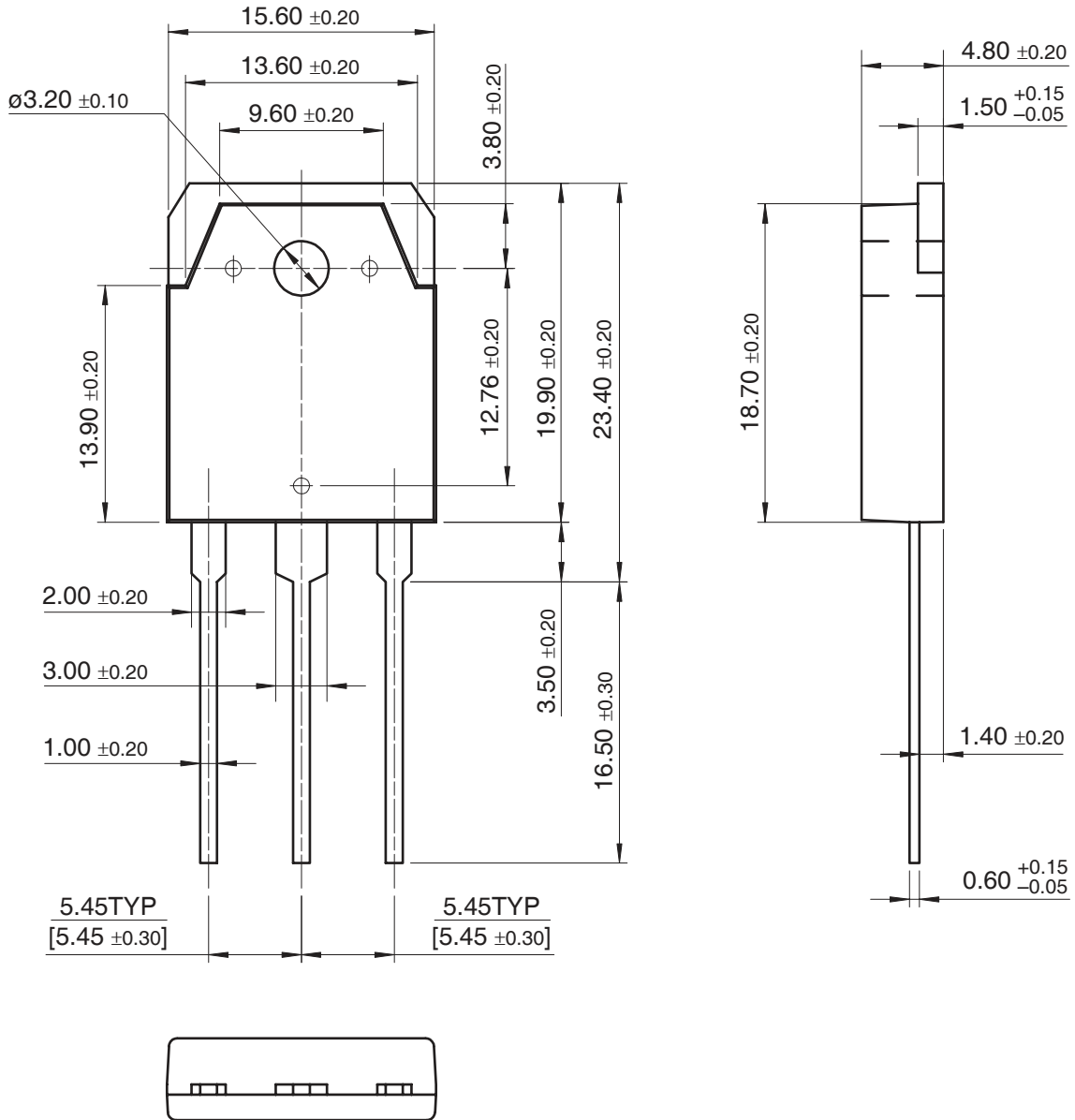

Dimensions in Millimeters

TRADEMARKS

The following are registered and unregistered trademarks Fairchild Semiconductor owns or is authorized to use and is not intended to be an exhaustive list of all such trademarks.

ACE _x [™]	FACT [™]	<i>i-Lo</i> [™]	PACMAN [™]	SPM [™]
ActiveArray [™]	FACT Quiet Series [™]	ImpliedDisconnect [™]	POP [™]	Stealth [™]
Bottomless [™]	FAST [®]	IntelliMAX [™]	Power247 [™]	SuperFET [™]
Build it Now [™]	FAST _r [™]	ISOPLANAR [™]	PowerEdge [™]	SuperSOT [™] -3
CoolFET [™]	FPS [™]	LittleFET [™]	PowerSaver [™]	SuperSOT [™] -6
CROSSVOL [™]	FRFET [™]	MICROCOUPLER [™]	PowerTrench [®]	SuperSOT [™] -8
DOME [™]	GlobalOptoisolator [™]	MicroFET [™]	QFET [®]	SyncFET [™]
EcoSPARK [™]	GTO [™]	MicroPak [™]	QS [™]	TinyLogic [®]
E ² CMOS [™]	HiSeC [™]	MICROWIRE [™]	QT Optoelectronics [™]	TINYOPTO [™]
EnSigna [™]	I ² C [™]	MSX [™]	Quiet Series [™]	TruTranslation [™]
		MSXPro [™]	RapidConfigure [™]	UHC [™]
Across the board. Around the world. [™]		OCX [™]	RapidConnect [™]	UltraFET [®]
The Power Franchise [®]		OCXPro [™]	μSerDes [™]	UniFET [™]
Programmable Active Droop [™]		OPTOLOGIC [®]	SILENT SWITCHER [®]	VCX [™]
		OPTOPLANAR [™]	SMART START [™]	Wire [™]

DISCLAIMER

FAIRCHILD SEMICONDUCTOR RESERVES THE RIGHT TO MAKE CHANGES WITHOUT FURTHER NOTICE TO ANY PRODUCTS HEREIN TO IMPROVE RELIABILITY, FUNCTION OR DESIGN. FAIRCHILD DOES NOT ASSUME ANY LIABILITY ARISING OUT OF THE APPLICATION OR USE OF ANY PRODUCT OR CIRCUIT DESCRIBED HEREIN; NEITHER DOES IT CONVEY ANY LICENSE UNDER ITS PATENT RIGHTS, NOR THE RIGHTS OF OTHERS.

LIFE SUPPORT POLICY

FAIRCHILD'S PRODUCTS ARE NOT AUTHORIZED FOR USE AS CRITICAL COMPONENTS IN LIFE SUPPORT DEVICES OR SYSTEMS WITHOUT THE EXPRESS WRITTEN APPROVAL OF FAIRCHILD SEMICONDUCTOR CORPORATION.

As used herein:

- Life support devices or systems are devices or systems which, (a) are intended for surgical implant into the body, or (b) support or sustain life, or (c) whose failure to perform when properly used in accordance with instructions for use provided in the labeling, can be reasonably expected to result in significant injury to the user.
- A critical component is any component of a life support device or system whose failure to perform can be reasonably expected to cause the failure of the life support device or system, or to affect its safety or effectiveness.

PRODUCT STATUS DEFINITIONS

Definition of Terms

Datasheet Identification	Product Status	Definition
Advance Information	Formative or In Design	This datasheet contains the design specifications for product development. Specifications may change in any manner without notice.
Preliminary	First Production	This datasheet contains preliminary data, and supplementary data will be published at a later date. Fairchild Semiconductor reserves the right to make changes at any time without notice in order to improve design.
No Identification Needed	Full Production	This datasheet contains final specifications. Fairchild Semiconductor reserves the right to make changes at any time without notice in order to improve design.
Obsolete	Not In Production	This datasheet contains specifications on a product that has been discontinued by Fairchild semiconductor. The datasheet is printed for reference information only.

Rev. 116