

SMA6SF5.0(C)A-Q1 THRU SMA6SF170(C)A-Q1

List

List..... 1

Package outline..... 2

Features..... 2

Mechanical data..... 2

Maximum ratings 2

Electrical characteristics..... 3~4

Rating and characteristic curves..... 5~6

Pinning information..... 7

Marking..... 7

Suggested solder pad layout..... 7

Packing information..... 8

Reel packing..... 9

Suggested thermal profiles for soldering processes..... 9

High reliability test capabilities..... 10

SMA6SF5.0(C)A-Q1 THRU SMA6SF170(C)A-Q1

600W Surface Mount Unidirectional and Bidirectional Transient Voltage Suppressors Diodes 5.0V-170V

Features

- Uni-directional and Bidirectional
- Stand-off voltage range: from 5.0V to 170V
- 600W peak pulse power capability with a 10/1000µs waveform, repetition rate (duty cycle): 0.01%
- Low profile surface mounted application in order to optimize board space
- Excellent clamping capability
- Low incremental surge resistance
- Fast response time from 0V to VBR, typically less than 1 ps for uni-directional
- Glass passivated chip junction
- Lead-free parts meet RoHS requirements
- Qualified to AEC-Q101 standards for high reliability
- Suffix "-H" indicates Halogen-free part, ex. SMA6SF5.0A-Q1-H

Mechanical data

- Epoxy:UL94-V0 rated flame retardant
- Case : Molded plastic, SMA-SF
- Terminals : Solder plated, solderable per MIL-STD-750, Method 2026
- Polarity : Color band denoted cathode except bidirectional
- Mounting Position : Any
- Weight : Approximated 0.04 gram

Package outline

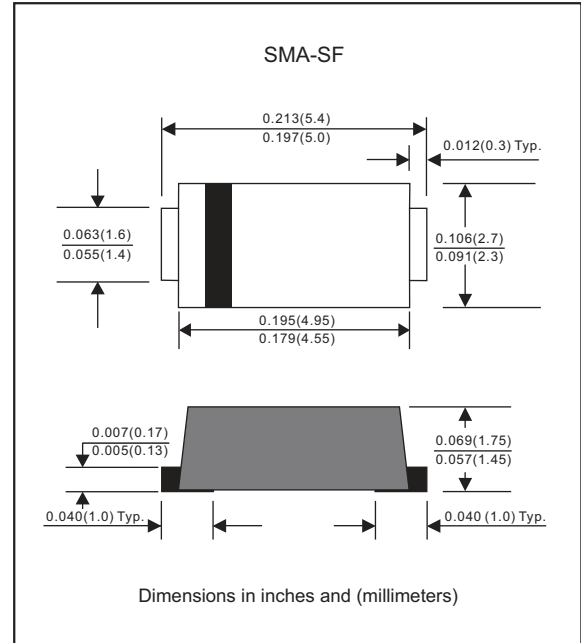

Maximum ratings (AT T_A=25°C unless otherwise noted)

Parameter	Conditions	Symbol	Value	Unit
Peak power dissipation	with a 10/1000µs waveform, Note 1, 2 & Fig. 1	P _{PPM}	600	W
Peak pulse current	with a 10/1000µs waveform	I _{PPM}	See Table 1	A
Steady state power dissipation	at T _L =75°C, Note 2	P _{M(AV)}	4.0	W
Peak forward surge current	8.3ms single half sine-wave, Note 3	I _{FSM}	60	A
Maximum instantaneous forward voltage	at I _F =25A For uni-directional types only, Note 4	V _F	3.5	V
Typical thermal resistance	Junction to case Junction to ambient	R _{θJC} R _{θJA}	33 55	°C/W
Operating junction temperature range		T _J	-55 to +150	°C
Storage temperature range		T _{STG}	-65 to +175	°C

Notes 1. Non-repetitive current pulse, per Fig. 3 and derated above T_A=25°C per Fig. 2
 2. Mounted on copper pad area of 0.2"x0.2" (5.0x5.0 mm) per Fig 5
 3. Measured on 8.3 ms single half sine-wave or equivalent square wave, duty cycle=4 pulses per minute maximum
 4. V_F<3.5V for V_{BR}<200V

Electrical characteristics (at $T_A=25^{\circ}\text{C}$ unless otherwise noted)

Part No. (Uni)	Part No. (Bi)	Reverse Stand-off Voltage	Breakdown Voltage @ I_T		Test Current	Maximum Clamping Voltage @ I_{PP}		Maximum Reverse Leakage Current	Marking Code	
		V_{RWM}	V_{BRMin}	V_{BRMax}	I_T	V_C	I_{PP}	$I_R@V_{RWM}$	Uni	Bi
		Volts	Volts	Volts	mA	Volts	A	μA		
SMA6SF5.0A-Q1	SMA6SF5.0CA-Q1	5.0	6.40	7.00	10	9.2	65.2	800	6AE	6WE
SMA6SF6.0A-Q1	SMA6SF6.0CA-Q1	6.0	6.67	7.37	10	10.3	58.2	800	6AG	6WG
SMA6SF6.5A-Q1	SMA6SF6.5CA-Q1	6.5	7.22	7.98	10	11.2	53.5	500	6AK	6WK
SMA6SF7.0A-Q1	SMA6SF7.0CA-Q1	7.0	7.78	8.60	10	12.0	50.0	200	6AM	6WM
SMA6SF7.5A-Q1	SMA6SF7.5CA-Q1	7.5	8.33	9.21	1.0	12.9	46.5	100	6AP	6WP
SMA6SF8.0A-Q1	SMA6SF8.0CA-Q1	8.0	8.89	9.83	1.0	13.6	44.1	50	6AR	6WR
SMA6SF8.5A-Q1	SMA6SF8.5CA-Q1	8.5	9.44	10.4	1.0	14.4	41.6	20	6AT	6WT
SMA6SF9.0A-Q1	SMA6SF9.0CA-Q1	9.0	10.0	11.1	1.0	15.4	38.9	10	6AV	6WV
SMA6SF10A-Q1	SMA6SF10CA-Q1	10	11.1	12.3	1.0	17.0	35.2	5	6AX	6WX
SMA6SF11A-Q1	SMA6SF11CA-Q1	11	12.2	13.5	1.0	18.2	32.9	5	6AZ	6WZ
SMA6SF12A-Q1	SMA6SF12CA-Q1	12	13.3	14.7	1.0	19.9	30.1	5	6BE	6XE
SMA6SF13A-Q1	SMA6SF13CA-Q1	13	14.4	15.9	1.0	21.5	27.9	5	6BG	6XG
SMA6SF14A-Q1	SMA6SF14CA-Q1	14	15.6	17.2	1.0	23.2	25.8	5	6BK	6XK
SMA6SF15A-Q1	SMA6SF15CA-Q1	15	16.7	18.5	1.0	24.4	24.5	5	6BM	6XM
SMA6SF16A-Q1	SMA6SF16CA-Q1	16	17.8	19.7	1.0	26.0	23.0	5	6BP	6XP
SMA6SF17A-Q1	SMA6SF17CA-Q1	17	18.9	20.9	1.0	27.6	21.7	5	6BR	6XR
SMA6SF18A-Q1	SMA6SF18CA-Q1	18	20.0	22.1	1.0	29.2	20.5	5	6BT	6XT
SMA6SF20A-Q1	SMA6SF20CA-Q1	20	22.2	24.5	1.0	32.4	18.5	5	6BV	6XV
SMA6SF22A-Q1	SMA6SF22CA-Q1	22	24.4	26.9	1.0	35.5	16.9	5	6BX	6XX
SMA6SF24A-Q1	SMA6SF24CA-Q1	24	26.7	29.5	1.0	38.9	15.4	5	6BZ	6XZ
SMA6SF26A-Q1	SMA6SF26CA-Q1	26	28.9	31.9	1.0	42.1	14.2	5	6CE	6YE
SMA6SF28A-Q1	SMA6SF28CA-Q1	28	31.1	34.4	1.0	45.4	13.2	5	6CG	6YG
SMA6SF30A-Q1	SMA6SF30CA-Q1	30	33.3	36.8	1.0	48.4	12.3	5	6CK	6YK
SMA6SF33A-Q1	SMA6SF33CA-Q1	33	36.7	40.6	1.0	53.3	11.2	5	6CM	6YM
SMA6SF36A-Q1	SMA6SF36CA-Q1	36	40.0	44.2	1.0	58.1	10.3	5	6CP	6YP
SMA6SF40A-Q1	SMA6SF40CA-Q1	40	44.4	49.1	1.0	64.5	9.3	5	6CR	6YR
SMA6SF43A-Q1	SMA6SF43CA-Q1	43	47.8	52.8	1.0	69.4	8.6	5	6CT	6YT
SMA6SF45A-Q1	SMA6SF45CA-Q1	45	50.0	55.3	1.0	72.7	8.2	5	6CV	6YV
SMA6SF48A-Q1	SMA6SF48CA-Q1	48	53.3	58.9	1.0	77.4	7.7	5	6CX	6YX
SMA6SF51A-Q1	SMA6SF51CA-Q1	51	56.7	62.7	1.0	82.4	7.2	5	6CZ	6YZ
SMA6SF54A-Q1	SMA6SF54CA-Q1	54	60.0	66.3	1.0	87.1	6.8	5	6RE	6ZE
SMA6SF58A-Q1	SMA6SF58CA-Q1	58	64.4	71.2	1.0	93.6	6.4	5	6RG	6ZG
SMA6SF60A-Q1	SMA6SF60CA-Q1	60	66.7	73.7	1.0	96.8	6.1	5	6RK	6ZK
SMA6SF64A-Q1	SMA6SF64CA-Q1	64	71.1	78.6	1.0	103.0	5.8	5	6RM	6ZM
SMA6SF70A-Q1	SMA6SF70CA-Q1	70	77.8	86.0	1.0	113.0	5.3	5	6RP	6ZP
SMA6SF75A-Q1	SMA6SF75CA-Q1	75	83.3	92.1	1.0	121.0	4.9	5	6RR	6ZR
SMA6SF78A-Q1	SMA6SF78CA-Q1	78	86.7	95.8	1.0	126.0	4.7	5	6RT	6ZT
SMA6SF85A-Q1	SMA6SF85CA-Q1	85	94.4	104	1.0	137.0	4.3	5	6RV	6ZV

Electrical characteristics (at $T_A=25^{\circ}\text{C}$ unless otherwise noted)

Part No. (Uni)	Part No. (Bi)	Reverse Stand-off Voltage	Breakdown Voltage @ I_T		Test Current	Maximum Clamping Voltage @ I_{PP}		Maximum Reverse Leakage Current	Marking Code	
		V_{RWM}	V_{BRMin}	V_{BRMax}	I_T	V_C	I_{PP}	$I_R@V_{RWM}$		
		Volts	Volts	Volts	mA	Volts	A	μA	Uni	Bi
SMA6SF90A-Q1	SMA6SF90CA-Q1	90	100	111	1.0	146.0	4.1	5	6RX	6ZX
SMA6SF100A-Q1	SMA6SF100CA-Q1	100	111	123	1.0	162.0	3.7	5	6RZ	6ZZ
SMA6SF110A-Q1	SMA6SF110CA-Q1	110	122	135	1.0	177.0	3.3	5	6SE	6VE
SMA6SF120A-Q1	SMA6SF120CA-Q1	120	133	147	1.0	193.0	3.1	5	6SG	6VG
SMA6SF130A-Q1	SMA6SF130CA-Q1	130	144	159	1.0	209.0	2.8	5	6SK	6VK
SMA6SF150A-Q1	SMA6SF150CA-Q1	150	167	185	1.0	243.0	2.4	5	6SM	6VM
SMA6SF160A-Q1	SMA6SF160CA-Q1	160	178	197	1.0	259.0	2.3	5	6SP	6VP
SMA6SF170A-Q1	SMA6SF170CA-Q1	170	189	209	1.0	275.0	2.1	5	6SR	6VR

- Notes 1. V_{BR} measured after I_T applied for 300 μs , I_T =square wave pulse or equivalent
 2. Surge current waveform per Fig. 3 and derated per Fig. 2
 3. For bi-directional types having V_{RWM} of 10 volts and less, the I_R limit is doubled
 4. Suffix 'C' denotes bi-directional devices. Suffix 'A' denotes 5% tolerance devices, no suffix denotes 10% tolerance devices
 5. All terms and symbols are consistent with ANS/IEEE C62.35
 6. Transient Voltage Suppressors (TVS) are devices used to protect vulnerable circuits from electrical overstress such as that caused by electrostatic discharge, inductive load switching and induced lightning. Within the TVS, damaging voltage spikes are limited by clamping or avalanche action of a rugged silicon pn junction which reduces the amplitude of the transient to a nondestructive level. See Fig. 7 & Fig. 8

Rating and characteristic curves (SMA6SF-Q1 SERIES)

Fig.1 - Peak Pulse Power Rating Curve

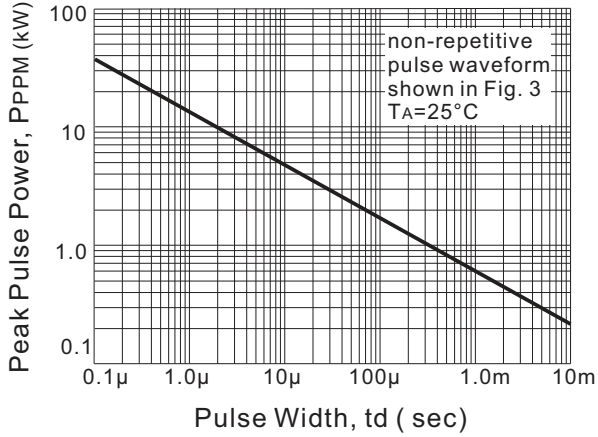

Fig.2 - Pulse Derating Curve

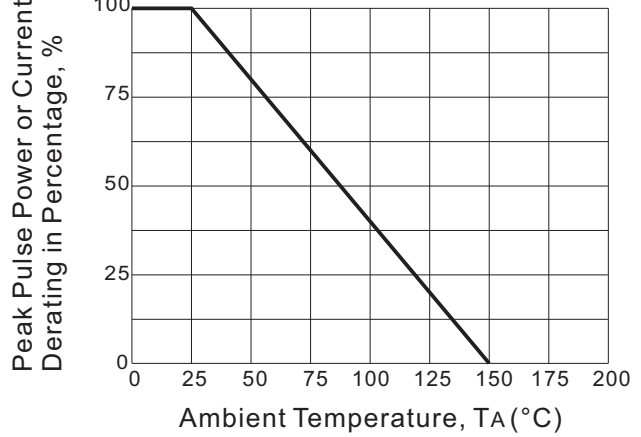

Fig.3 - Pulse Waveform

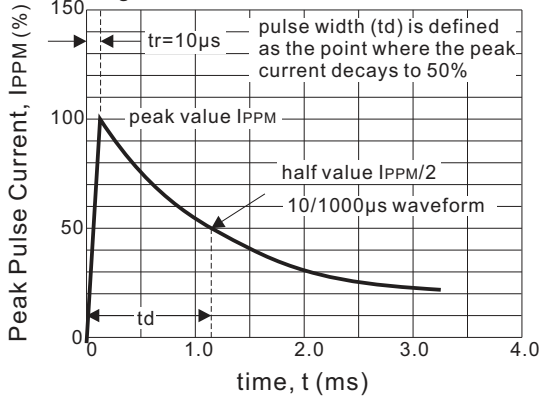

Fig.4 - Typical Junction Capacitance

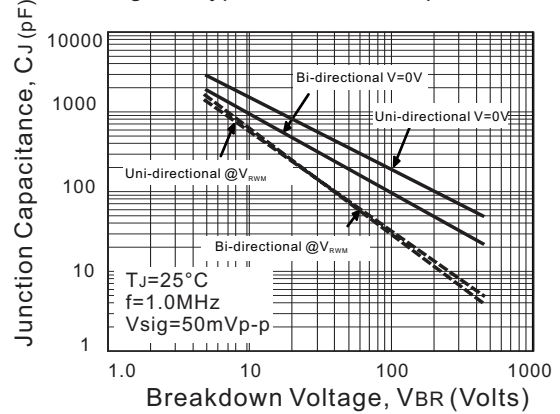

Fig.5 - Steady State Power Derating Curve

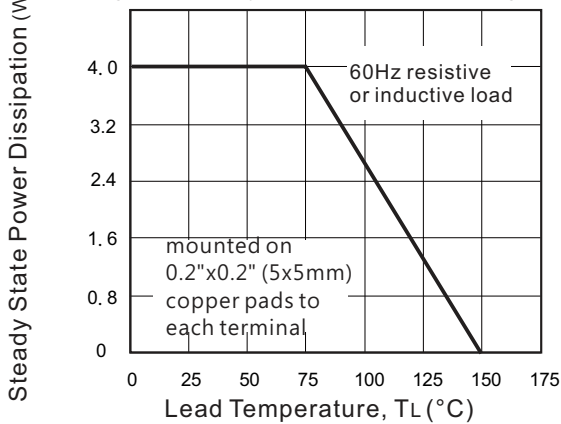
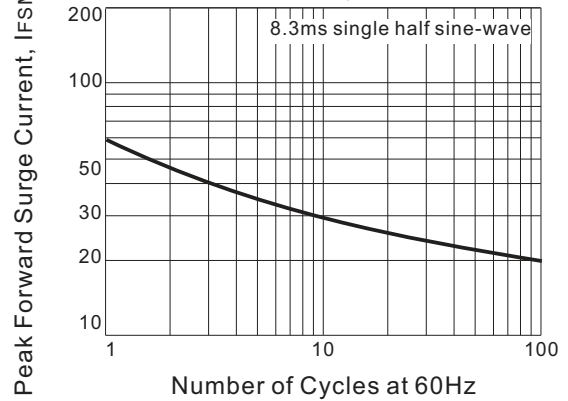

Fig.6 - Maximum Non-Repetitive Forward Surge Current



Rating and characteristic curves (SMA6SF-Q1 SERIES)

Fig. 7 - Transients of several thousand volts can be clamped to a safe level by the TVS

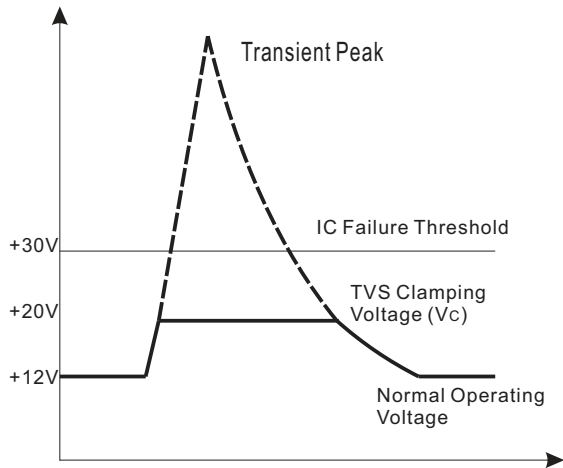
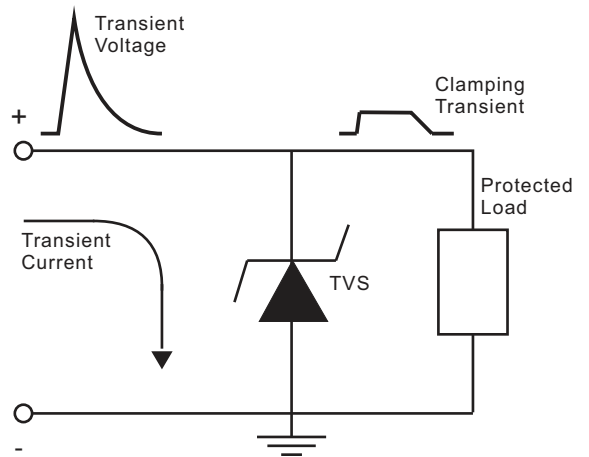

Fig. 8 - Transient current is diverted to ground thru TVS; the voltage seen by the protected load is limited to the clamping voltage level



SMA6SF5.0(C)A-Q1 THRU SMA6SF170(C)A-Q1

Pinning information

Pin	Simplified outline	Symbol
Uni-Directional Pin1 cathode Pin2 anode		
Bi-Directional		

Marking

Type number	Example
Uni-Directional	<p>Cathode band FMS logo XX=Marking code (see page 3 or page 4)</p>
Bi-Directional	<p>FMS logo XX=Marking code (see page 3 or page 4)</p>

Suggested solder pad layout

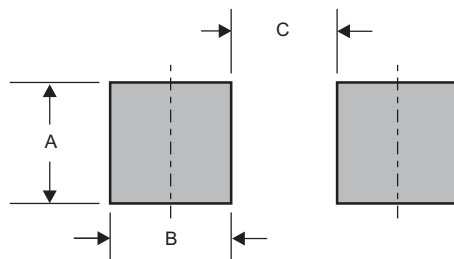

Dimensions in inches and (millimeters)

PACKAGE	A	B	C
SMA-SF	0.063 (1.60)	0.059 (1.50)	0.110 (2.80)

SMA6SF5.0(C)A-Q1 THRU SMA6SF170(C)A-Q1

Packing information

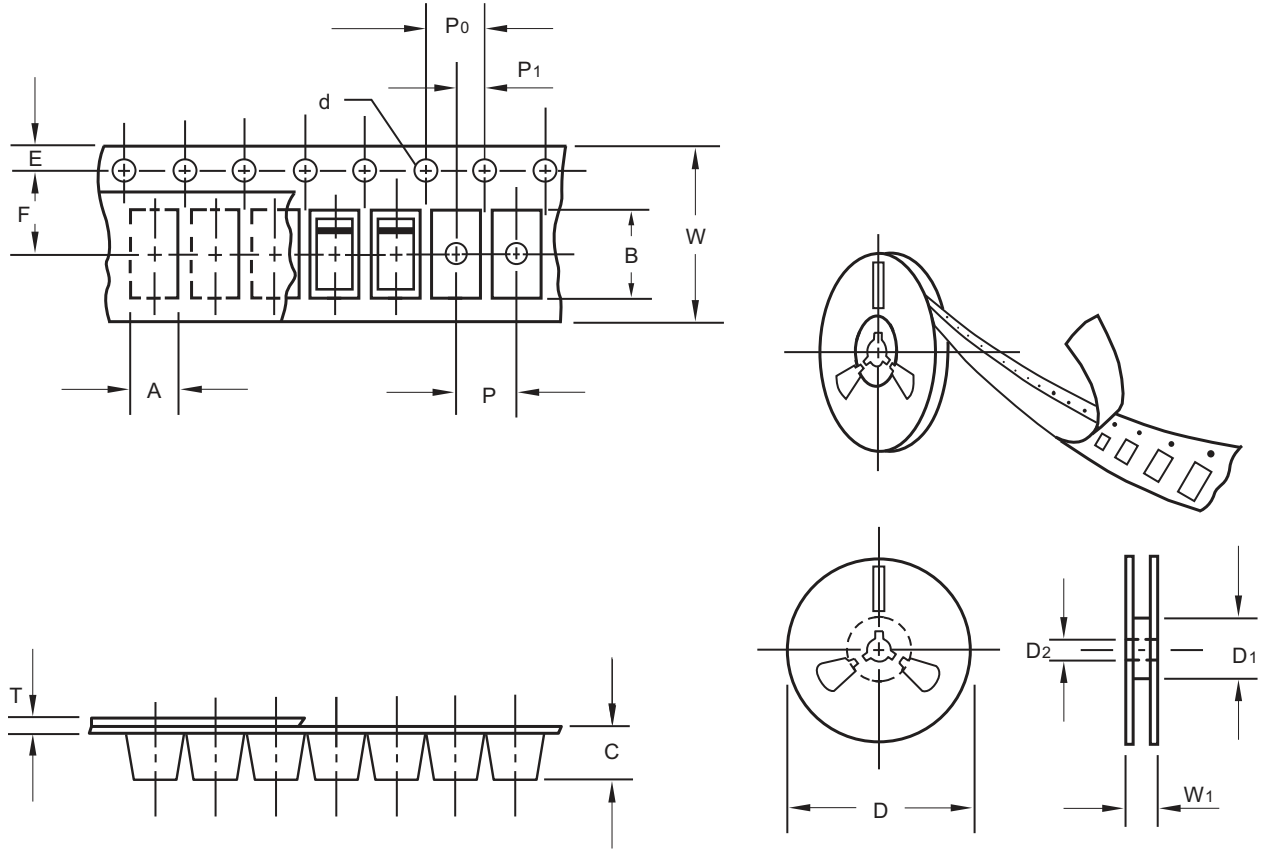

unit:mm

Item	Symbol	Tolerance	SMA-SF
Carrier width	A	0.1	2.90
Carrier length	B	0.1	5.50
Carrier depth	C	0.1	2.10
Sprocket hole	d	0.1	1.50
13" Reel outside diameter	D	2.0	330.00
13" Reel inner diameter	D1	min	50.00
7" Reel outside diameter	D	2.0	178.00
7" Reel inner diameter	D1	min	62.00
Feed hole diameter	D2	0.5	13.00
Sprocket hole position	E	0.1	1.75
Punch hole position	F	0.1	5.50
Punch hole pitch	P	0.1	4.00
Sprocket hole pitch	P0	0.1	4.00
Embossment center	P1	0.1	2.00
Overall tape thickness	T	0.1	0.23
Tape width	W	0.3	12.00
Reel width	W1	1.0	18.00

Note: Devices are packed in accordance with EIA standard RS-481-A and specifications listed above.

SMA6SF5.0(C)A-Q1 THRU SMA6SF170(C)A-Q1

Reel packing

PACKAGE	REEL SIZE	REEL (pcs)	COMPONENT SPACING (m/m)	BOX (pcs)	INNER BOX (m/m)	REEL DIA, (m/m)	CARTON SIZE (m/m)	CARTON (pcs)	APPROX. GROSS WEIGHT (kg)
SMA-SF	7"	2,000	4.0	20,000	183*155*183	178	382*356*392	160,000	12.0
	13"	7,500	4.0	15,000	335*335*38	330	350*330*360	120,000	11.5

Suggested thermal profiles for soldering processes

- 1.Storage environment: Temperature=5°C~40°C Humidity=55%±25%
- 2.Reflow soldering of surface-mount devices

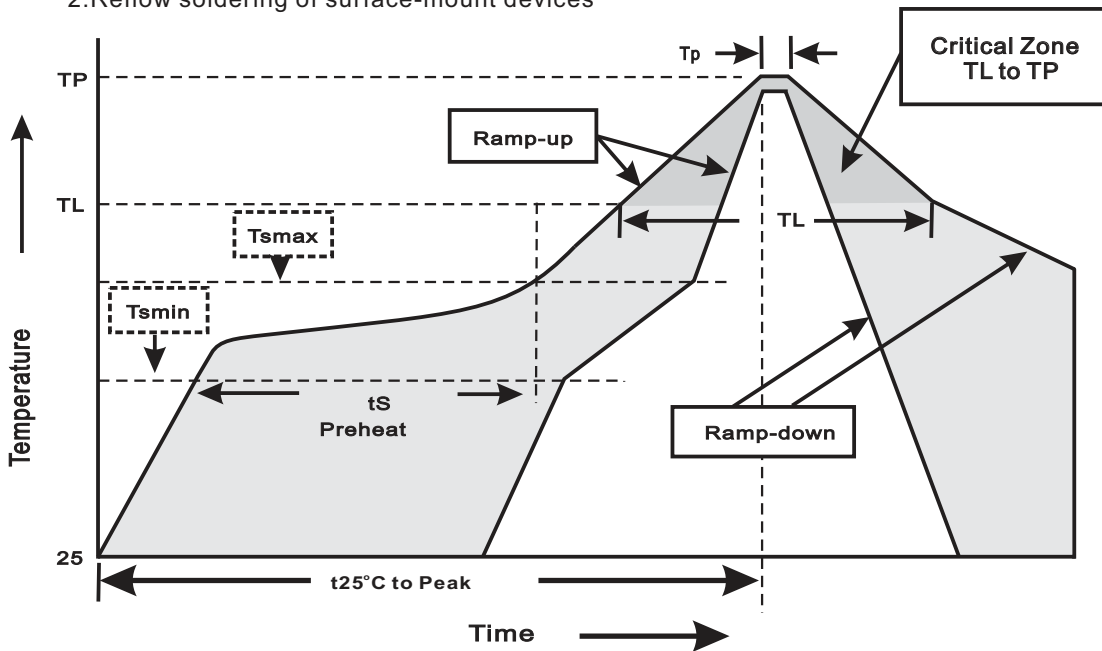

3.Reflow soldering

Profile Feature	Soldering Condition
Average ramp-up rate(TL to TP)	<3°C/sec
Preheat -Temperature Min(Tsmin) -Temperature Max(Tsmax) -Time(min to max)(ts)	150°C 200°C 60~120sec
Tsmax to TL -Ramp-upRate	<3°C/sec
Time maintained above: -Temperature(TL) -Time(tL)	217°C 60~260sec
Peak Temperature(TP)	255°C-0/+5°C
Time within 5°C of actual Peak Temperature(tp)	10~30sec
Ramp-down Rate	<6°C/sec
Time 25°C to Peak Temperature	<6minutes

SMA6SF5.0(C)A-Q1 THRU SMA6SF170(C)A-Q1

High reliability test capabilities

Item Test	Conditions	Reference
1. MSL Preconditioning	24hr bake@125°C+168hrs@85°C /85%RH+3xIR@260°C+1flux immersion+alcohol+DI H2O rinse	JESD22-A113
2. High Temperature Reverse Bias	V _{BR} =V _{BR} NOM*80% (T _j =150°C) Test Duration:1000hrs	JESD22-A108
3. High Temperature Storage Life	T _a =125°C Test Duration:1000hrs	JESD22 A-103
4. Temperature Cycle	-55°C(15min) to 150°C(15min) Test Cycles:1000cycles	JESD22 A-104
5. Autoclave	P=2atm T _a =121°C RH=100% Test Duration:96hrs	JESD22 A-102
6. Solderability	245±5°C for 5sec	J-STD-002
7. Moisture Resistance	T _a =85°C/85% Relative humidity Test Duration:1000hrs	MIL-STD-750E METHOD 1021.2
8. Resistance To Solder Heat	260±5°C for 10sec	JESD22 B-106
9. High Temperature High Humidity Reverse Bias	T _a =85°C, 85%RH, with device reverse biased at 80% of rated breakdown voltage up to a maximum of 100V or limit of chamber Test Duration:1000hrs	JESD22-A101