

<b>GlobTek, Inc.</b> www.globtek.com 186 Veterans Drive, Northvale, NJ 07647 Tel. (201) 784-1000 Fax (201) 784-0111	Drawing Title: GTM96700-B6519-F, Medical Power Supply, Efficiency Level: N/A, Case Color/Style: PCB, Open Frame/Internal, Regulated Switchmode AC-DC Power Supply AC Adaptor, Input Rating: 100-240V~, 50-60 Hz, Molex Header (or equal) , Output Rating: 62W, 19.0V@3.26A, Output Configuration: Molex 6-Pin Header PN: 22-11-2066 MATES W/ PN: 22-01-2061 or Equivalent, GT Connector # C4933, Pin Out: Pin 1,2,3: V+; Pin 4,5,6: Com/Gnd, Blades/Input Cord: (Order Separately), Approvals: ETL; ETL; CB 60601-1 2MOPP; CB 62368; S-Mark IEC/EN 60601-1 60950; CB 60950; UKCA; ETL 62368; LPS 62368; Morocco; CE; China RoHS; Class I; EAC; RoHS; Ukraine; VCCI; WEEE;	
	Model No. GTM96700-B6519-F	
	Part No./Ordering No. GTM96700-B6219-F(R)	Rev D

In Addition to GlobTek Inc.'s renewed ISO9001:2015 - Quality Management System Certification, GlobTek Inc. is now certified to:

ISO13485:2016 - Medical Devices Quality Management System Certification  
ISO14001:2015 - Environmental Management System Certification

ISO Certificates are available online at <https://www.globtek.com/iso-certificates/>

The acceptance of this specification and use of the product described in this document indicates the acceptance and binding of the customer to Globtek TERMS AND CONDITIONS (attached to the end of this document), which supersede all other agreements, terms, and conditions (<https://en.globtek.com/terms-and-conditions/>).

The purchaser of this product (Customer) agrees that it is their sole responsibility to determine suitability/fitness of the product described in this specification for their application and to take precautions for protection against any hazards attendant to the handling and use of the product.

Footnote:

GlobTek Inc. will not be liable for the safety and performance of these power supplies/battery packs if unauthorized access and repair occurs. End user should consult applicable UL, CSA or EN standards for proper installation instruction.

Limitation of Use:

GlobTek products are intended for use with commercial, medical, and/or industrial equipment only. GlobTek product are not authorized for use as mission critical components in life support hazardous environment, nuclear or aircraft applications without prior written approval from the CEO of GlobTek Inc.

Contents of this document are subject to change without prior notice.

### Customer Approval of Specification:

Please approve, sign and send back to GlobTek so we can complete order processing.  
A delay in receipt of this form will delay delivery schedule.

Company Name: _____	Customer P/N: _____
Quote Number: _____	Date: _____
Authorized Representative Name: _____	Authorized Representative Signature: _____

<b>GlobTek, Inc.</b> www.globtek.com 186 Veterans Drive, Northvale, NJ 07647 Tel. (201) 784-1000 Fax (201) 784-0111	Drawing Title: GTM96700-B6519-F, Medical Power Supply, Efficiency Level: N/A, Case Color/Style: PCB, Open Frame/Internal, Regulated Switchmode AC-DC Power Supply AC Adaptor, Input Rating: 100-240V~, 50-60 Hz, Molex Header (or equal) , Output Rating: 62W, 19.0V@3.26A, Output Configuration: Molex 6-Pin Header PN: 22-11-2066 MATES W/ PN: 22-01-2061 or Equivalent, GT Connector # C4933, Pin Out: Pin 1,2,3: V+; Pin 4,5,6: Com/Gnd, Blades/Input Cord: (Order Separately), Approvals: ETL; ETL; CB 60601-1 2MOPP; CB 62368; S-Mark IEC/EN 60601-1 60950; CB 60950; UKCA; ETL 62368; LPS 62368; Morocco; CE; China RoHS; Class I; EAC; RoHS; Ukraine; VCCI; WEEE;	
	Model No. GTM96700-B6519-F	
	Part No./Ordering No. GTM96700-B6219-F(R)	Rev D

## REVISION HISTORY

REV	DESCRIPTION	SUB	DATE	APPROVED
D	Add approvals: ETL 60950, ETL 60601-1, CB 60601-1, CB 62328-1, S 60950, S 60601-1	QA	06/13/2018	QA
C	Change output current from 3.263 to 3.26A	QA	04/20/2017	QA
B	Change o/p conn. header p/n from 22-11-2132 to 22-11-2066/change o/p conn. mate p/n from 09-50-3060 to 22-01-2061; change output pinout from Pin 1,2:V+; 3,4: N/C; 5,6: Com/Gnd to Pin 1,2,3:V+; Pin 4,5,6; add holes to heat sink to drawing; correct pin 1 designation on picture of input/output connector; add label dimensions.	rchiu	02/13/2017	QA
A	Initial release.	rchiu	08/16/2016	QA

### POWER SUPPLY INFORMATION

TYPE	Open Frame/Internal
TECHNOLOGY	Regulated Switchmode AC-DC Power Supply AC Adaptor
CASE COLOR	PCB
NAMEPLATE RATED INPUT	100-240V~, 50-60 Hz, 2.0A
INPUT CONFIG	Molex Header (or equal)
WATTS	62.00
VOLTS OUT	19.0
CURRENT OUT (Amps)	3.26
BLADE/CORD INCLUDED	None (Order Separately)
BLADE/CORD INSTALLED	None :(Order Separately)
INGRESS PROTECTION	
GROUNDING CONFIGURATION	(E1) Earthed output
EFFICIENCY LEVEL	N/A
OUTPUT CONFIGURATION	Molex 6-Pin Header PN: 22-11-2066 MATES W/ PN: 22-01-2061 or Equivalent, GT Connector # C4933
CONNECTOR PIN OUT	Pin 1,2,3: V+; Pin 4,5,6: Com/Gnd
LABEL SPECS	Standard GT,L-1186
SPECIAL BARCODE LABEL MATERIAL	No
PACK SPEC	Standard OF, Individually Box
USER MANUAL	N/A User Manual

#### PROPRIETARY INFORMATION

PROPRIETARY OF GLOBTEK, INC. ANY REPRODUCTION, DISCLOSURE OR USE OF THIS DRAWING, IN WHOLE OR IN PART, IS HEREBY PROHIBITED EXCEPT AS SPECIFIED IN

WRITING BY GLOBTEK, INC. © GlobTek, Inc. 2016 - 2023

quest / 07/26/2023 5:52:42 PM GMT CLONED FROM GTM96700-B6524-F(R)

<p>GlobTek, Inc.  www.globtek.com  186 Veterans Drive,  Northvale, NJ 07647  Tel. (201) 784-1000  Fax (201) 784-0111</p>	<p>Drawing Title: GTM96700-B6519-F, Medical Power Supply, Efficiency Level: N/A, Case Color/Style: PCB, Open Frame/Internal, Regulated Switchmode AC-DC Power Supply AC Adaptor, Input Rating: 100-240V~, 50-60 Hz, Molex Header (or equal) , Output Rating: 62W, 19.0V@3.26A, Output Configuration: Molex 6-Pin Header PN: 22-11-2066 MATES W/ PN: 22-01-2061 or Equivalent, GT Connector # C4933, Pin Out: Pin 1,2,3: V+; Pin 4,5,6: Com/Gnd, Blades/Input Cord: (Order Separately), Approvals: ETL; ETL; CB 60601-1 2MOPP; CB 62368; S-Mark IEC/EN 60601-1 60950; CB 60950; UKCA; ETL 62368; LPS 62368; Morocco; CE; China RoHS; Class I; EAC; RoHS; Ukraine; VCCI; WEEE;</p>
	<p>Model No. GTM96700-B6519-F</p>
	<p>Part No./Ordering No. GTM96700-B6219-F(R) <span style="float: right;">Rev D</span></p>

Notes/Modifications/Customizations (notes in this section supersede the values shown in the standard spec)  
DIMENSIONS ARE IN MM UNLESS SPECIFIED OTHERWISE

GloTek, Inc. www.globtek.com 186 Veterans Drive, Northvale, NJ 07647 Tel. (201) 784-1000 Fax (201) 784-0111	Drawing Title: GTM96700-B6519-F, Medical Power Supply, Efficiency Level: N/A, Case Color/Style: PCB, Open Frame/Internal, Regulated Switchmode AC-DC Power Supply AC Adaptor, Input Rating: 100-240V~, 50-60 Hz, Molex Header (or equal) , Output Rating: 62W, 19.0V@3.26A, Output Configuration: Molex 6-Pin Header PN: 22-11-2066 MATES W/ PN: 22-01-2061 or Equivalent, GT Connector # C4933, Pin Out: Pin 1,2,3: V+; Pin 4,5,6: Com/Gnd, Blades/Input Cord: (Order Separately), Approvals: ETL; ETL; CB 60601-1 2MOPP; CB 62368; S-Mark IEC/EN 60601-1 60950; CB 60950; UKCA; ETL 62368; LPS 62368; Morocco; CE; China RoHS; Class I; EAC; RoHS; Ukraine; VCCI; WEEE;	
	Model No. GTM96700-B6519-F	
	Part No./Ordering No. GTM96700-B6219-F(R)	Rev D

## ELECTRICAL SPECIFICATIONS

### A) ELECTRICAL SPECIFICATIONS:

01. Input Voltage: Specified 90-264 Vac, Nameplate rated: 100-240Vac, with optional 90-305Vac, Nameplate rated: 100-277Vac
02. Input Frequency: Specified 47-63 Hz, Nameplate rated 50-60Hz
03. Output Regulation: +/- 3% measured at the output connector
04. Line Voltage Regulation: +/- 0.5% maximum measured at full load
05. Output Ripple (Vp-p): +/- 1% of output voltage, Vp-p, max
06. Turn-ON/OFF: 5% maximum, 1 mS typical recovery time for 25% step load
07. Turn-ON Delay: 1 Sec max
08. Hold-Up Time: 10 mS typical @ nominal input voltage and full load
09. Inrush Current: 30A maximum @ 115 Vac input, 60A maximum @ 230 Vac input
10. Switching Frequency: 65 KHz typical
11. Efficiency: 87% @115Vac, 89% @ 230Vac typical at full load
12. No Load Power: < 300mW @ 230Vac

### B) PROTECTION

01. Overvoltage Protection: 110% to 130% of nominal output voltage, and less than 60Vdc
02. Short Circuit/Over-load: momentary short circuit protected, output will auto recover upon removal of short
03. Input Protection: Input line fusing and 300Vac MOV

### C) SAFETY

01. Dielectric Withstand Voltage: 4000Vac / 5656Vdc from primary to secondary
02. [Output Isolation Options](#): Class I or Class II
03. Earth Leakage Current: Does not exceed 300uA in NORMAL CONDITION and 1000uA in SINGLE FAULT CONDITION
04. Output Leakage Current: Does not exceed 100uA NC(Normal condition) 300uA SFC(single fault condition)
05. Means of Protection: 2 x MOPP
06. Compliant Standards: See listings at end of this drawing for specifics

### D) EMC

EN 60601-1-2, 4<sup>th</sup> edition

Emissions, per EN 55032, EN 61000-6-3, EN 61000-6-4, CISPR11 and CISPR22

Conducted Emissions: Class B, FCC Part 15, Class B

Radiated Emissions: Class B, FCC Part 15, Class B

Line Frequency Harmonics EN61000-3-2, Class A

Voltage Fluctuations/Flicker EN61000-3-3

Immunity, per EN 55024, EN 61000-6-1, EN 61000-6-2

Static Discharge Immunity EN61000-4-2, 10kV Contact Discharge, 20kV air discharge

Radiated RF Immunity EN61000-4-3, 10V/m 80-1000MHz, 3V/m 1-2.7GHz, 80% 1KHz AM.

EFT/Burst Immunity EN61000-4-4, 4kV/100kHz.

Line Surge Immunity EN61000-4-5, 2kV differential, 4kV common-mode

Conducted RF Immunity EN61000-4-6, 3Vrms, 80% 1KHz AM

Power Frequency Magnetic Field Immunity EN61000-4-8, 3A/m

Voltage Dip Immunity EN61000-4-11, Criteria

## PROPRIETARY INFORMATION

PROPRIETARY OF GLOBTEK, INC. ANY REPRODUCTION, DISCLOSURE OR USE OF THIS DRAWING, IN WHOLE OR IN PART, IS HEREBY PROHIBITED EXCEPT AS SPECIFIED IN

WRITING BY GLOBTEK, INC. © GlobTek, Inc. 2016 - 2023

quest / 07/26/2023 5:52:42 PM GMT CLONED FROM GTM96700-B6524-F(R)

GlobTek, Inc. www.globtek.com 186 Veterans Drive, Northvale, NJ 07647 Tel. (201) 784-1000 Fax (201) 784-0111	Drawing Title: GTM96700-B6519-F, Medical Power Supply, Efficiency Level: N/A, Case Color/Style: PCB, Open Frame/Internal, Regulated Switchmode AC-DC Power Supply AC Adaptor, Input Rating: 100-240V~, 50-60 Hz, Molex Header (or equal) , Output Rating: 62W, 19.0V@3.26A, Output Configuration: Molex 6-Pin Header PN: 22-11-2066 MATES W/ PN: 22-01-2061 or Equivalent, GT Connector # C4933, Pin Out: Pin 1,2,3: V+; Pin 4,5,6: Com/Gnd, Blades/Input Cord: (Order Separately), Approvals: ETL; ETL; CB 60601-1 2MOPP; CB 62368; S-Mark IEC/EN 60601-1 60950; CB 60950; UKCA; ETL 62368; LPS 62368; Morocco; CE; China RoHS; Class I; EAC; RoHS; Ukraine; VCCI; WEEE;	
	Model No. GTM96700-B6519-F	
	Part No./Ordering No. GTM96700-B6219-F(R)	Rev D

E) OTHER

01. MTBF: 1,000,000 Hours @ 50°C ambient temperature, Full Load
02. Operating Temperature: -10°C to 50°C ambient temperature
03. Humidity: 0% to 95% relative humidity
04. Storage Temperature: -30°C to 80°C
05. Cooling: Convection
06. Elevation: 5000M
07. ROHS 2: Complies with EU 2011/65/EU and China SJ/T 11363-2006
08. Green Output Power indication LED

F) MECHANICAL FORMAT

01. Type: Open Frame
02. Size: B suffix version, (2"x4"), 101.6 x 50.8 x 30.5 mm
03. Size: C suffix version, (3"x5"), 127.0 x 76.2 x 30.5 mm

G) SPECIAL OPTIONS

01. Custom Label Markings
02. Integral Earth Wire for Class I
03. Short term Output Surge Capability
04. Reduced Leakage Current versions
05. Tightened output voltage tolerance
06. Reduced output ripple level
07. Low Temperature operation, down to -40°C
08. Over-Temperature Protection, Latched Shut-Down
09. Special Input or Output Connectors

TO ADDRESS SYSTEM-LEVEL EMI CONCERNS, FERRITE CHOKES/BEADS MAY BE ADDED/REVISED UPON REQUEST. A SAMPLE KIT OF GLOBTEK'S STANDARD FERRITES IS AVAILABLE UNDER GLOBTEK P/N: EMI-MITIGATION-KIT1

FOR ADDITIONAL INFORMATION, PLEASE READ OUR WHITE PAPER AT: <https://r.globtek.info/3QeaqtD>

PROPRIETARY INFORMATION

GlobTek, Inc.  
www.globtek.com  
186 Veterans Drive,  
Northvale, NJ 07647  
Tel. (201) 784-1000  
Fax (201) 784-0111

Drawing Title: GTM96700-B6519-F, Medical Power Supply, Efficiency Level: N/A, Case Color/Style: PCB, Open Frame/Internal, Regulated Switchmode AC-DC Power Supply AC Adaptor, Input Rating: 100-240V~, 50-60 Hz, Molex Header (or equal) , Output Rating: 62W, 19.0V@3.26A, Output Configuration: Molex 6-Pin Header PN: 22-11-2066 MATES W/ PN: 22-01-2061 or Equivalent, GT Connector # C4933, Pin Out: Pin 1,2,3: V+; Pin 4,5,6: Com/Gnd, Blades/Input Cord: (Order Separately), Approvals: ETL; ETL; CB 60601-1 2MOPP; CB 62368; S-Mark IEC/EN 60601-1 60950; CB 60950; UKCA; ETL 62368; LPS 62368; Morocco; CE; China RoHS; Class I; EAC; RoHS; Ukraine; VCCI; WEEE;

Model No. GTM96700-B6519-F

Part No./Ordering No. GTM96700-B6219-F(R)

Rev D

Mechanical drawing

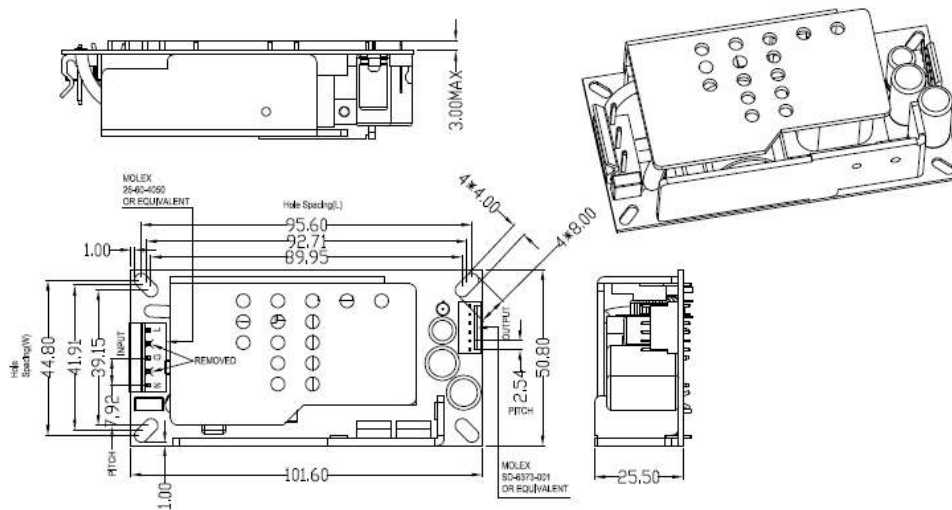

PROPRIETARY INFORMATION

GlobTek, Inc.  
 www.globtek.com  
 186 Veterans Drive,  
 Northvale, NJ 07647  
 Tel. (201) 784-1000  
 Fax (201) 784-0111

Drawing Title: GTM96700-B6519-F, Medical Power Supply, Efficiency Level: N/A, Case Color/Style: PCB, Open Frame/Internal, Regulated Switchmode AC-DC Power Supply AC Adaptor, Input Rating: 100-240V~, 50-60 Hz, Molex Header (or equal) , Output Rating: 62W, 19.0V@3.26A, Output Configuration: Molex 6-Pin Header PN: 22-11-2066 MATES W/ PN: 22-01-2061 or Equivalent, GT Connector # C4933, Pin Out: Pin 1,2,3: V+; Pin 4,5,6: Com/Gnd, Blades/Input Cord: (Order Separately), Approvals: ETL; ETL; CB 60601-1 2MOPP; CB 62368; S-Mark IEC/EN 60601-1 60950; CB 60950; UKCA; ETL 62368; LPS 62368; Morocco; CE; China RoHS; Class I; EAC; RoHS; Ukraine; VCCI; WEEE;

Model No. GTM96700-B6519-F

Part No./Ordering No. GTM96700-B6219-F(R)

Rev D

### DERATING CURVE

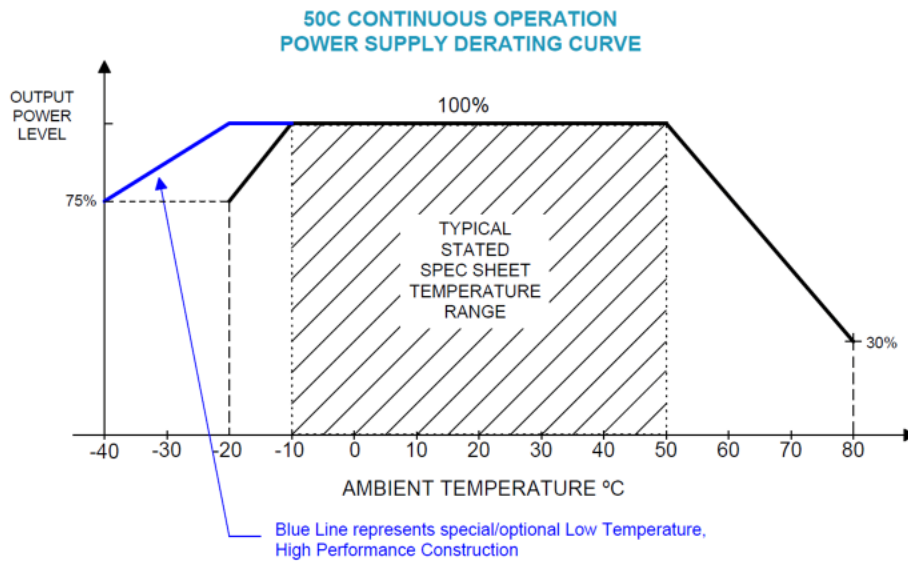

Note: Models  $\geq 24V$  may be operated at 70W continuous power, if the ambient temperature is  $\leq 40^\circ C$ .

GlobTek, Inc. www.globtek.com 186 Veterans Drive, Northvale, NJ 07647 Tel. (201) 784-1000 Fax (201) 784-0111	Drawing Title: GTM96700-B6519-F, Medical Power Supply, Efficiency Level: N/A, Case Color/Style: PCB, Open Frame/Internal, Regulated Switchmode AC-DC Power Supply AC Adaptor, Input Rating: 100-240V~, 50-60 Hz, Molex Header (or equal) , Output Rating: 62W, 19.0V@3.26A, Output Configuration: Molex 6-Pin Header PN: 22-11-2066 MATES W/ PN: 22-01-2061 or Equivalent, GT Connector # C4933, Pin Out: Pin 1,2,3: V+; Pin 4,5,6: Com/Gnd, Blades/Input Cord: (Order Separately), Approvals: ETL; ETL; CB 60601-1 2MOPP; CB 62368; S-Mark IEC/EN 60601-1 60950; CB 60950; UKCA; ETL 62368; LPS 62368; Morocco; CE; China RoHS; Class I; EAC; RoHS; Ukraine; VCCI; WEEE;	
	Model No. GTM96700-B6519-F	
	Part No./Ordering No. GTM96700-B6219-F(R)	Rev D

## INPUT CONFIGURATION

(E1) Earthed output

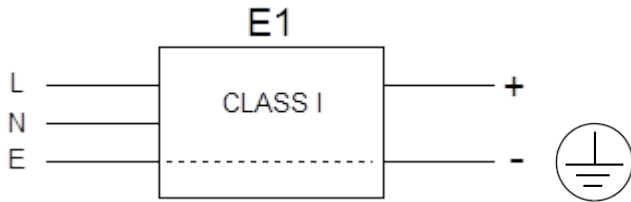

[Alternate grounding configurations](#) available upon request.

Blades/Cord Included:None:(Order Separately)

Blades/Cord Installed:None:(Order Separately)

Molex 26-60-4050 5 Position Header Pin 1: Gnd, Pin 2: Removed, PIN 3: Neutral, Pin 4: removed, Pin 5: Line

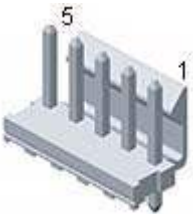

Optional Input Wiring Kits are available:

PN/Ordering No	Length	End A	End B
<a href="#">C810070M6MLX5(R)</a>	60	IEC 60320 C8 (Faston)	MOLEX 09-50-3051
<a href="#">C810070M6MLX5HW(R)</a>	60	IEC 60320 C8 (Hardwired)	MOLEX 09-50-3051
<a href="#">C1410070M6MLX5(R)</a>	60	IEC 60320 C13	MOLEX 09-50-3051
<a href="#">MLX5410070M7MLX5(R)</a>	73	MOLEX 09-50-3051	MOLEX 09-50-3051

Custom lengths, construction, cable types, ferrites, filters, and termination available upon request.

### PROPRIETARY INFORMATION

PROPRIETARY OF GLOBTEK, INC. ANY REPRODUCTION, DISCLOSURE OR USE OF THIS DRAWING, IN WHOLE OR IN PART, IS HEREBY PROHIBITED EXCEPT AS SPECIFIED IN WRITING BY GLOBTEK, INC. © GlobTek, Inc. 2016 - 2023

quest / 07/26/2023 5:52:42 PM GMT CLONED FROM GTM96700-B6524-F(R)



<b>GlobTek, Inc.</b> www.globtek.com 186 Veterans Drive, Northvale, NJ 07647 Tel. (201) 784-1000 Fax (201) 784-0111	Drawing Title: GTM96700-B6519-F, Medical Power Supply, Efficiency Level: N/A, Case Color/Style: PCB, Open Frame/Internal, Regulated Switchmode AC-DC Power Supply AC Adaptor, Input Rating: 100-240V~, 50-60 Hz, Molex Header (or equal) , Output Rating: 62W, 19.0V@3.26A, Output Configuration: Molex 6-Pin Header PN: 22-11-2066 MATES W/ PN: 22-01-2061 or Equivalent, GT Connector # C4933, Pin Out: Pin 1,2,3: V+; Pin 4,5,6: Com/Gnd, Blades/Input Cord: (Order Separately), Approvals: ETL; ETL; CB 60601-1 2MOPP; CB 62368; S-Mark IEC/EN 60601-1 60950; CB 60950; UKCA; ETL 62368; LPS 62368; Morocco; CE; China RoHS; Class I; EAC; RoHS; Ukraine; VCCI; WEEE;	
	Model No. GTM96700-B6519-F	
	Part No./Ordering No. GTM96700-B6219-F(R)	Rev D

**OUTPUT CORD AND CONNECTOR: MOL6/C4933**

ACTUAL CONNECTORS, OVERMOLDS, FERRITES MAY VARY SLIGHTLY FROM THE PICTURE BELOW

**CABLE TYPE**

CABLE LENGTH (mm)	0
CABLE TOLERANCE (mm)	0
WIRE GAUGE (AWG)	
CONDUCTORS	
HANK DIMENSION (mm)	0
CABLE / CONNECTOR OVERMOLD COLOR	
FERRITE TYPE AND DIMENSION	None
FERRITE NUMBER OF TURNS <a href="#">(Definition)</a>	N/A
FERRITE DIMENSION FROM STRAIN RELIEF	N/A
FERRITE DIMENSION FROM PLUG	N/A
PLUG TYPE	Molex 6-Pin Header PN: 22-11-2066 MATES W/ PN: 22-01-2061 or Equivalent
OVER MOLD ORIENTATION	Straight
CONNECTOR PIN OUT	Pin 1,2,3: V+; Pin 4,5,6: Com/Gnd

Optional Output Wiring Kits are available:

PN/Ordering No	Length	End A	End B
<a href="#">MLX6610070M7MLX6(R)</a>	73	Molex:22-01-2067	Molex:22-01-2067

Custom lengths, construction, cable types, ferrites, filters, and termination available upon request.

ADDITIONAL OUTPUT PLUG OPTIONS ARE AVAILABLE AT <https://www.globtek.com/connectors/>

STANDARD PLUGS AND CONNECTORS CAN BE SEEN ONLINE AT <https://www.globtek.com/connectors/>

CALCULATE VOLTAGE REGULATION/DROP WITH OUR ONLINE CALCULATOR: <https://en.globtek.com/output-cable-regulation-calculator/>

<p>GlobTek, Inc.  www.globtek.com  186 Veterans Drive,  Northvale, NJ 07647  Tel. (201) 784-1000  Fax (201) 784-0111</p>	<p>Drawing Title: GTM96700-B6519-F, Medical Power Supply, Efficiency Level: N/A, Case Color/Style: PCB, Open Frame/Internal, Regulated Switchmode AC-DC Power Supply AC Adaptor, Input Rating: 100-240V~, 50-60 Hz, Molex Header (or equal) , Output Rating: 62W, 19.0V@3.26A, Output Configuration: Molex 6-Pin Header PN: 22-11-2066 MATES W/ PN: 22-01-2061 or Equivalent, GT Connector # C4933, Pin Out: Pin 1,2,3: V+; Pin 4,5,6: Com/Gnd, Blades/Input Cord: (Order Separately), Approvals: ETL; ETL; CB 60601-1 2MOPP; CB 62368; S-Mark IEC/EN 60601-1 60950; CB 60950; UKCA; ETL 62368; LPS 62368; Morocco; CE; China RoHS; Class I; EAC; RoHS; Ukraine; VCCI; WEEE;</p>
	<p>Model No. GTM96700-B6519-F</p>
	<p>Part No./Ordering No. GTM96700-B6219-F(R) <span style="float: right;">Rev D</span></p>

## OUTPUT CONNECTOR HOOK UP

TO ADDRESS SYSTEM-LEVEL EMI CONCERNS, FERRITE CHOKES/BEADS MAY BE ADDED/REVISED UPON REQUEST. A SAMPLE KIT OF GLOBTEK'S STANDARD FERRITES IS AVAILABLE UNDER GLOBTEK P/N: EMI-MITIGATION-KIT1

FOR ADDITIONAL INFORMATION, PLEASE READ OUR WHITE PAPER AT:

<https://en.globtek.com/technical-articles/ferrite-kit-radiated-emi-suppression-kit-for-globtek-power-supplies-cable-assemblies>

<b>GlobTek, Inc.</b> www.globtek.com 186 Veterans Drive, Northvale, NJ 07647 Tel. (201) 784-1000 Fax (201) 784-0111	Drawing Title: GTM96700-B6519-F, Medical Power Supply, Efficiency Level: N/A, Case Color/Style: PCB, Open Frame/Internal, Regulated Switchmode AC-DC Power Supply AC Adaptor, Input Rating: 100-240V~, 50-60 Hz, Molex Header (or equal) , Output Rating: 62W, 19.0V@3.26A, Output Configuration: Molex 6-Pin Header PN: 22-11-2066 MATES W/ PN: 22-01-2061 or Equivalent, GT Connector # C4933, Pin Out: Pin 1,2,3: V+; Pin 4,5,6: Com/Gnd, Blades/Input Cord: (Order Separately), Approvals: ETL; ETL; CB 60601-1 2MOPP; CB 62368; S-Mark IEC/EN 60601-1 60950; CB 60950; UKCA; ETL 62368; LPS 62368; Morocco; CE; China RoHS; Class I; EAC; RoHS; Ukraine; VCCI; WEEE;	
	Model No. GTM96700-B6519-F	
	Part No./Ordering No. GTM96700-B6219-F(R)	Rev D

**LABEL:L-1186**

LABEL P/N	Standard GT
MATERIAL	Flat Thermal Transfer, Imprintable, Polyester Label and/or Pad Printed and/or Molded, and/or Laser Engraved in the case
BACKGROUND COLOR	Black if housing is Black, White or Silver if housing is White or Gray.
TEXT COLOR	White or Silver if label is Black Background for Black housing. Black if label is White or Silver background and Housing is White or Gray.
LABEL WIDTH (mm)	38.0
LABEL HEIGHT (mm)	18.0
SPECIAL BARCODE LABEL MATERIAL	No

Below is the minimum information which will appear on the label. NOTE: in the logo area additional/actual positioning of symbols and text is subjected to change as per agency updates/requirements or additional model approvals become available.  
 Regulatory certifications/label markings may be in logo area on the label or molded into the case housing outside the label area.  
 Information will be shown via label and/or pad printed and/or molded and/or laser engraved in the case. \* Date code markings at GlobTek option

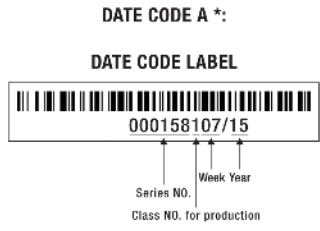

or  
**DATE CODE B \*:**  
 WWYY  
 WW = WEEK  
 YY = YEAR

- A=Medical Power Supply
- B=P/N: (料号) GTM96700-B6219-F(R)
- C=Model (型号) GTM96700-B6519-F
- D=Input (输入)100-240V~, 50-60 Hz, 2.0A
- E=Output (输出)19.0 V 3.26 A, 62.00W

<b>GlobTek, Inc.</b> www.globtek.com 186 Veterans Drive, Northvale, NJ 07647 Tel. (201) 784-1000 Fax (201) 784-0111	Drawing Title: GTM96700-B6519-F, Medical Power Supply, Efficiency Level: N/A, Case Color/Style: PCB, Open Frame/Internal, Regulated Switchmode AC-DC Power Supply AC Adaptor, Input Rating: 100-240V~, 50-60 Hz, Molex Header (or equal) , Output Rating: 62W, 19.0V@3.26A, Output Configuration: Molex 6-Pin Header PN: 22-11-2066 MATES W/ PN: 22-01-2061 or Equivalent, GT Connector # C4933, Pin Out: Pin 1,2,3: V+; Pin 4,5,6: Com/Gnd, Blades/Input Cord: (Order Separately), Approvals: ETL; ETL; CB 60601-1 2MOPP; CB 62368; S-Mark IEC/EN 60601-1 60950; CB 60950; UKCA; ETL 62368; LPS 62368; Morocco; CE; China RoHS; Class I; EAC; RoHS; Ukraine; VCCI; WEEE;	
	Model No. GTM96700-B6519-F	
	Part No./Ordering No. GTM96700-B6219-F(R)	Rev D

AGENCY ONLINE DOCUMENTS	<a href="http://www.globtek.info/certs/GTM96700/">http://www.globtek.info/certs/GTM96700/</a>
CE EC-Declaration for Medical	<a href="#">Contact GlobTek for more information</a>
CE EC-Declaration for Industrial/Commercial/ITE	<a href="http://globtek.force.com/models/ec_declaration_product?id=01ta0000006xR61&amp;i=3">http://globtek.force.com/models/ec_declaration_product?id=01ta0000006xR61&amp;i=3</a>
CE EC-Declaration for Household	<a href="#">Contact GlobTek for more information</a>
UKCA-Declaration for Medical	<a href="#">Contact GlobTek for more information</a>
UKCA-Declaration for Industrial/Commercial/ITE	<a href="http://globtek.force.com/models/ukca_declaration_product?id=01ta0000006xR61&amp;i=3">http://globtek.force.com/models/ukca_declaration_product?id=01ta0000006xR61&amp;i=3</a>
UKCA-Declaration for Household	<a href="#">Contact GlobTek for more information</a>
Morocco SDoC Declaration	<a href="https://globtek.secure.force.com/models/Morocco_SDoC_Declaration?id=a0Oa000000MEOnCEAH">https://globtek.secure.force.com/models/Morocco_SDoC_Declaration?id=a0Oa000000MEOnCEAH</a>
RoHS/RoHS3 Declaration	<a href="https://www.globtek.com/pdf/rohs_cert/01ta0000006xR61AAE">https://www.globtek.com/pdf/rohs_cert/01ta0000006xR61AAE</a>
REACH Declaration	<a href="https://www.globtek.com/pdf/iso_certificates/REACH.pdf">https://www.globtek.com/pdf/iso_certificates/REACH.pdf</a>
Conflict Minerals Declaration	<a href="https://www.globtek.com/pdf/conflict-minerals.pdf">https://www.globtek.com/pdf/conflict-minerals.pdf</a>
Prop 65 Statement	<a href="https://en.globtek.com/prop-65-statement.pdf">https://en.globtek.com/prop-65-statement.pdf</a>
IPXY rating is based on 3rd party testing and customers should check suitability and test system level IPXY rating before ordering.	

## Regulatory Certifications/Label Markings

Below follows a link to the latest regulatory certifications and marks for this specific product. National standards as well as certification schemes are constantly changing and so is the set of certification marks and symbols applicable to this product. Various standards, marks and symbols, and certificates are subject to change at any time without notice.

Additional standards or unique country certifications are available upon request. Please contact Globtek to request a quotation.

LATEST PRODUCT/MODEL CERTIFICATIONS:	<a href="https://www.globtek.com/datasheet/w70961">https://www.globtek.com/datasheet/w70961</a>
AGENCY ONLINE DOCUMENTS	<a href="http://www.globtek.info/certs/GTM96700/">http://www.globtek.info/certs/GTM96700/</a>



(E1) Earthed output

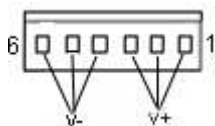

Pin 1,2,3: V+; Pin 4,5,6: Com/Gnd

### PROPRIETARY INFORMATION

<b>GlobTek, Inc.</b> www.globtek.com 186 Veterans Drive, Northvale, NJ 07647 Tel. (201) 784-1000 Fax (201) 784-0111	Drawing Title: GTM96700-B6519-F, Medical Power Supply, Efficiency Level: N/A, Case Color/Style: PCB, Open Frame/Internal, Regulated Switchmode AC-DC Power Supply AC Adaptor, Input Rating: 100-240V~, 50-60 Hz, Molex Header (or equal) , Output Rating: 62W, 19.0V@3.26A, Output Configuration: Molex 6-Pin Header PN: 22-11-2066 MATES W/ PN: 22-01-2061 or Equivalent, GT Connector # C4933, Pin Out: Pin 1,2,3: V+; Pin 4,5,6: Com/Gnd, Blades/Input Cord: (Order Separately), Approvals: ETL; ETL; CB 60601-1 2MOPP; CB 62368; S-Mark IEC/EN 60601-1 60950; CB 60950; UKCA; ETL 62368; LPS 62368; Morocco; CE; China RoHS; Class I; EAC; RoHS; Ukraine; VCCI; WEEE;	
	Model No. GTM96700-B6519-F	
	Part No./Ordering No. GTM96700-B6219-F(R)	Rev D

## PACKAGING

Packing Spec P/N	Standard OF, Individually Box
Box Qty	72
Gift Box Size (mm)	110*60*40
Gift Box Color	White
Master Carton Size (mm)	380 x 380 x 250
Master Carton Cubic Volume (m³)	0.04
Master GW (Kg)	15.2 kg
BLADES INCLUDED	None: (Order Separately)
BLADE/CORD INSTALLED	None: (Order Separately)
USER MANUAL*	N/A User Manual
USER MANUAL WEB LINK	

\* This specification sheet is considered the user manual for all applications. It is expected that the buyer of this product will use it to formulate their own user manual for their end product and a user manual specifically for the power adapter is not usually required. If a user manual is not specifically listed above then none will be provided with this unit.

If specific packaging is required, this section must specify all requirements and note "no exceptions". If this section does not specify packaging, it is subject to change without notice at GlobTek's discretion  
(Power Supply in picture for reference only)

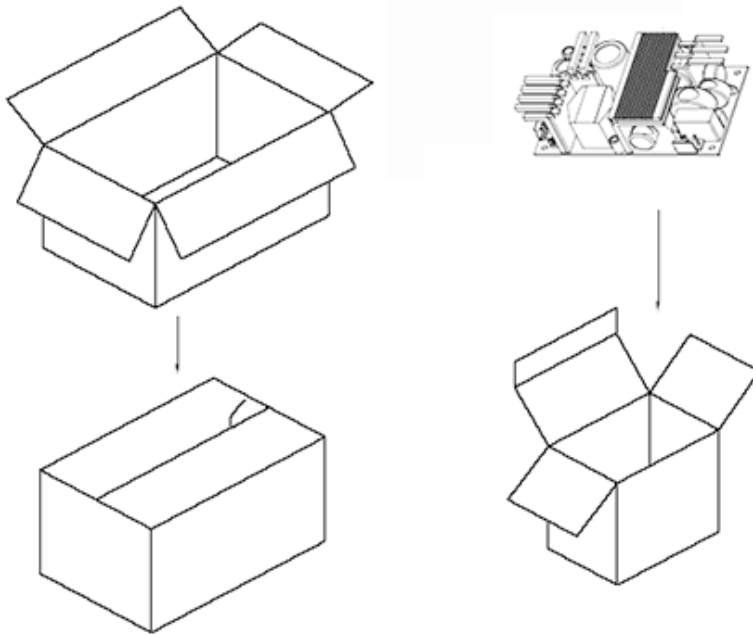

### PROPRIETARY INFORMATION

GlobTek, Inc. www.globtek.com 186 Veterans Drive, Northvale, NJ 07647 Tel. (201) 784-1000 Fax (201) 784-0111	Drawing Title: GTM96700-B6519-F, Medical Power Supply, Efficiency Level: N/A, Case Color/Style: PCB, Open Frame/Internal, Regulated Switchmode AC-DC Power Supply AC Adaptor, Input Rating: 100-240V~, 50-60 Hz, Molex Header (or equal) , Output Rating: 62W, 19.0V@3.26A, Output Configuration: Molex 6-Pin Header PN: 22-11-2066 MATES W/ PN: 22-01-2061 or Equivalent, GT Connector # C4933, Pin Out: Pin 1,2,3: V+; Pin 4,5,6: Com/Gnd, Blades/Input Cord: (Order Separately), Approvals: ETL; ETL; CB 60601-1 2MOPP; CB 62368; S-Mark IEC/EN 60601-1 60950; CB 60950; UKCA; ETL 62368; LPS 62368; Morocco; CE; China RoHS; Class I; EAC; RoHS; Ukraine; VCCI; WEEE;	
	Model No. GTM96700-B6519-F	
	Part No./Ordering No. GTM96700-B6219-F(R)	Rev D

### INSTRUCTIONS TO THE OEM SYSTEMS ENGINEER

It is the responsibility of the OEM systems engineer to provide the end system user instructions and warnings for the use of this product in the end system.

If an input cord is required for this product, AC Mains voltage should be provided to the power supply by a power supply cord approved to the national standards of the country in which it will be used.

This product is not designed to be repaired. No serviceable parts inside. A blown internal fuse is an indication of catastrophic failure of circuit component(s). If a Failure Analysis is required for a failed power supply/battery charger, please return the damaged unit to GlobTek for an accurate determination of the root cause of the failure.

EMC Compliance of the complete OEM product, including the GlobTek power supply/battery charger needs to be verified by the OEM systems engineer.

### INSTRUCTION SHEET

N/A

<p>GlobTek, Inc.  www.globtek.com  186 Veterans Drive,  Northvale, NJ 07647  Tel. (201) 784-1000  Fax (201) 784-0111</p>	<p>Drawing Title: GTM96700-B6519-F, Medical Power Supply, Efficiency Level: N/A, Case Color/Style: PCB, Open Frame/Internal, Regulated Switchmode AC-DC Power Supply AC Adaptor, Input Rating: 100-240V~, 50-60 Hz, Molex Header (or equal) , Output Rating: 62W, 19.0V@3.26A, Output Configuration: Molex 6-Pin Header PN: 22-11-2066 MATES W/ PN: 22-01-2061 or Equivalent, GT Connector # C4933, Pin Out: Pin 1,2,3: V+; Pin 4,5,6: Com/Gnd, Blades/Input Cord: (Order Separately), Approvals: ETL; ETL; CB 60601-1 2MOPP; CB 62368; S-Mark IEC/EN 60601-1 60950; CB 60950; UKCA; ETL 62368; LPS 62368; Morocco; CE; China RoHS; Class I; EAC; RoHS; Ukraine; VCCI; WEEE;</p>
	<p>Model No. GTM96700-B6519-F</p>
	<p>Part No./Ordering No. GTM96700-B6219-F(R) <span style="float: right;">Rev D</span></p>

