

54011-3 ✓ ACTIVE

AMP | AMP CPC

TE Internal #: 54011-3

Circular Connector Seals, Cable Seal, Cable Range .4 – .875 in [10.16 – 22.22 mm], .9375-20 UNEF-2B, -55 – 110 °C [-67 – 230 °F], Black, AMP CPC

[View on TE.com >](#)



[Connectors](#) > [Circular Connectors](#) > [Circular Connector Accessories](#) > [Circular Connector Seals](#) > [CPC Heat Shrink Strain Reliefs](#)

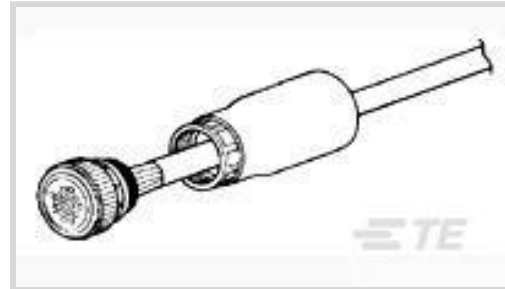

Connector Seal & Plug Type: **Cable Seal**

Compatible Cable Diameter Range: **10.16 – 22.22 mm [.4 – .875 in]**

Thread Size: **.9375-20 UNEF-2B**

Operating Temperature Range: **-55 – 110 °C [-67 – 230 °F]**

Primary Product Color: **Black**

[All CPC Heat Shrink Strain Reliefs \(7\)](#)

Features

Product Type Features

Connector Seal & Plug Type	Cable Seal
----------------------------	------------

Body Features

Primary Product Color	Black
-----------------------	-------

Mechanical Attachment

Thread Size	.9375-20 UNEF-2B
-------------	------------------

Dimensions

Compatible Cable Diameter Range	10.16 – 22.22 mm [.4 – .875 in]
---------------------------------	---------------------------------

Usage Conditions

Operating Temperature Range	-55 – 110 °C [-67 – 230 °F]
Operating Temperature (Max)	110 °C [230 °F]

Packaging Features

Packaging Quantity	50
Packaging Method	Package

Product Compliance

[For compliance documentation, visit the product page on TE.com>](#)



EU RoHS Directive 2011/65/EU	Compliant
EU ELV Directive 2000/53/EC	Compliant
China RoHS 2 Directive MIIT Order No 32, 2016	No Restricted Materials Above Threshold
EU REACH Regulation (EC) No. 1907/2006	Current ECHA Candidate List: JUNE 2023 (235) Candidate List Declared Against: JAN 2023 (233) Does not contain REACH SVHC
Halogen Content	BFR/CFR/PVC Free, but Br/Cl >900 ppm in other sources.
Solder Process Capability	Not applicable for solder process capability

Product Compliance Disclaimer

This information is provided based on reasonable inquiry of our suppliers and represents our current actual knowledge based on the information they provided. This information is subject to change. The part numbers that TE has identified as EU RoHS compliant have a maximum concentration of 0.1% by weight in homogenous materials for lead, hexavalent chromium, mercury, PBB, PBDE, DBP, BBP, DEHP, DIBP, and 0.01% for cadmium, or qualify for an exemption to these limits as defined in the Annexes of Directive 2011/65/EU (RoHS2). Finished electrical and electronic equipment products will be CE marked as required by Directive 2011/65/EU. Components may not be CE marked. Additionally, the part numbers that TE has identified as EU ELV compliant have a maximum concentration of 0.1% by weight in homogenous materials for lead, hexavalent chromium, and mercury, and 0.01% for cadmium, or qualify for an exemption to these limits as defined in the Annexes of Directive 2000/53/EC (ELV). Regarding the REACH Regulation, the information TE provides on SVHC in articles for this part number is based on the latest European Chemicals Agency (ECHA) 'Guidance on requirements for substances in articles' posted at this URL: <https://echa.europa.eu/guidance-documents/guidance-on-reach>

Compatible Parts



TE Part # CAT-AM71-C83998AA
Two-Piece Receptacle, CPC Series 6



TE Part # CAT-AM71-C83998Y
One-Piece Connector, Sealed, CPC Series 1



TE Part # CAT-AM71-C83998BB
CPC SERIES 3



TE Part # CAT-AM71-C83998U
Environmentally Sealed Circular Connector, CPC Series 5



TE Part # CAT-AM71-C83998J
Cable/Panel Mount Connector, CPC Series 1



TE Part # CAT-AM71-C83998K
Circular Connector, Environmentally Sealed, CPC Series 6



TE Part # CAT-AM71-C83998M
CPC Connectors, Series 2



TE Part # CAT-AM71-C83998X
Sealed Two-Piece Connector, CPC Series 6



Also in the Series | AMP CPC

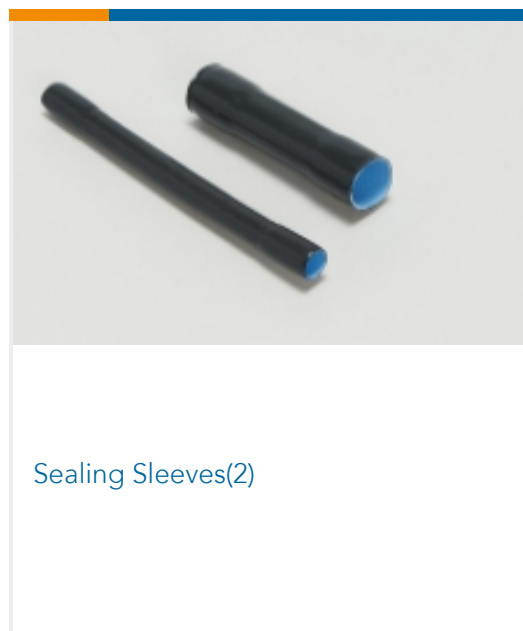
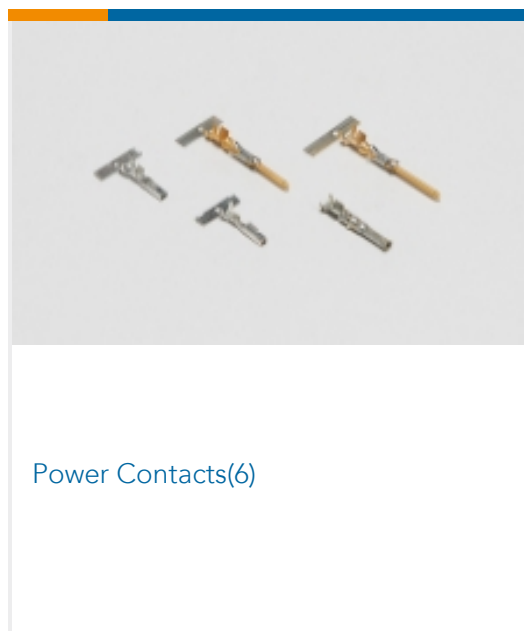
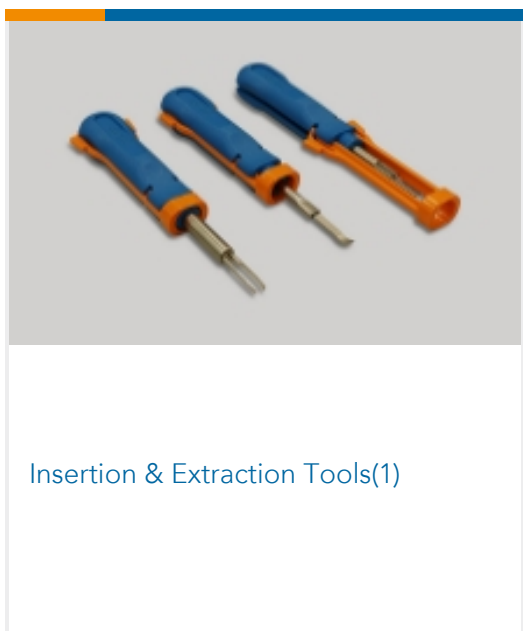
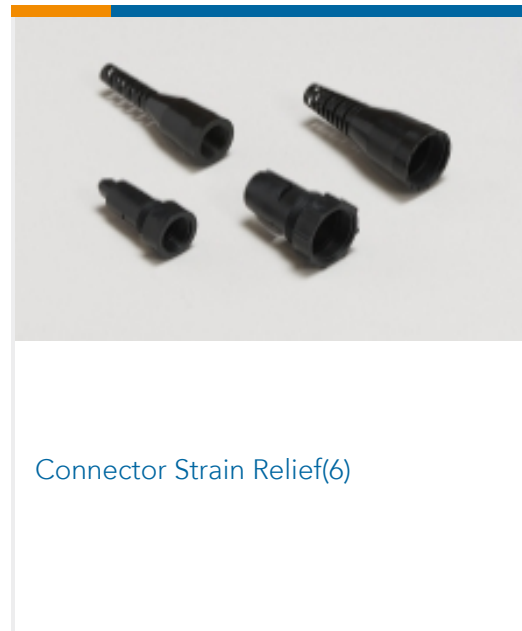
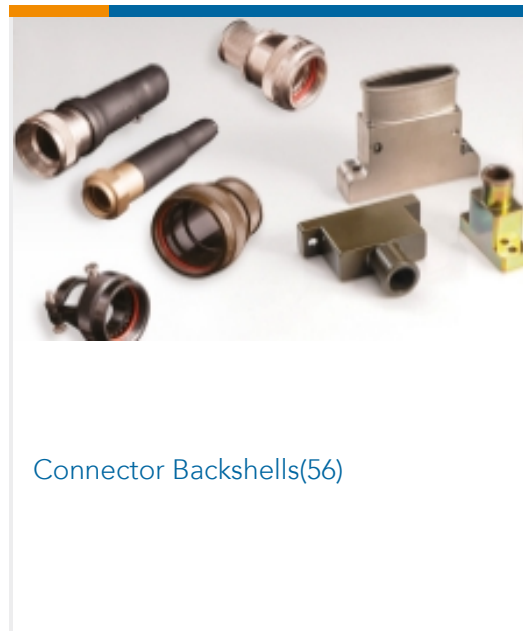
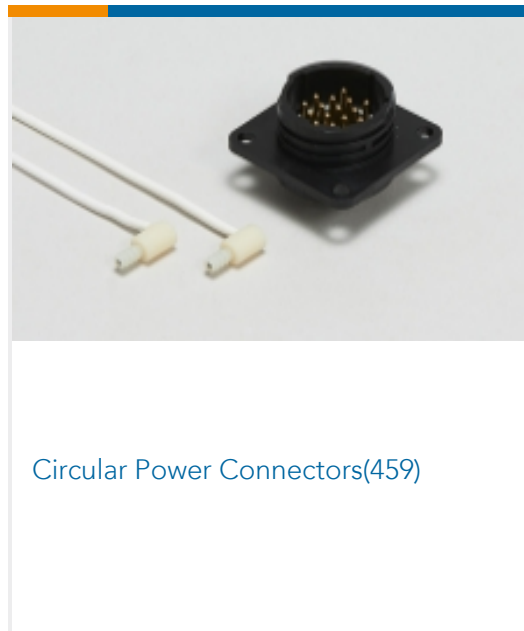
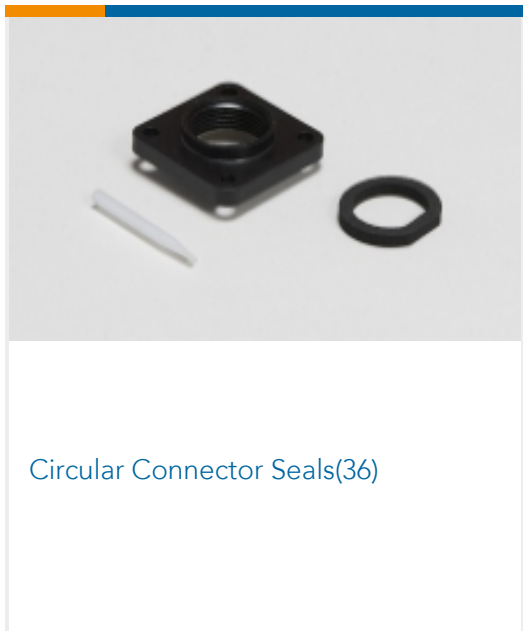
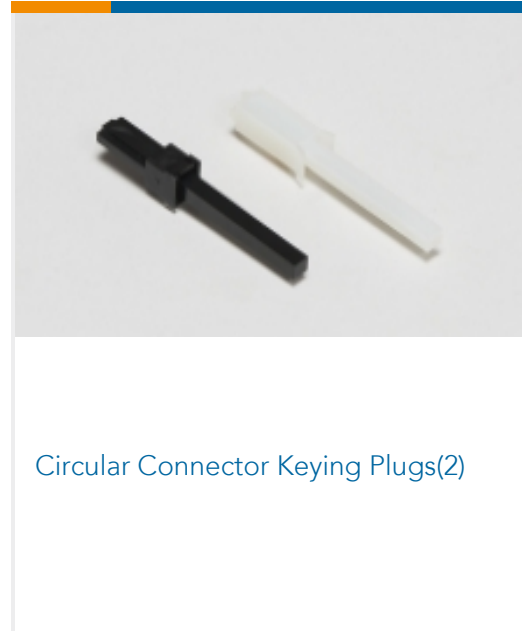
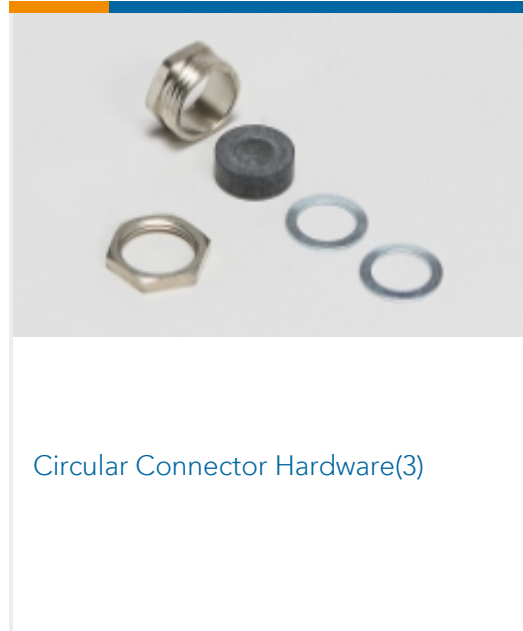
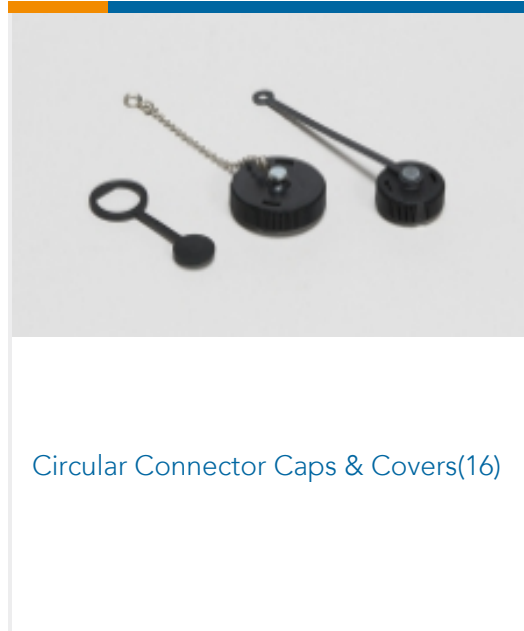
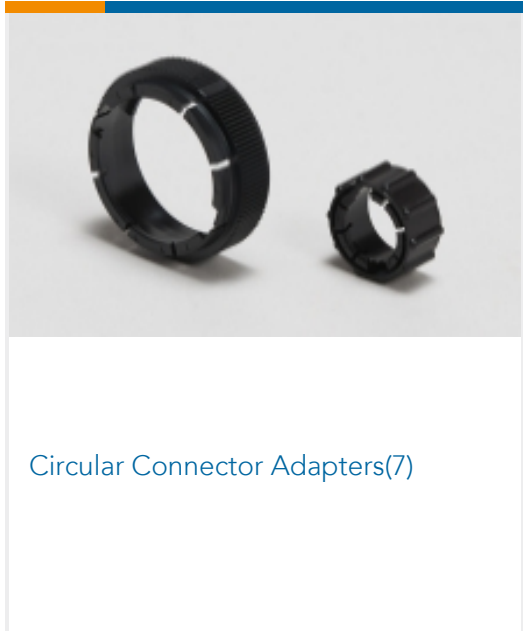

Customers Also Bought

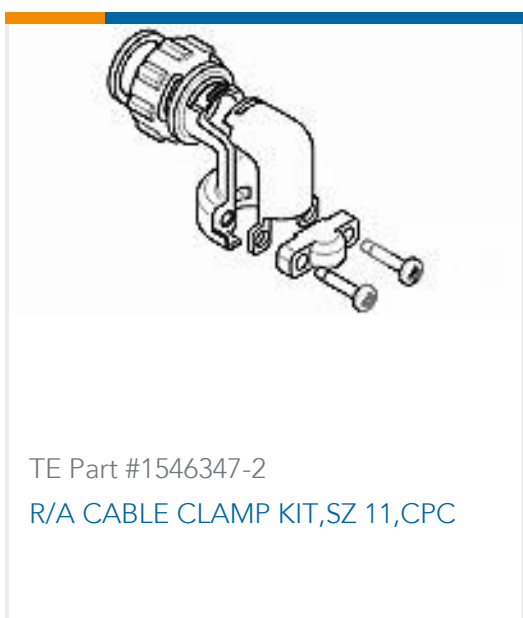



TE Part #34162
TERMINAL,PG R 16-14 1/4



TE Part #1-66105-6
III+ SKT,24-20,TIN-LEAD,SMPACK

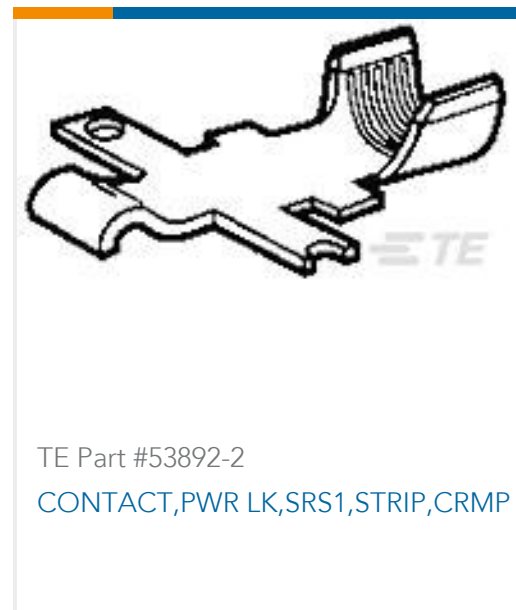

TE Part #53892-2
CONTACT,PWR LK,SRS1,STRIP,CRMP



TE Part #5-66461-4
SKT,.062 DIA,.025 SQ POST,LP



TE Part #1-66360-3
III+ SKT,18-14,TIN,SMPACK

Documents

Product Drawings

[CPC STRAIN RELIEF,SIZE 17](#)

English

CAD Files

[3D PDF](#)

English

Customer View Model

[ENG_CVM_54011-3_AB.3d_igs.zip](#)

English

Customer View Model

[ENG_CVM_54011-3_AB.3d_stp.zip](#)

English

Customer View Model

[ENG_CVM_54011-3_AB.2d_dxf.zip](#)

English

[3D PDF](#)

3D

Customer View Model

[ENG_CVM_CVM_54011-3_Z.2d_dxf.zip](#)

English

Customer View Model

[ENG_CVM_CVM_54011-3_Z.3d_igs.zip](#)

English

Customer View Model

[ENG_CVM_CVM_54011-3_Z.3d_stp.zip](#)

English



By downloading the CAD file I accept and agree to the [Terms and Conditions](#) of use.

Datasheets & Catalog Pages

[AMP Circular Connectors for Commercial Signal & Power Applications Continued](#)

English

Agency Approvals

[CSA Certificate](#)

English

[CSA Certificate](#)

English