

Antenna

YB0033AA Datasheet

Antenna Services

Version: 1.0

Date: 2021-07-05

Status: Released



Our aim is to provide customers with timely and comprehensive service. For any assistance, please contact our company headquarters:

Quectel Wireless Solutions Co., Ltd.

Building 5, Shanghai Business Park Phase III (Area B), No.1016 Tianlin Road, Minhang District, Shanghai 200233, China

Tel: +86 21 5108 6236

Email: info@quectel.com

Or our local office. For more information, please visit:

<http://www.quectel.com/support/sales.htm>.

For technical support, or to report documentation errors, please visit:

<http://www.quectel.com/support/technical.htm>

Or email to support@quectel.com.

General Notes

Quectel offers the information as a service to its customers. The information provided is based upon customers' requirements. Quectel makes every effort to ensure the quality of the information it makes available. Quectel does not make any warranty as to the information contained herein, and does not accept any liability for any injury, loss or damage of any kind incurred by use of or reliance upon the information. All information supplied herein is subject to change without prior notice.

Disclaimer

While Quectel has made efforts to ensure that the functions and features under development are free from errors, it is possible that these functions and features could contain errors, inaccuracies and omissions. Unless otherwise provided by valid agreement, Quectel makes no warranties of any kind, implied or express, with respect to the use of features and functions under development. To the maximum extent permitted by law, Quectel excludes all liability for any loss or damage suffered in connection with the use of the functions and features under development, regardless of whether such loss or damage may have been foreseeable.

Duty of Confidentiality

The Receiving Party shall keep confidential all documentation and information provided by Quectel, except when the specific permission has been granted by Quectel. The Receiving Party shall not access or use Quectel's documentation and information for any purpose except as expressly provided herein. Furthermore, the Receiving Party shall not disclose any of the Quectel's documentation and information to any third party without the prior written consent by Quectel. For any noncompliance to the above requirements, unauthorized use, or other illegal or malicious use of the documentation and information, Quectel will reserve the right to take legal action.

Copyright

The information contained here is proprietary technical information of Quectel. Transmitting, reproducing, disseminating and editing this document as well as using the content without permission are forbidden. Offenders will be held liable for payment of damages. All rights are reserved in the event of a patent grant or registration of a utility model or design.

Copyright © Quectel Wireless Solutions Co., Ltd. 2021. All rights reserved.

About the Document

Revision History

Version	Date	Author	Note
-	2021-07-05	Kenny YIN/ Aria CHU	Creation of the document
1.0	2021-07-05	Kenny YIN/ Aria CHU	First official release

Contents

About the Document.....	4
Contents.....	5
1 Product Description.....	6
2 Product Features	6
3 Product Specifications.....	7
4 Overall Performance.....	8
4.1. Test Environment	8
4.2. VSWR.....	9
4.2.1. LTE MIMO 1	9
4.2.2. LTE MIMO 2	10
4.3. Efficiency.....	11
4.3.1. LTE MIMO 1	11
4.3.2. LTE MIMO 2	12
4.4. Gain.....	13
4.4.1. LTE MIMO 1	13
4.4.2. LTE MIMO 2	14
4.5. Radiation Pattern	15
4.5.1. LTE MIMO 1	15
4.5.2. LTE MIMO 2	17
4.6. GNSS Antenna.....	19
4.7. Insulation.....	21
5 Product Size	22
6 Connect Description.....	22
7 Installation	23

1 Product Description

The antenna is designed for superior performance, and can be widely used for wireless applications.

We provide comprehensive antenna design support such as simulation, testing and manufacturing for custom antenna solutions to meet your specific application needs.

2 Product Features

- Cellular LTE; GPS L1
- High efficiency
- Excellent performance

3 Product Specifications

LTE Electrical Specifications

Frequency Range	700–2700 MHz
Input Impedence	50 Ω
VSWR	≤ 3
Gain	≤ 3.0 dBi
Polarization Type	Linear

GPS L1 Antenna Electrical Specifications

Frequency Range	GPS L1: 1575 ±3 MHz
Working Voltage	3–5 V
Working Current	9 ±3 mA @ 3 V
Gain	20 ±3 dB
Noise Figure	≤ 2 dB
VSWR	≤ 2
Input Impedence	50 Ω
Polarization Type	RHCP

Mechanical Specifications

Antenna Box Size	Φ 120 mm × 43 mm
Casing	KIBILAC® ASA
Connector Type	SMA Male (Center Pin)
Working Temperature	-20 °C to +85 °C
Radome Color	Black
IP Rating	IP67
Mounting Type	Screw

4 Overall Performance

4.1. Test Environment

- KEYSIGHT VNA Network Analyzer E5063A 100 kHz – 8.5 GHz
- RayZone® 2800 Chamber 5G (FR1) SISO/MIMO, 400 MHz – 8.0 GHz



4.2. VSWR

4.2.1. LTE MIMO 1

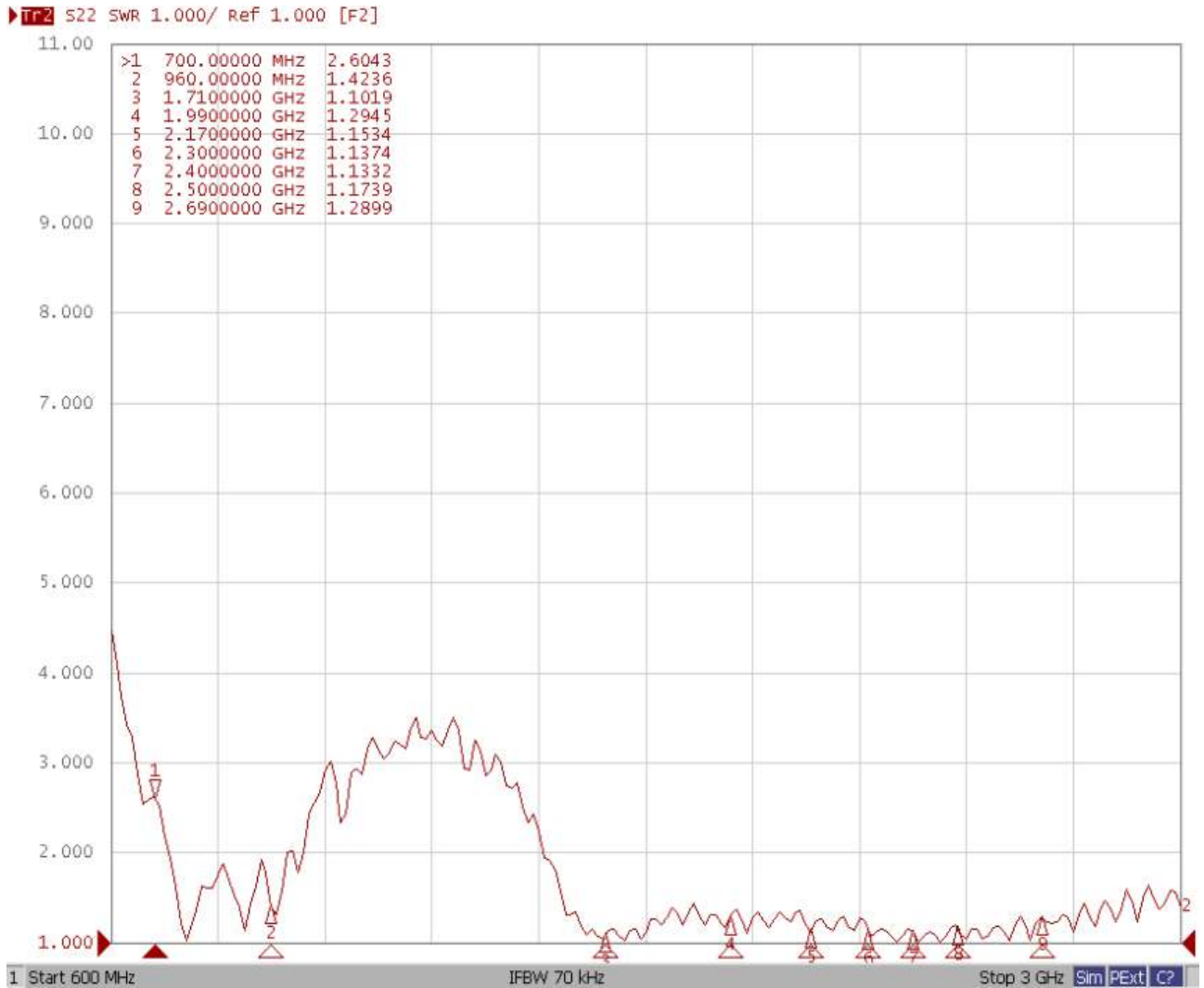

Frequency (MHz)	700	960	1710	2170	2300	2400	2500	2690
VSWR	2.60	1.42	1.10	1.15	1.13	1.13	1.17	1.28

4.2.2. LTE MIMO 2

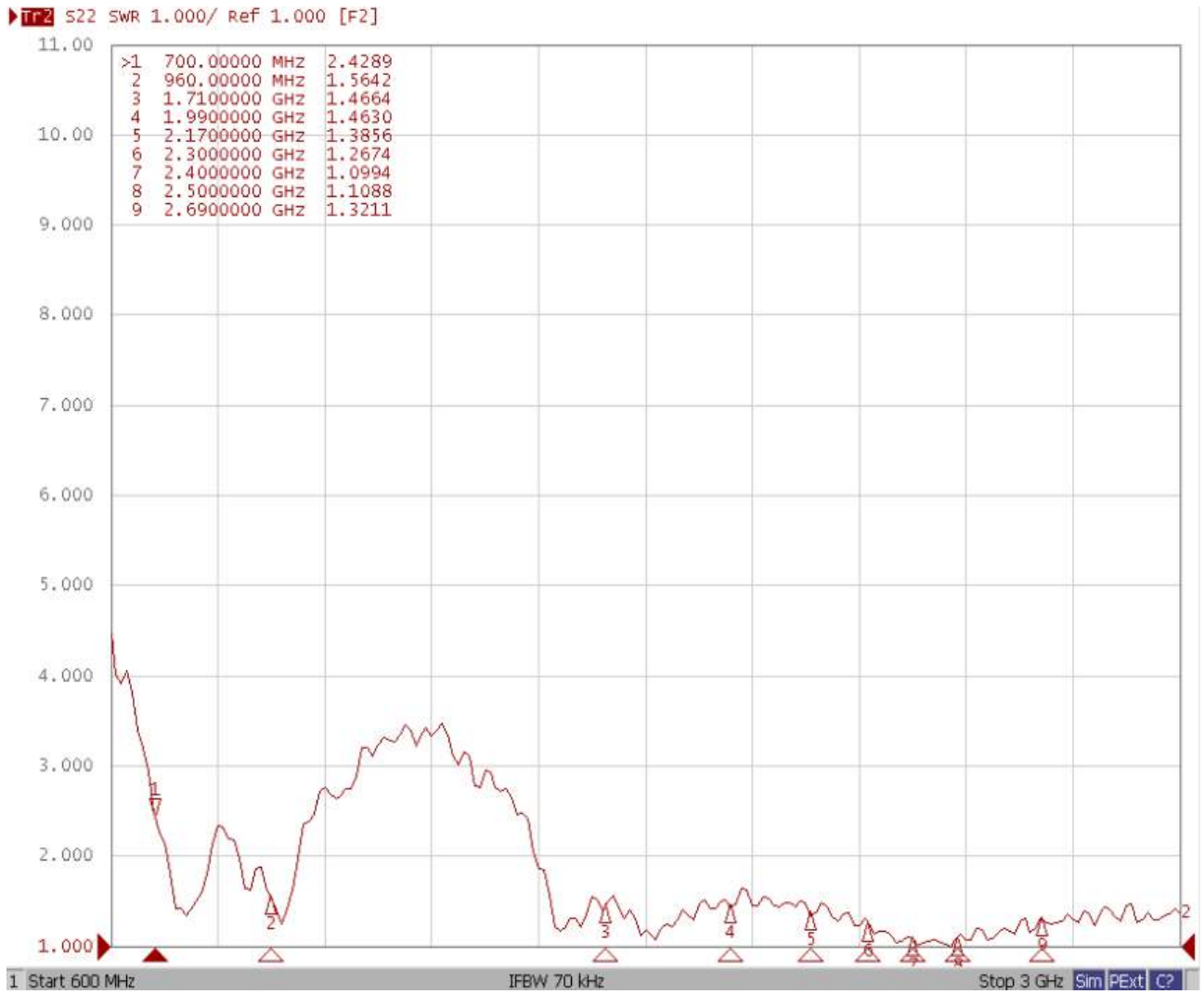

Frequency (MHz)	700	960	1710	2170	2300	2400	2500	2690
VSWR	2.42	1.56	1.46	1.38	1.26	1.09	1.10	1.32

4.3. Efficiency

4.3.1. LTE MIMO 1

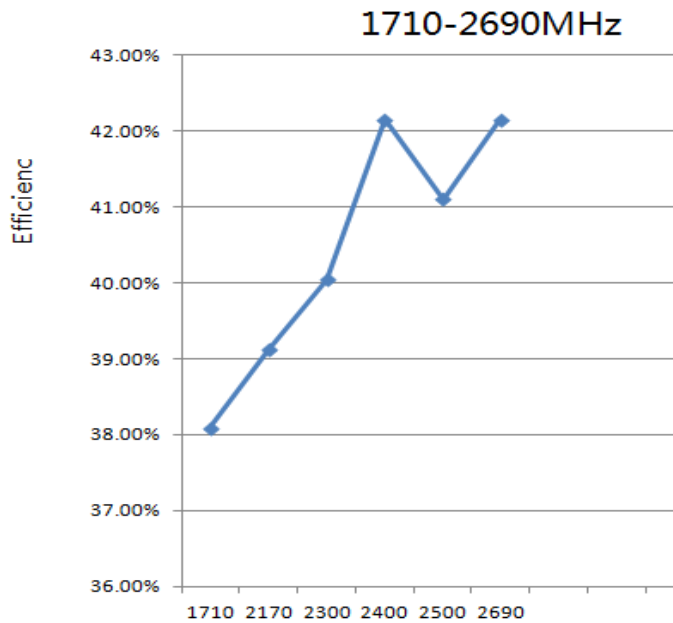
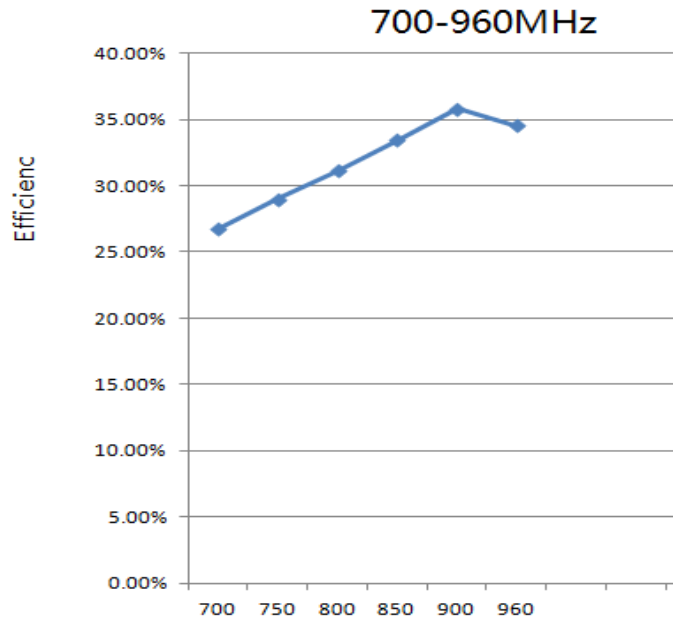

Frequency (MHz)	700	960	1710	2170	2300	2400	2500	2690
Efficiency (%)	26.73	34.54	38.09	39.12	40.04	42.15	41.10	42.15

4.3.2. LTE MIMO 2

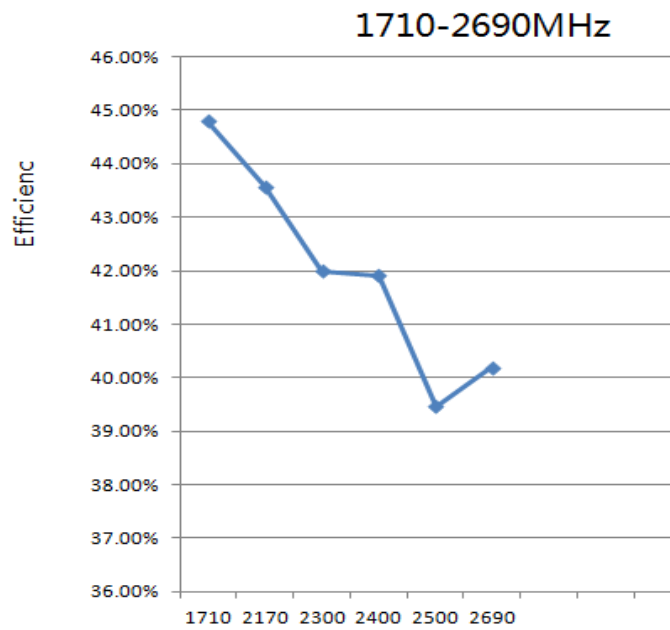
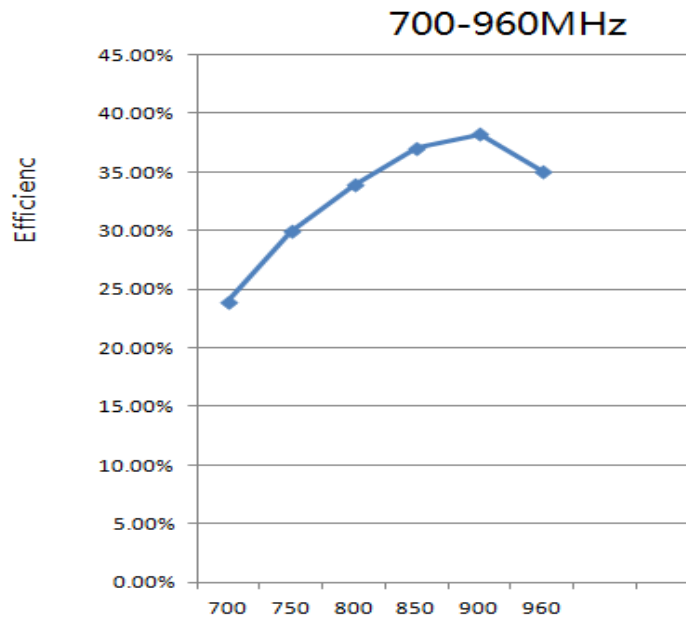

Frequency (MHz)	700	960	1710	2170	2300	2400	2500	2690
Efficiency (%)	24.32	35.12	44.79	43.57	41.99	41.91	39.46	40.19

4.4. Gain

4.4.1. LTE MIMO 1

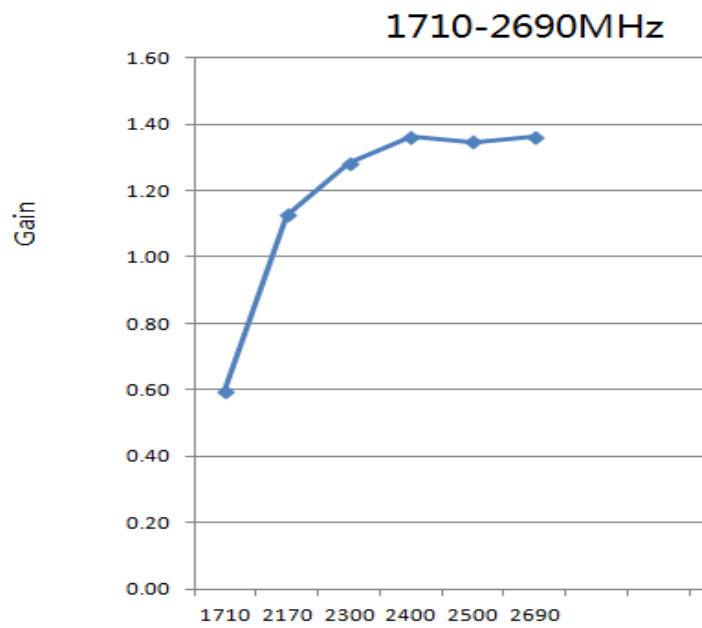
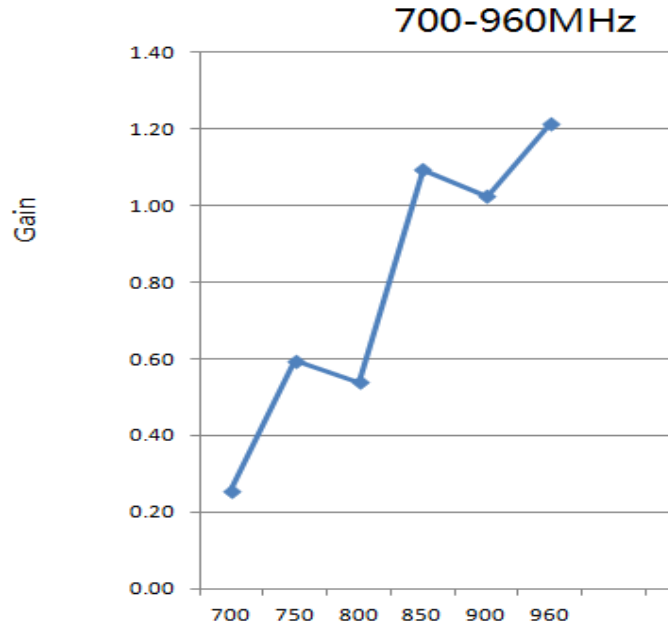

Frequency (MHz)	700	960	1710	2170	2300	2400	2500	2690
Gain (dBi)	0.26	1.21	0.60	1.13	1.28	1.36	1.35	1.36

4.4.2. LTE MIMO 2

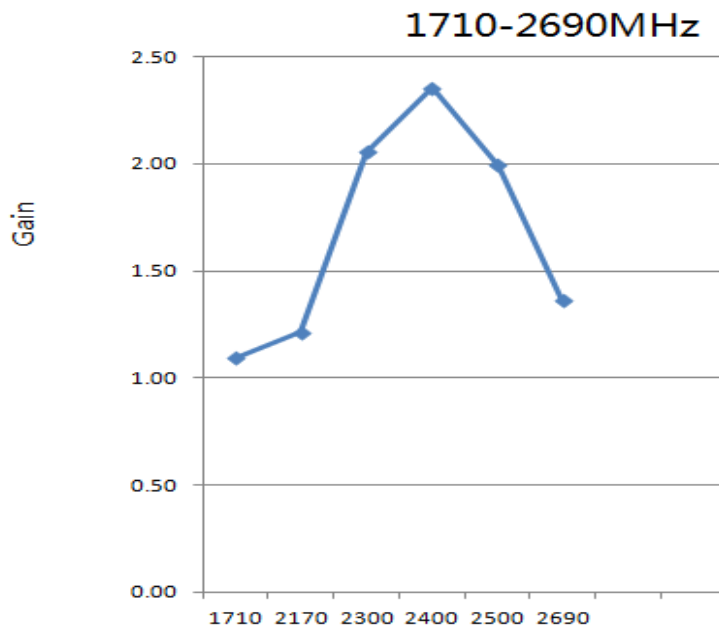
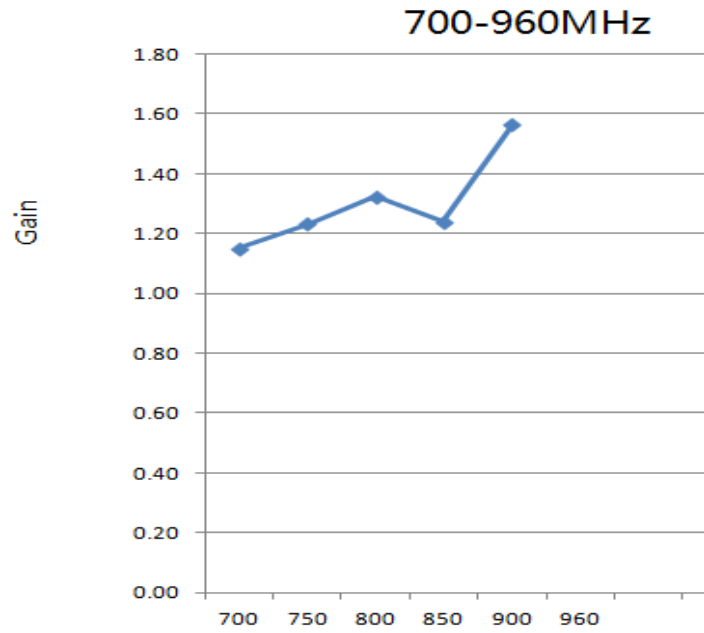

Frequency (MHz)	700	960	1710	2170	2300	2400	2500	2690
Gain (dBi)	0.82	1.56	1.09	1.21	2.05	2.36	1.99	1.36

4.5. Radiation Pattern

4.5.1. LTE MIMO 1

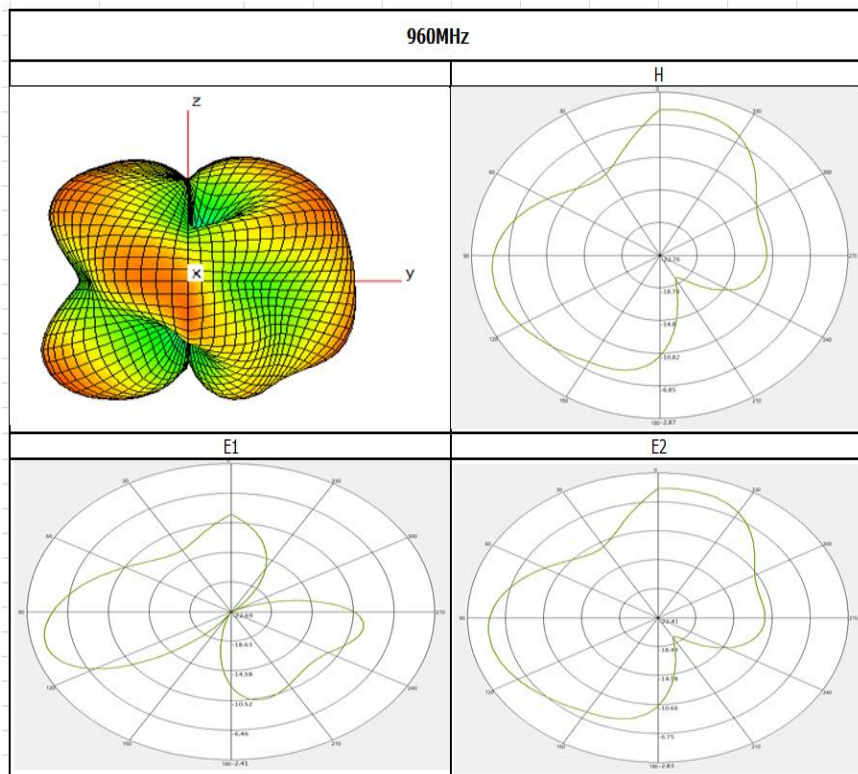
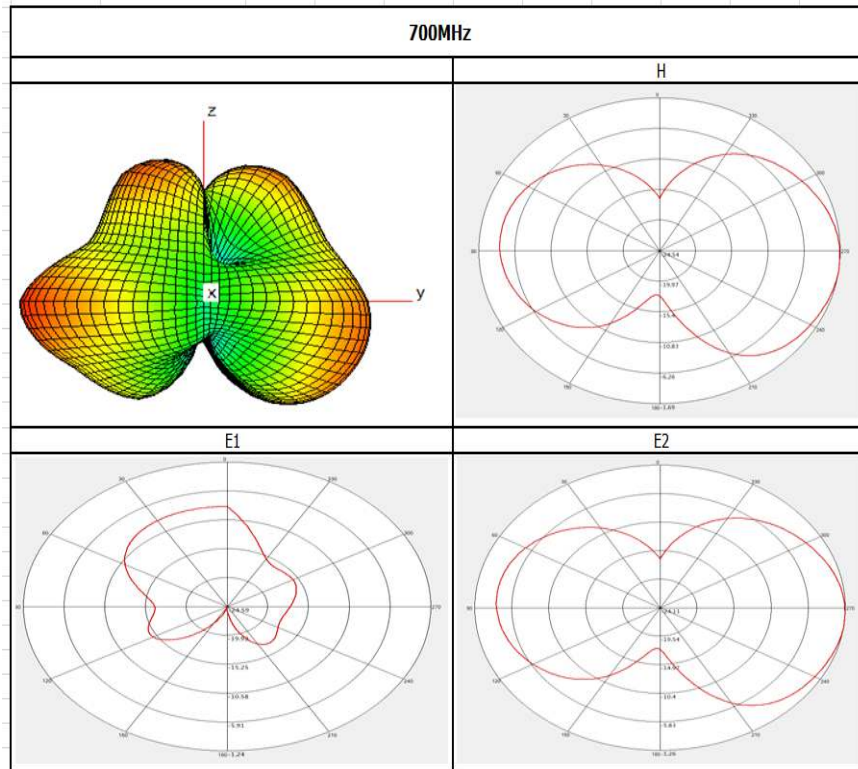

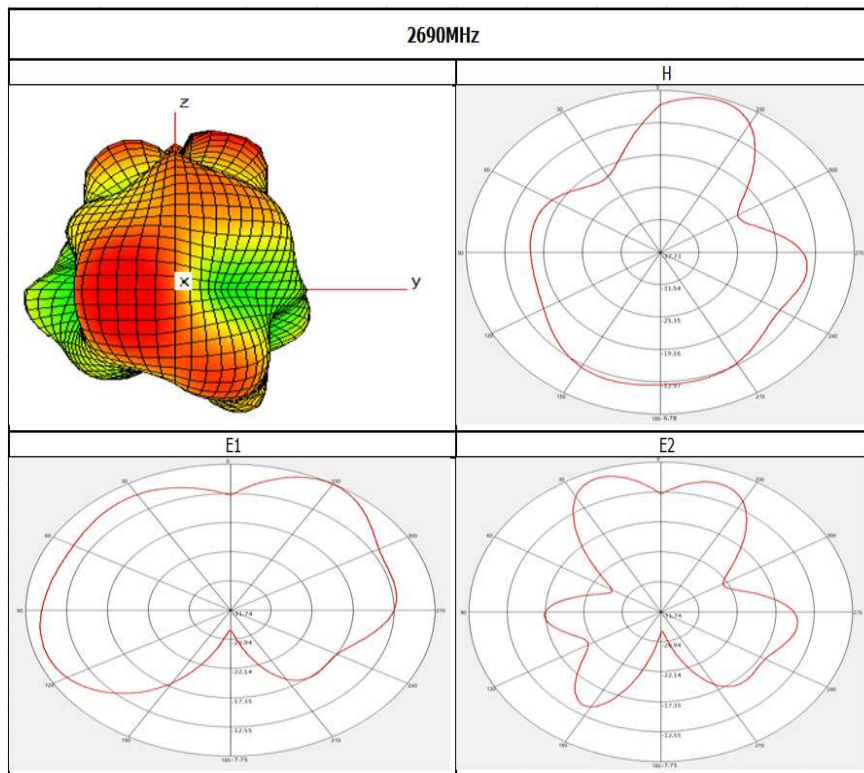
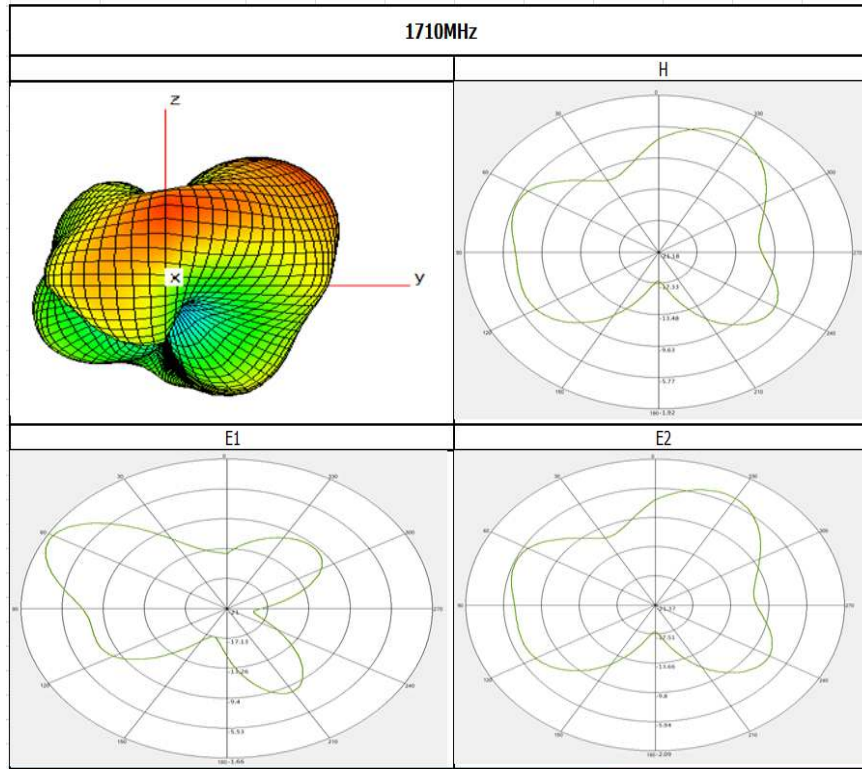

4.5.2. LTE MIMO 2

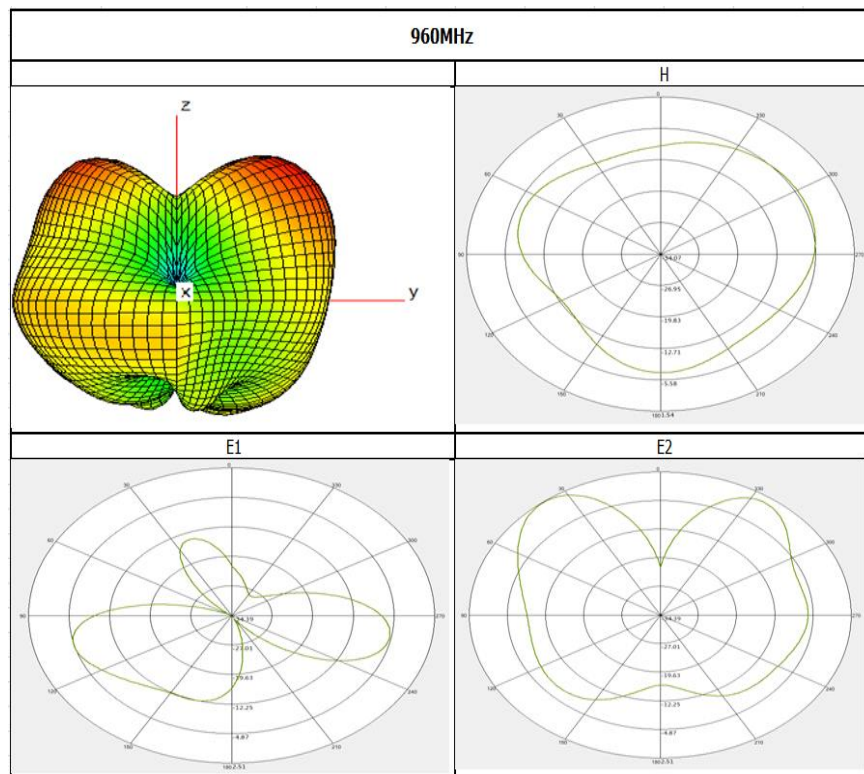
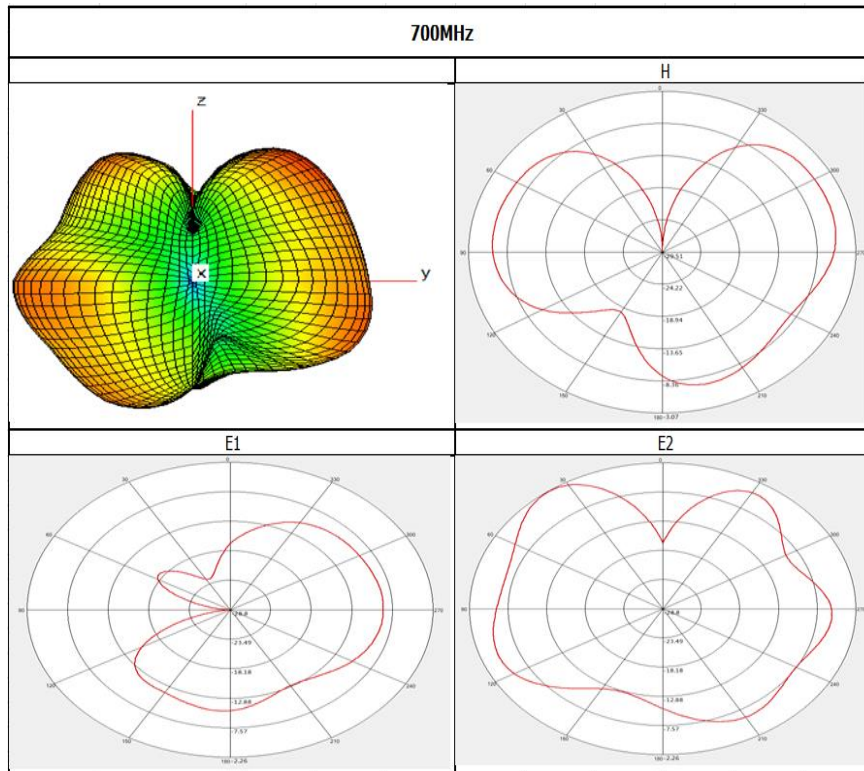

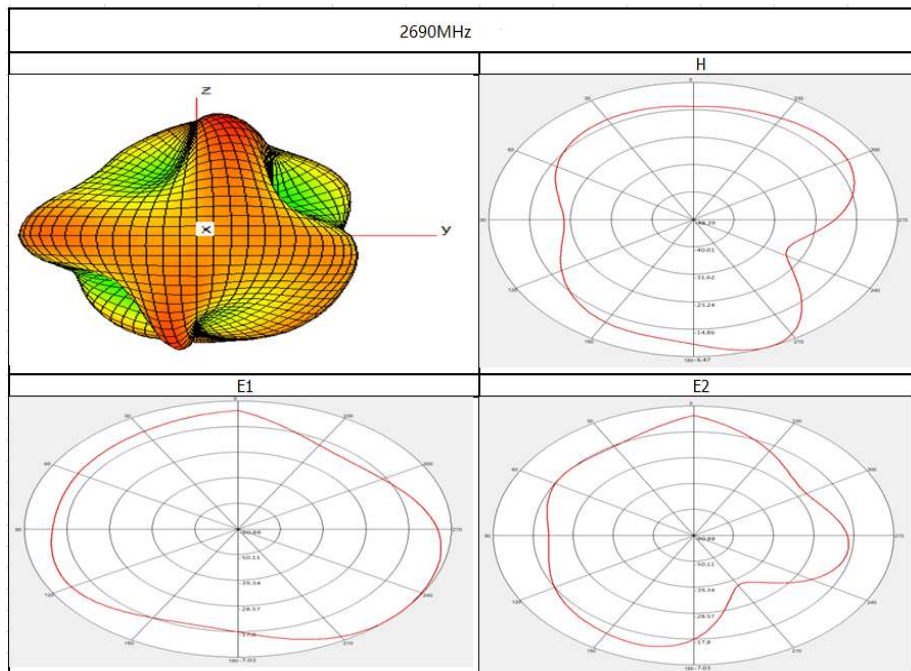
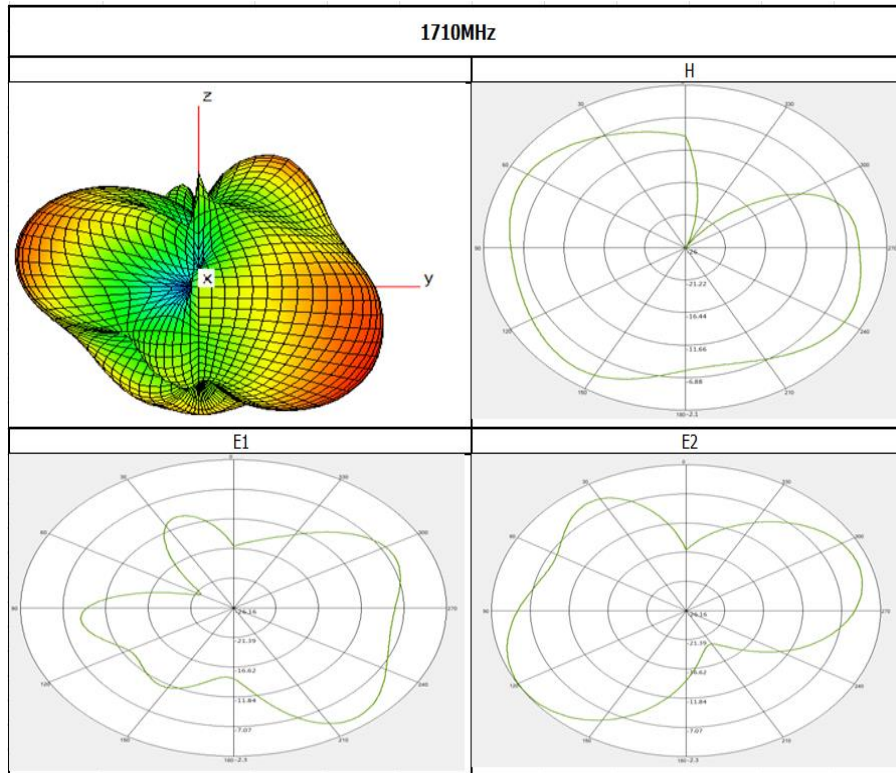

4.6. GNSS Antenna

- GPS L1 Antenna Gain (LNA)



GNSS Relative Gain Test Data

MARKER	Frequency/MHz	Gain/dB	SWR/S11
1	1559	22.2	1.86
2	1580	22.2	1.67
3	1610	21.4	1.59

- GPS L1 Antenna Measurement (Static State)

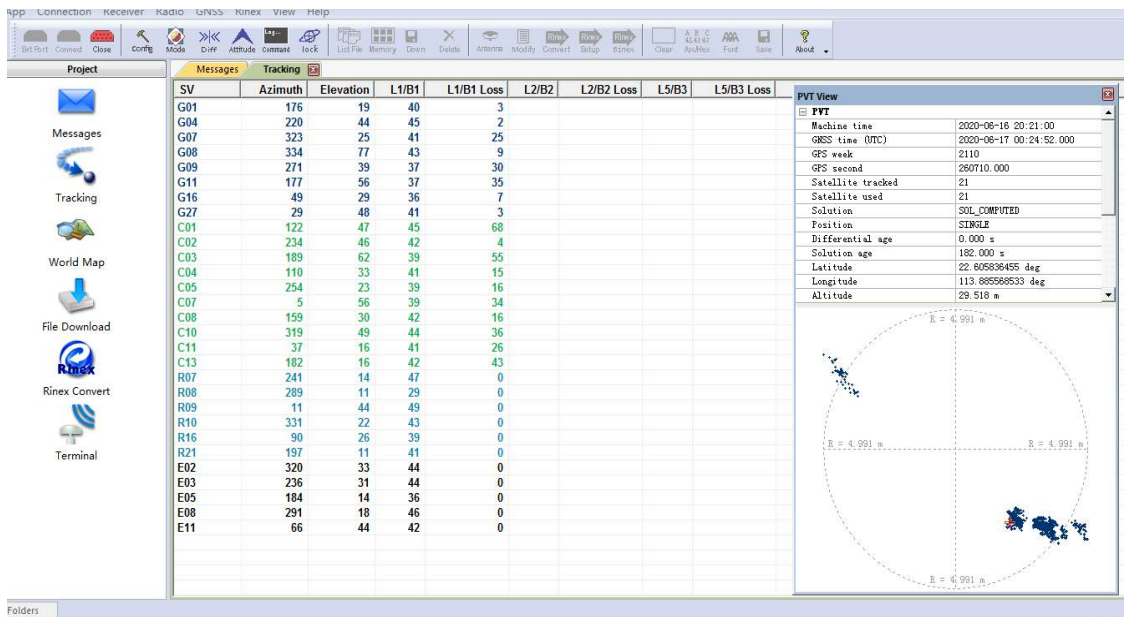

Test Condition: Outdoor; Roof of Fourth Floor; Sunny Day.

- GPS L1 Antenna Noise Figure (LNA)

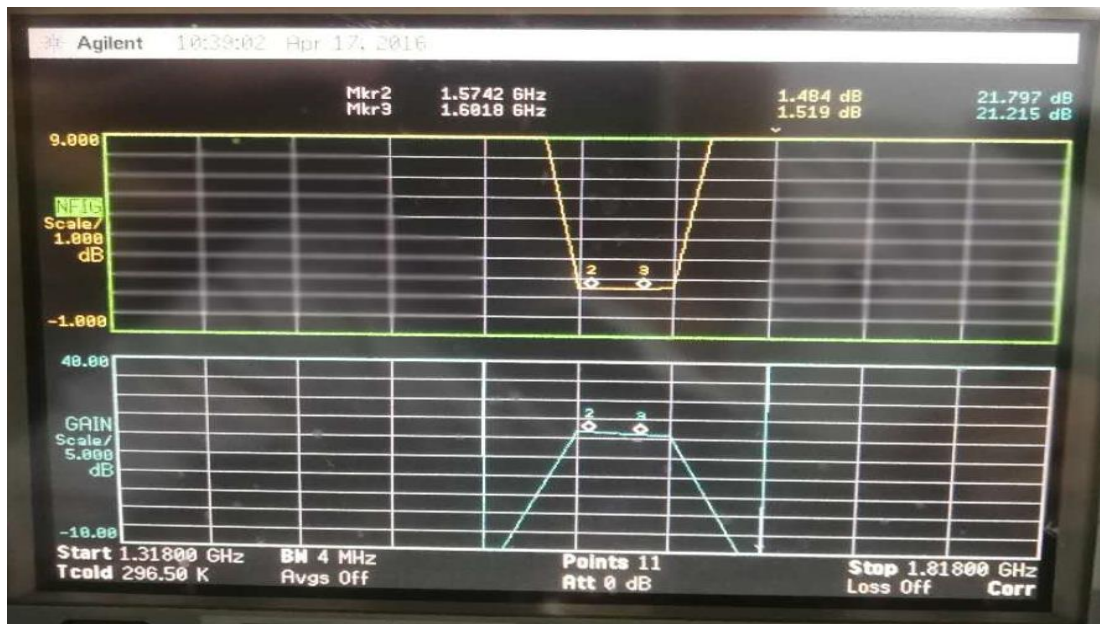

GPS Noise Test Data

MARKER	Frequency/MHz	Noise Factor/dB
1	1575	1.48
2	1601	1.51

4.7. Insulation

- LTE MIMO 1 & LTE MIMO 2

▶ Tr2 S12 Log Mag 10.00dB/ Ref 0.000dB [F2]

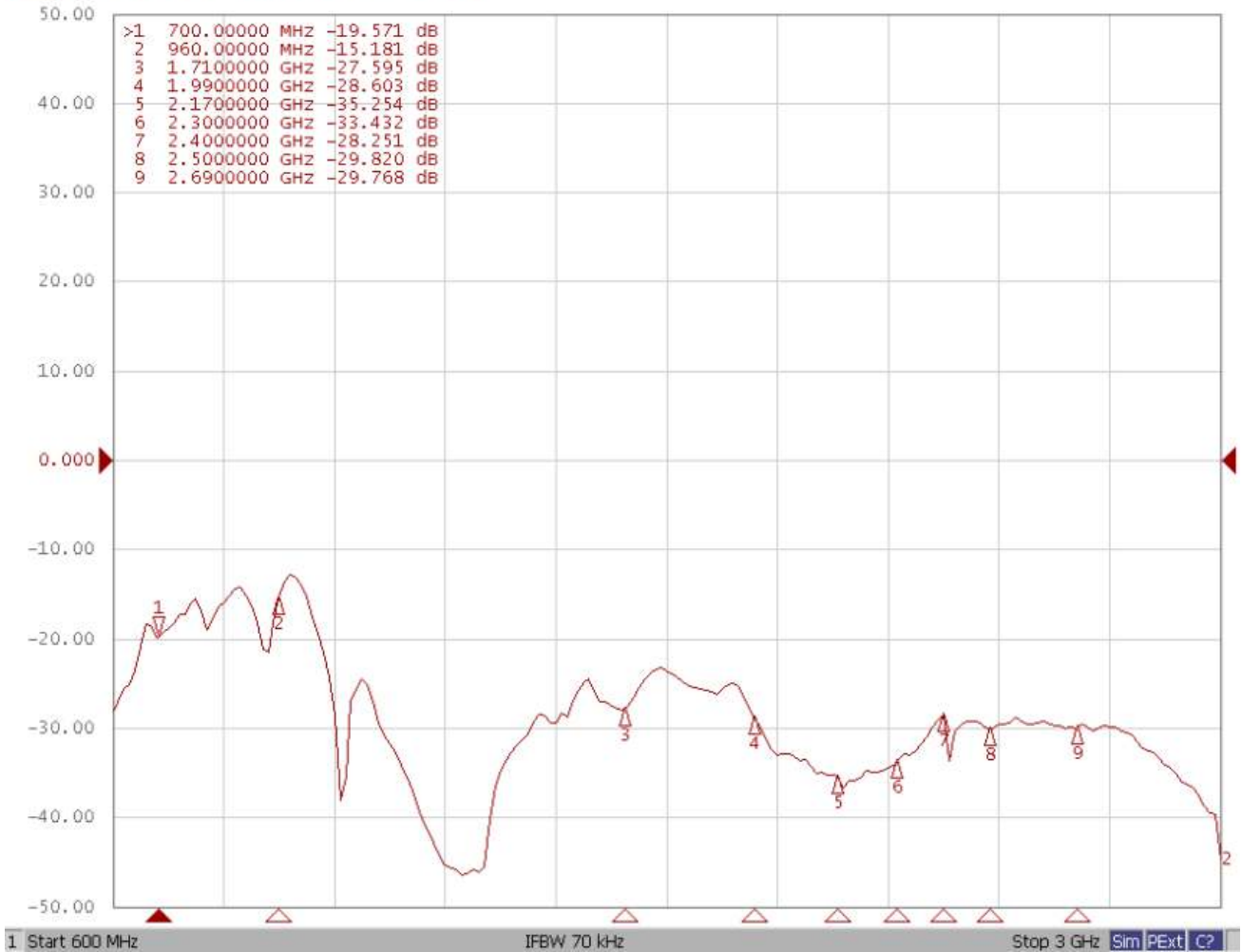

5 Product Size

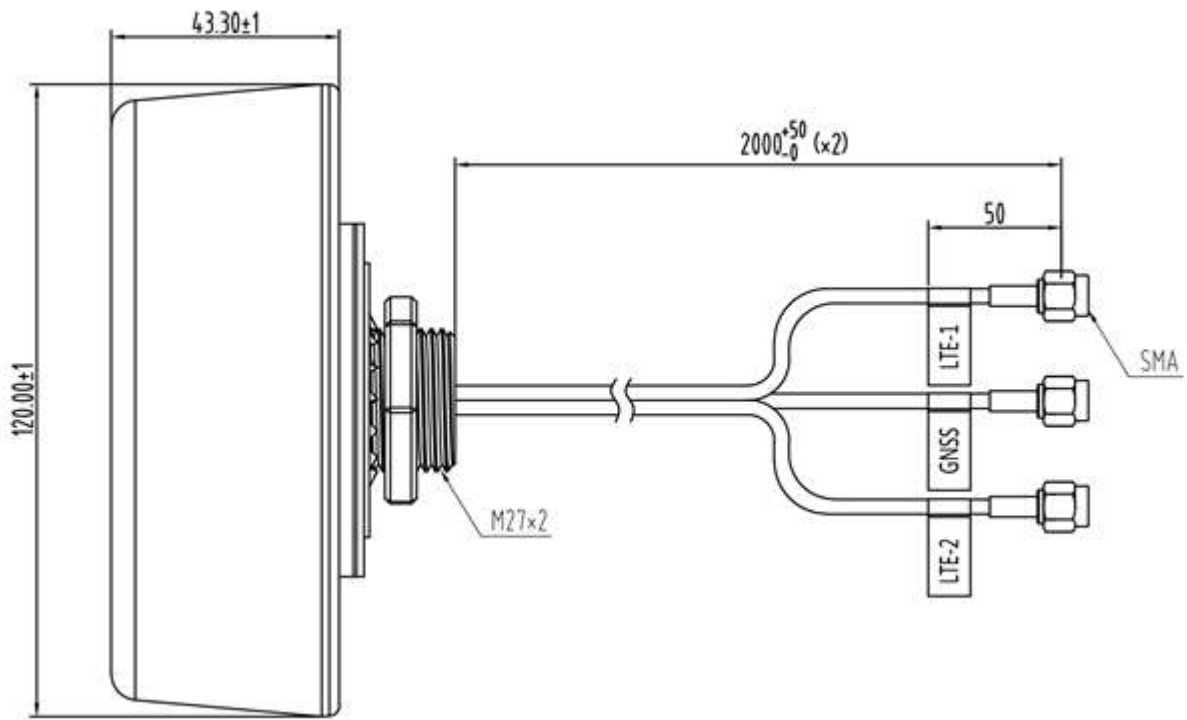

6 Connect Description

As follows, the default SMA male (center pin) is usually the setting that most users probably choose.



7 Installation

- Recommended hole size: $\Phi 28.0 \pm 0.5$ mm;
- Recommended wall thickness size: 3.0 ± 1.0 mm.

