



PART NAME

6" FLANGE KIT

PART No.

DPX-624KIT

REVISION DATE

2/22/21

NOTES:

- 1. MATERIAL: POLYCARBONATE.
- 2. QTY PER KIT - 2
- 3. FITS: DPH-28707 & DPS-28707
- 4. SUPPLIED WITH DPX-103275X (X 4#10-32 X 3/4" LONG, PAN HEAD, EACH PHILLIPS, SS FOR DPH/S SERIES)

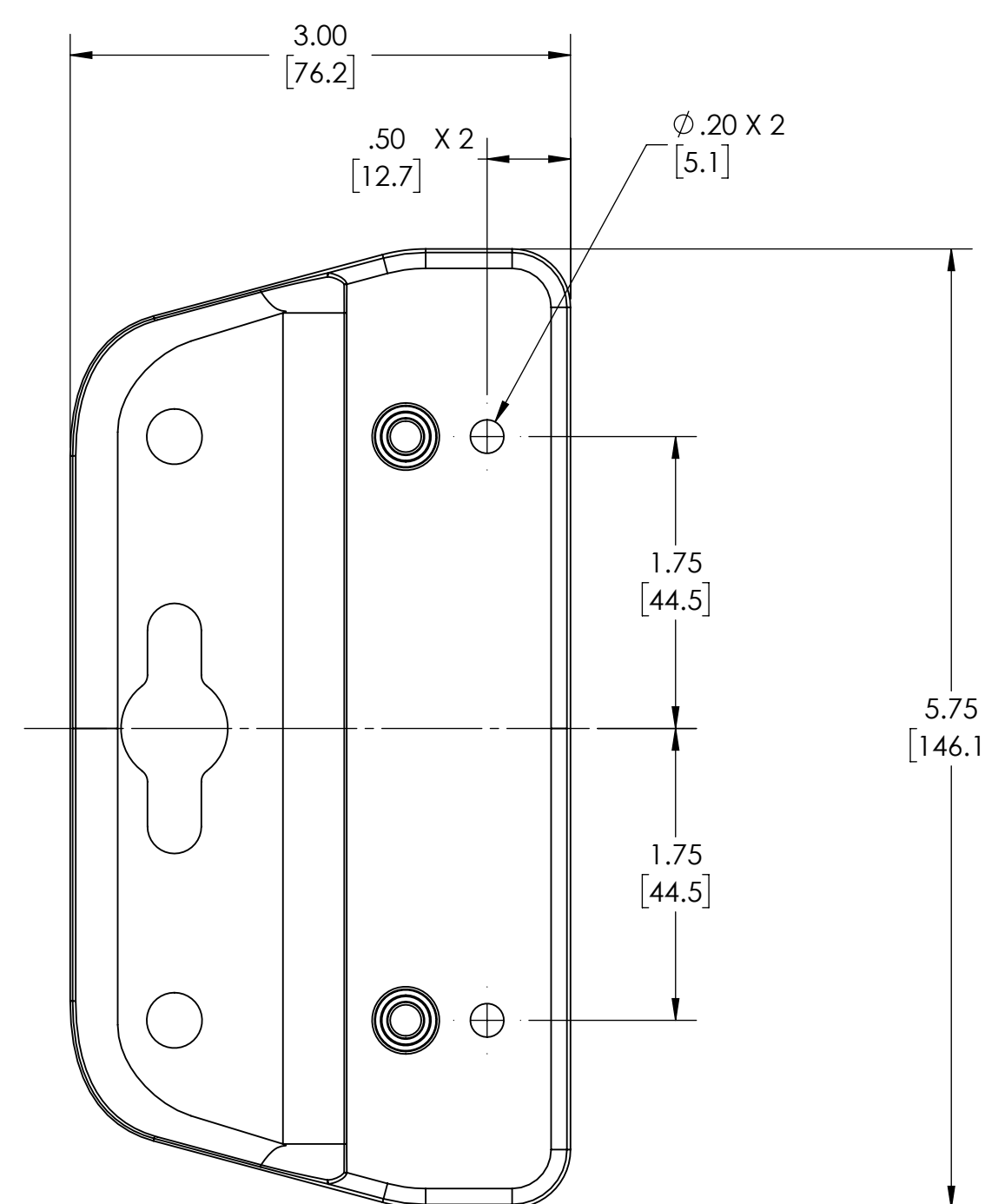
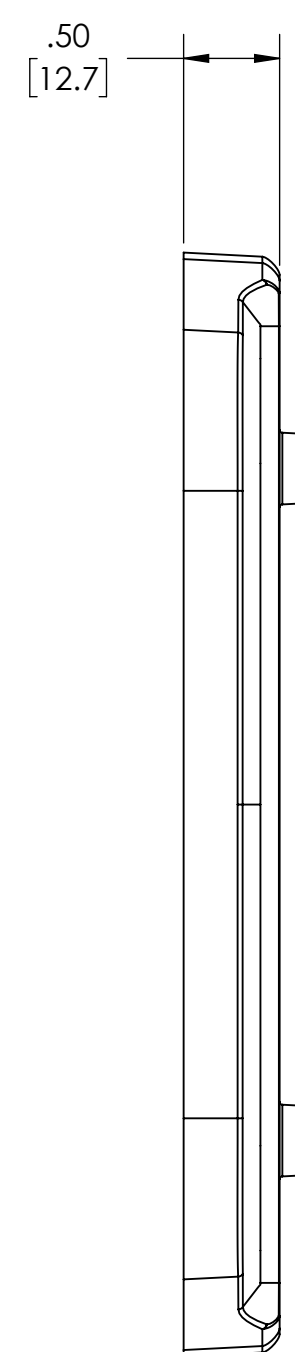
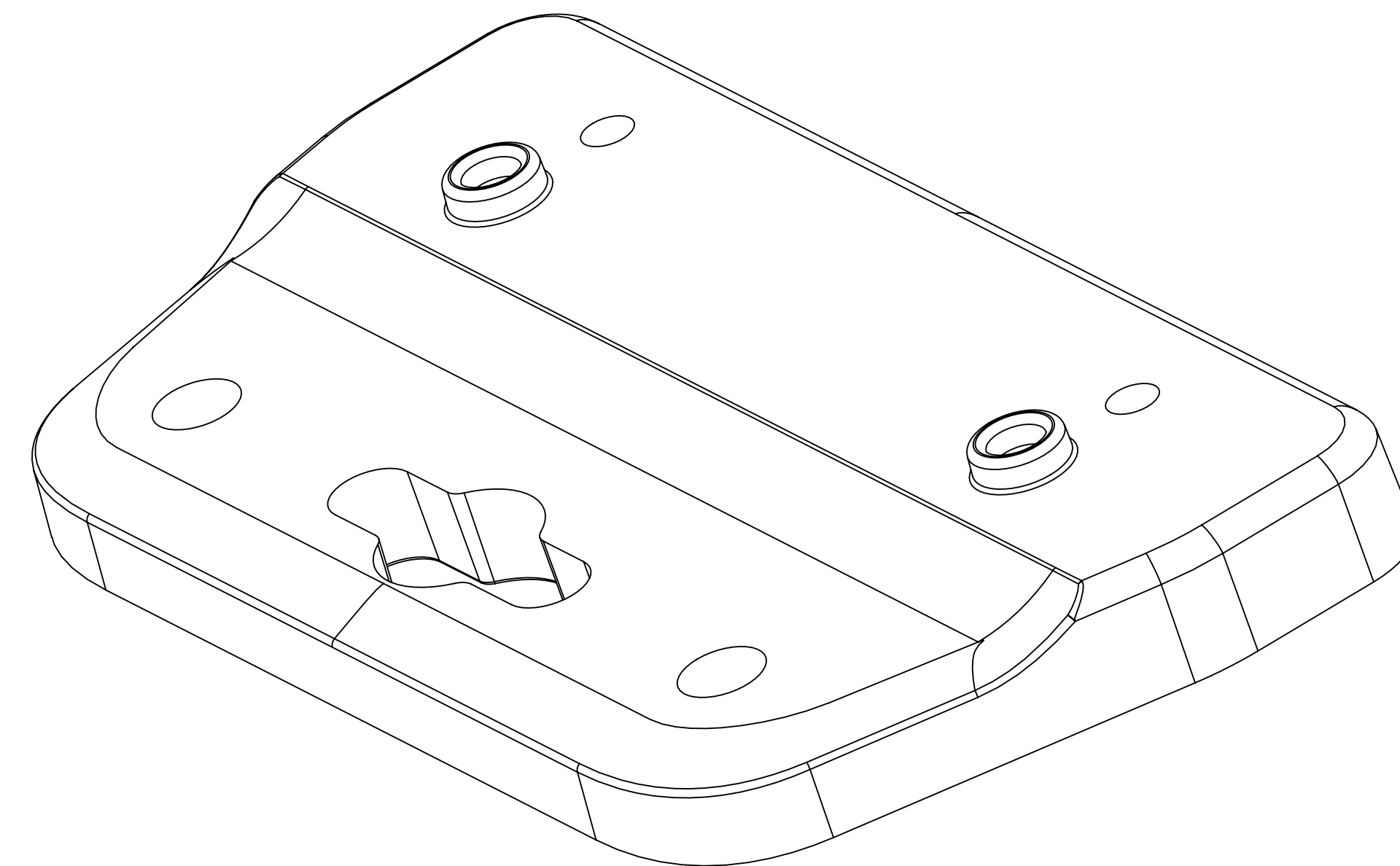

DRAWING FOR REFERENCE

WE RESERVE THE RIGHT TO MAKE CHANGES TO OUR STANDARD PRODUCTS. PLEASE CONSULT WITH BUD INDUSTRIES PRIOR TO USING THIS DRAWING FOR DESIGN PURPOSE.