

Technical Datasheet

ABCU-5741ARZ-C

Avago Broadcom® Compatible 10/100/1000Base-T SFP Transceiver

Hot Pluggable, 1.25Gb/s, Cat-5 UTP Cable, up to 100m, Industrial Temperature

FEATURES

- Up to 1.25Gb/s bi-directional data links
- Hot-pluggable SFP footprint
- Supports Links up to 100m using Cat-5 UPT Cable
- Fully metallic enclosure for low EMI
- Low power dissipation
- Compact RJ-45 connector assembly
- Detailed product information in EEPROM
- +3.3V single power supply
- Industrial Operating Temperature Range: -40 to 85°C
- Access to physical layer IC via 2-wire serial bus
- 10/100/1000 BASE-T operation in host systems with SGMII interface
- Compliant with SFP MSA
- Compliant with IEEE Std 802.3TM-2002
- Compliant with FCC 47 CFR Part 15, Class B
- RoHS Compliant Products

APPLICATIONS

- 1.25 Gigabit Ethernet over Cat 5 cable
- Switch/Router to Switch/Router Link
- High speed I/O for file servers

DESCRIPTION

ATGBICS® Compatible ABCU-5741ARZ-C 10/100/1000BASE-T copper SFP transceiver is high-performance, cost-effective module compliant with the Gigabit Ethernet and 10/100/1000BASE-T standards as specified in IEEE 802.3-2002 and IEEE 802.3ab, which supporting 10/100/1000Mb/s data-rate up to 100 meters reach over unshielded twisted-pair category 5 cable. The ABCU-5741ARZ-C supports 10/100/1000 Mb/s full duplex datalinks with 5-level Pulse Amplitude Modulation (PAM) signals. All four pairs in the cable are used with symbol rate at 250Mbps on each pair. The ABCU-5741ARZ-C provides standard serial ID information compliant with SFP MSA, which can be accessed with address of A0h via the 2-wire serial CMOS EEPROM protocol. The physical IC can also be accessed via 2-wire serial bus at address ACh.

Technical Datasheet

SFP TO HOST CONNECTOR PIN OUT

Pin	Signal name	Description	MSA Notes
1	VEET	Transmitter ground (common with receiver ground)	
2	TFAULT	Transmitter Fault. Not supported	Note 1
3	TDIS	Transmitter Disable. PHY disabled on high or open	Note 2
4	MOD_DEF(2)	Module Definition 2. Data line for Serial ID.	Note 3
5	MOD_DEF(1)	Module Definition 1. Clock line for Serial ID.	Note 3
6	MOD_DEF(0)	Module Definition 0. Grounded within the module.	Note 3
7	Rate Select	No connection required	
8	LOS	Loss of Signal - High Indicates Loss of Signal	Note 4
9	VEER	Receiver Ground (common with transmitter ground)	
10	VEER	Receiver Ground (common with transmitter ground)	
11	VEER	Receiver Ground (common with transmitter ground)	
12	RD-	Receiver Inverted DATA out. AC Coupled	Note 5
13	RD+	Receiver Non-inverted DATA out. AC Coupled	Note 5
14	VEER	Receiver Ground (common with transmitter ground)	
15	VCCR	Receiver Power Supply	Note 6
16	VCCT	Transmitter Power Supply	Note 6
17	VEET	Transmitter Ground (Common with Receiver Ground)	
18	TD+	Transmitter Non-Inverted DATA in. AC Coupled.	Note 7
19	TD-	Transmitter Inverted DATA in. AC Coupled.	Note 7
20	VEET	Transmitter Ground (common with receiver ground)	

Table 1. SFP to host connector pin assignments and descriptions

Notes:

- TX Fault is not used and is always tied to ground through a 100 Ohm resistor.
- TX Disable as described in the MSA is not applicable to the 1000BASE-T module, but is used for convenience as an input to reset the internal ASIC. This pin is pulled up within the module with a 4.7kΩ resistor.
Low (0 – 0.8V): Transceiver on
Between (0.8V and 2.0V): Undefined
High (2.0 – 3.465V): Transceiver in reset state
Open: Transceiver in reset state
- Mod-Def 0,1,2. These are the module definition pins. They should be pulled up with a 4.7-10kΩ resistor on the host board to a supply less than VCCT +0.3V or VCCR +0.3V.
Mod Def 0 is tied to ground through a 100-ohm resistor to indicate that the module is present.
Mod-Def 1 is clock line of two wire serial interface for optional serial ID
Mod-Def 2 is data line of two wire serial interface for optional serial ID
- LVTTL compatible with a maximum voltage of 2.5V. Not supported on HTSFP-24-111X

Technical Datasheet

- 5. RD±: These are the differential receiver outputs. They are ac coupled 100 Ohm differential lines which should be terminated with 100 Ohm differential at the user SerDes. The ac coupling is done inside the module and is thus not required on the host board. The voltage swing on these lines will be between 370 and 2000mV differential (185 – 1000mV single ended) when properly terminated. These levels are compatible with CML and LVPECL voltage swings.
- 6. VCCR and VCCT are the receiver and transmitter power supplies. They are defined as 3.3V ± 5% at the SFP connector pin. The maximum supply current is about 300mA, and the associated in-rush current will typically be no more than 30mA above steady state after 500 nanoseconds.
- 7. TD±: These are the differential transmitter inputs. They are ac coupled differential lines with 100W differential termination inside the module. The ac coupling is done inside the module and is thus not required on the host board. The inputs will accept differential swings of 500 – 2400mV (250 – 1200mV single ended), though it is recommended that values between 500 and 1200mV differential (250 – 600mV single ended) be used for best EMI performance. These levels are compatible with CML and LVPECL voltage swings.

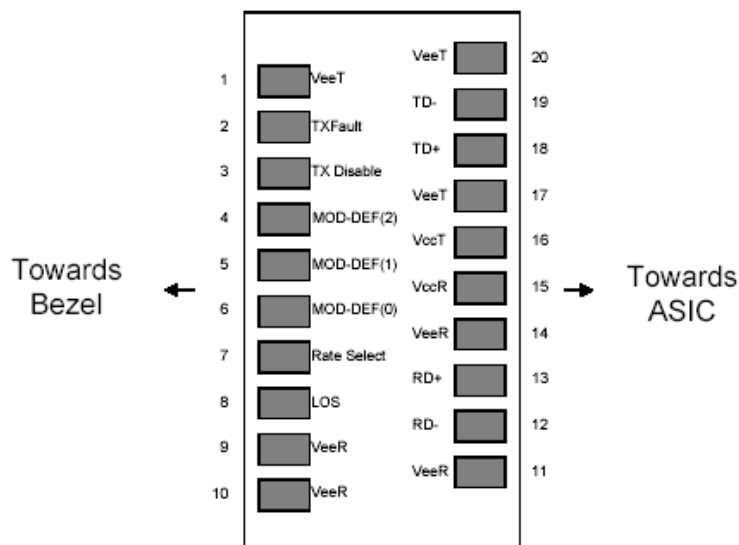

Figure 1. Diagram of host board connector block pin numbers and names

Technical Datasheet

+3.3V VOLT ELECTRICAL POWER INTERFACE

The ABCU-5741ARZ-C has an input voltage range of 3.3V ±5%. The 4V maximum voltage is not allowed for continuous operation.

Parameter	Symbol	Min.	Typical	Max.	Units	Notes/Conditions
Supply Current	Is		320	375	mA	1.2W max power over full range of voltage and temperature. See caution note below
Input Voltage	Vcc	3.13	3.3	3.47	V	Referenced to GND
Surge Current	Isurge		30		mA	Hot plug above steady state current. See caution note

Caution: Power consumption and surge current are higher than the specified values in the SFP MSA

Table 2. +3.3 Volt electrical power interface

LOW-SPEED SIGNALS

MOD_DEF(1) (SCL) and MOD_DEF(2) (SDA), are open drain CMOS signals. Both MOD_DEF(1) and MOD_DEF(2) must be pulled up to host_Vcc.

Parameter	Symbol	Min.	Max.	Units	Notes/Conditions
SFP Output LOW	VOL	0	0.5	V	4.7k to 10k pull-up to host_Vcc.
SFP Output HIGH	VOH	host_Vcc - 0.5	host_Vcc +0.3	V	4.7k to 10k pull-up to host_Vcc.
SFP Input LOW	VIL	0	0.8	V	4.7k to 10k pull-up to Vcc.
SFP Input HIGH		2	Vcc +0.3 V	V	4.7k to 10k pull-up to Vcc.

Table 3. Low-Speed Signals

HIGH-SPEED ELECTRICAL INTERFACE

Transmission Line-SFP						
Parameter	Symbol	Min.	Typical	Max.	Units	Notes/Conditions
Line Frequency	fL		125		MHz	5-level encoding, per IEEE 802.3
Tx Output Impedance	Zout,TX		100		Ohm	Differential
Rx Input Impedance	Zin,RX		100		Ohm	Differential

Table 4. High-speed electrical interface, transmission line-SFP

Technical Datasheet

Host-SFP						
Parameter	Symbol	Min.	Typical	Max.	Units	Notes/Conditions
Single ended data input swing	Vinsing	250		1200	mV	Single ended
Single ended data output swing	Voutsing	350	100	800	mV	Single ended
Rise/Fall Time	Tr,Tf		175		psec	20%-80%
Tx Input Impedance	Zin		50		Ohm	Single ended
Rx Output Impedance	Zout		50		Ohm	Single ended

Table 5. High-speed electrical interface, host-SFP

GENERAL SPECIFICATIONS

Parameter	Symbol	Min.	Typical	Max.	Units	Notes/Conditions
Data Rate	BR	10		1,000	Mb/s	IEEE 802.3 compatible.
Cable Length	L			100	m	Category 5 UTP. BER <10-12

Table 6. General specifications

Notes:

1. Clock tolerance is ± 50 ppm
2. By default, the ABCU-5741ARZ-C is a full duplex device in preferred master mode
3. Automatic crossover detection is enabled. External crossover cable is not required
4. 10/100/1000 BASE-T operation requires the host system to have an SGMII interface with no clocks, with a SERDES that does not support SGMII, the module will operate at 1000BASE-T only.

ENVIRONMENTAL SPECIFICATIONS

The ABCU-5741ARZ-C has an Industrial range from -40°C to +85°C case temperature as specified below.

Parameter	Symbol	Min.	Typical	Max.	Units	Notes/Conditions
Operating Temperature	Top	-40		85	°C	Case temperature
Storage Temperature	Tsto	-40		85	°C	Ambient temperature

Technical Datasheet

SERIAL ID MEMORY CONTENTS:

Data Address	Length (Byte)	Name of Length	Description and Contents
Base ID Fields			
0	1	Identifier	Type of Serial transceiver (03h=SFP)
1	1	Reserved	Extended identifier of type serial transceiver (04h)
2	1	Connector	Code of optical connector type (22=RJ45)
3-10	8	Transceiver	10/100/1000BASE-T
11	1	Encoding	8B10B (01h)
12	1	BR,Nominal	Nominal baud rate, unit of 100Mbps
13	1	Reserved	(0000h)
14	1	Length(9um,km)	Link length supported for 9/125um fiber, units of km
15	1	Length(9um)	Link length supported for 9/125um fiber, units of 100m
16	1	Length(50um)	Link length supported for 50/125um fiber, units of 10m
17	1	Length(62.5um)	Link length supported for 62.5/125um fiber, units of 10m
18	1	Length(Copper)	Link length supported for copper, units of meters
19	1	Reserved	
20-35	16	Vendor Name	SFP vendor name: ATGBICS
36	1	Reserved	
37-39	3	Vendor OUI	SFP transceiver vendor OUI ID
40-55	16	Vendor PN	Part Number: "ABCU-5741ARZ-C" (ASCII)
56-59	4	Vendor rev	Revision level for part number
60-61	2	Wavelength	Laser wavelength
62	1	Reserved	
63	1	CCID	Least significant byte of sum of data in address 0-62
Extended ID Fields			
64-65	2	Option	Indicates which optical SFP signals are implemented(001Ah = LOS, TX_FAULT, TX_DISABLE all supported)
66	1	BR, max	Upper bit rate margin, units of %
67	1	BR, min	Lower bit rate margin, units of %
68-83	16	Vendor SN	Serial number (ASCII)
84-91	8	Date code	Manufacturing date code
92-94	3	Reserved	
95	1	CCEX	Check code for the extended ID Fields (addresses 64 to 94)
Vendor Specific ID Fields			
96-127	32	Readable	Vendor specific date, read only

Technical Datasheet

MECHANICAL SPECIFICATIONS (UNIT: mm)

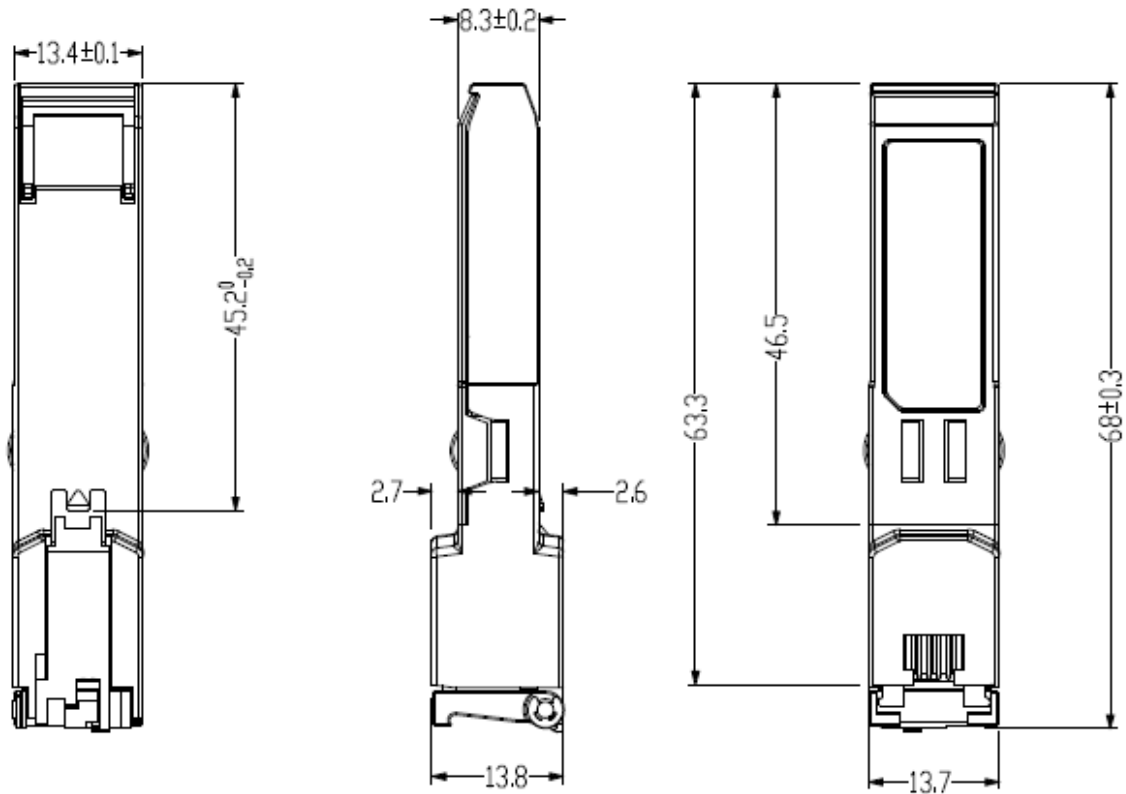

Figure 2. Mechanical Dimensions of Transceiver