

SL40.300/.301

- Input: 3 AC 400...500V
- Output: 24...28V / 960W (1080W)
- No switch-off at overload
- Ideal for parallel operation
- Output for measurement and logical signals (.301)

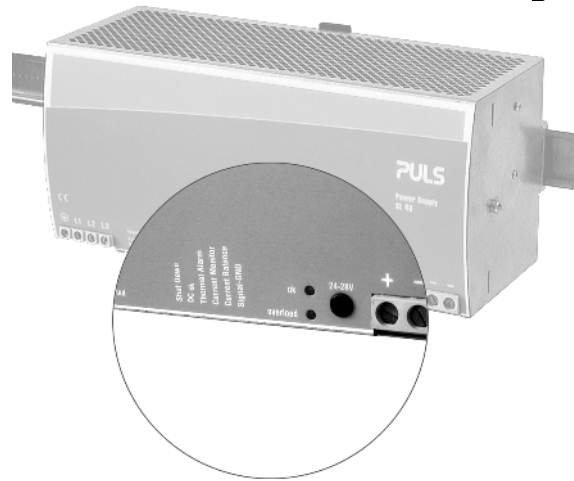

Input

Input voltage	3 AC 400...500 V, - 15 %, + 15 % 47-63 Hz, Suitable for IT power systems
Rated Tolerances	<ul style="list-style-type: none"> • Continuous operat. 340-575 V AC • Short term (1 min) 300-620 V AC at 24 V/40 A
Input current	3.0 A
Inrush current	< 30 A
Inrush current limiting done with a fixed 23R resistor (not a thermistor) which is bridged after the unit is running, so losses are minimized. That means no reset time even at a warm-start.	
Fuse loading	3 A ² s
To be fused with a 3 x 10A, B-type 'circuit-breaker' switch based on the usual thermomagnetic overload sensing principle (used anyway to fuse the input lines; unit has no internal fuses).	
Harmonic current emissions (PFC)	acc. EN 61000-3-2
Transient handling	Active transient filter incorporated, so transient resistance acc.to VDE 0160 / W2 (1300 V / 1.3 ms), for all load conditions.
Hold up time	min. 15 ms at 400 V AC, 24 V / 40 A

Construction / Mechanics *

Housing dimensions and Weight	<ul style="list-style-type: none"> • W x H x D 275 mm x 124 mm x 117 mm (+ DIN rail) • Free space for ventilation above/below each 70 mm recommended left/right each 25 mm recommended • Weight 3.3kg
Connections (input and output)	robust screw terminals, connector size range: <ul style="list-style-type: none"> • solid: 1.5...6 mm² (Outp.: 0.5...16 mm²) • flexible: 1.5...4 mm² (Outp.: 0.5...10 mm²) Output: Minus terminal with 2 connectors, current handling per output: 40 A (max. acc. to UL) resp. 56 A (max. acc. to VDE)
Design advantages:	<ul style="list-style-type: none"> • All connection blocks mounted on front panel for ease of access. • PVC insulated cable can be used for all connections, as the connection blocks are mounted in the cooler area on the underside of the unit. • Power density: 230 W per litre housing volume.

Output (signal outputs see overleaf)

Output voltage	24...28 V DC, adjustable by (covered) front panel potentiometer. Adj. range guaranteed
Output noise suppression	Radiated EMI values below EN 61000-6-3, even when using long, unscreened output cables.
Ambient temperature range T _{amb}	Operation: 0°C...+70°C (>60°C: Derating) Storage: -25°C...+85°C
Rated continuous loading with convection cooling	<ul style="list-style-type: none"> • T_{amb}=0°C - 60°C 24 V / 40 A (960 W) resp. 28 V / 35 A (980 W) • T_{amb}=0°C - 45°C 24 V / 45 A (1080 W) resp. 28 V / 38 A (1064 W) short-term (< 1 min.) also at 60°C admissible
Derating	typ. 24 W/K (at T _{amb} =+60°C...+70°C)
Voltage regulation	better than 2% over all
Ripple (incl. spikes)	< 50 mV _{pp} (20 MHz bandw., 50 Ω measur.)
Over-voltage protection At 32 V ± 10%: switch to hiccup mode	
Front panel indicators:	<ul style="list-style-type: none"> • Green LED on, when V_{out} > U_T, where U_T is ca. 2 V below V_{out} adjusted (24V...28V) • Red LED on, when V_{out} < U_T
Parallel operation	SL40.300: yes, no active current sharing SL40.301: yes, active current sharing, please refer to "Output Signaling" - "Current Balance"
Current sharing by balancing line (active sharing principle, SL40.301) or 'soft' output characteristic (passive sharing principle, SL40.300; characteristic switch-over by jumper as in SL20/SL30 without opening the unit)	
Power Back Immunity	< 35 V

Efficiency, Reliability etc. *

Efficiency	typ. 92.5% (400 VAC, 24 V / 40 A)
Losses	typ 78 W (400 VAC, 24 V / 40 A)
MTBF	SL40.300: 305,000 h SL40.301: 268,000 h acc. to Siemensnorm SN 29500 (24 V/40 A, 400 VAC, T _{amb} = +40 °C)
Life cycle (electrolytics)	The unit exclusively uses longlife electrolytics, specified for +105°C (cf. 'The SilverLine', p.2). High reliability and lifetime, as <ul style="list-style-type: none"> • only 6 aluminum electrolytics and • no small aluminum electrolytics are used.

Order information

Order number	Description
SL40.300	basic version, passive load sharing
SL40.301	with signal/measurement outputs, signal output connector included: Order number XFB-S-W8-MSTB 06-W8)
SLZ01	Screw mounting set, two needed per unit

Start / Overload Behaviour

Startup delay	< 0.5 s
Rise time	< 0.1 s (40 A, 20,000 F)
Overload behaviour	PULS Overload Design (see diagram at the right), thus neither switch-off nor hiccup at overload

Advantages:

- High short-circuit current, giving large 'start-up window': unit starts reliably even with awkward loads (DC-DC converters, motors). No 'sticking' as can occur with fold-back characteristics.
- Even longer overload possible as unit does not switch off.

Output for measurements and signalling

(SL40.301 only)

'Shut-Down': Shut-down input: units switches off, if

- Input is connected to 'Signal GND' ($\Delta U < 1V$) or
- +20...28 V Voltage are applied to this input and 'Signal GND' (max. 20 mA).

'Power Good': Power-Fail / -Good

- Signal: High (24 V) at correct operation (no overload, over-temp., short-circuit). At 'low' signal and nominal load, output remains at nominal voltage for at least 5 ms.
- Corresponding ground is 'Signal GND' output (current source)
- Permissible load resistance: $\geq 300 \Omega$, e.g. 24V relays, control lamp (no dropping resistor needed for LED), scoring logic. To get 5V level: connect this output and 'Signal GND' via 5V zener diode (0.5W) + 1k Ω resistor switched in parallel

'Thermal Alarm': warning signal at over-temperature

- Signal: High (24 V) at correct operation (no over-temperature). If signal switches to 'low' and temperature increases further, output current is lowered,
- Ground and permissible load resistance: see 'Power Good' output

'Current Monitor': Current measurement output, usable with

- Voltmeter 1 V per 10 A output current (to 'Signal GND' output, $R_{in}(\text{voltmeter}) > 100 \text{ k}\Omega$)
- Ammeter 1 mA per 10 A output current (to 'Signal GND' output, $R_{in}(\text{ammeter}) < 100 \Omega$)

'Current Balance': balancing output for current sharing

- For active current sharing at parallel operation interconnect the "Current Balance" output terminals of all paralleled units. The corresponding ground is the \ominus pole. Do not interconnect the "Signal GND" outputs. Exact output voltage regulation is effective when the output current is greater than 0.4A. Current sharing also works reliable with decoupling diodes and modules for redundancy applications.

'Signal GND': Ground terminal for all signal outputs of this unit (not 'Current Balance')

- Do not connect this terminal to the \oplus terminal of this unit (not even across a load: risk of overload)
- Do not connect this terminal to any output of another unit (not even with 'Signal GND' of another unit)
- max. load current: 0.3 A
- Signal ground is internally fused by a self-curing fuse (polyswitch)

Further Information

For further information, especially about EMC, Connections, Safety, Approvals, Mechanics und Mounting see page 2 of the „The SilverLine“ data sheet. For detailed dimensions please see the SilverLine mechanics data sheet SL40.

Output V/I characteristic (typ.)

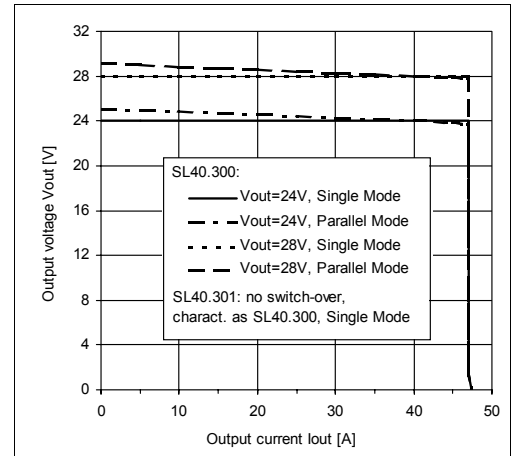

Efficiency (typ., at $V_{out}=24V$)

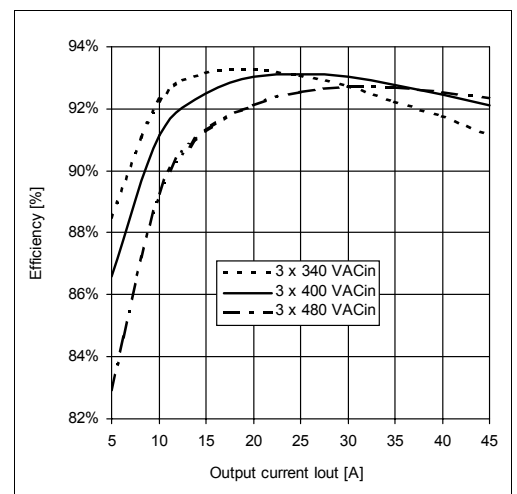

Hold-up time (min., at $V_{out}=24V$)

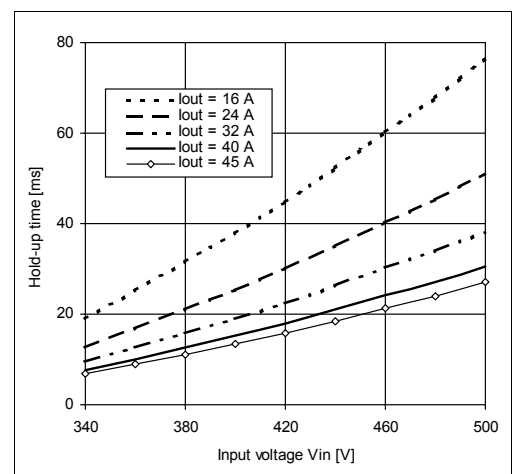

Specifications valid for 3 x AC 400V input voltage, +25°C ambient temperature, and 5 min run-in time, unless otherwise stated. They are subject to change without prior notice.

Your partner in power supply:



PULS GmbH
 Arabellastraße 15
 D-81925 München
 Tel.: +49 89 9278-0
 Fax: +49 89 9278-199
 www.puls-power.com

Mechanics

PULS

SL40

- Innovative DIN-Rail mount, unit holds even at vibration or lateral pressure
- Clearly arranged and user oriented
- Large, robust screw terminals
- Sealed metal housing
- Fine ventilating grid

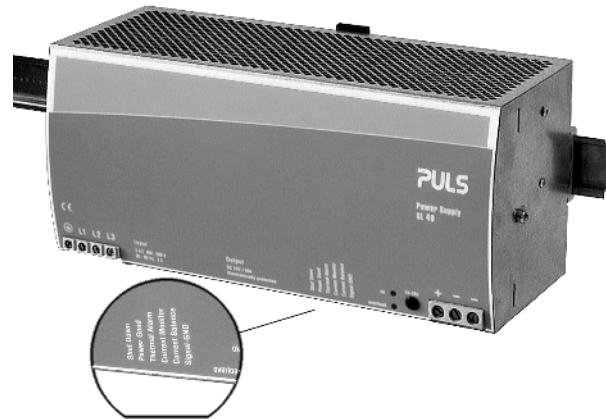

Front view SL40.300/ .301

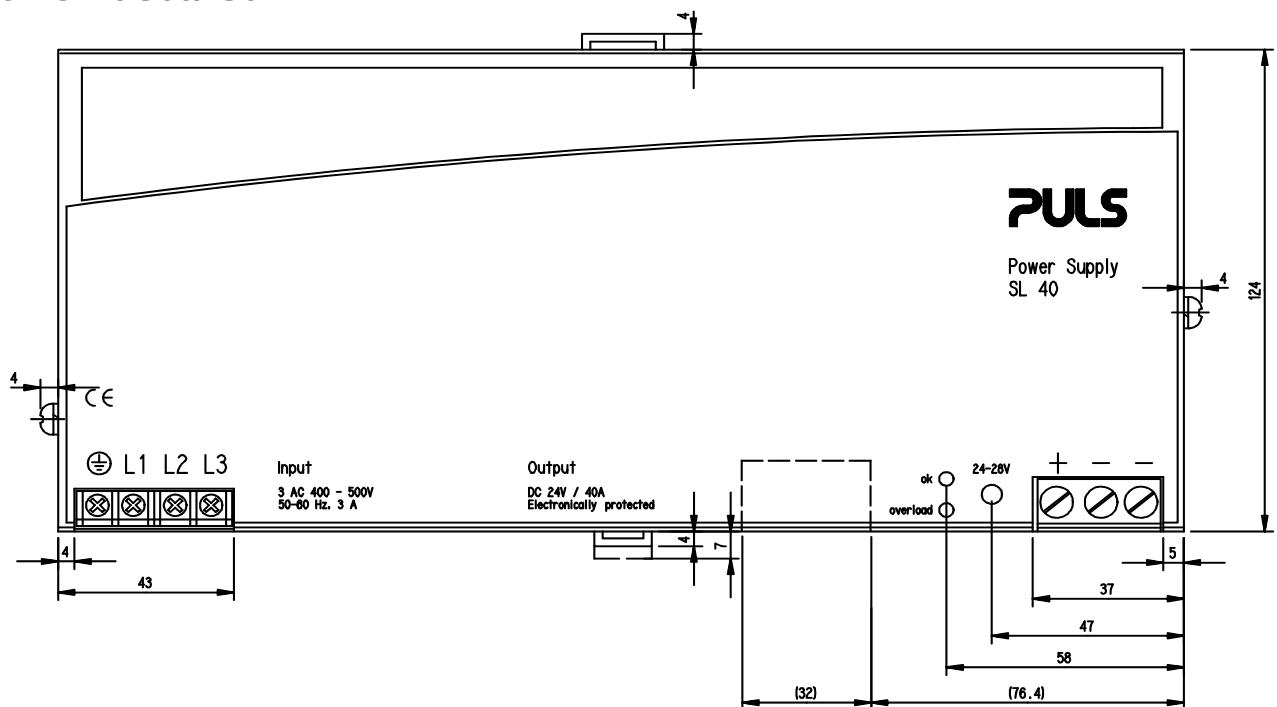

Construction / Mechanics

Housing dimensions and Weight

- W x H x D 275 mm x 124 mm x 117 mm (+ DIN rail)
- Free space for above/below each 70 mm recommended ventilation left/right each 25 mm recommended
- Weight 3.3kg

Robust metal housing with fine ventilat. grid (\diamond 3,5 mm, IP20), to keep out small parts (e.g. screws)

- Mounting
- on DIN-Rail (TS35/7.5 or TS35/15, 1...1.5 mm thick) therefore
 - Simple snap-on system
 - Sits safely and firmly on the DIN-Rail
 - No tools required to remove
 - or backplane-mounted (two optional screw mounting sets SLZ01 required)

Connections

Connections

- solid
 - flexible
 - Current handling capacity
 - Grid (distance betw. adjacent connectors)
- Screw terminals, connector size range:
 1,5...6 mm² (Outp.: 0,5...16 mm²)
 1,5...4 mm² (Outp.: 0,5...10 mm²)
 40 A each (max. acc. to UL) resp. 56 A (max. acc. to VDE)
 Output: minus terminal with 2 connectors, 9.52 mm (Input) / 10.16 mm (Output) / 5 mm (Signal output)

Design advantages:

- All connectors easy to reach as mounted at the front panel. Input and output are strictly apart from each other and so cannot be mixed up
- PVC insulated cable can be used for all connections, no thermal protection is needed

Order information

Order number	Description
SL40.300	Basic version
SL40.301	with signal outputs, signal output connector included: Order number XFB-S-W8-MSTB 06-W8
SLZ01	Screw mounting set, two needed per unit

**Bottom view
SL40.300/ .301**

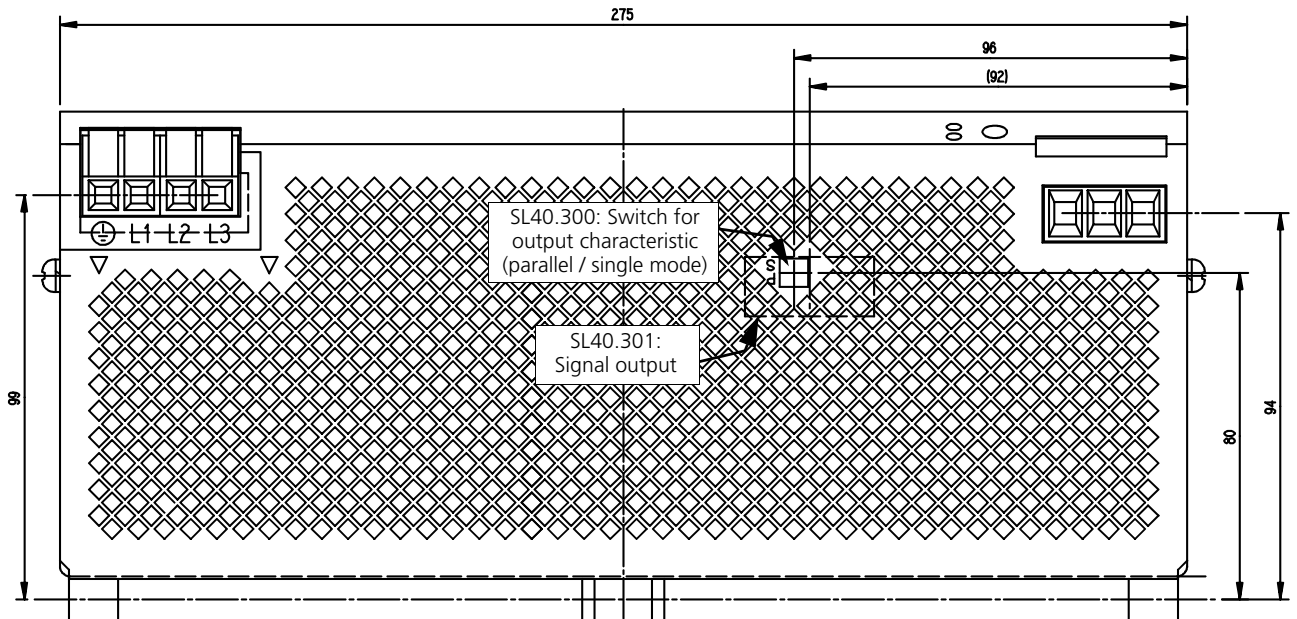

**Side view
SL40.300/ .301**

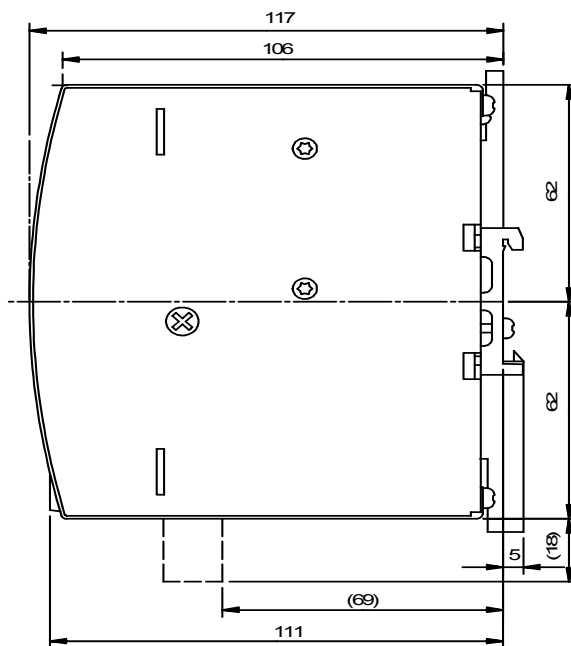

This 'mechanics data sheet' exclusively deals with the mechanical properties of the product. For further information (especially concerning electrical properties), please refer to the generic data sheet of this product and to the basic data sheet „The SilverLine“ dealing with common features of all SilverLine units. This data sheet is subject to change without prior notice

Your partner in power supply:



PULS GmbH
 Arabellastraße 15
 D-81925 München
 Tel.: +49 89 9278-0
 Fax: +49 89 9278-199
 www.puls-power.com