

High-Linearity, 650MHz to 1000MHz Upconversion/ Downconversion Mixer with LO Buffer/Switch

General Description

The MAX2031 high-linearity passive upconverter or downconverter mixer is designed to provide +36dBm IIP3, 7dB NF, and 7dB conversion loss for a 650MHz to 1000MHz RF frequency range to support GSM/cellular base-station transmitter or receiver applications. With a 650MHz to 1250MHz LO frequency range, this particular mixer is ideal for high-side LO injection architectures. For a pin-to-pin-compatible mixer meant for low-side LO injection, refer to the MAX2029.

In addition to offering excellent linearity and noise performance, the MAX2031 also yields a high level of component integration. This device includes a double-balanced passive mixer core, a dual-input LO selectable switch, and an LO buffer. On-chip baluns are also integrated to allow for a single-ended RF input for downconversion (or RF output for upconversion), and single-ended LO inputs. The MAX2031 requires a nominal LO drive of 0dBm, and supply current is guaranteed to be below 100mA.

The MAX2031 is pin compatible with the MAX2039/MAX2041 1700MHz to 2200MHz mixers, making this family of passive upconverters and downconverters ideal for applications where a common PC board layout is used for both frequency bands.

The MAX2031 is available in a compact 20-pin thin QFN package (5mm x 5mm) with an exposed pad. Electrical performance is guaranteed over the extended -40°C to +85°C temperature range.

Applications

WCDMA/LTE and
cdma2000® Base
Stations

GSM 850/GSM 900 2G
and 2.5G EDGE Base
Stations

Integrated Digital
Enhanced Network
(iDEN®) Base Stations

WiMAX™ Base Stations
and Customer Premise
Equipment

Predistortion Receivers

Microwave and Fixed
Broadband Wireless
Access

Wireless Local Loop

Digital and Spread-
Spectrum
Communication Systems

cdma2000 is a registered trademark of Telecommunications Industry Association.

iDEN is a registered trademark of Motorola, Inc.

WiMAX is a trademark of WiMAX Forum.

Features

- ◆ 650MHz to 1000MHz RF Frequency Range
- ◆ 650MHz to 1250MHz LO Frequency Range
- ◆ 570MHz to 900MHz LO Frequency Range (Refer to the MAX2029 Data Sheet)
- ◆ DC to 250MHz IF Frequency Range
- ◆ 7dB Conversion Loss
- ◆ +36dBm Input IP3
- ◆ +27dBm Input 1dB Compression Point
- ◆ 7dB Noise Figure
- ◆ Integrated LO Buffer
- ◆ Integrated RF and LO Baluns
- ◆ Low -3dBm to +3dBm LO Drive
- ◆ Built-In SPDT LO Switch with 49dB LO1 to LO2 Isolation and 50ns Switching Time
- ◆ Pin Compatible with the MAX2039/MAX2041 1700MHz to 2200MHz Mixers
- ◆ External Current-Setting Resistor Provides Option for Operating Mixer in Reduced-Power/Reduced-Performance Mode

Ordering Information

PART	TEMP RANGE	PIN-PACKAGE
MAX2031ETP+	-40°C to +85°C	20 Thin QFN-EP*
MAX2031ETP+T	-40°C to +85°C	20 Thin QFN-EP*

+ Denotes a lead(Pb)-free/RoHS-compliant package.

T = Tape and reel.

*EP = Exposed pad.

Pin Configuration/ Functional Diagram

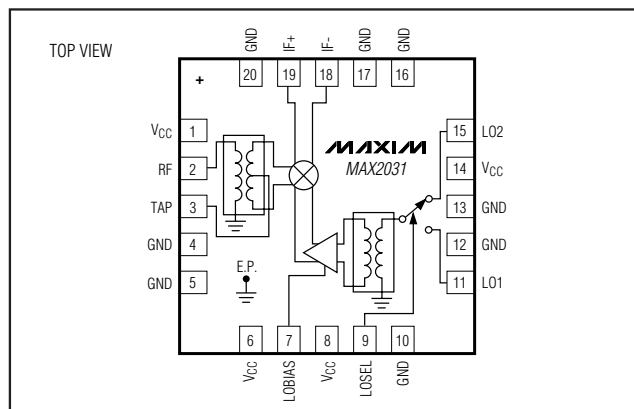

High-Linearity, 650MHz to 1000MHz Upconversion/Downconversion Mixer with LO Buffer/Switch

ABSOLUTE MAXIMUM RATINGS

V _{CC} to GND	-0.3V to +5.5V	Continuous Power Dissipation (Note 2)	5W
RF (RF is DC shorted to GND through a balun).....	50mA	θ _{JA} (Notes 3, 4).....	+38°C/W
LO1, LO2 to GND	-0.3V to +0.3V	θ _{JC} (Notes 2, 3)	+13°C/W
IF+, IF- to GND	-0.3V to (V _{CC} + 0.3V)	Operating Temperature Range (Note 5)	T _C = -40°C to +85°C
TAP to GND	-0.3V to +1.4V	Junction Temperature	+150°C
LOSEL to GND	-0.3V to (V _{CC} + 0.3V)	Storage Temperature Range	-65°C to +150°C
LOBIAS to GND	-0.3V to (V _{CC} + 0.3V)	Lead Temperature (soldering, 10s)	+300°C
RF, LO1, LO2 Input Power (Note 1)	+20dBm		

Note 1: Maximum, reliable, continuous input power applied to the RF and IF port of this device is +12dBm from a 50Ω source.

Note 2: Based on junction temperature $T_J = T_C + (\theta_{JC} \times V_{CC} \times I_{CC})$. This formula can be used when the temperature of the exposed pad is known while the device is soldered down to a PCB. See the *Applications Information* section for details. The junction temperature must not exceed +150°C.

Note 3: Package thermal resistances were obtained using the method described in JEDEC specification JESD51-7, using a four-layer board. For detailed information on package thermal considerations, refer to www.maxim-ic.com/thermal-tutorial.

Note 4: Junction temperature $T_J = T_A + (\theta_{JA} \times V_{CC} \times I_{CC})$. This formula can be used when the ambient temperature of the PCB is known. The junction temperature must not exceed +150°C.

Note 5: T_C is the temperature on the exposed pad of the package. T_A is the ambient temperature of the device and PCB.

Stresses beyond those listed under "Absolute Maximum Ratings" may cause permanent damage to the device. These are stress ratings only, and functional operation of the device at these or any other conditions beyond those indicated in the operational sections of the specifications is not implied. Exposure to absolute maximum rating conditions for extended periods may affect device reliability.

DC ELECTRICAL CHARACTERISTICS

(Typical Application Circuit, V_{CC} = 4.75V to 5.25V, no RF signals applied, T_C = -40°C to +85°C. IF+ and IF- are DC grounded through an IF balun. Typical values are at V_{CC} = 5V, T_C = +25°C, unless otherwise noted.)

PARAMETER	SYMBOL	CONDITIONS	MIN	TYP	MAX	UNITS
Supply Voltage	V _{CC}		4.75	5.00	5.25	V
Supply Current	I _{CC}			85	100	mA
LOSEL Input-Logic Low	V _{IL}				0.8	V
LOSEL Input-Logic High	V _{IH}		2			V

RECOMMENDED AC OPERATING CONDITIONS

PARAMETER	SYMBOL	CONDITIONS	MIN	TYP	MAX	UNITS
RF Frequency	f _{RF}	Components tuned for the 700MHz band (Table 1), C1 = 7pF, C5 = 3.3pF (Notes 6, 7)	650		850	MHz
		Components tuned for the 800MHz/900MHz cellular band (Table 1), C1 = 82pF, C5 = 2.0pF (Note 6)	800		1000	
LO Frequency	f _{LO}	(Notes 6, 7)	650		1250	MHz
IF Frequency	f _{IF}	IF frequency range depends on external IF transformer selection	0		250	MHz
LO Drive Level	P _{LO}	(Note 6)	-3		+3	dBm

High-Linearity, 650MHz to 1000MHz Upconversion/ Downconversion Mixer with LO Buffer/Switch

AC ELECTRICAL CHARACTERISTICS (800MHz/900MHz CELLULAR BAND DOWNCONVERTER OPERATION)

(Typical Application Circuit, optimized for the **800MHz/900MHz cellular band** (see Table 1), C1 = 82pF, C5 = 2pF, L1 and C4 not used, V_{CC} = 4.75V to 5.25V, RF and LO ports driven from 50Ω sources, P_{LO} = -3dBm to +3dBm, P_{RF} = 0dBm, f_{RF} = 815MHz to 1000MHz, f_{LO} = 960MHz to 1180MHz, f_{IF} = 160MHz, f_{LO} > f_{RF}, T_C = -40°C to +85°C, unless otherwise noted. Typical values are at V_{CC} = 5V, P_{RF} = 0dBm, P_{LO} = 0dBm, f_{RF} = 910MHz, f_{LO} = 1070MHz, f_{IF} = 160MHz, T_C = +25°C, unless otherwise noted.) (Note 8)

PARAMETER	SYMBOL	CONDITIONS	MIN	TYP	MAX	UNITS
Conversion Loss	Lc			7.0		dB
Conversion Loss Flatness		Flatness over any one of three frequency bands (f _{IF} = 160MHz): f _{RF} = 827MHz to 849MHz f _{RF} = 869MHz to 894MHz f _{RF} = 880MHz to 915MHz		±0.18		dB
Conversion Loss Variation Over Temperature		T _C = +25°C to -40°C		-0.3		dB
		T _C = +25°C to +85°C		0.2		
Input Compression Point	P _{1dB}	(Note 9)		27		dBm
Input Third-Order Intercept Point	IIP3	f _{RF1} = 910MHz, f _{RF2} = 911MHz, P _{RF} = 0dBm/tone, f _{LO} = 1070MHz, P _{LO} = 0dBm, T _C = +25°C (Note 10)	32	36		dBm
Input IP3 Variation Over Temperature	IIP3	T _C = +25°C to -40°C		0.3		dB
		T _C = +25°C to +85°C		-0.3		
Spurious Response at IF	2 x 2	2LO - 2RF		72		dBc
	3 x 3	3LO - 3RF		79		
Noise Figure	NF	Single sideband		7.0		dB
Noise Figure Under Blocking (Note 11)		P _{BLOCKER} = +8dBm		15		dB
		P _{BLOCKER} = +12dBm		19		
LO1-to-LO2 Isolation (Note 10)		LO2 selected, P _{LO} = +3dBm, T _C = +25°C	42	51		dB
		LO1 selected, P _{LO} = +3dBm, T _C = +25°C	42	49		
Maximum LO Leakage at RF Port		P _{LO} = +3dBm		-27		dBm
Maximum LO Leakage at IF Port		P _{LO} = +3dBm		-35		dBm
LO Switching Time		50% of LOSEL to IF, settled within 2 degrees		50		ns
Minimum RF-to-IF Isolation				45		dB
RF Port Return Loss				17		dB
LO Port Return Loss		LO1/LO2 port selected, LO2/LO1, RF, and IF terminated into 50Ω		28		dB
		LO1/LO2 port unselected, LO2/LO1, RF, and IF terminated into 50Ω		30		
IF Port Return Loss		LO driven at 0dBm, RF terminated into 50Ω		17		dB

High-Linearity, 650MHz to 1000MHz Upconversion/Downconversion Mixer with LO Buffer/Switch

AC ELECTRICAL CHARACTERISTICS (700MHz BAND DOWNCONVERTER OPERATION)

(Typical Application Circuit, optimized for the 700MHz band (see Table 1), C1 = 7pF, C5 = 3.3pF, L1 and C4 are not used, V_{CC} = 4.75V to 5.25V, RF and LO ports driven from 50Ω sources, P_{LO} = -3dBm to +3dBm, P_{RF} = 0dBm, f_{RF} = 650MHz to 850MHz, f_{LO} = 790MHz to 990MHz, f_{IF} = 140MHz, f_{LO} > f_{RF}, T_C = +25°C, unless otherwise noted. Typical values are at V_{CC} = 5V, P_{RF} = 0dBm, P_{LO} = 0dBm, f_{RF} = 750MHz, f_{LO} = 890MHz, f_{IF} = 140MHz, T_C = +25°C, unless otherwise noted.) (Notes 8, 10)

PARAMETER	SYMBOL	CONDITIONS	MIN	TYP	MAX	UNITS
Conversion Loss	L _C		6.1	6.9	8.1	dB
Input 1dB Compression Point	P _{1dB}	f _{RF} = 750MHz, P _{RF} = 0dBm, P _{LO} = 0dBm		27.7		dBm
Input Third-Order Intercept Point	IIP3	f _{RF1} = 749MHz, f _{RF2} = 750MHz, f _{LO} = 890MHz, P _{RF} = 0dBm/tone, P _{LO} = 0dBm	32	37		dBm
LO Leakage at IF Port		P _{LO} = +3dBm		-33	-21	dBm
LO Leakage at RF Port		P _{LO} = +3dBm		-20	-13	dBm
RF-to-IF Isolation			36	49		dB
2LO-2RF Spurious Response	2 x 2		40	72		dBc
3LO-3RF Spurious Response	3 x 3		65	82		dBc

AC ELECTRICAL CHARACTERISTICS (UPCONVERTER OPERATION)

(Typical Application Circuit, L1 = 4.7nH, C4 = 6pF, C1 = 82pF, C5 not used, V_{CC} = 4.75V to 5.25V, RF and LO ports are driven from 50Ω sources, P_{LO} = -3dBm to +3dBm, P_{IF} = 0dBm, f_{RF} = 815MHz to 1000MHz, f_{LO} = 960MHz to 1180MHz, f_{IF} = 160MHz, f_{LO} > f_{RF}, T_C = -40°C to +85°C, unless otherwise noted. Typical values are at V_{CC} = 5V, P_{IF} = 0dBm, P_{LO} = 0dBm, f_{RF} = 910MHz, f_{LO} = 1070MHz, f_{IF} = 160MHz, T_C = +25°C, unless otherwise noted.) (Note 8)

PARAMETER	SYMBOL	CONDITIONS	MIN	TYP	MAX	UNITS
Conversion Loss	L _c			7.4		dB
Conversion Loss Flatness		Flatness over any one of three frequency bands (f _{IF} = 160MHz): f _{RF} = 827MHz to 849MHz f _{RF} = 869MHz to 894MHz f _{RF} = 880MHz to 915MHz		±0.3		dB
Conversion Loss Variation Over Temperature		T _C = +25°C to -40°C T _C = +25°C to +85°C		-0.3 0.4		dB
Input Compression Point	P _{1dB}	(Note 9)		27		dBm
Input Third-Order Intercept Point	IIP3	f _{IF1} = 160MHz, f _{IF2} = 161MHz, P _{IF} = 0dBm/tone, f _{LO} = 1070MHz, P _{LO} = 0dBm, T _C = +25°C (Note 10)	32	36		dBm
Input IP3 Variation Over Temperature	IIP3	T _C = +25°C to -40°C T _C = +25°C to +85°C		1.2 -0.9		dB
LO ± 2IF Spur				64		dBc
LO ± 3IF Spur				83		dBc
Output Noise Floor		P _{OUT} = 0dBm (Note 11)		-167		dBm/Hz

Note 6: Operation outside this range is possible, but with degraded performance of some parameters.

Note 7: Not production tested.

Note 8: All limits include external component losses. Output measurements are taken at IF or RF port of the *Typical Application Circuit*.

Note 9: Compression point characterized. It is advisable not to continuously operate the mixer RF/IF inputs above +12dBm.

Note 10: Guaranteed by design.

Note 11: Measured with external LO source noise filtered, so its noise floor is -174dBm/Hz. This specification reflects the effects of all SNR degradations in the mixer, including the LO noise as defined in Application Note 2021: *Specifications and Measurements of Local Oscillator Noise in Integrated Circuit Base Station Mixers*.

High-Linearity, 650MHz to 1000MHz Upconversion/Downconversion Mixer with LO Buffer/Switch

Typical Operating Characteristics

(Typical Application Circuit, optimized for the 800MHz/900MHz cellular band (see Table 1), C1 = 82pF, C5 = 2pF, L1 and C4 not used, V_{CC} = 5.0V, P_{LO} = 0dBm, P_{RF} = 0dBm, f_{LO} > f_{RF}, f_{IF} = 160MHz, T_C = +25°C, unless otherwise noted.)

Downconverter Curves

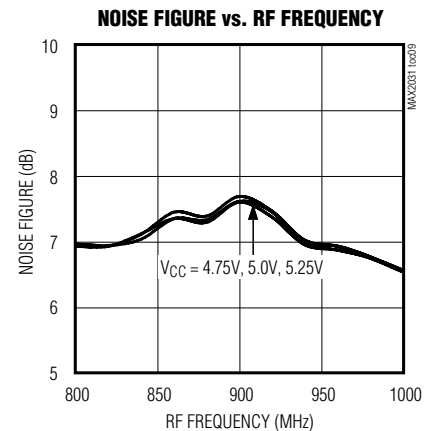
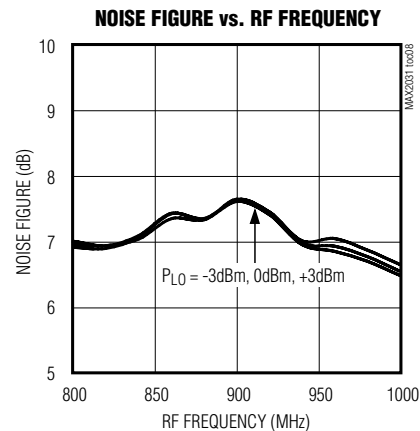
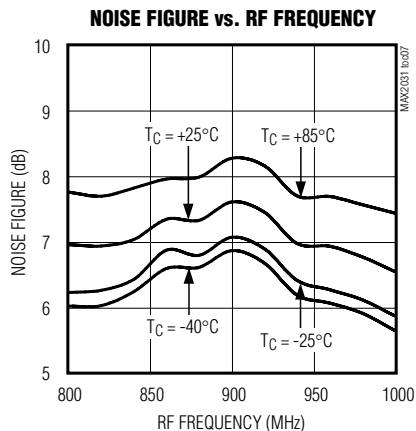
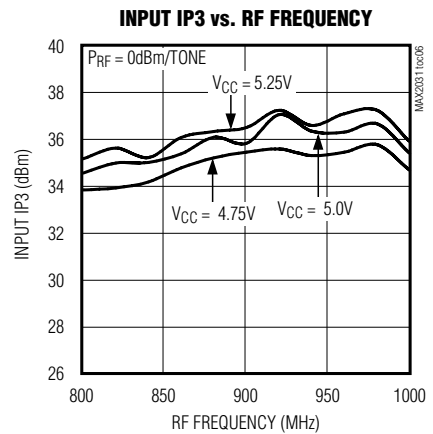
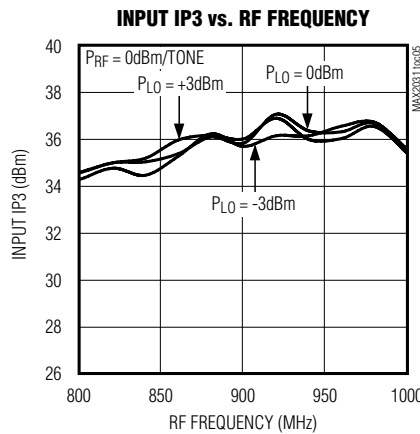
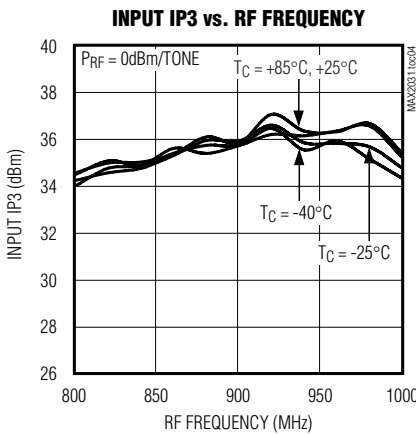
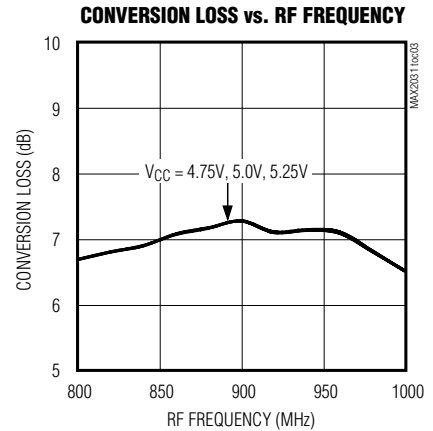
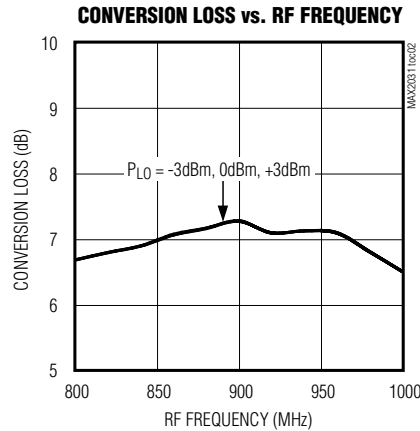
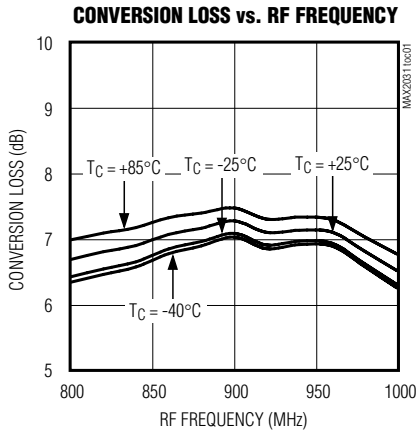

High-Linearity, 650MHz to 1000MHz Upconversion/Downconversion Mixer with LO Buffer/Switch

Typical Operating Characteristics (continued)

(Typical Application Circuit, optimized for the 800MHz/900MHz cellular band (see Table 1), C1 = 82pF, C5 = 2pF, L1 and C4 not used, V_{CC} = 5.0V, P_{LO} = 0dBm, P_{RF} = 0dBm, f_{LO} > f_{RF}, f_{IF} = 160MHz, T_C = +25°C, unless otherwise noted.)

Downconverter Curves

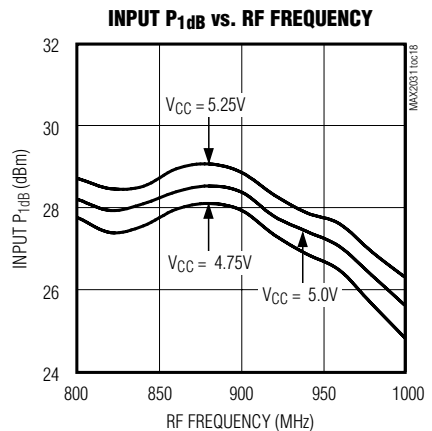
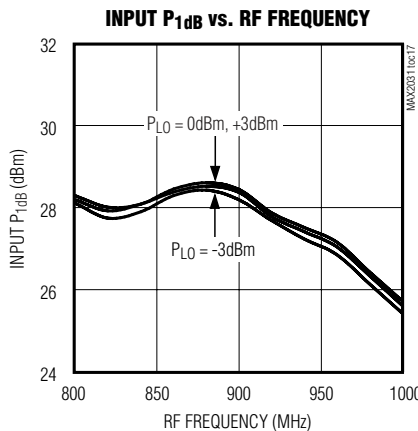
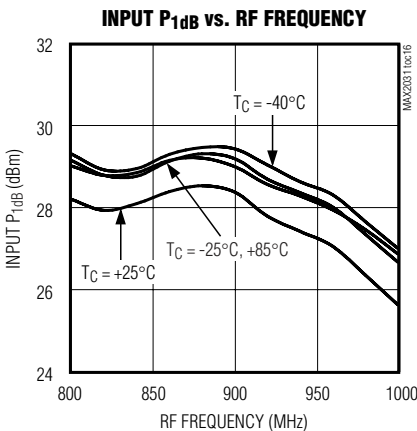
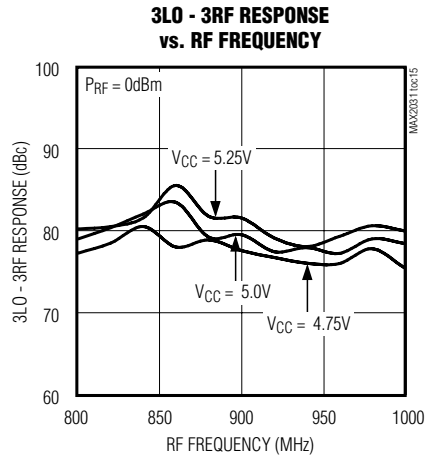
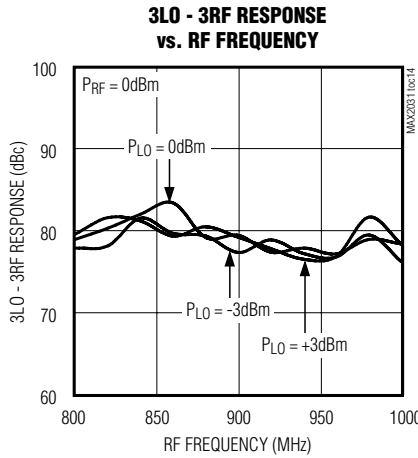
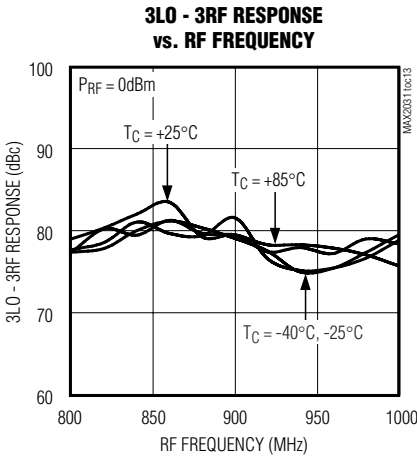
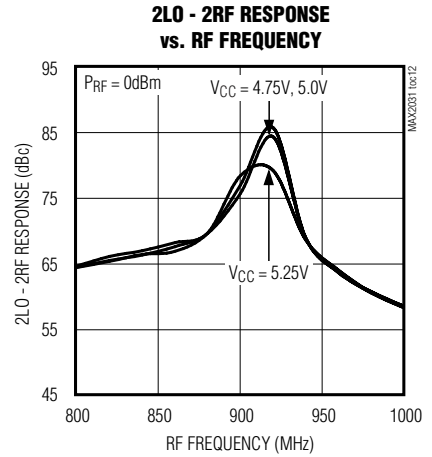
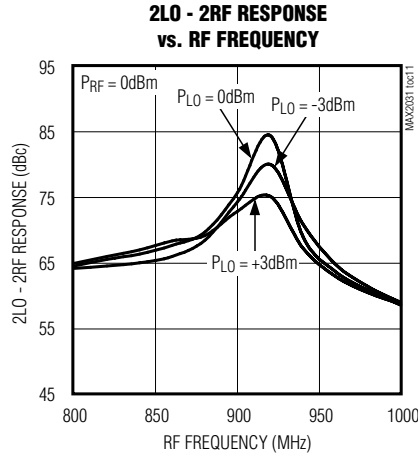
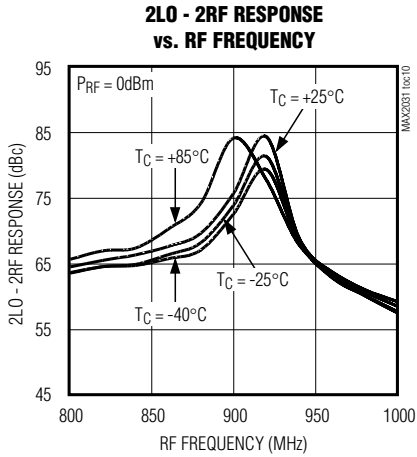

High-Linearity, 650MHz to 1000MHz Upconversion/ Downconversion Mixer with LO Buffer/Switch

Typical Operating Characteristics (continued)

(Typical Application Circuit, optimized for the 800MHz/900MHz cellular band (see Table 1), C1 = 82pF, C5 = 2pF, L1 and C4 not used, V_{CC} = 5.0V, P_{LO} = 0dBm, P_{RF} = 0dBm, f_{LO} > f_{RF}, f_{IF} = 160MHz, T_C = +25°C, unless otherwise noted.)

Downconverter Curves

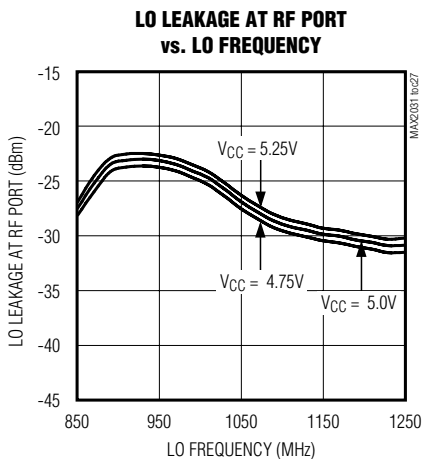
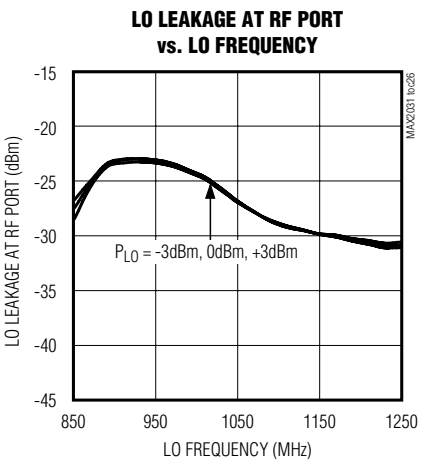
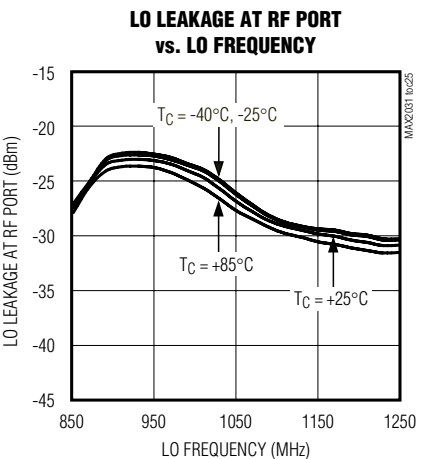
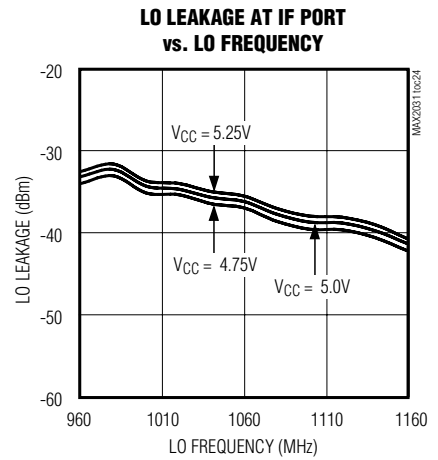
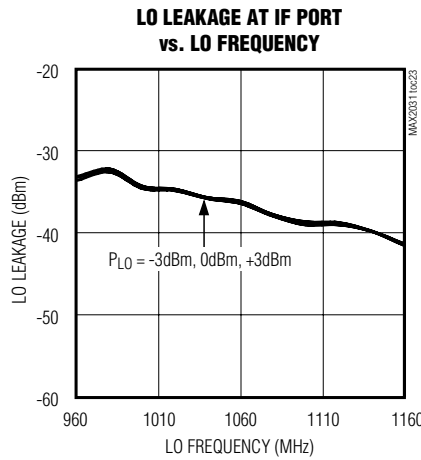
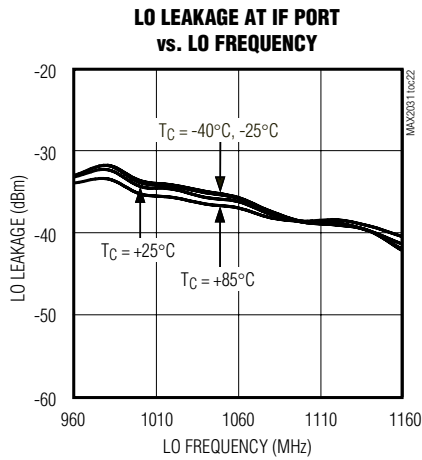
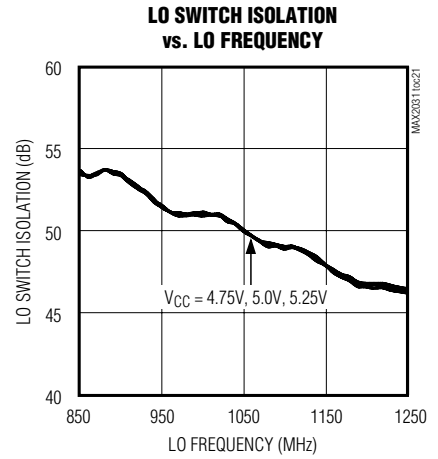
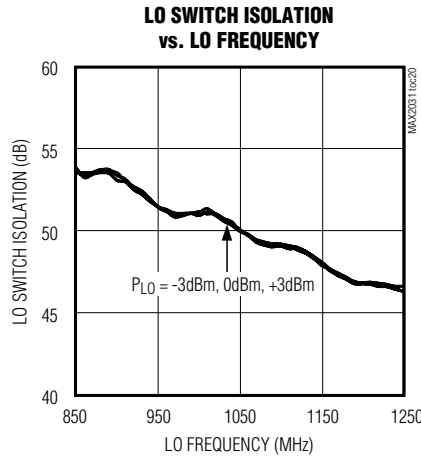
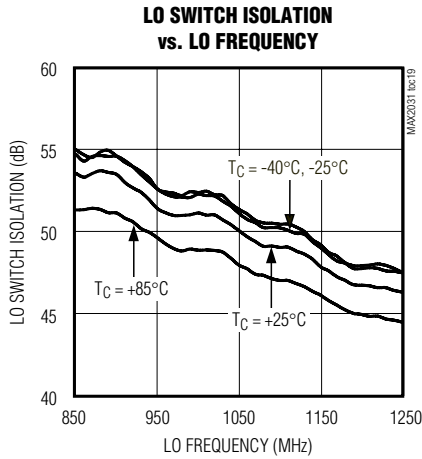

High-Linearity, 650MHz to 1000MHz Upconversion/Downconversion Mixer with LO Buffer/Switch

Typical Operating Characteristics (continued)

(Typical Application Circuit, optimized for the 800MHz/900MHz cellular band (see Table 1), C1 = 82pF, C5 = 2pF, L1 and C4 not used, V_{CC} = 5.0V, P_{LO} = 0dBm, P_{RF} = 0dBm, f_{LO} > f_{RF}, f_{IF} = 160MHz, T_C = +25°C, unless otherwise noted.)

Downconverter Curves

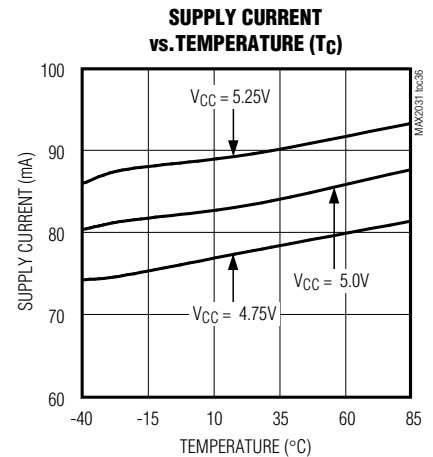
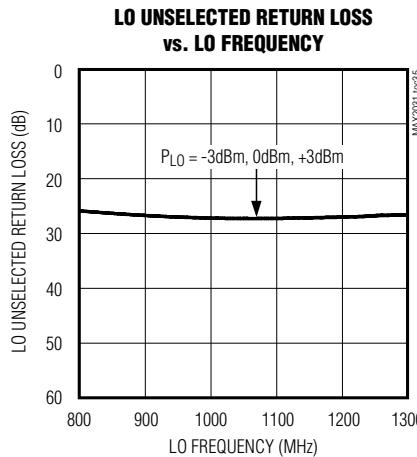
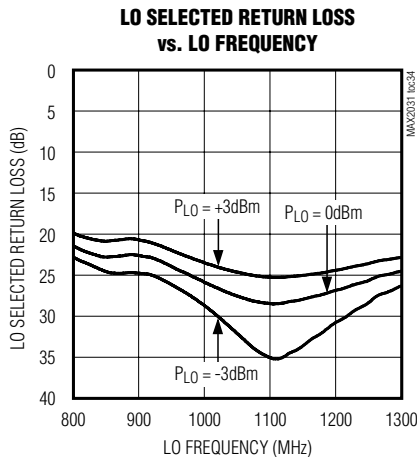
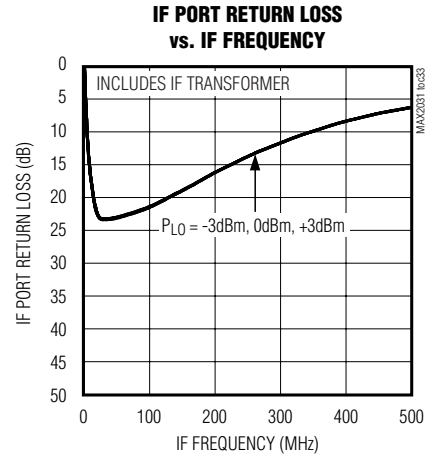
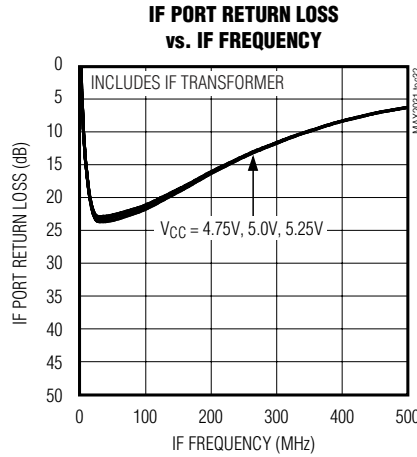
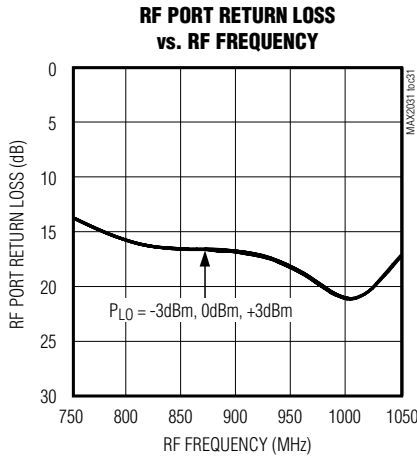
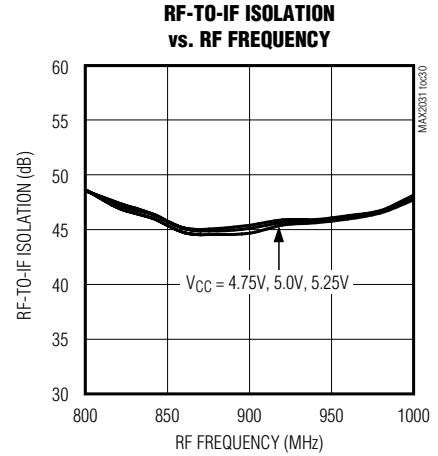
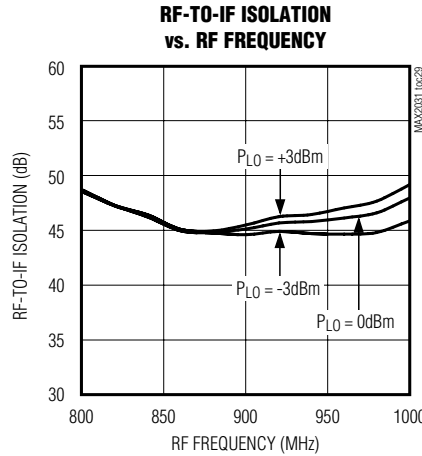
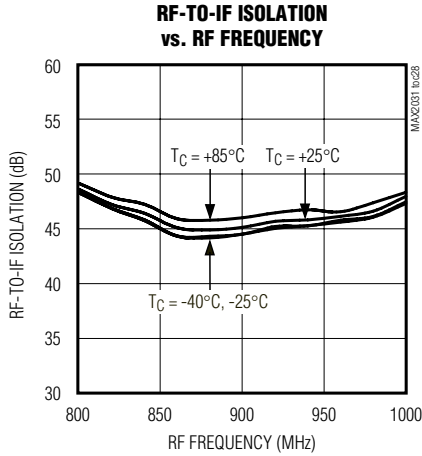

High-Linearity, 650MHz to 1000MHz Upconversion/Downconversion Mixer with LO Buffer/Switch

Typical Operating Characteristics (continued)

(Typical Application Circuit, optimized for the 700MHz band (see Table 1), $C_1 = 7\text{pF}$, $C_5 = 3.3\text{pF}$, L_1 and C_4 are not used, $V_{CC} = 5\text{V}$, $P_{LO} = 0\text{dBm}$, $P_{RF} = 0\text{dBm}$, $f_{LO} > f_{RF}$, $f_{IF} = 140\text{MHz}$, $T_C = +25^\circ\text{C}$, unless otherwise noted.)

Downconverter Curves

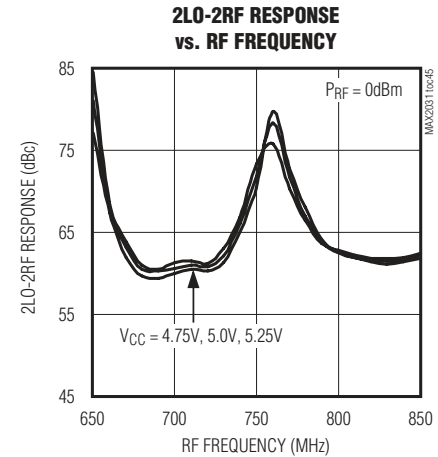
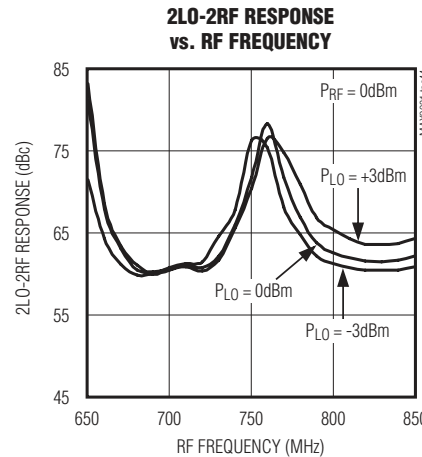
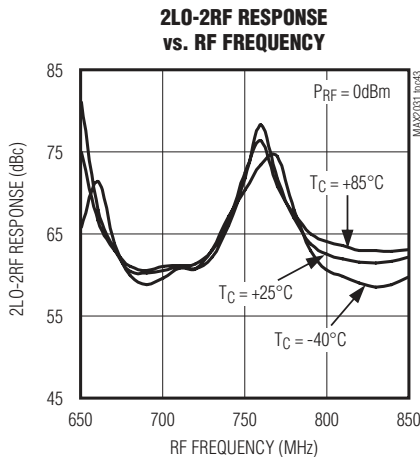
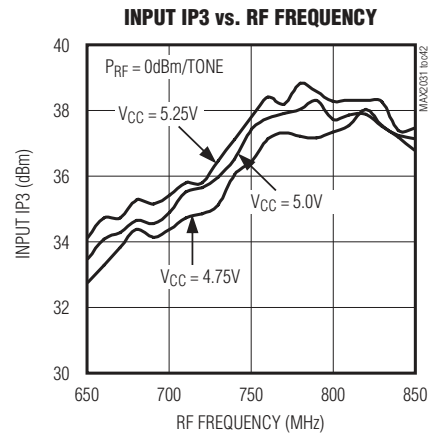
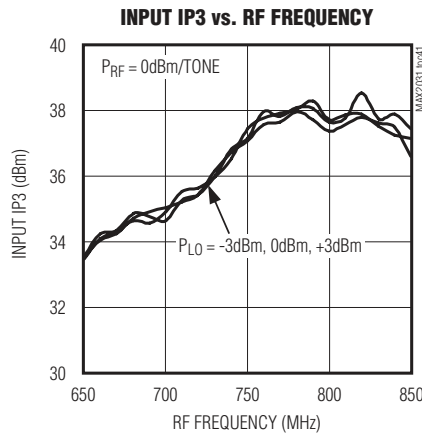
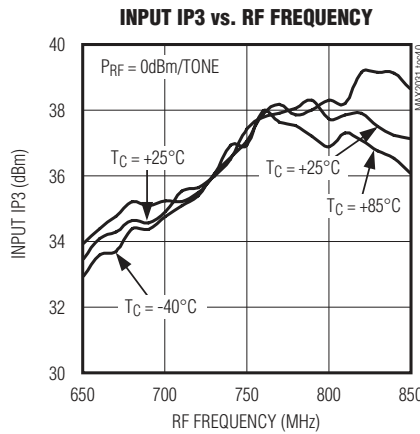
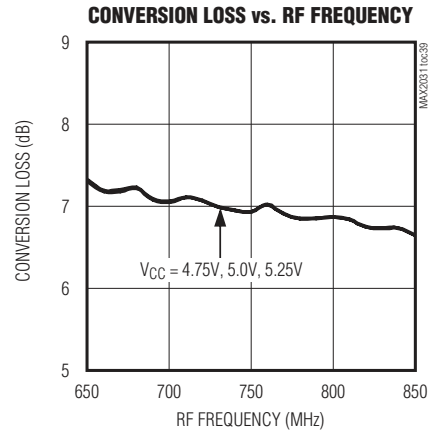
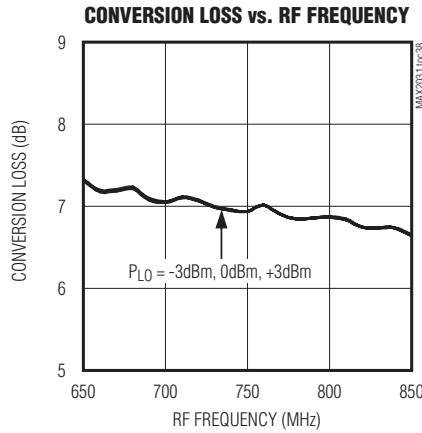
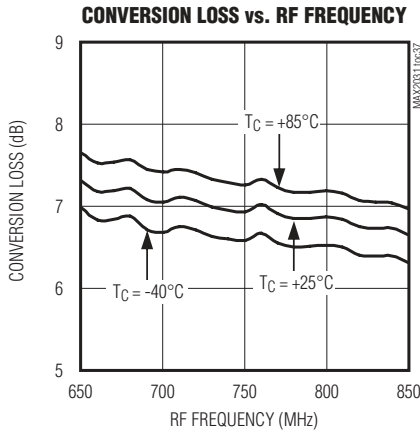

High-Linearity, 650MHz to 1000MHz Upconversion/Downconversion Mixer with LO Buffer/Switch

Typical Operating Characteristics (continued)

(Typical Application Circuit, optimized for the 700MHz band (see Table 1), $C_1 = 7\text{pF}$, $C_5 = 3.3\text{pF}$, L_1 and C_4 are not used, $V_{CC} = 5\text{V}$, $P_{LO} = 0\text{dBm}$, $P_{RF} = 0\text{dBm}$, $f_{LO} > f_{RF}$, $f_{IF} = 140\text{MHz}$, $T_C = +25^\circ\text{C}$, unless otherwise noted.)

Downconverter Curves

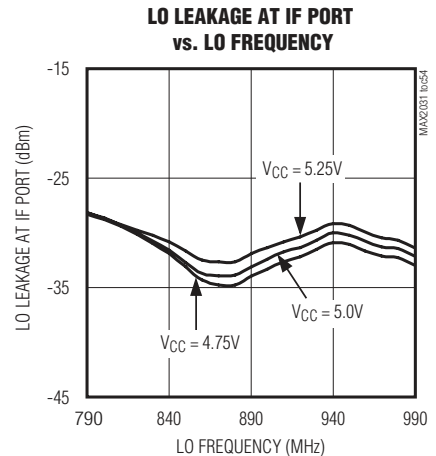
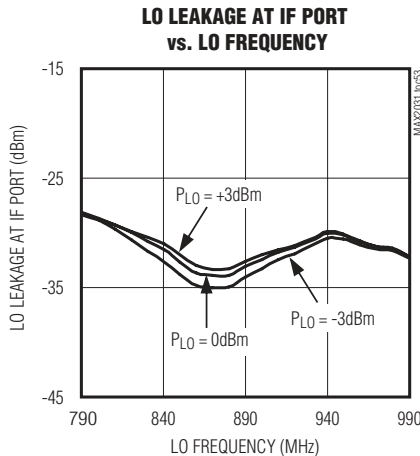
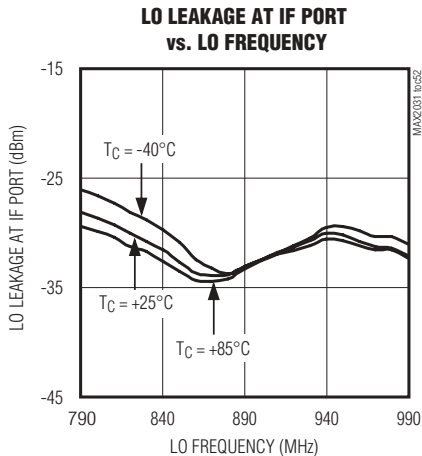
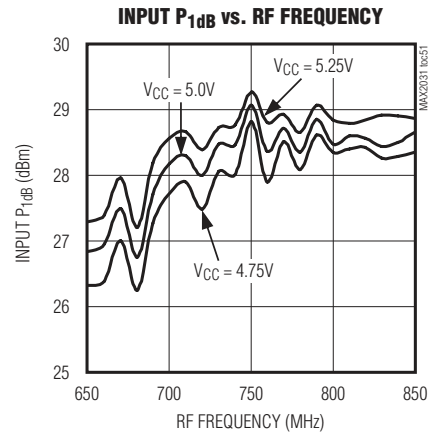
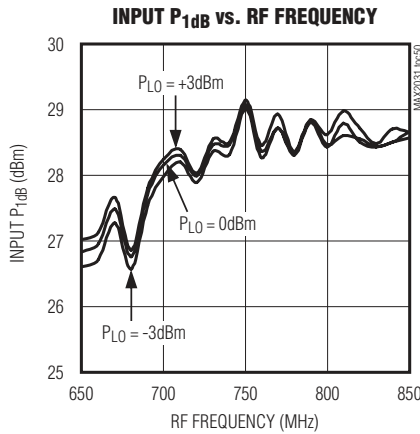
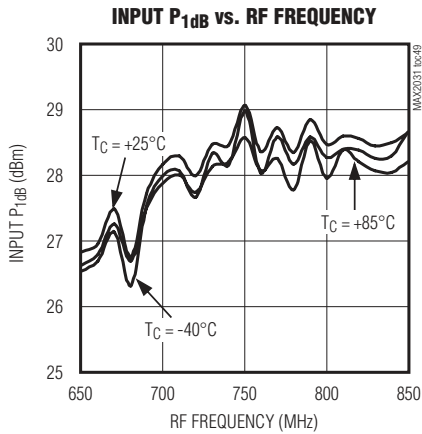
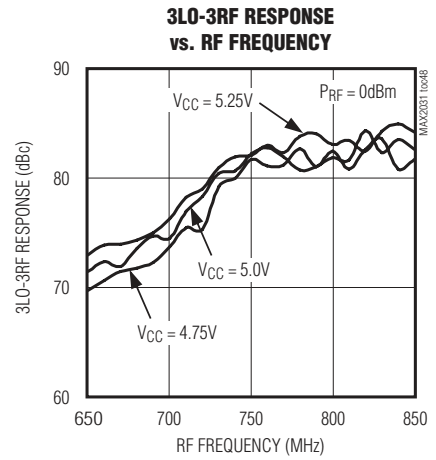
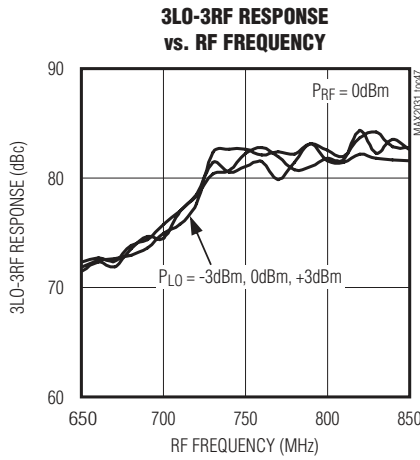
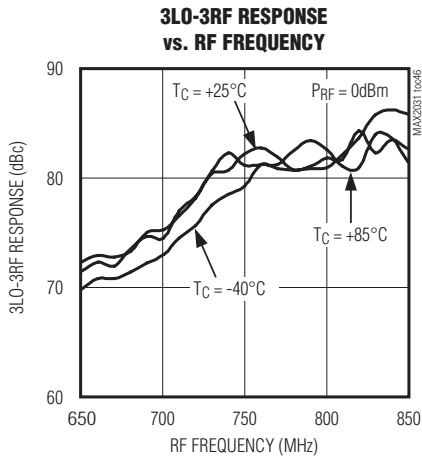

High-Linearity, 650MHz to 1000MHz Upconversion/Downconversion Mixer with LO Buffer/Switch

Typical Operating Characteristics (continued)

(Typical Application Circuit, optimized for the 700MHz band (see Table 1), $C_1 = 7\text{pF}$, $C_5 = 3.3\text{pF}$, L_1 and C_4 are not used, $V_{CC} = 5\text{V}$, $P_{LO} = 0\text{dBm}$, $P_{RF} = 0\text{dBm}$, $f_{LO} > f_{RF}$, $f_{IF} = 140\text{MHz}$, $T_C = +25^\circ\text{C}$, unless otherwise noted.)

Downconverter Curves

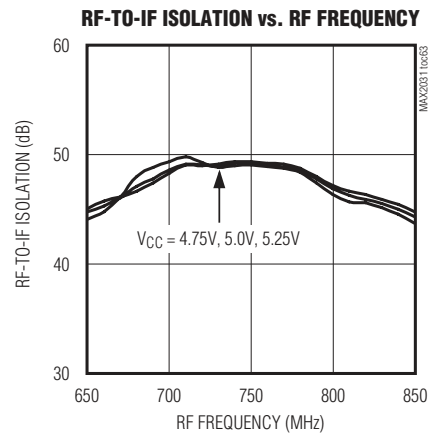
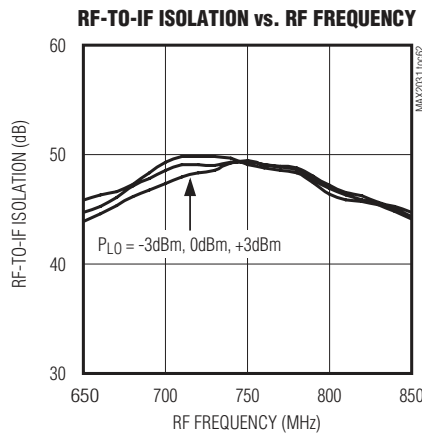
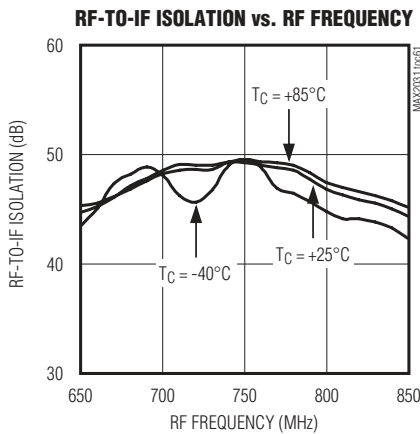
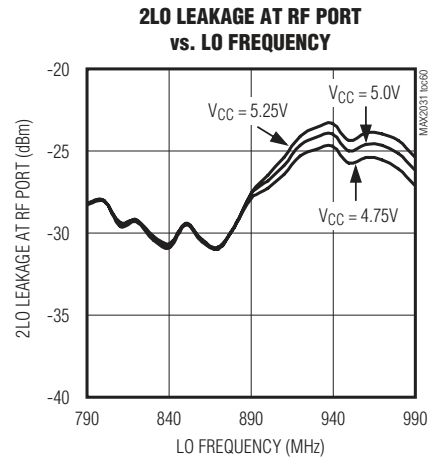
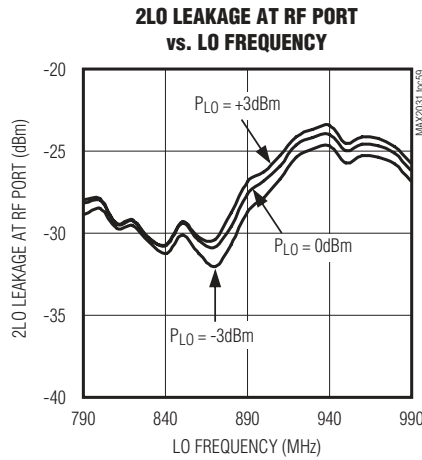
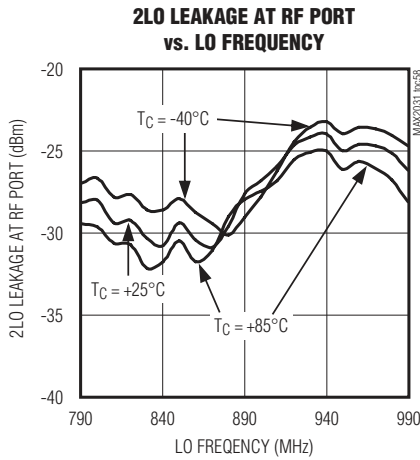
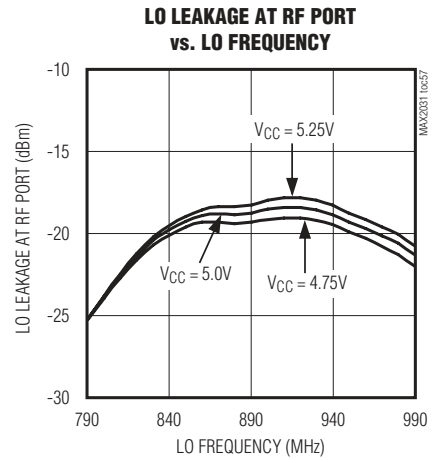
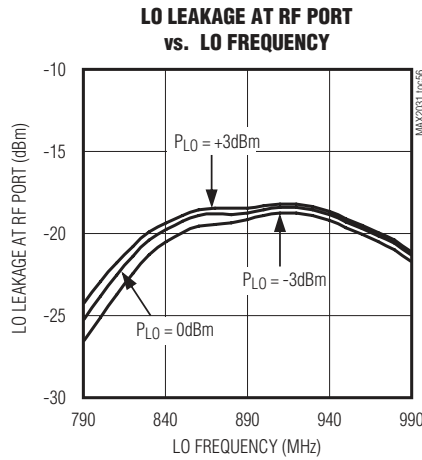
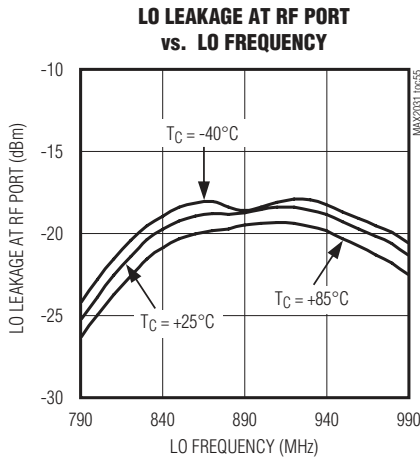

High-Linearity, 650MHz to 1000MHz Upconversion/Downconversion Mixer with LO Buffer/Switch

Typical Operating Characteristics (continued)

(Typical Application Circuit, optimized for the 700MHz band (see Table 1), $C1 = 7pF$, $C5 = 3.3pF$, $L1$ and $C4$ are not used, $V_{CC} = 5V$, $P_{LO} = 0dBm$, $P_{RF} = 0dBm$, $f_{LO} > f_{RF}$, $f_{IF} = 140MHz$, $T_C = +25^\circ C$, unless otherwise noted.)

Downconverter Curves

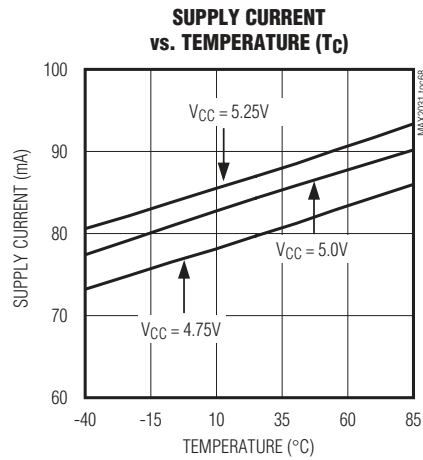
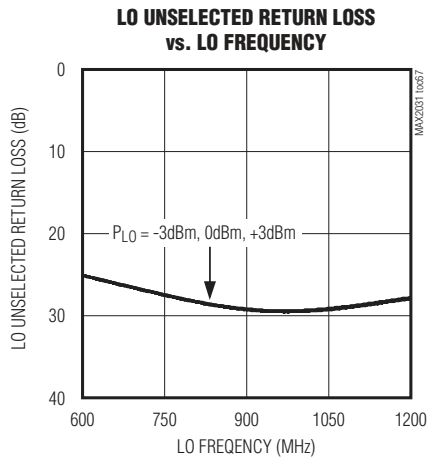
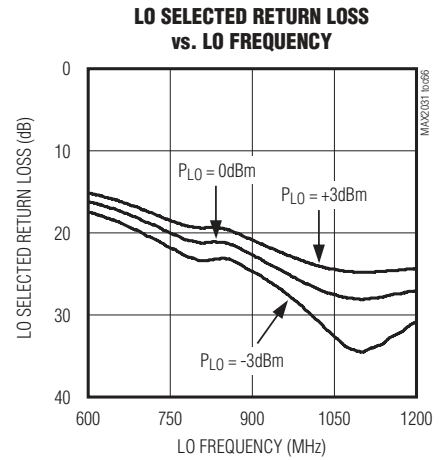
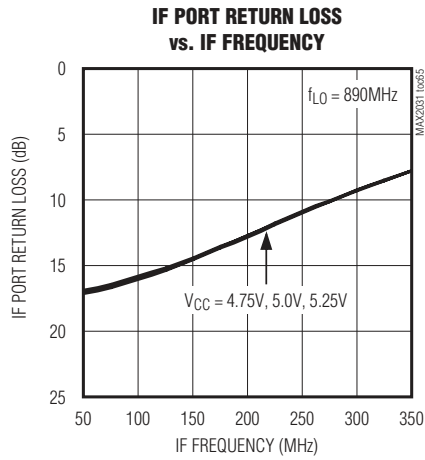
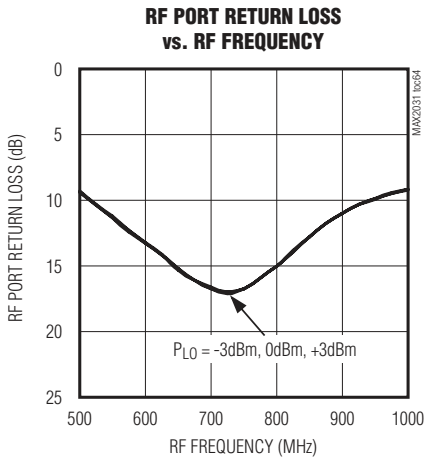

High-Linearity, 650MHz to 1000MHz Upconversion/Downconversion Mixer with LO Buffer/Switch

Typical Operating Characteristics (continued)

(Typical Application Circuit, L1 = 4.7nH, C4 = 6pF, C5 not used, VCC = 5.0V, PLO = 0dBm, PIF = 0dBm, fRF = fLO + fIF, fIF = 160MHz, TC = +25°C, unless otherwise noted.)

Upconverter Curves

CONVERSION LOSS vs. RF FREQUENCY
(L-C BPF TUNED FOR 810MHz RF FREQUENCY)

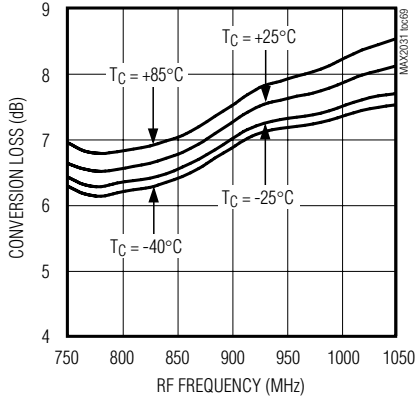

CONVERSION LOSS vs. RF FREQUENCY
(L-C BPF TUNED FOR 810MHz RF FREQUENCY)

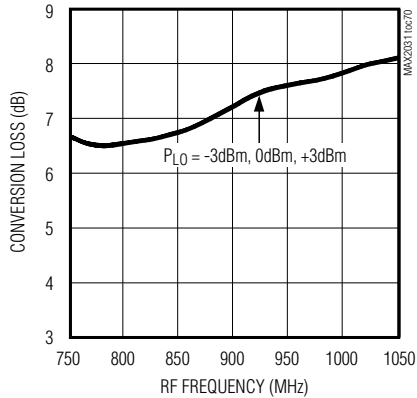

CONVERSION LOSS vs. RF FREQUENCY
(L-C BPF TUNED FOR 810MHz RF FREQUENCY)

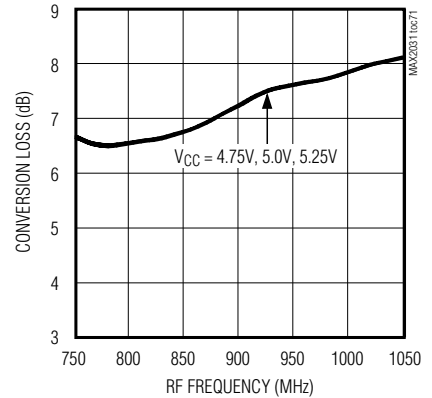

INPUT IP3 vs. RF FREQUENCY
(L-C BPF TUNED FOR 810MHz RF FREQUENCY)

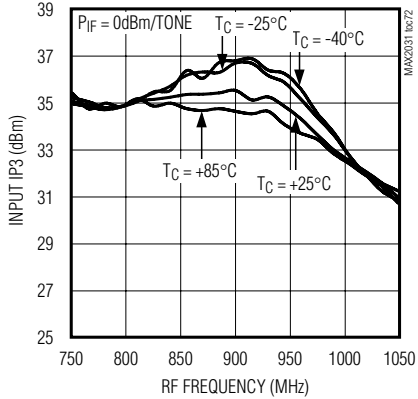

INPUT IP3 vs. RF FREQUENCY
(L-C BPF TUNED FOR 810MHz RF FREQUENCY)

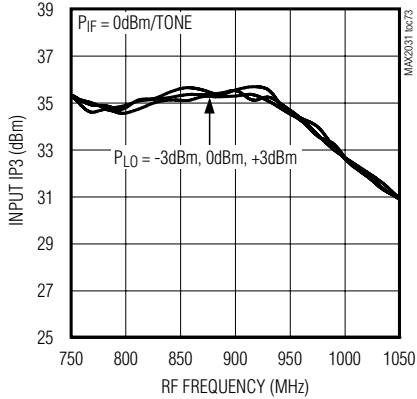

INPUT IP3 vs. RF FREQUENCY
(L-C BPF TUNED FOR 810MHz RF FREQUENCY)

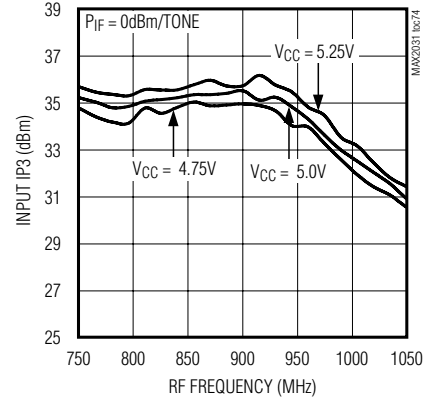

LO + 2IF REJECTION vs. LO FREQUENCY
(L-C BPF TUNED FOR 810MHz RF FREQUENCY)

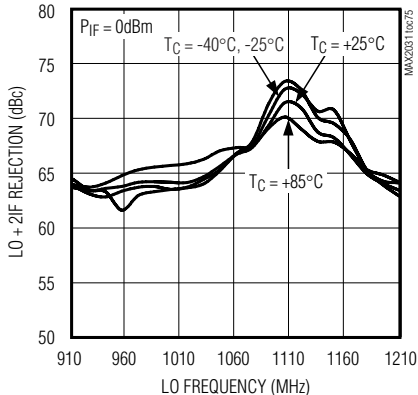

LO + 2IF REJECTION vs. LO FREQUENCY
(L-C BPF TUNED FOR 810MHz RF FREQUENCY)

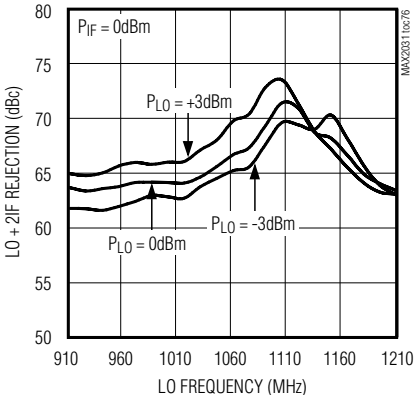

LO + 2IF REJECTION vs. LO FREQUENCY
(L-C BPF TUNED FOR 810MHz RF FREQUENCY)

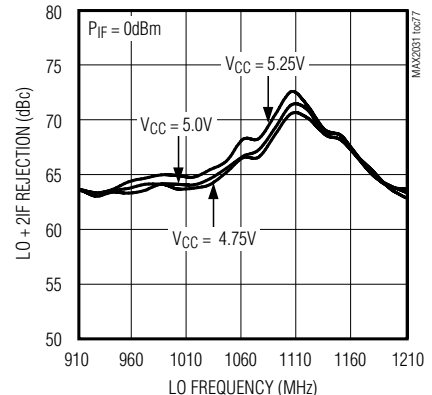

High-Linearity, 650MHz to 1000MHz Upconversion/Downconversion Mixer with LO Buffer/Switch

Typical Operating Characteristics (continued)

(Typical Application Circuit, $L1 = 4.7nH$, $C4 = 6pF$, $C5$ not used, $V_{CC} = 5.0V$, $P_{LO} = 0dBm$, $P_{IF} = 0dBm$, $f_{RF} = f_{LO} + f_{IF}$, $f_{IF} = 160MHz$, $T_C = +25^\circ C$, unless otherwise noted.)

Upconverter Curves

LO - 2IF REJECTION vs. LO FREQUENCY (L-C BPF TUNED FOR 810MHz RF FREQUENCY)

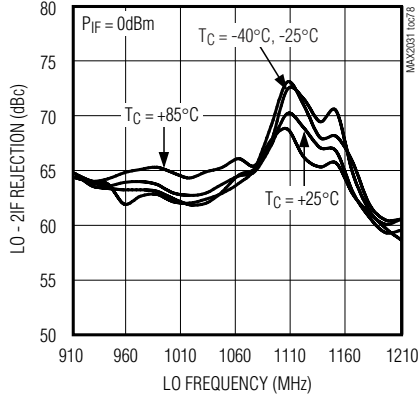

LO - 2IF REJECTION vs. LO FREQUENCY (L-C BPF TUNED FOR 810MHz RF FREQUENCY)

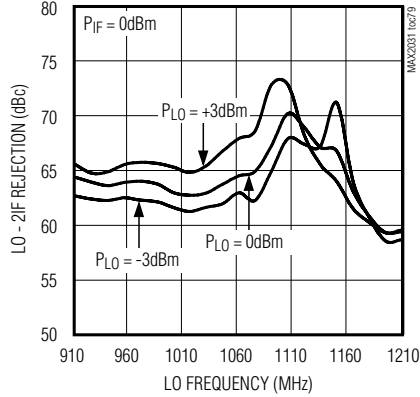

LO - 2IF REJECTION vs. LO FREQUENCY (L-C BPF TUNED FOR 810MHz RF FREQUENCY)

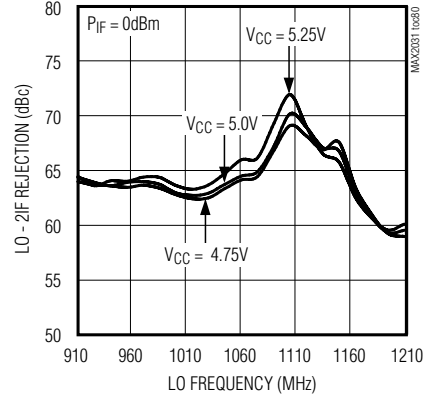

LO + 3IF REJECTION vs. LO FREQUENCY (L-C BPF TUNED FOR 810MHz RF FREQUENCY)

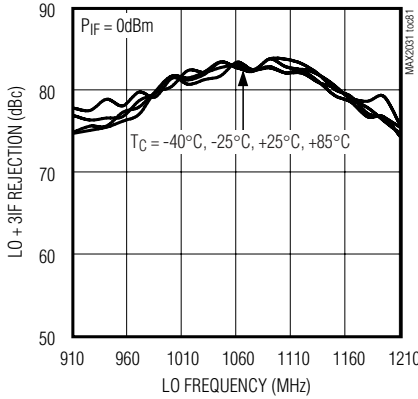

LO + 3IF REJECTION vs. LO FREQUENCY (L-C BPF TUNED FOR 810MHz RF FREQUENCY)

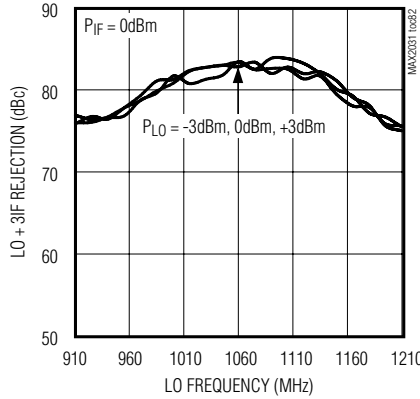

LO + 3IF REJECTION vs. LO FREQUENCY (L-C BPF TUNED FOR 810MHz RF FREQUENCY)

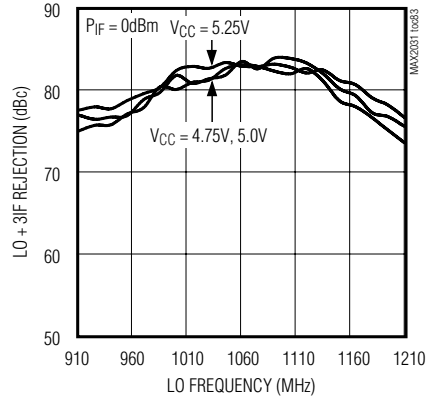

LO - 3IF REJECTION vs. LO FREQUENCY (L-C BPF TUNED FOR 810MHz RF FREQUENCY)

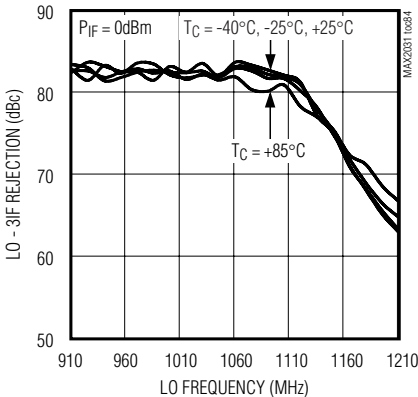

LO - 3IF REJECTION vs. LO FREQUENCY (L-C BPF TUNED FOR 810MHz RF FREQUENCY)

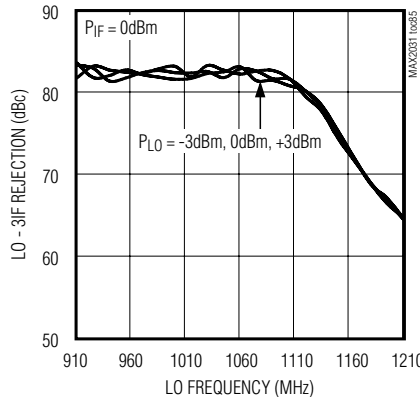

LO - 3IF REJECTION vs. LO FREQUENCY (L-C BPF TUNED FOR 810MHz RF FREQUENCY)

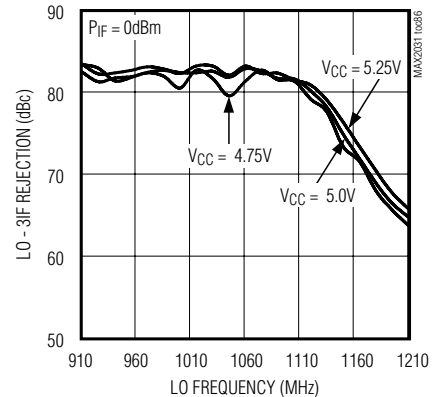

High-Linearity, 650MHz to 1000MHz Upconversion/Downconversion Mixer with LO Buffer/Switch

Typical Operating Characteristics (continued)

(Typical Application Circuit, L1 = 4.7nH, C4 = 6pF, C5 not used, VCC = 5.0V, PLO = 0dBm, PIF = 0dBm, fRF = fLO + fIF, fIF = 160MHz, TC = +25°C, unless otherwise noted.)

Upconverter Curves

LO LEAKAGE AT RF PORT vs. LO FREQUENCY (L-C BPF TUNED FOR 810MHz RF FREQUENCY)

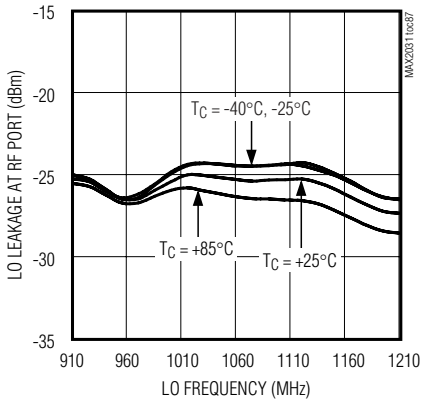

LO LEAKAGE AT RF PORT vs. LO FREQUENCY (L-C BPF TUNED FOR 810MHz RF FREQUENCY)

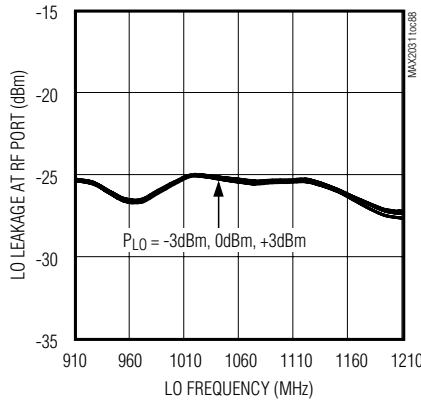

LO LEAKAGE AT RF PORT vs. LO FREQUENCY (L-C BPF TUNED FOR 810MHz RF FREQUENCY)

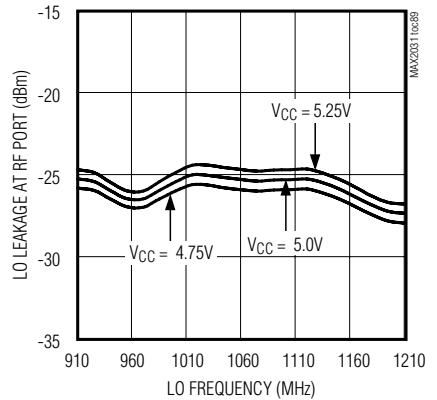

IF LEAKAGE AT RF vs. LO FREQUENCY (L-C BPF TUNED FOR 810MHz RF FREQUENCY)

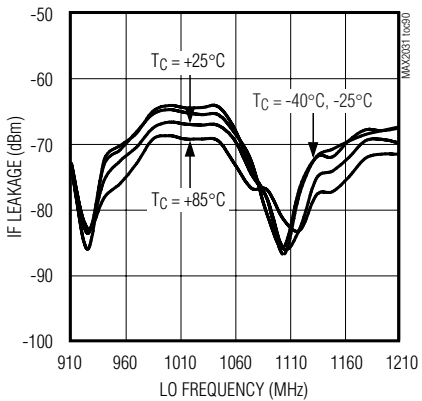

IF LEAKAGE AT RF vs. LO FREQUENCY (L-C BPF TUNED FOR 810MHz RF FREQUENCY)

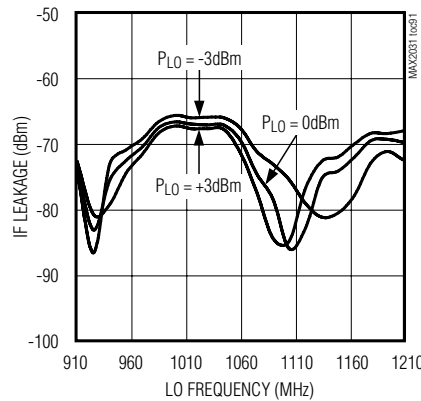

IF LEAKAGE AT RF vs. LO FREQUENCY (L-C BPF TUNED FOR 810MHz RF FREQUENCY)

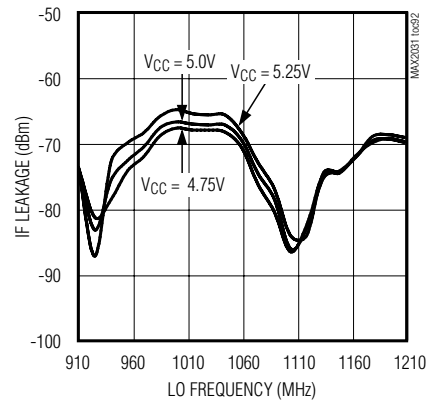

RF PORT RETURN LOSS vs. RF FREQUENCY (L-C BPF TUNED FOR 810MHz RF FREQUENCY)

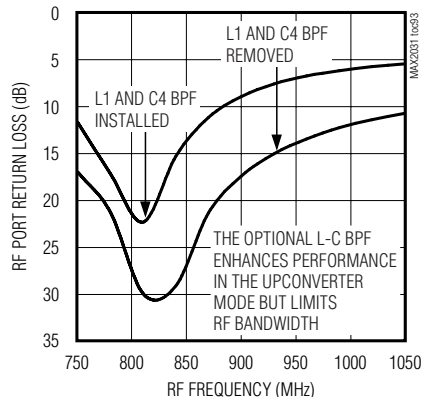

High-Linearity, 650MHz to 1000MHz Upconversion/Downconversion Mixer with LO Buffer/Switch

Pin Description

PIN	NAME	FUNCTION
1, 6, 8, 14	VCC	Power-Supply Connection. Bypass each VCC pin to GND with capacitors as shown in the <i>Typical Application Circuit</i> .
2	RF	Single-Ended 50Ω RF Input/Output. This port is internally matched and DC shorted to GND through a balun.
3	TAP	Center Tap of the Internal RF Balun. Connect to ground.
4, 5, 10, 12, 13, 16, 17, 20	GND	Ground
7	LOBIAS	Bias Resistor for Internal LO Buffer. Connect a 523Ω ±1% resistor from LOBIAS to the power supply.
9	LOSEL	Local Oscillator Select. Logic-control input for selecting LO1 or LO2.
11	LO1	Local Oscillator Input 1. Drive LOSEL low to select LO1.
15	LO2	Local Oscillator Input 2. Drive LOSEL high to select LO2.
18, 19	IF-, IF+	Differential IF Input/Outputs
—	EP	Exposed Pad. Internally connected to GND. Solder this exposed pad to a PCB pad that uses multiple ground vias to provide heat transfer out of the device into the PCB ground planes. These multiple ground vias are also required to achieve the noted RF performance.

Detailed Description

The MAX2031 can operate either as a downconverter or an upconverter mixer that provides approximately 7dB of conversion loss with a typical 7dB noise figure. IIP3 is +36dBm for both upconversion and downconversion modes. The integrated baluns and matching circuitry allow for 50Ω single-ended interfaces to the RF port and the two LO ports. The RF port can be used as an input for downconversion or an output for upconversion. A single-pole, double-throw (SPDT) switch provides 50ns switching time between the two LO inputs with 49dB of LO-to-LO isolation. Furthermore, the integrated LO buffer provides a high drive level to the mixer core, reducing the LO drive required at the MAX2031's inputs to a -3dBm to +3dBm range. The IF port incorporates a differential output for downconversion, which is ideal for providing enhanced IIP2 performance. For upconversion, the IF port is a differential input.

Specifications are guaranteed over broad frequency ranges to allow for use in cellular band WCDMA, cdmaOne™, cdma2000, and GSM 850/GSM 900 2.5G EDGE base stations. The MAX2031 is specified to operate over a 650MHz to 1000MHz RF frequency range, a 650MHz to 1250MHz LO frequency range, and a DC to 250MHz IF frequency range. Operation beyond these ranges is possible; see the *Typical Operating Characteristics* for additional details.

The MAX2031 is optimized for high-side LO injection architectures. However, the device can operate in low-

cdmaOne is a trademark of CDMA Development Group.

side LO injection applications with an extended LO range, but performance degrades as f_{LO} decreases. See the *Typical Operating Characteristics* for measurements taken with f_{LO} below 960MHz. For a pin-compatible device that has been optimized for LO frequencies below 960MHz, refer to the MAX2029.

RF Port and Balun

For using the MAX2031 as a downconverter, the RF input is internally matched to 50Ω, requiring no external matching components. A DC-blocking capacitor is required because the input is internally DC shorted to ground through the on-chip balun. For upconverter operation, the RF port is a single-ended output similarly matched to 50Ω.

LO Inputs, Buffer, and Balun

The MAX2031 is optimized for high-side LO injection architectures with a 650MHz to 1250MHz LO frequency range. For a device with a 570MHz to 900MHz LO frequency range, refer to the MAX2029. As an added feature, the MAX2031 includes an internal LO SPDT switch that can be used for frequency-hopping applications. The switch selects one of the two single-ended LO ports, allowing the external oscillator to settle on a particular frequency before it is switched in. LO switching time is typically less than 50ns, which is more than adequate for nearly all GSM applications. If frequency hopping is not employed, set the switch to either of the LO inputs. The switch is controlled by a digital input (LOSEL): logic-high selects LO2, logic-low selects LO1.

High-Linearity, 650MHz to 1000MHz Upconversion/Downconversion Mixer with LO Buffer/Switch

To avoid damage to the part, voltage MUST be applied to V_{CC} before digital logic is applied to LOSEL (see the *Absolute Maximum Ratings*). LO1 and LO2 inputs are internally matched to 50Ω, requiring an 82pF DC-blocking capacitor at each input.

A two-stage internal LO buffer allows a wide input-power range for the LO drive. All guaranteed specifications are for a -3dBm to +3dBm LO signal power. The on-chip low-loss balun, along with an LO buffer, drives the double-balanced mixer. All interfacing and matching components from the LO inputs to the IF outputs are integrated on-chip.

High-Linearity Mixer

The core of the MAX2031 is a double-balanced, high-performance passive mixer. Exceptional linearity is provided by the large LO swing from the on-chip LO buffer.

Differential IF

The MAX2031 mixer has a DC to 250MHz IF frequency range. Note that these differential ports are ideal for providing enhanced IIP2 performance. Single-ended IF applications require a 1:1 balun to transform the 50Ω differential IF impedance to 50Ω single-ended. Including the balun, the IF return loss is better than 15dB. The differential IF is used as an input port for upconverter operation. The user can use a differential IF amplifier following the mixer, but a DC block is required on both IF pins.

Applications Information

Input and Output Matching

The RF and LO inputs are internally matched to 50Ω. No matching components are required. As a downconverter, the return loss at the RF port is typically better than 15dB over the entire input range (650MHz to 1000MHz), and return loss at the LO ports are typically 15dB (960MHz to 1180MHz). RF and LO inputs require only DC-blocking capacitors for interfacing (see Table 1).

An optional L-C bandpass filter (BPF) can be installed at the RF port to improve upconverter performance. See the *Typical Application Circuit* and *Typical Operating Characteristics* for upconverter operation with an L-C BPF tuned for 810MHz RF frequency. Performance can be optimized at other frequencies by choosing different values for L1 and C4. Removing L1 and C4 altogether results in a broader match, but performance degrades. Contact factory for details.

The IF output impedance is 50Ω (differential). For evaluation, an external low-loss 1:1 (impedance ratio) balun transforms this impedance to a 50Ω single-ended output (see the *Typical Application Circuit*).

Bias Resistor

Bias current for the LO buffer is optimized by fine tuning resistor R1. If reduced current is required at the

Table 1. Typical Application Circuit Component List

DESIGNATION	QTY	DESCRIPTION	SUPPLIER
C1	1	82pF microwave capacitor (0603). Use for 800MHz/900MHz cellular band applications.	Murata Electronics North America, Inc.
		7pF microwave capacitor (0603). Use for 700MHz band applications	
C2, C7, C8, C10, C11, C12	6	82pF microwave capacitors (0603)	Murata Electronics North America, Inc.
C3, C6, C9	3	0.01μF microwave capacitors (0603)	Murata Electronics North America, Inc.
C4*	1	6pF microwave capacitor (0603)	—
C5**	1	2pF microwave capacitor (0603). Use for 800MHz/900MHz cellular band applications.	Murata Electronics North America, Inc.
		3.3pF microwave capacitor (0603). Use for 700MHz band applications	
L1*	1	4.7nH inductor (0603)	—
R1	1	523Ω ±1% resistor (0603)	Digi-Key Corp.
T1	1	MABAES0029 1:1 transformer (50:50)	M/A-Com, Inc.
U1	1	MAX2031 IC (20 TQFN)	Maxim Integrated Products, Inc.

*C4 and L1 installed only when mixer is used as an upconverter.

**C5 installed only when mixer is used as a downconverter.

High-Linearity, 650MHz to 1000MHz Upconversion/ Downconversion Mixer with LO Buffer/Switch

expense of performance, contact the factory for details. If the $\pm 1\%$ bias resistor values are not readily available, substitute standard $\pm 5\%$ values.

Layout Considerations

A properly designed PC board is an essential part of any RF/microwave circuit. Keep RF signal lines as short as possible to reduce losses, radiation, and inductance. For the best performance, route the ground-pin traces directly to the exposed pad under the package. The PC board exposed pad **MUST** be connected to the ground plane of the PC board. It is suggested that multiple vias be used to connect this pad to the lower-level ground planes. This method provides a good RF/thermal conduction path for the device. Solder the exposed pad on the bottom of the device package to the PC board. The MAX2031 evaluation kit can be used as a reference for board layout. Gerber files are available upon request at www.maxim-ic.com.

Power-Supply Bypassing

Proper voltage-supply bypassing is essential for high-frequency circuit stability. Bypass each VCC pin with the capacitors shown in the *Typical Application Circuit*. See Table 1.

Exposed Pad RF/Thermal Considerations

The exposed pad (EP) of the MAX2031's 20-pin thin QFN-EP package provides a low-thermal-resistance path to the die. It is important that the PC board on which the MAX2031 is mounted be designed to conduct heat from the EP. In addition, provide the EP with a low-inductance path to electrical ground. The EP **MUST** be soldered to a ground plane on the PC board, either directly or through an array of plated via holes.

High-Linearity, 650MHz to 1000MHz Upconversion/ Downconversion Mixer with LO Buffer/Switch

Typical Application Circuit

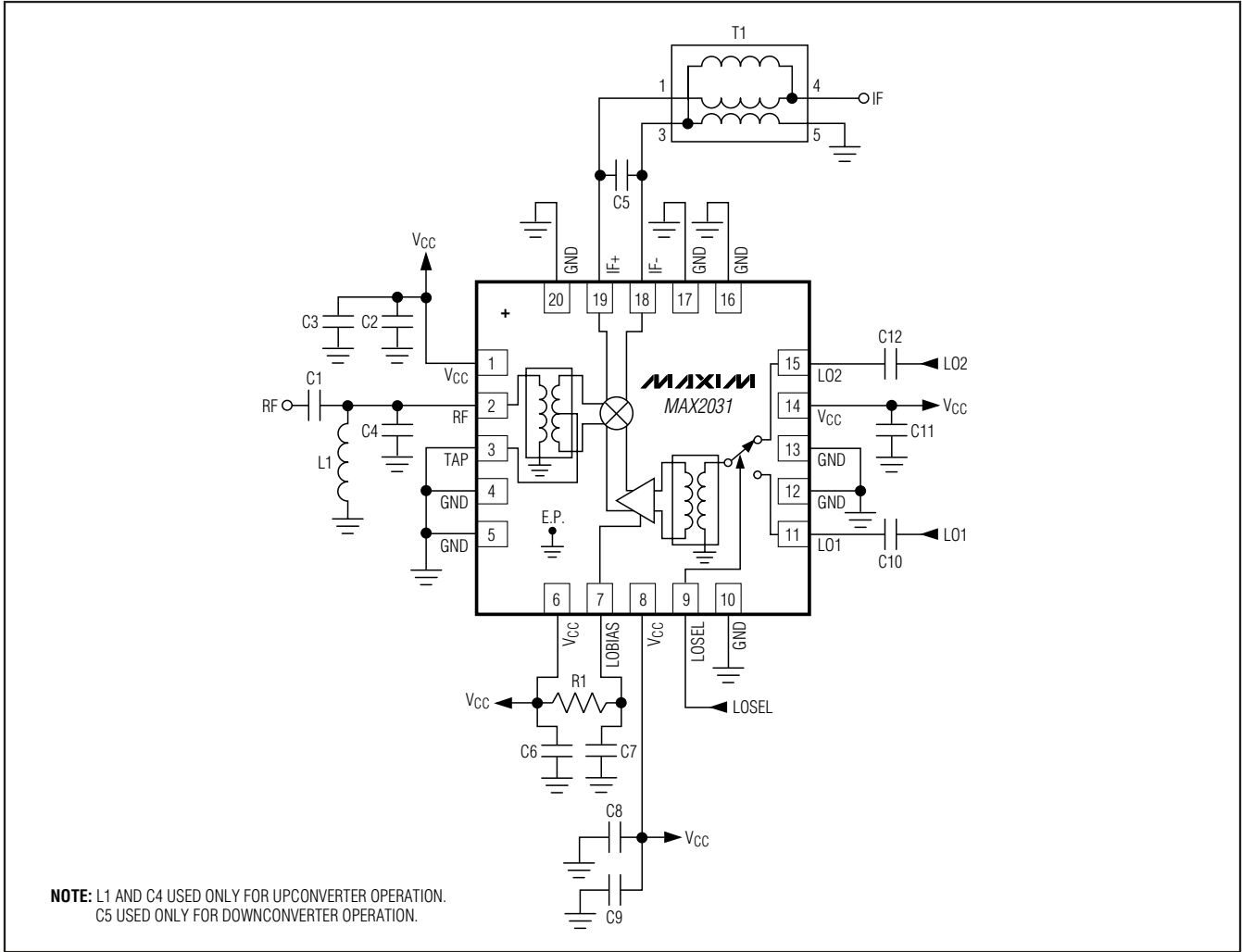

Chip Information

PROCESS: SiGe BiCMOS

Package Information

For the latest package outline information and land patterns, go to www.maxim-ic.com/packages.

PACKAGE TYPE	PACKAGE CODE	DOCUMENT NO.
20 Thin QFN-EP	T2055+3	21-0140

High-Linearity, 650MHz to 1000MHz Upconversion/ Downconversion Mixer with LO Buffer/Switch

Revision History

REVISION NUMBER	REVISION DATE	DESCRIPTION	PAGES CHANGED
0	7/05	Initial release	—
1	6/09	Added new <i>Electrical Characteristics</i> tables and <i>Typical Operating Characteristics</i>	1–16

Maxim cannot assume responsibility for use of any circuitry other than circuitry entirely embodied in a Maxim product. No circuit patent licenses are implied. Maxim reserves the right to change the circuitry and specifications without notice at any time.

20 _____ **Maxim Integrated Products, 120 San Gabriel Drive, Sunnyvale, CA 94086 408-737-7600**