

Full - Bridge
NPT & Trench + Field Stop® IGBT
Power module

Trench & Field Stop® IGBT Q1, Q3:
 $V_{CES} = 1200V ; I_C = 15A @ T_c = 80^\circ C$

Fast NPT IGBT Q2, Q4:
 $V_{CES} = 1200V ; I_C = 15A @ T_c = 80^\circ C$

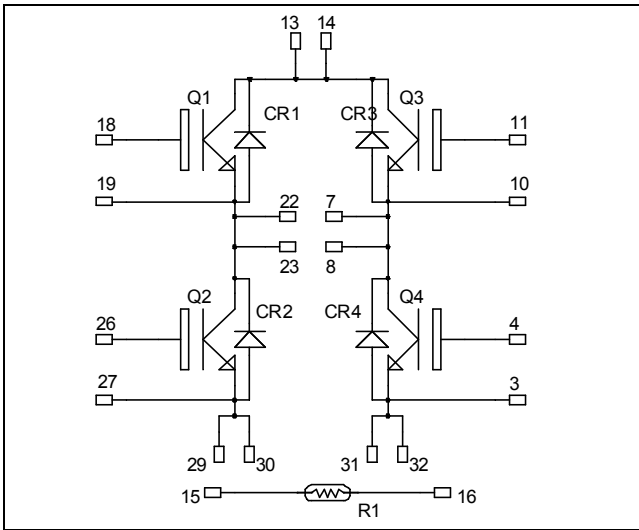

Top switches : Trench + Field Stop IGBT®
Bottom switches : FAST NPT IGBT®

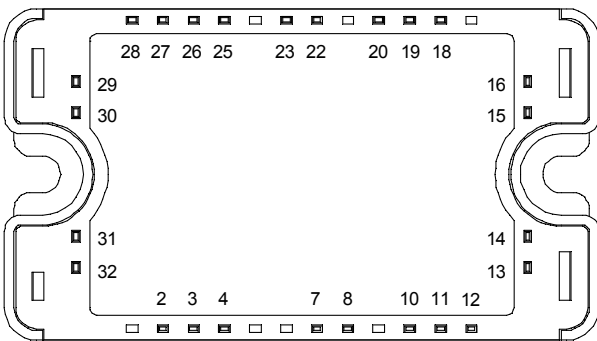

All multiple inputs and outputs must be shorted together
13/14 ; 15/16 ; 26/27 ; 31/32

Application

- Solar converter

Features

- **Q2, Q4 (FAST Non Punch Through (NPT) IGBT)**
 - Switching frequency up to 50 kHz
 - RBSOA & SCSOA rated
 - Low tail current
- **Q1, Q3 (Trench & Field Stop IGBT®)**
 - Low voltage drop
 - Switching frequency up to 20 kHz
 - RBSOA & SCSOA rated
 - Low tail current

- Kelvin emitter for easy drive
- Very low stray inductance
- High level of integration
- Internal thermistor for temperature monitoring

Benefits

- Optimized conduction & switching losses
- Direct mounting to heatsink (isolated package)
- Low junction to case thermal resistance
- Solderable terminals both for power and signal for easy PCB mounting
- Low profile
- Easy paralleling due to positive T_C of V_{CESat}
- RoHS Compliant

CAUTION: These Devices are sensitive to Electrostatic Discharge. Proper Handling Procedures Should Be Followed. See application note APT0502 on www.microsemi.com

All ratings @ $T_j = 25^\circ\text{C}$ unless otherwise specified

1. Top switches
1.1 Top Trench + Field Stop IGBT[®] characteristics
Absolute maximum ratings

Symbol	Parameter	Max ratings	Unit
V_{CES}	Collector - Emitter Breakdown Voltage	1200	V
I_C	Continuous Collector Current	$T_C = 25^\circ\text{C}$	25
		$T_C = 80^\circ\text{C}$	15
I_{CM}	Pulsed Collector Current	$T_C = 25^\circ\text{C}$	30
V_{GE}	Gate - Emitter Voltage	± 20	V
P_D	Maximum Power Dissipation	$T_C = 25^\circ\text{C}$	115
RBSOA	Reverse Bias Safe Operation Area	$T_j = 125^\circ\text{C}$	30A @ 1150V

Electrical Characteristics

Symbol	Characteristic	Test Conditions	Min	Typ	Max	Unit
I_{CES}	Zero Gate Voltage Collector Current	$V_{GE} = 0\text{V}, V_{CE} = 1200\text{V}$			250	μA
$V_{CE(sat)}$	Collector Emitter Saturation Voltage	$V_{GE} = 15\text{V}$		1.7	2.1	V
		$I_C = 15\text{A}$	$T_j = 25^\circ\text{C}$			
				2.0		
$V_{GE(th)}$	Gate Threshold Voltage	$V_{GE} = V_{CE}, I_C = 0.6\text{mA}$	5.0	5.8	6.5	V
I_{GES}	Gate - Emitter Leakage Current	$V_{GE} = 20\text{V}, V_{CE} = 0\text{V}$			400	nA

Dynamic Characteristics

Symbol	Characteristic	Test Conditions	Min	Typ	Max	Unit
C_{ies}	Input Capacitance	$V_{GE} = 0\text{V}, V_{CE} = 25\text{V}$ $f = 1\text{MHz}$		1100		pF
C_{res}	Reverse Transfer Capacitance			90		
$T_{d(on)}$	Turn-on Delay Time	Inductive Switching (25°C) $V_{GE} = \pm 15\text{V}$ $V_{Bus} = 600\text{V}$ $I_C = 15\text{A}$ $R_G = 62\Omega$		90		ns
T_r	Rise Time			30		
$T_{d(off)}$	Turn-off Delay Time			420		
T_f	Fall Time			80		
$T_{d(on)}$	Turn-on Delay Time	Inductive Switching (125°C) $V_{GE} = \pm 15\text{V}$ $V_{Bus} = 600\text{V}$ $I_C = 15\text{A}$ $R_G = 62\Omega$		90		ns
T_r	Rise Time			30		
$T_{d(off)}$	Turn-off Delay Time			520		
T_f	Fall Time			120		
E_{on}	Turn-on Switching Energy	$V_{GE} = \pm 15\text{V}$ $V_{Bus} = 600\text{V}$ $I_C = 15\text{A}$ $R_G = 62\Omega$	$T_j = 25^\circ\text{C}$	1.15		mJ
			$T_j = 125^\circ\text{C}$	1.5		
E_{off}	Turn-off Switching Energy		$T_j = 25^\circ\text{C}$	1.15		
			$T_j = 125^\circ\text{C}$	1.8		
R_{thJC}	Junction to Case Thermal resistance				1.3	$^\circ\text{C/W}$

1.2 Top fast diode characteristics

<i>Symbol</i>	<i>Characteristic</i>	<i>Test Conditions</i>		<i>Min</i>	<i>Typ</i>	<i>Max</i>	<i>Unit</i>
V _{RRM}	Maximum Peak Repetitive Reverse Voltage			1200			V
I _{RM}	Maximum Reverse Leakage Current	V _R =1200V	T _j = 25°C			100	μA
			T _j = 125°C			500	
I _F	DC Forward Current	T _c = 80°C			15		A
V _F	Diode Forward Voltage	I _F = 15A			2.8	3.3	V
		I _F = 30A			3.4		
		I _F = 15A	T _j = 125°C		2.4		
t _{rr}	Reverse Recovery Time	I _F = 15A V _R = 800V di/dt = 200A/μs	T _j = 25°C		240		ns
			T _j = 125°C		290		
Q _{rr}	Reverse Recovery Charge	I _F = 15A V _R = 800V di/dt = 200A/μs	T _j = 25°C		260		nC
			T _j = 125°C		960		
R _{thJC}	Junction to Case Thermal resistance					2	°C/W

2. Bottom switches
2.1 Bottom Fast NPT IGBT characteristics
Absolute maximum ratings

<i>Symbol</i>	<i>Parameter</i>	<i>Max ratings</i>		<i>Unit</i>
V _{CES}	Collector - Emitter Breakdown Voltage	1200		V
I _C	Continuous Collector Current	T _C = 25°C	25	A
		T _C = 80°C	15	
I _{CM}	Pulsed Collector Current	T _C = 25°C	60	
V _{GE}	Gate - Emitter Voltage	±20		V
P _D	Maximum Power Dissipation	T _C = 25°C	140	W
RBSOA	Reverse Bias Safe Operating Area	T _j = 125°C	30A@1150V	

Electrical Characteristics

<i>Symbol</i>	<i>Characteristic</i>	<i>Test Conditions</i>		<i>Min</i>	<i>Typ</i>	<i>Max</i>	<i>Unit</i>
I _{CES}	Zero Gate Voltage Collector Current	V _{GE} = 0V V _{CE} = 1200V	T _j = 25°C			250	μA
			T _j = 125°C			500	
V _{CE(sat)}	Collector Emitter Saturation Voltage	V _{GE} = 15V I _C = 15A	T _j = 25°C	2.5	3.2	3.7	V
			T _j = 125°C		4.0		
V _{GE(th)}	Gate Threshold Voltage	V _{GE} = V _{CE} , I _C = 1mA		4		6	V
I _{GES}	Gate - Emitter Leakage Current	V _{GE} = 20V, V _{CE} = 0V				400	nA

Dynamic Characteristics

Symbol	Characteristic	Test Conditions	Min	Typ	Max	Unit
C _{ies}	Input Capacitance	V _{GE} = 0V		1000		pF
C _{oes}	Output Capacitance	V _{CE} = 25V		150		
C _{res}	Reverse Transfer Capacitance	f = 1MHz		70		
Q _g	Total gate Charge	V _{GE} = 15V		99		nC
Q _{ge}	Gate – Emitter Charge	V _{Bus} = 300V		10		
Q _{gc}	Gate – Collector Charge	I _C = 15A		70		
T _{d(on)}	Turn-on Delay Time	Inductive Switching (25°C) V _{GE} = 15V V _{Bus} = 400V I _C = 15A R _G = 33Ω		60		ns
T _r	Rise Time			50		
T _{d(off)}	Turn-off Delay Time			315		
T _f	Fall Time			30		
T _{d(on)}	Turn-on Delay Time	Inductive Switching (125°C) V _{GE} = 15V V _{Bus} = 400V I _C = 15A R _G = 33Ω		60		ns
T _r	Rise Time			50		
T _{d(off)}	Turn-off Delay Time			356		
T _f	Fall Time			40		
E _{on}	Turn-on Switching Energy	V _{GE} = 15V V _{Bus} = 400V I _C = 15A R _G = 33Ω	T _j = 125°C	2		mJ
E _{off}	Turn-off Switching Energy		T _j = 125°C	1		
R _{thJC}	Junction to Case Thermal resistance				0.9	°C/W

2.2 Bottom diode characteristics

Symbol	Characteristic	Test Conditions	Min	Typ	Max	Unit
V _{RRM}	Maximum Peak Repetitive Reverse Voltage		1200			V
I _{RM}	Maximum Reverse Leakage Current	V _R = 1200V	T _j = 25°C		100	μA
			T _j = 125°C		500	
I _F	DC Forward Current		T _c = 80°C	15		A
V _F	Diode Forward Voltage	I _F = 15A		2.8	3.3	V
		I _F = 30A		3.4		
		I _F = 15A	T _j = 125°C	2.4		
t _{rr}	Reverse Recovery Time	I _F = 15A V _R = 800V di/dt = 200A/μs	T _j = 25°C	240		ns
			T _j = 125°C	290		
Q _{rr}	Reverse Recovery Charge	I _F = 15A V _R = 800V di/dt = 200A/μs	T _j = 25°C	260		nC
			T _j = 125°C	960		
R _{thJC}	Junction to Case Thermal resistance				2	°C/W

3. Temperature sensor

NTC (see application note APT0406 on www.microsemi.com for more information).

Symbol	Characteristic	Min	Typ	Max	Unit
R ₂₅	Resistance @ 25°C		50		kΩ
B _{25/85}	T ₂₅ = 298.15 K		3952		K

$$R_T = \frac{R_{25}}{\exp \left[B_{25/85} \left(\frac{1}{T_{25}} - \frac{1}{T} \right) \right]}$$

T: Thermistor temperature
 R_T: Thermistor value at T

4. Package characteristics

Symbol	Characteristic	Min	Typ	Max	Unit	
V _{ISOL}	RMS Isolation Voltage, any terminal to case t=1 min, I _{isol} <1mA, 50/60Hz	2500			V	
T _J	Operating junction temperature range	-40		150*	°C	
T _{STG}	Storage Temperature Range	-40		125		
T _C	Operating Case Temperature	-40		100		
Torque	Mounting torque	To heatsink	M4	2.5	4.7	N.m
Wt	Package Weight				110	g

T_j=175°C for Trench & Field Stop IGBT

5. SP3 Package outline (dimensions in mm)

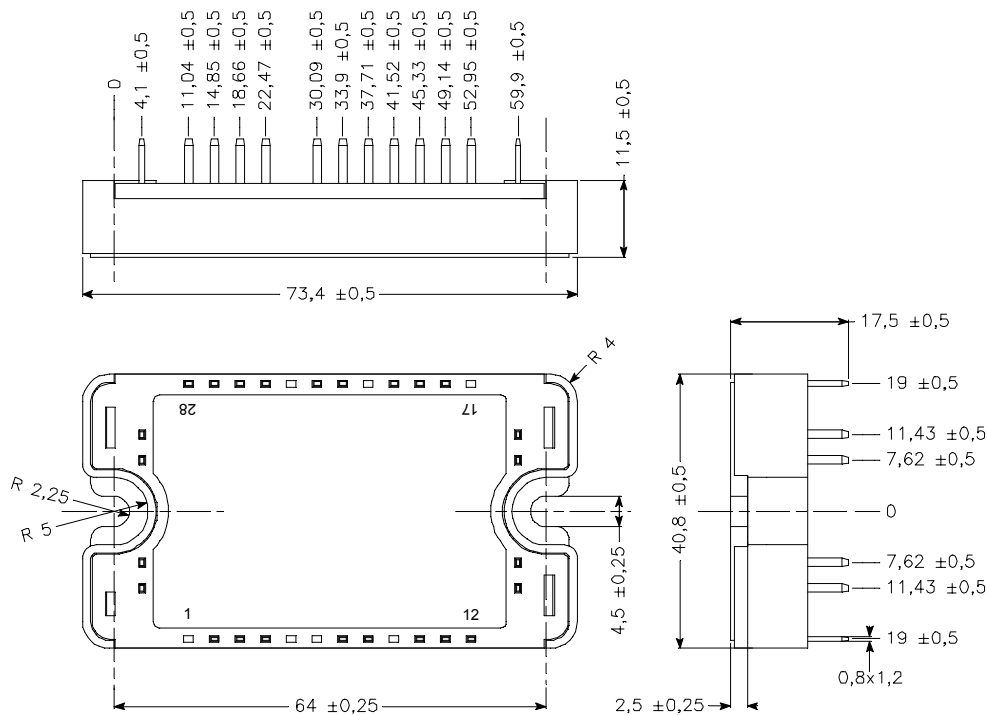

See application note 1901 - Mounting Instructions for SP3 Power Modules on www.microsemi.com

6. Top switches curves

6.1 Top Trench + Field Stop IGBT[®] typical performance curves

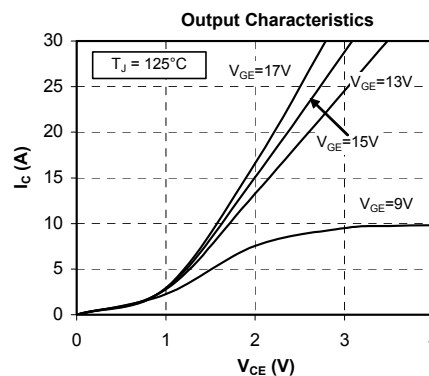
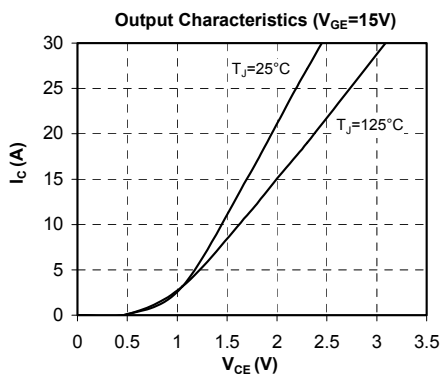

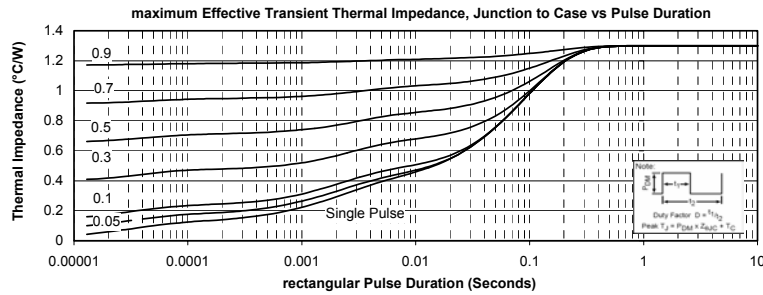
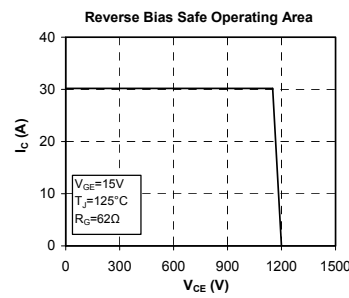
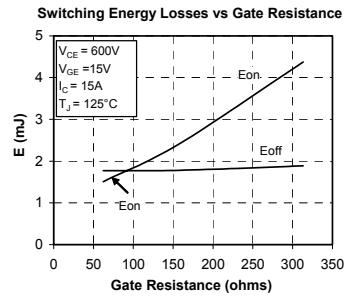
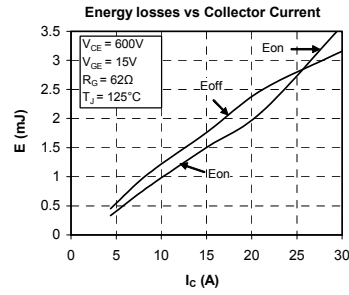
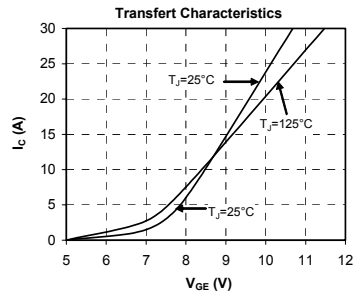

6.2 Top Fast diode typical performance curves

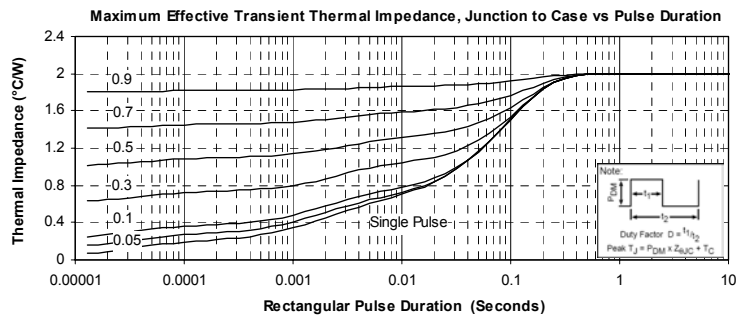
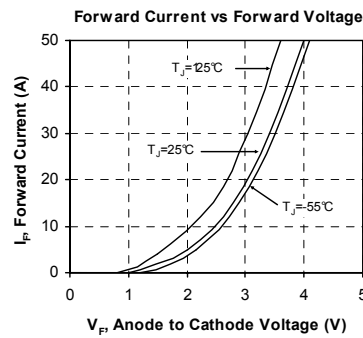

7. Bottom switches curves

7.1 Bottom fast NPT IGBT typical performance curves

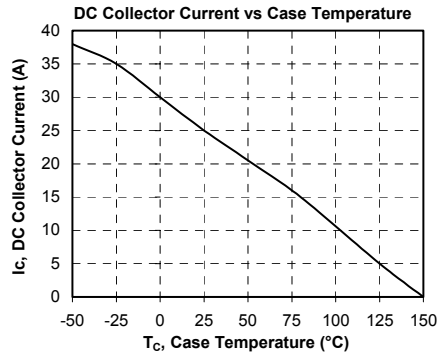
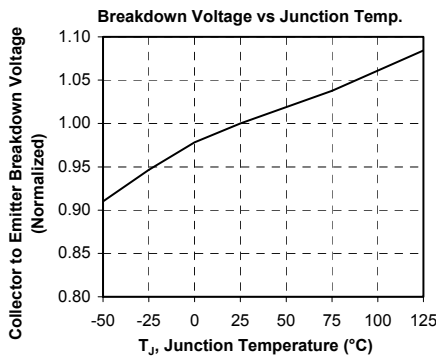
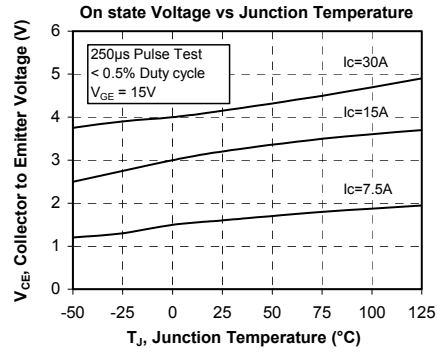
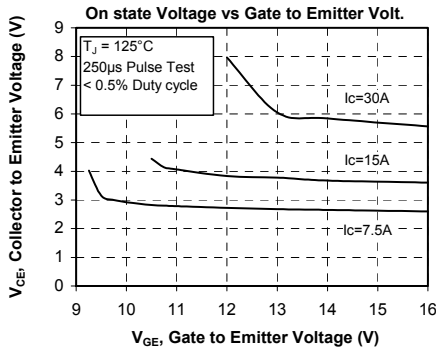
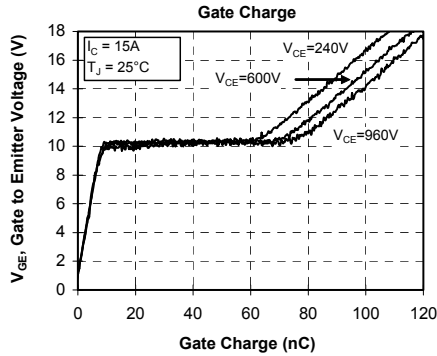
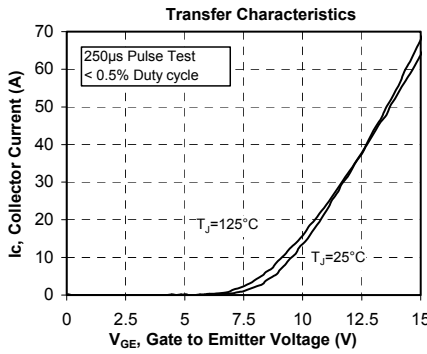
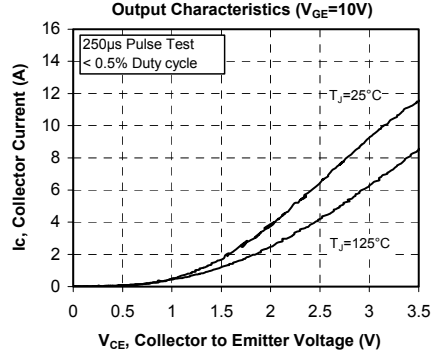
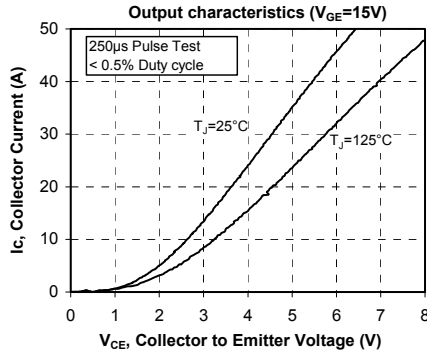

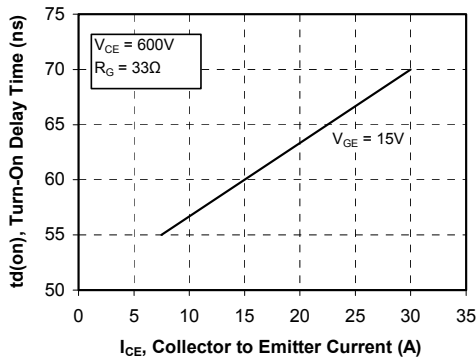
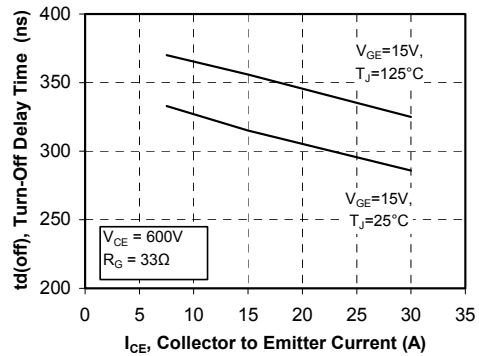
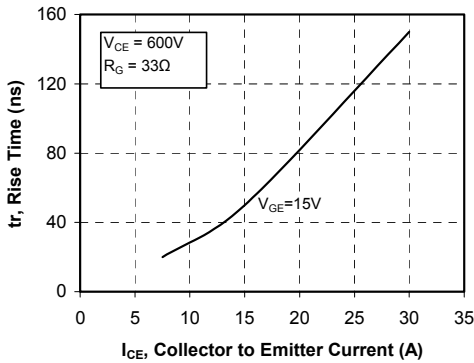
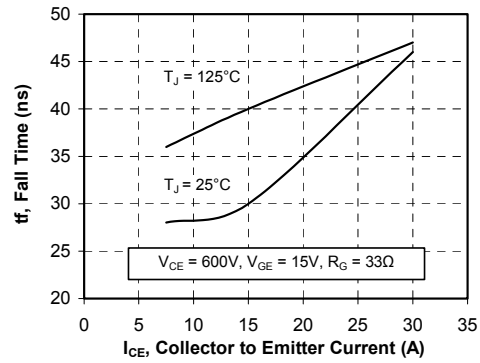
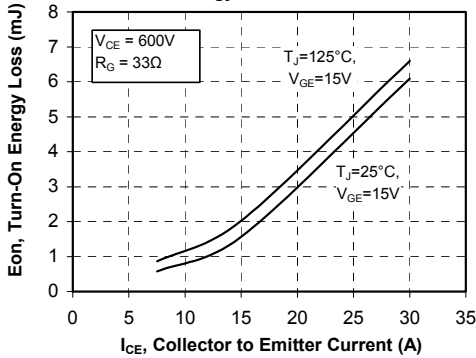
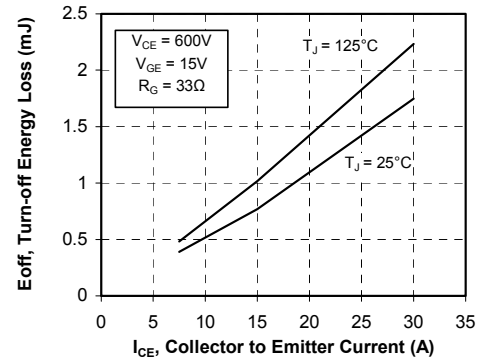
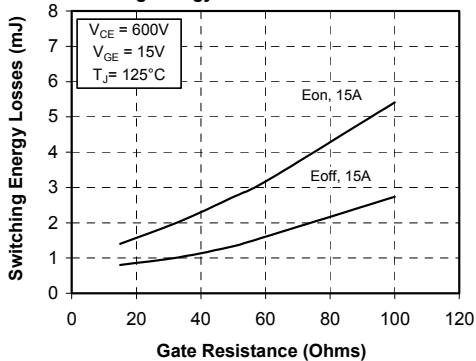
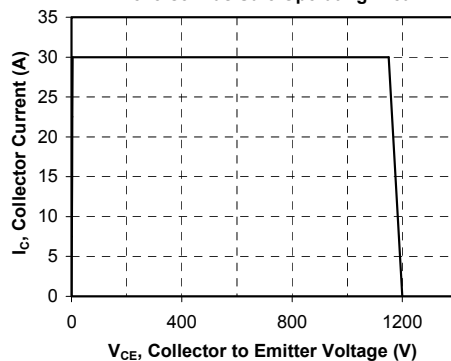
Turn-On Delay Time vs Collector Current

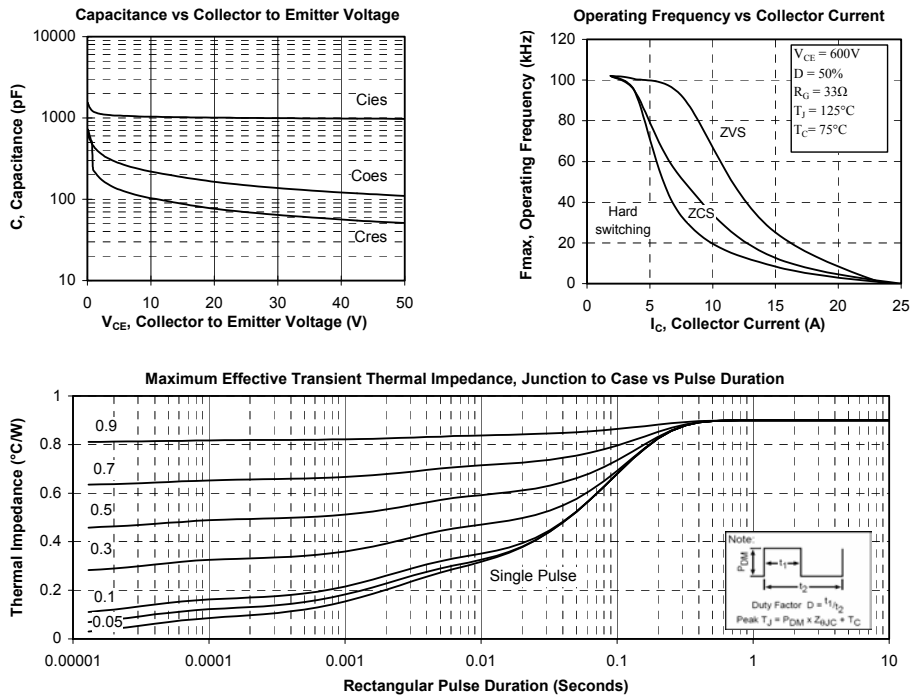
Turn-Off Delay Time vs Collector Current

Current Rise Time vs Collector Current

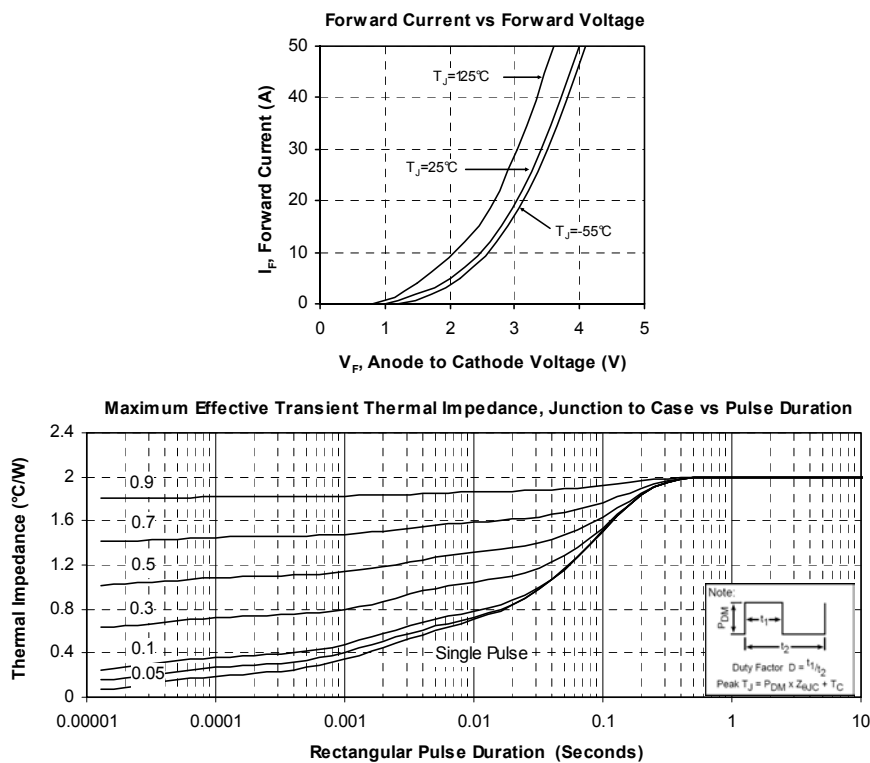
Current Fall Time vs Collector Current

Turn-On Energy Loss vs Collector Current

Turn-Off Energy Loss vs Collector Current

Switching Energy Losses vs Gate Resistance

Reverse Bias Safe Operating Area



7.2 Bottom diode typical performance curves



Microsemi reserves the right to change, without notice, the specifications and information contained herein

Microsemi's products are covered by one or more of U.S. patents 4,895,810 5,045,903 5,089,434 5,182,234 5,019,522 5,262,336 6,503,786 5,256,583 4,748,103 5,283,202 5,231,474 5,434,095 5,528,058 and foreign patents. U.S. and Foreign patents pending. All Rights Reserved.