

INTERNATIONAL RECTIFIER 

HEXFET® TRANSISTORS * JANTXV2N6756

JEDEC REGISTERED
N-CHANNEL
POWER MOSFETS

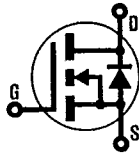

* JANTX2N6756

2N6756

2N6755

*QUALIFIED TO MIL-S-19500/542

100 Volt, 0.18 Ohm HEXFET

The HEXFET® technology is the key to International Rectifier's advanced line of power MOSFET transistors. The efficient geometry and unique processing of the HEXFET design achieve very low on-state resistance combined with high transconductance and great device ruggedness.

The HEXFET transistors also feature all of the well established advantages of MOSFETs such as voltage control, very fast switching, ease of paralleling, and temperature stability of the electrical parameters.

They are well suited for applications such as switching power supplies, motor controls, inverters, choppers, audio amplifiers, and high energy pulse circuits.

Features:

- Fast Switching
- Low Drive Current
- Ease of Paralleling
- Excellent Temperature Stability

Product Summary

Part Number	V _{DS}	R _{DS(on)}	I _D
2N6755	60V	0.25Ω	12A
2N6756	100V	0.18Ω	14A

CASE STYLE AND DIMENSIONS

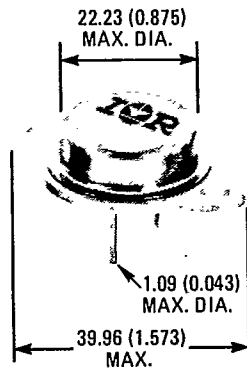

ACTUAL SIZE

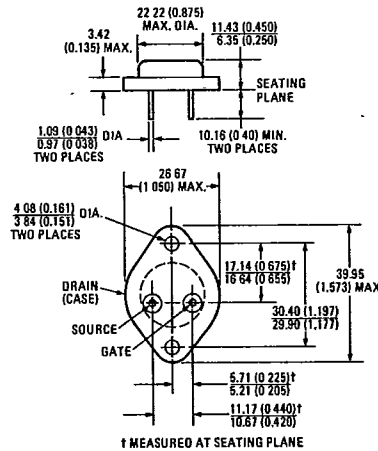

Conforms to JEDEC Outline TO-204AA (TO-3)
Dimensions in Millimeters and (Inches)

JANTXV, JANTX-, 2N6756 and 2N6755 Devices

T-39-11

INTERNATIONAL RECTIFIER

Absolute Maximum Ratings

Parameter	2N6755	2N6756	Units
V _{DS} Drain - Source Voltage	60*	100*	V
V _{DGR} Drain - Gate Voltage (R _{GS} = 1 MΩ)	60*	100*	V
I _D @ T _C = 25°C Continuous Drain Current	12*	14*	A
I _D @ T _C = 100°C Continuous Drain Current	8.0*	9.0*	A
I _{DM} Pulsed Drain Current	25	30	A
V _{GS} Gate - Source Voltage	±20*		V
P _D @ T _C = 25°C Max. Power Dissipation	75* (See Fig. 11)		W
P _D @ T _C = 100°C Max. Power Dissipation	30* (See Fig. 11)		W
Linear Derating Factor	0.6* (See Fig. 11)		W/K ②
I _{LM} Inductive Current, Clamped	(See Fig. 1 and 2) L = 100 μH 25 30		A
T _J Operating and Storage Temperature Range	-55* to 150*		°C
T _{stg} Lead Temperature	300* (0.063 in. (1.6mm) from case for 10s)		°C

Electrical Characteristics @ T_C = 25°C (Unless Otherwise Specified)

Parameter	Type	Min.	Typ.	Max.	Units	Test Conditions
BV _{DSS} Drain - Source Breakdown Voltage	2N6755	60	-	-	V	V _{GS} = 0 I _D = 1.0 mA
	2N6756	100	-	-	V	
V _{GS(th)} Gate Threshold Voltage	ALL	2.0*	-	4.0*	V	V _{DS} = V _{GS} , I _D = 1 mA
I _{GSSF} Gate - Body Leakage Forward	ALL	-	-	100*	nA	V _{GS} = 20V
I _{GSSR} Gate - Body Leakage Reverse	ALL	-	-	100*	nA	V _{GS} = -20V
I _{DSS} Zero Gate Voltage Drain Current	ALL	-	0.1	1.0*	mA	V _{DS} = Max. Rating, V _{GS} = 0
		-	0.2	4.0*	mA	V _{DS} = Max. Rating, V _{GS} = 0, T _C = 125°C
V _{DS(on)} Static Drain-Source On-State Voltage ①	2N6755	-	-	3.0*	V	V _{GS} = 10V, I _D = 12A
	2N6756	-	-	2.52*	V	V _{GS} = 10V, I _D = 14A
R _{DS(on)} Static Drain-Source On-State Resistance ①	2N6755	-	0.20	0.25*	Ω	V _{GS} = 10V, I _D = 8A
	2N6756	-	0.14	0.18*	Ω	V _{GS} = 10V, I _D = 9A
R _{DS(on)} Static Drain-Source On-State Resistance ①	2N6755	-	-	0.45*	Ω	V _{GS} = 10V, I _D = 8A, T _C = 125°C
	2N6756	-	-	0.33*	Ω	V _{GS} = 10V, I _D = 9A, T _C = 125°C
g _{fs} Forward Transconductance ①	ALL	4.0*	5.5	12.0*	S (Ω)	V _{DS} = 15V, I _D = 9A
C _{iss} Input Capacitance	ALL	350*	600	800*	pF	V _{GS} = 0, V _{DS} = 25V, f = 1.0 MHz
C _{oss} Output Capacitance	ALL	150*	300	500*	pF	See Fig. 10
C _{rss} Reverse Transfer Capacitance	ALL	50*	100	150*	pF	
t _{d(on)} Turn-On Delay Time	ALL	-	-	30*	ns	V _{DD} ≅ 36V, I _D = 9A, Z _o = 15Ω (See Figs. 13 and 14)
t _r Rise Time	ALL	-	-	75*	ns	
t _{d(off)} Turn-Off Delay Time	ALL	-	-	40*	ns	(MOSFET switching times are essentially independent of operating temperature.)
t _f Fall Time	ALL	-	-	45*	ns	

Thermal Resistance

R _{thJC} Junction-to-Case	ALL	-	-	1.67*	K/W ②	
R _{thCS} Case-to-Sink	ALL	-	0.1	-	K/W ②	Mounting surface flat, smooth, and greased.
R _{thJA} Junction-to-Ambient	ALL	-	-	30	K/W ②	Typical socket mount

Body-Drain Diode Ratings and Characteristics

I _S Continuous Source Current (Body Diode)	2N6755	-	-	12*	A	Modified MOSFET symbol showing the integral reverse P-N junction rectifier. 
	2N6756	-	-	14*	A	
I _{SM} Pulsed Source Current (Body Diode)	2N6755	-	-	25	A	
	2N6756	-	-	30	A	
V _{SD} Diode Forward Voltage ①	2N6755	0.85*	-	1.7*	V	T _C = 25°C, I _S = 12A, V _{GS} = 0
	2N6756	0.90*	-	1.8*	V	T _C = 25°C, I _S = 14A, V _{GS} = 0
t _{rr} Reverse Recovery Time	ALL	-	300	-	ns	T _J = 150°C, I _F = I _{SM} , dI _F /dt = 100 A/μs
Q _{RR} Reverse Recovered Charge	ALL	-	4.0	-	μC	T _J = 150°C, I _F = I _{SM} , dI _F /dt = 100 A/μs

*JEDEC registered values. ① Pulse Test: Pulse Width ≤ 300 μsec, Duty Cycle ≤ 2%

② KW = °C/W
W/K = W/°C

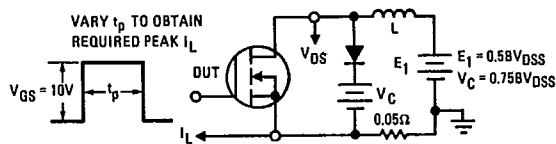

Fig. 1 - Clamped Inductive Test Circuit

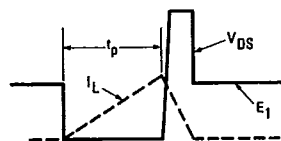

Fig. 2 - Clamped Inductive Waveforms

T-39-11

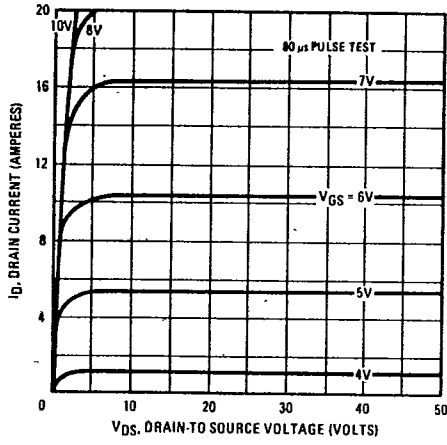

Fig. 3 - Typical Output Characteristics

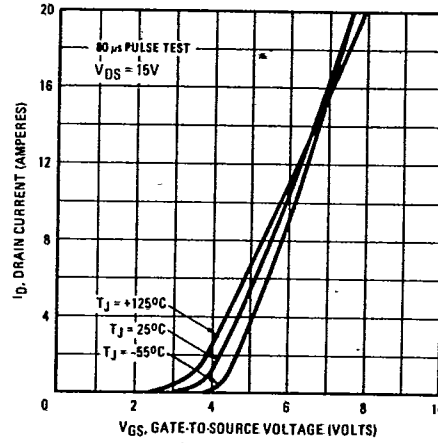

Fig. 4 - Typical Transfer Characteristics

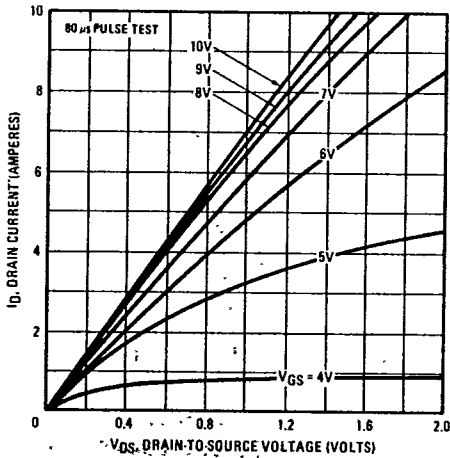

Fig. 5 - Typical Saturation Characteristics (2N6755)

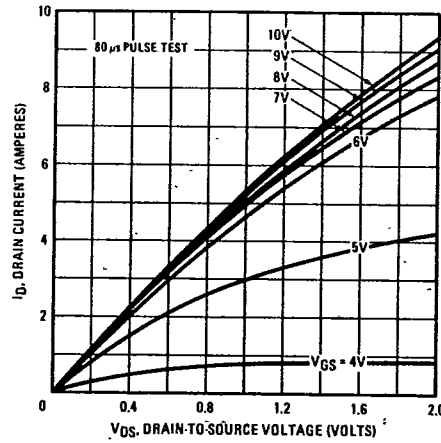

Fig. 6 - Typical Saturation Characteristics (2N6756)

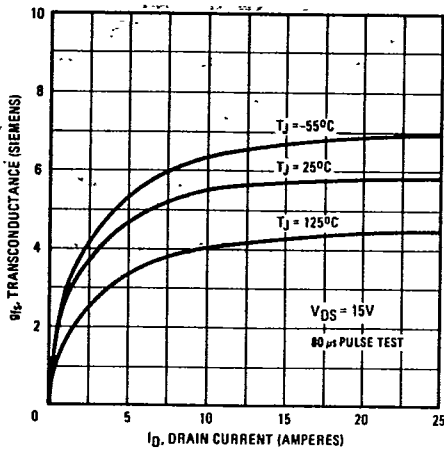

Fig. 7 - Typical Transconductance Vs. Drain Current

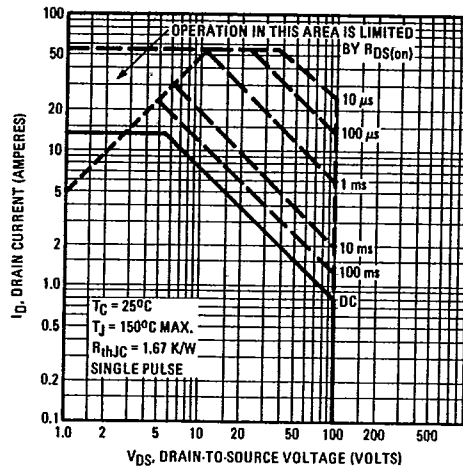

Fig. 8 - Maximum Safe Operating Area

T0-3

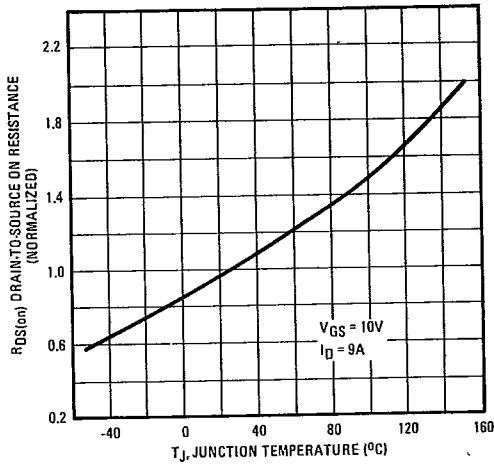

Fig. 9 - Normalized Typical On-Resistance Vs. Temperature

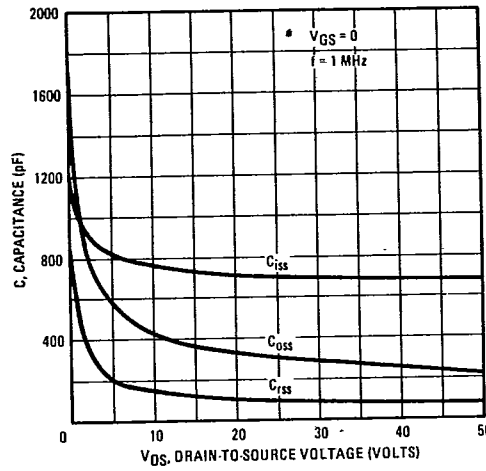

Fig. 10 - Typical Capacitance Vs. Drain-to-Source Voltage

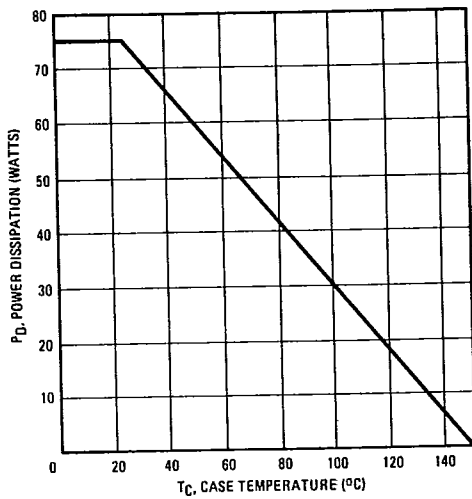

Fig. 11 - Power Vs. Temperature Derating Curve

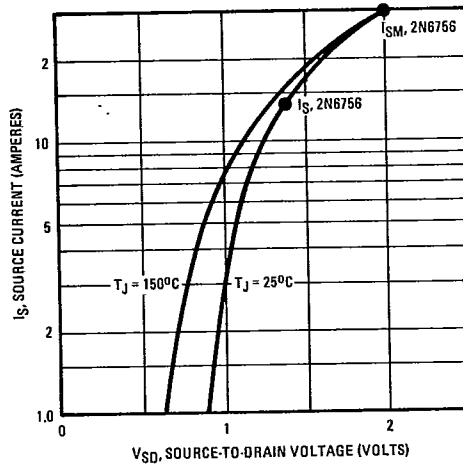

Fig. 12 - Typical Body-Drain Diode Forward Voltage

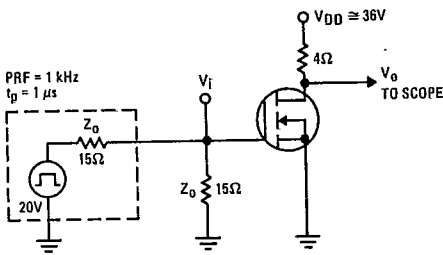

Fig. 13 - Switching Time Test Circuit

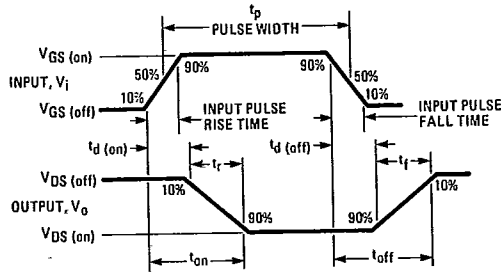

Fig. 14 - Switching Time Waveforms