

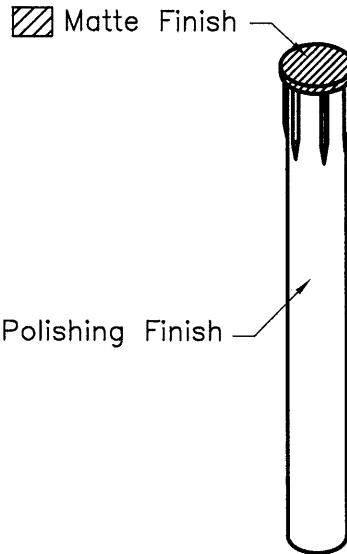

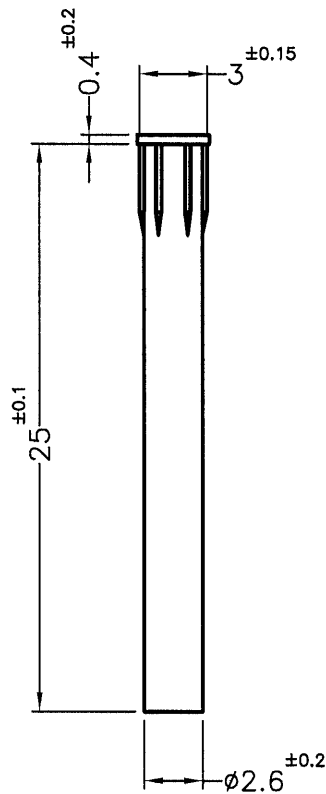

| REVISIONS |             |      |    |
|-----------|-------------|------|----|
| REV       | DESCRIPTION | DATE | BY |
|           |             |      |    |
|           |             |      |    |

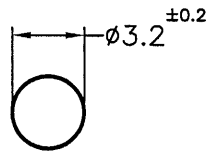
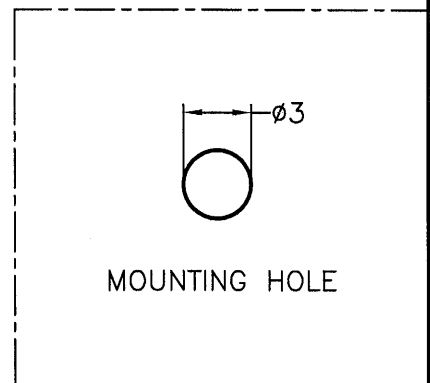

NOTE:MADE OF EQUIVALENT MATERIAL.  
均可使用同等材質.



DELTA P/N:3252658300

|  |                |      |                                      |  |   |  |   |
|--|----------------|------|--------------------------------------|--|---|--|---|
|  <p>康揚企業股份有限公司<br/>KANG YANG HARDWARE ENTERPRISE CO., LTD.<br/>康揚塑膠(東莞)有限公司<br/>KANG YANG PLASTIC(DONG GUAN) CO., LTD.<br/>康哲電腦配件(吳江)有限公司<br/>KANG CHE COMPUTER COMPONENTS(WUJIANG) CO., LTD.</p> | TITLE          |      | LIGHT PIPE                           |  | SPEC. DWG.  |  |   |
|  | MATERIAL       |      | PC UL94V-0                           |  | DATE  |  | 2014.10.03  |
|  | FINISH         |      | SEE ABOVE                            |  | DRAWN   |  | LUKE  |
|  | COLOR          |      | NATURAL(CLEAR)                       |  | CHECK   |  |  |
| PART NUMBER  | DRAWING NUMBER |      | UNLESS OTHERWISE SPECIFIED TOLERANCE |  | APPROVED  |  |   |
| LEM-189V0  | LEM-189        |      | SEE ABOVE                            |  |  |  |   |
| SIZE   | SCALE          | UNIT | REV                                  |  |   |  |   |
| A4   | 3:1            | mm   | A                                    |  |   |  |   |