

Introduction

The STM32 Nucleo-64-P boards, based on the MB1319 reference board (NUCLEO-L412RB-P, NUCLEO-L433RC-P, and NUCLEO-L452RE-P), provide an affordable and flexible way for users to try out new concepts and build prototypes with the STM32 microcontroller and the external SMPS (switched-mode power supply), which provides various combinations of performance, power consumption, and features.

ARDUINO® Uno V3 connectivity and ST morpho headers provide an easy means of expanding the functionality of the Nucleo open development platform with a wide choice of specialized shields.

The STM32 Nucleo-64-P boards do not require any separate probe, as they integrate the ST-LINK/V2-1 debugger/programmer. The STM32 Nucleo-64-P boards come with the comprehensive free STM32 software libraries and examples that are available with the STM32Cube package.

Figure 1. Nucleo-64-P board (top view)

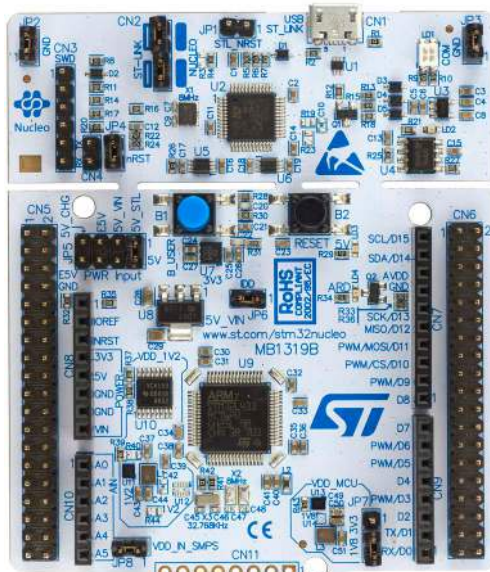
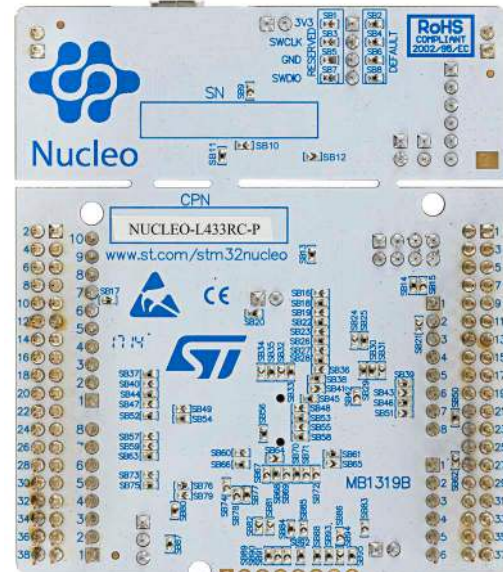

Figure 2. Nucleo-64-P board (bottom view)



Pictures are not contractual.



Contents

- 1 Features 7**
- 2 Ordering information 8**
 - 2.1 Codification 8
- 3 Development environment 9**
 - 3.1 System requirements 9
 - 3.2 Development toolchains 9
- 4 Conventions 10**
- 5 Quick start 11**
 - 5.1 Getting started 11
- 6 Hardware layout and configuration 12**
 - 6.1 STM32 Nucleo-64-P board layout 13
 - 6.2 STM32 Nucleo-64-P board mechanical drawing 15
 - 6.2.1 Default board configuration 15
 - 6.3 Cuttable PCB 16
 - 6.4 Embedded ST-LINK/V2-1 16
 - 6.4.1 Drivers 17
 - 6.4.2 ST-LINK/V2-1 firmware upgrade 17
 - 6.4.3 Using the ST-LINK/V2-1 to program/debug the STM32 18
 - 6.4.4 Using the ST-LINK/V2-1 to program/debug an external STM32 application. 18
 - 6.5 power supply and power selection 20
 - 6.5.1 External power supply input 20
 - 6.5.2 External power supply output 25
 - 6.5.3 SMPS power supply 25
 - 6.6 Programming/debugging when the power supply is not from ST-LINK (5V_ST_link) 26
 - 6.7 OSC clock sources 26
 - 6.7.1 LSE: OSC 32 KHz clock supply 26
 - 6.7.2 OSC clock supply 27

6.8	Reset sources	28
6.9	Virtual COM port: LPUART1/USART1	28
6.10	LEDs	28
6.11	Push-buttons	29
6.12	IDD measurement	29
6.13	Jumper configuration	30
6.14	Configuration of the solder bridges	30
7	Connectors	35
7.1	USB Micro-B connector CN1	35
7.2	ARDUINO® Uno V3 connectors	36
7.3	ST morpho connectors CN5 and CN6	39
7.4	External power connector	40
8	STM32 Nucleo-64-P board information	42
8.1	Product marking	42
8.2	NUCLEO-L412RB-P product history	42
8.2.1	Product identification NUL412RBP\$AU1	42
8.2.2	Product identification NUL412RBP\$AU2	42
8.3	NUCLEO-L412RB-P product limitations	43
8.3.1	Product identification NUL412RBP\$AU1 limitations	43
8.3.2	Product identification NUL412RBP\$AU2 limitations	43
8.4	NUCLEO-L433RC-P product history	43
8.4.1	Product identification NUCLEOL433RCP/	43
8.4.2	Product identification NUL433RCP\$AU1	43
8.5	NUCLEO-L433RC-P product limitations	43
8.5.1	Product identification NUCLEOL433RCP/ limitations	43
8.5.2	Product identification NUL433RCP\$AU1 limitations	43
8.6	NUCLEO-L452RE-P product history	43
8.6.1	Product identification NUCLEOL452REP/	43
8.6.2	Product identification NUL452REP\$AU1	44
8.7	NUCLEO-L452RE-P product limitations	44
8.7.1	Product identification NUCLEOL452REP/ limitations	44
8.7.2	Product identification NUL452REP\$AU1 limitations	44
8.8	Board revision history	44

8.8.1	MB1319 revision B-02	44
8.8.2	MB1319 revision C-01	44
8.8.3	MB1319 revision C-02	44
8.9	Board known limitations	44
8.9.1	Board MB1319 revision B-02 limitations	44
8.9.2	Board MB1319 revision C-01 limitations	44
8.9.3	Board MB1319 revision C-02 limitations	44
9	NUCLEO-L412RB-P, NUCLEO-L433RC-P, and NUCLEO-L452RE-P I/O assignment	45
10	Federal Communications Commission (FCC) and ISED Canada Compliance	48
10.1	FCC Compliance Statement	48
10.1.1	Part 15.19	48
10.1.2	Part 15.21	48
10.1.3	Part 15.105	48
10.2	ISED Canada Compliance Statement	48
10.2.1	Compliance Statement	49
10.2.2	Déclaration de conformité	49
11	CE / RED	50
11.1	EN55032 / CISPR32	50
	Revision history	51

List of tables

Table 1.	Ordering information	8
Table 2.	Codification explanation	8
Table 3.	ON/OFF convention	10
Table 4.	Default jumper settings	16
Table 5.	ST-LINK jumper configuration	17
Table 6.	Debug connector SWD	19
Table 7.	power supply capabilities	20
Table 8.	SB9 configurations	24
Table 9.	LPUART1 connection	28
Table 10.	USART1 connection	28
Table 11.	Jumper settings	30
Table 12.	Solder bridge configurations and settings.	31
Table 13.	USB Micro-B pinout	35
Table 14.	ARDUINO® connector pinout	37
Table 15.	External power connector pinout	41
Table 16.	NUCLEO-L412RB-P, NUCLEO-L433RC-P, and NUCLEO-L452RE-P I/O assignment	45
Table 17.	Document revision history	51

List of figures

Figure 1.	Nucleo-64-P board (top view)	1
Figure 2.	Nucleo-64-P board (bottom view)	1
Figure 3.	Hardware block diagram	12
Figure 4.	STM32 Nucleo-64-P board top layout	13
Figure 5.	STM32 Nucleo-64-P board bottom layout	14
Figure 6.	STM32 Nucleo-64 -P board mechanical drawing	15
Figure 7.	USB composite device	17
Figure 8.	ST-LINK debugger: jumper configuration for on-board MCU	18
Figure 9.	ST-LINK debugger: jumper configuration for external MCU	19
Figure 10.	JP5[1-2]: 5V_STL power source	21
Figure 11.	JP5[3-4]: 5V_VIN power source	22
Figure 12.	JP5[5-6]: E5V power source	23
Figure 13.	JP6[7-8]: 5V_USB_CHG power source	24
Figure 14.	USB Micro-B connector CN1 (front view)	35
Figure 15.	ARDUINO® connectors	36
Figure 16.	ARDUINO® connector pinout	37
Figure 17.	ST morpho connector	39
Figure 18.	ST morpho connector pinout	40
Figure 19.	External power connector	41

1 Features

STM32L4 Series Arm^{®(a)} Cortex[®]-M4 core-based microcontroller in an LQFP64 package

SMPS: significantly reduces power consumption in Run mode

32.768 kHz LSE crystal oscillator

One user LED shared with ARDUINO[®]

Two push-buttons: USER and RESET

ARDUINO[®] Uno V3 expansion connector

ST morpho expansion connector

External SMPS experimentation dedicated connector

Flexible board power supply: ST-LINK/V2-1 USB V_{BUS} or external sources

On-board ST-LINK/V2-1 debugger/programmer with USB reenumeration capability: mass storage, Virtual COM port, and debug port

Comprehensive free software libraries and examples available with the STM32Cube package

Support of a wide choice of Integrated Development Environments (IDEs) including IAR Embedded Workbench[®], MDK-ARM, and STM32CubeIDE



a. Arm is a registered trademark of Arm Limited (or its subsidiaries) in the US and/or elsewhere.

2 Ordering information

To order an STM32 Nucleo-64-P board, refer to, refer to [Table 1](#). Additional information is available from the datasheet and reference manual of the target STM32.

Table 1. Ordering information

Order code	Board reference	Target STM32
NUCLEO-L412RB-P	MB1319	STM32L412RBT6P
NUCLEO-L433RC-P		STM32L433RCT6P
NUCLEO-L452RE-P		STM32L452RET6P

2.1 Codification

The meaning of the codification is explained in [Table 2](#).

Table 2. Codification explanation

NUCLEO-XXYYRT-P	Description	Example: NUCLEO-L452RE-P
XX	MCU series in STM32 32-bit Arm Cortex MCUs	STM32L4 Series
YY	MCU product line in the series	STM32L452
R	STM32 package pin count	64 pins
T	STM32 flash memory size: – B for 128 Kbytes – C for 256 Kbytes – E for 512 Kbytes	512 Kbytes
-P	STM32 has an external SMPS function	External SMPS

3 Development environment

3.1 System requirements

Multi-OS support: Windows[®] 10, Linux[®] 64-bit, or macOS^{®(a)(b)(c)}
USB Type-A or USB Type-C[®] to Micro-B cable

3.2 Development toolchains

IAR Systems[®] - IAR Embedded Workbench^{®(d)}
Keil[®] - MDK-ARM^(d)
STMicroelectronics - STM32CubeIDE

-
- a. macOS[®] is a trademark of Apple Inc., registered in the U.S. and other countries and regions.
 - b. Linux[®] is a registered trademark of Linus Torvalds.
 - c. Windows is a trademark of the Microsoft group of companies.
 - d. On Windows[®] only.

4 Conventions

[Table 3](#) provides the conventions used for the ON and OFF settings in the present document.

Table 3. ON/OFF convention

Convention	Definition
Jumper JPx ON	Jumper fitted
Jumper JPx OFF	Jumper not fitted
Jumper JPx [1-2]	Jumper fitted between pin 1 and pin 2
Solder bridge SBx ON	SBx connections closed by 0 Ω resistor
Solder bridge SBx OFF	SBx connections left open
Resistor Rx ON	Resistor soldered
Resistor Rx OFF	Resistor not soldered
Capacitor Cx ON	Capacitor soldered
Capacitor Cx OFF	Capacitor not soldered

In this document, the references for all information that is common to all sale types, are 'STM32 Nucleo-64-P board' and 'STM32 Nucleo-64-P boards'.

5 Quick start

This section describes how to start development quickly using the STM32 Nucleo-64-P board.

Before installing and using the product, accept the Evaluation Product License Agreement from the www.st.com/epla webpage.

5.1 Getting started

The STM32 Nucleo-64-P board is a low-cost and easy-to-use development kit to evaluate and start quickly a development with an STM32 microcontroller in an LQFP64 package. To start using this board, follow the steps below:

1. Check the jumper position on the board, as shown in [Table 4: Default jumper settings](#).
2. For correct identification of all device interfaces from the host PC, install the Nucleo USB driver available on the www.st.com/stm32nucleo webpage, before connecting the board.
3. To power the board, connect the Nucleo-64-P board before a PC with a USB Type-A or USB Type-C[®] to Micro-B cable through USB connector CN1. As a result, the green LED LD3 (5 V PWR) lights up, LD1 (COM) and green LED LD4 blink.
4. Press user button B1 (blue).
5. Observe that the blinking frequency of the three green LEDs LD4 changes by clicking on the button B1.
6. The software demonstration and the several software examples that allow the user to use the Nucleo features, are available at the www.st.com/stm32nucleo webpage.
7. Develop an application using the available examples.

6 Hardware layout and configuration

The STM32 Nucleo-64-P board is designed around the STM32 microcontrollers in a 64-pins LQFP package.

Figure 3 illustrates the connection between the STM32 and the peripherals (ST-LINK/V2-1, push-buttons, LEDs, ARDUINO® Uno V3 connector, and ST morpho connectors).

Figure 4 and *Figure 5* show the location of these features on the STM32 Nucleo-64-P board.

The mechanical dimensions of the board are shown in *Figure 6*.

Figure 3. Hardware block diagram

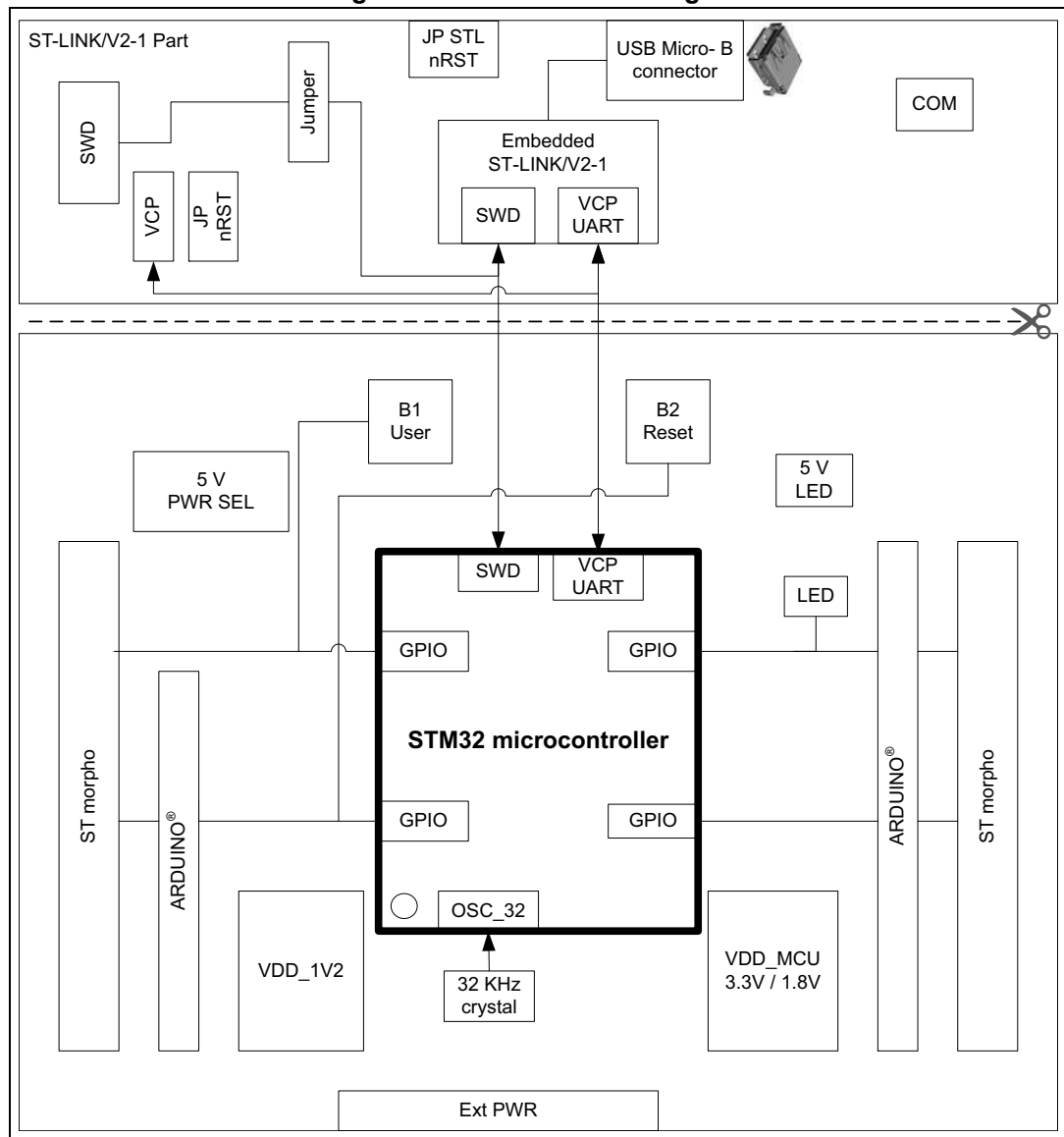

6.1 STM32 Nucleo-64-P board layout

Figure 4. STM32 Nucleo-64-P board top layout

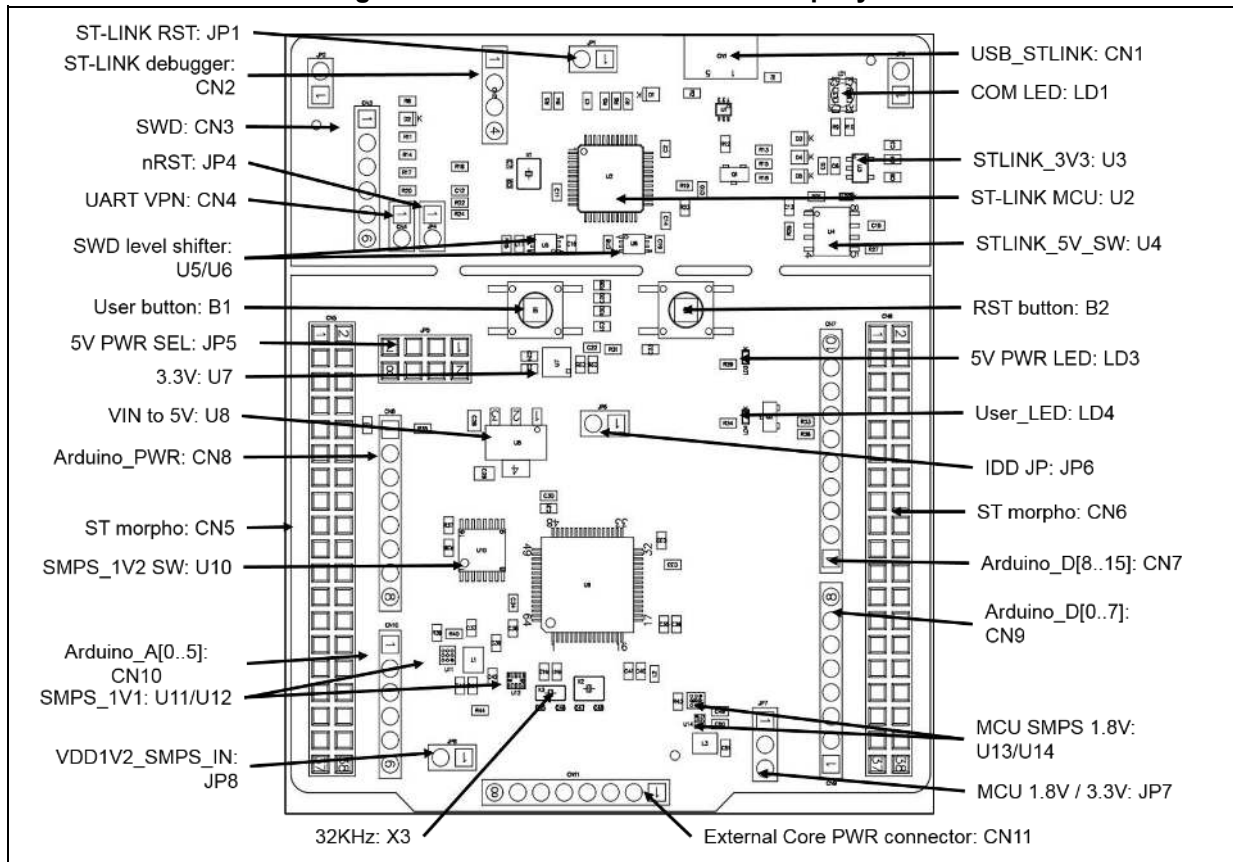
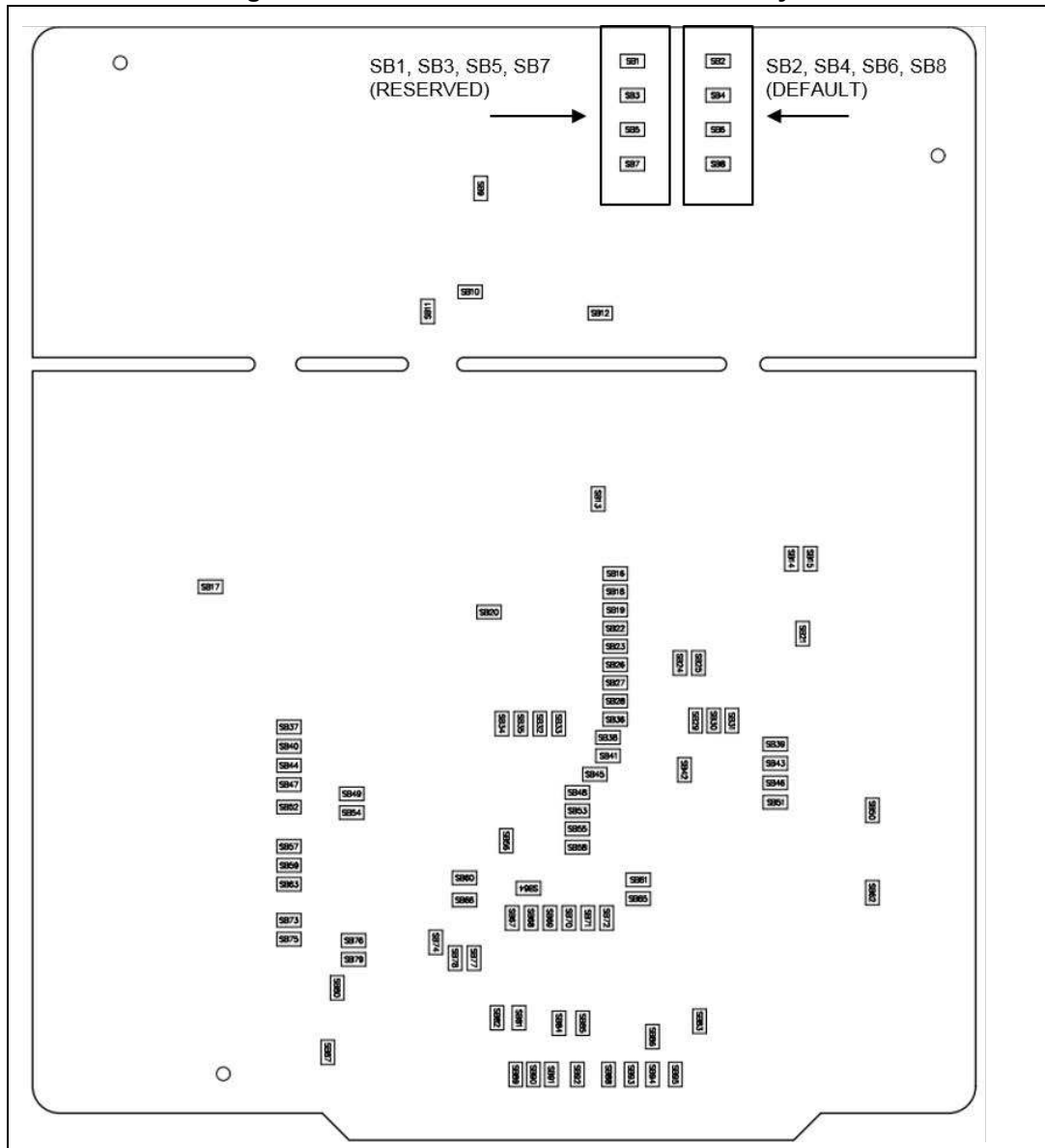
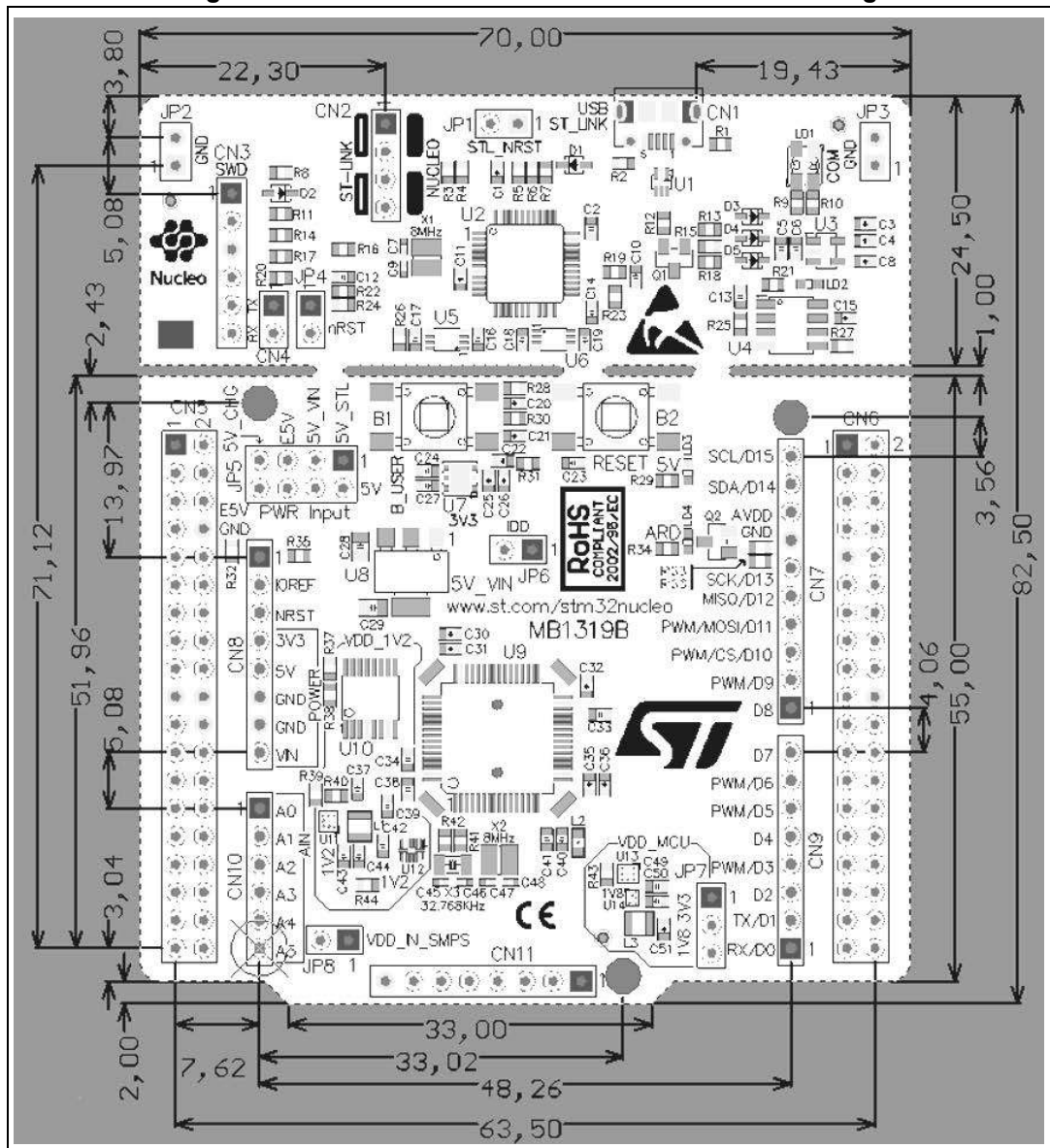

Figure 5. STM32 Nucleo-64-P board bottom layout



6.2 STM32 Nucleo-64-P board mechanical drawing

Figure 6. STM32 Nucleo-64 -P board mechanical drawing



6.2.1 Default board configuration

By default the STM32 Nucleo-64-P board is delivered with the external SMPS 1.1 V enabled and $V_{DD}@3.3$ V. It is possible to set the board for $V_{DD}@1.8$ V. Before switching to 1.8 V, the user must check that the extension module and the external shields connected to the Nucleo-64-P board are 1.8 V compatible.

The default jumper configuration and $V_{DD}@1.8$ V setting are shown in [Table 4](#).

Table 4. Default jumper settings

Jumper	Definition	Default position	Comment
CN2	SWD interface	ON [1-2] ON[3-4]	On-board ST-LINK/V2-1 debugger
JP1	STLK_RST	OFF	-
JP4	T_NRST	ON	-
JP5	5 V power selection	ON [1-2]	5 V from ST-LINK
JP6	I _{DD} measurement	ON	STM32 V _{DD} current measurement
JP7	V _{DD_MCU}	ON [1-2] (default)	V _{DD_MCU} voltage selection 3.3 V
		ON [2-3] (optional)	V _{DD_MCU} voltage selection 1.8 V
JP8	V _{DD_IN_SMPS}	ON	V _{DD_1V2} SMPS input power supply

6.3 Cuttable PCB

An STM32 Nucleo-64-P board is divided into two parts: ST-LINK and target STM32. The ST-LINK part of the PCB can be cut out to reduce the board size. In this case, the remaining target STM32 part can only be powered by V_{IN}, E5V, and 3.3 V on the CN5 ST morpho connector, or by V_{IN} and 3.3 V on the CN8 ARDUINO[®] connector.

It is still possible to use the ST-LINK part to program the STM32, using wires between the CN3 and SWD available signals on the ST morpho connector (SWCLK CN5 pin 17, SWDIO CN5 pin 15, and NRST CN5 pin 14, at the same I/O level as V_{DD_MCU}).

6.4 Embedded ST-LINK/V2-1

The ST-LINK/V2-1 programming and debugging tool is integrated on the STM32 Nucleo-64-P board.

For information about debugging and programming features, refer to the *ST-LINK/V2 in-circuit debugger/programmer for STM8 and STM32* user manual (UM1075) at the www.st.com website.

The changes versus the ST-LINK/V2 version are listed below.

New features supported on ST-LINK/V2-1 are:

- USB software reenumeration
- Virtual COM port interface on USB
- Mass storage interface on USB
- USB power management request for more than 100mA current on USB

The following features are no more supported on ST-LINK/V2-1:

- SWIM interface
- Application voltage lower than 3 V (need to add level shifter to support it)

The embedded ST-LINK/V2-1 can be used in two different ways according to the jumper configuration (refer to [Table 5](#)):

Program/debug the STM32 on board,

Program/debug an STM32 in an external application board using a cable connected to the SWD connector.

Table 5. ST-LINK jumper configuration

CN	Definition	Default position	Comment
CN3	T_SWCLK / T_SWDIO	ON [1-2] ON [3-4]	ST-LINK/V2-1 functions enabled for on-board programming (default)
	T_SWCLK / T_SWDIO	OFF [1-2] OFF [3-4]	ST-LINK/V2-1 functions enabled from external connector (SWD supported)

6.4.1 Drivers

Before connecting the STM32 Nucleo-64-P board to a Windows® PC (XP, 7, 8, and 10) through USB, install the driver for the ST-LINK/V2-1 that is available at the www.st.com website.

In case the STM32 Nucleo-64-P board is connected to the PC before installing the driver, the PC device manager may report some Nucleo interfaces as “Unknown”. To recover from this situation, after installing the dedicated driver, the association of “Unknown” USB devices found on the STM32 Nucleo-64-P board to this dedicated driver, must be updated in the device manager manually.

Note: It is recommended to proceed by using the USB composite device, as shown in [Figure 7](#).

Figure 7. USB composite device

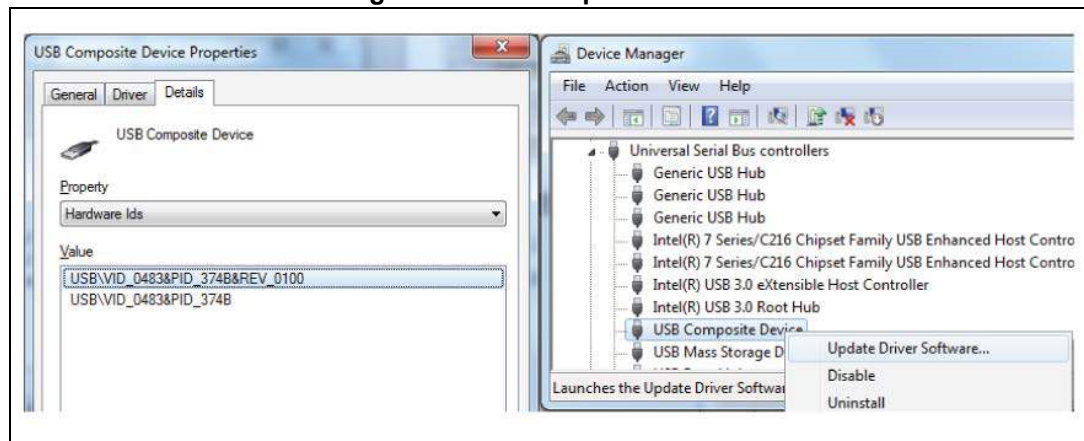

6.4.2 ST-LINK/V2-1 firmware upgrade

The ST-LINK/V2-1 embeds a firmware upgrade mechanism for the in-situ upgrade through the USB port. As the firmware may evolve during the lifetime of the ST-LINK/V2-1 product (for example new functionalities, bug fixes, support for new microcontroller families), it is recommended to keep the ST-LINK/V2-1 firmware up to date before starting to use an STM32 Nucleo-64-P board. The latest version of this firmware is available at the www.st.com website.

6.4.3 Using the ST-LINK/V2-1 to program/debug the STM32

To program the STM32, place the two jumpers marked in red on the CN2 connector, as shown in [Figure 8](#). Do not use the SWD connector to avoid disturbing the communication with the STM32 microcontroller of the Nucleo-64-P board.

Figure 8. ST-LINK debugger: jumper configuration for on-board MCU

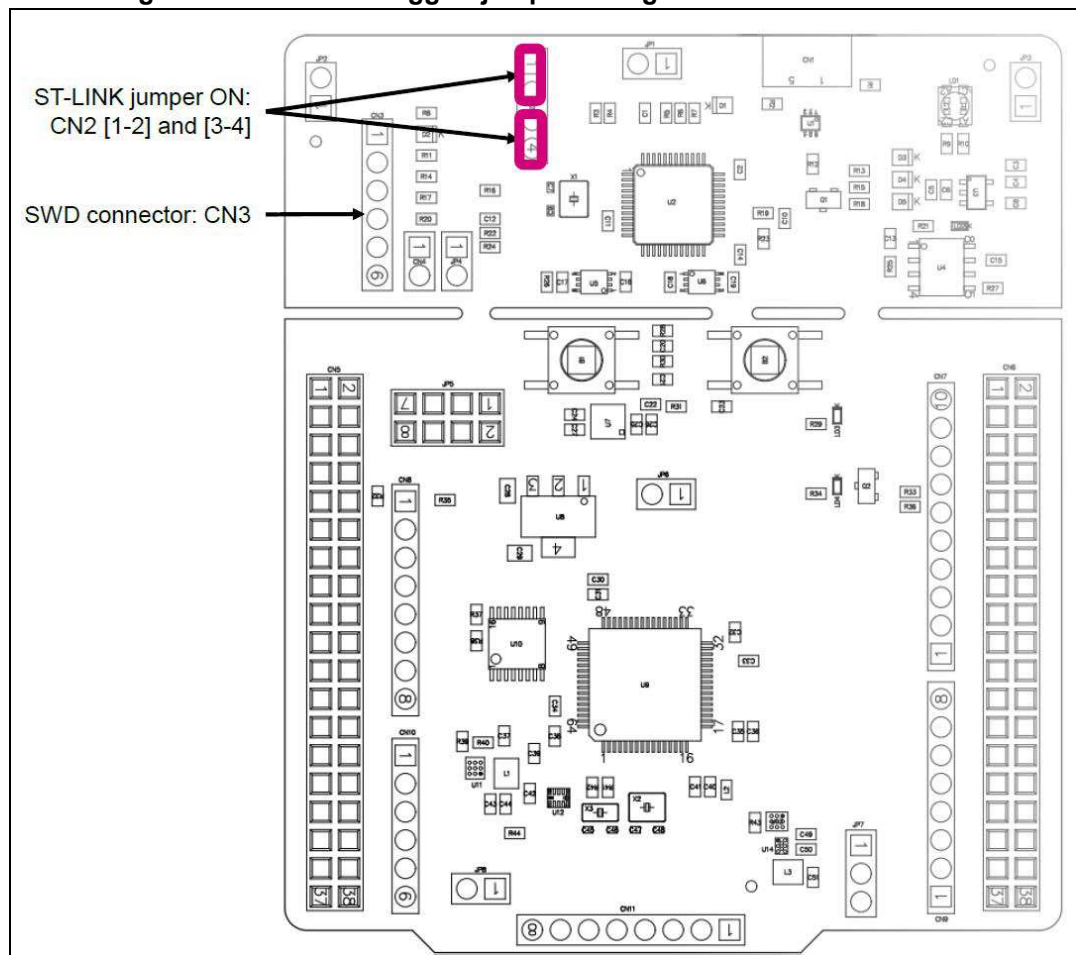

6.4.4 Using the ST-LINK/V2-1 to program/debug an external STM32 application.

It is very easy to use the ST-LINK/V2-1 to program the STM32 on an external application.

Simply remove the two jumpers from CN2, as shown in [Figure 9](#), and connect the application to the SWD debug connector according to [Table 6](#).

Note: JP4 NRST (target STM32 RESET) must be OFF when CN3 pin 5 is used in an external application.

Figure 9. ST-LINK debugger: jumper configuration for external MCU

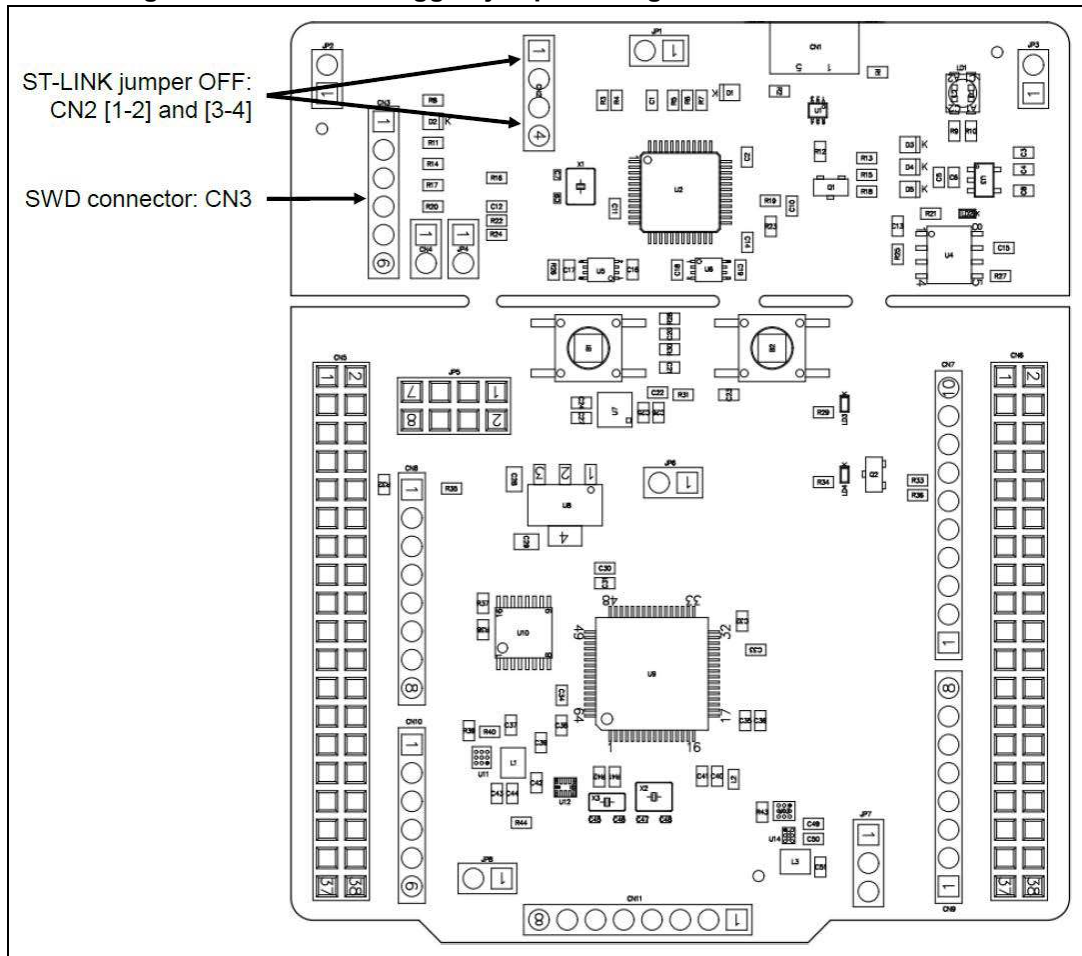

Table 6. Debug connector SWD

Connector	Pin number	Pin name	Signal name	STM32 pin	Function
SWD CN3	1	1	VDD_TARGET: AIN_1	PA0	V _{DD} from application
	2	2	T_JTCK	PA5	SWD clock
	3	3	GND	PA12	Ground
	4	4	T_JTMS	PA14	SWD data input/output
	5	5	T_NRST	PB0	RESET of target STM32
	6	6	T_SWO	PA10	SWD out (optional)

6.5 power supply and power selection

6.5.1 External power supply input

Several DC power supplies can power the STM32 Nucleo-64-P board. It is possible to supply the STM32 Nucleo-64-P board with any of the following sources:

- 5V_ST_LINK from the ST-LINK USB connector
- V_{IN} (7 V-12 V) from ARDUINO® connector or ST morpho connector
- E5V from ST morpho connector
- 5V_USB_CHARGER from ST-LINK USB
- 3.3 V on ARDUINO® connector or ST morpho connector

Note: If an external 5V DC power source is used, a power supply unit or a piece of auxiliary equipment complying with the EN-60950-1: 2006+A11/2009 standard, which must be safety extra-low voltage (SELV) with limited power capability, must power the Discovery kit.

The power supply capabilities are shown in [Table 7](#).

Table 7. power supply capabilities

Input power name	Connector pins	Voltage range	Max current	Limitation
V_{BUS} (5V_STLINK)	CN1 pin 1	4.75 to 5.25 V	500 mA	The maximum current depends on the USB enumeration: – 100 mA without enumeration – 500 mA with enumeration OK
V_{IN}	CN8 pin 8 CN5 pin 24	7 to 12 V	800 mA	From 7 to 12 V only and input current capability is linked to input voltage: – 800 mA input current when $V_{IN}=7$ V – 450 mA input current when $7 V < V_{IN} < 9$ V – 300 mA input current when $10 V > V_{IN} > 9$ V – less than 300 mA input current when $V_{IN} > 10$ V
E5V	CN5 pin 6	4.75 to 5.25 V	500 mA	
5V_USB_CHG	CN1 pin 1	4.75 to 5.25 V	500 mA	The maximum current depends on the USB wall charger used to power the Nucleo board
3.3V	CN8 pin 4 CN5 pin 16 JP6 pin 2	3.0 to 3.6 V	-	Used when ST-LINK part of PCB not used or removed and SB13 OFF

5V_ST_LINK is a DC power with limitations from the ST-LINK USB connector (USB type Micro-B connector of ST-LINK/V2-1). In this case, the JP5 jumper must be on pins 1 and 2 to select the 5V_STL power source on the JP5 silkscreen. This is the default setting. If the USB enumeration succeeds, the 5V_ST_LINK power is enabled, by asserting the PWR_ENn signal (from STM32F103CBT6). This pin is connected to a power switch ST890,

which powers the board. This power switch also features a current limitation to protect the PC in case of a short circuit on board (more than 750 mA).

The STM32 Nucleo-64-P board and its shield can be powered from the ST-LINK USB connector CN1, but only the ST-LINK circuit is powered before USB enumeration because the host PC only provides 100 mA to the board at that time. During the USB enumeration, the STM32 Nucleo-64-P board requires 500 mA of current to the host PC. If the host can provide the required power, the enumeration ends by a *SetConfiguration* command and then, the power transistor ST890 is switched ON, the green LED LD3 is turned ON, thus the STM32 Nucleo-64-P board and its shield request no more than 500 mA current. If the host is not able to provide the required current, the enumeration fails. Therefore, the power switch ST890 stays OFF and the MCU part including the extension board is not powered. As a consequence, the green LED LD3 stays turned OFF. In this case, it is mandatory to use an external power supply.

USB power

5V_STL configuration: the JP5 jumper must be connected as shown in [Figure 10](#).

Figure 10. JP5[1-2]: 5V_STL power source

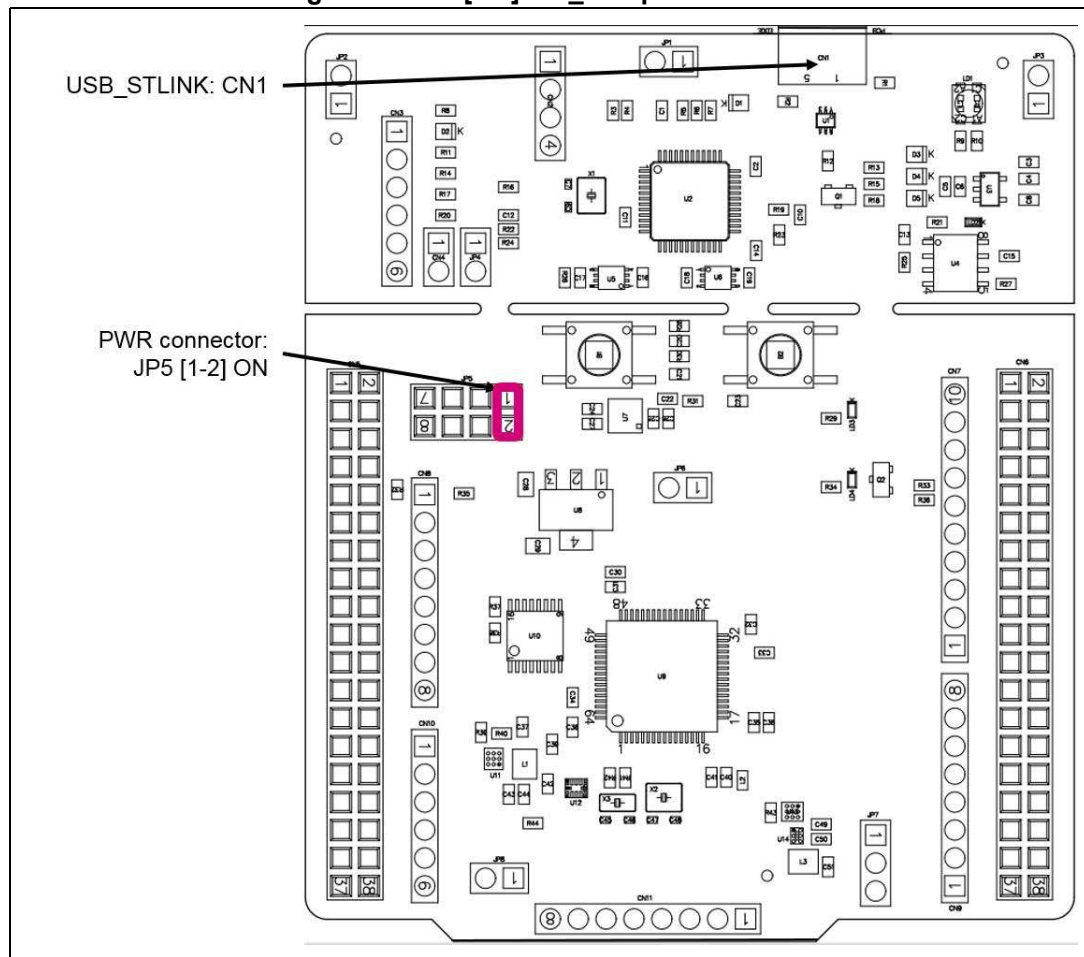

VIN (5V_VIN) is the 7-12 V DC-power from the ARDUINO® CN8 pin 8 named V_{IN} on the ARDUINO® connector silkscreen, or from the pin 24 of the CN5 ST morpho connector. In this

case, the JP5 jumper must be on pins 3 and 4 to select the 5V_VIN power source on the JP5 silkscreen. In that case, the DC power comes from the power supply through the ARDUINO® Uno V3 battery shield, compatible with the Adafruit® PowerBoost 500 shield.

5V_VIN configuration: The JP5 jumper must be connected as shown in [Figure 11](#).

Figure 11. JP5[3-4]: 5V_VIN power source

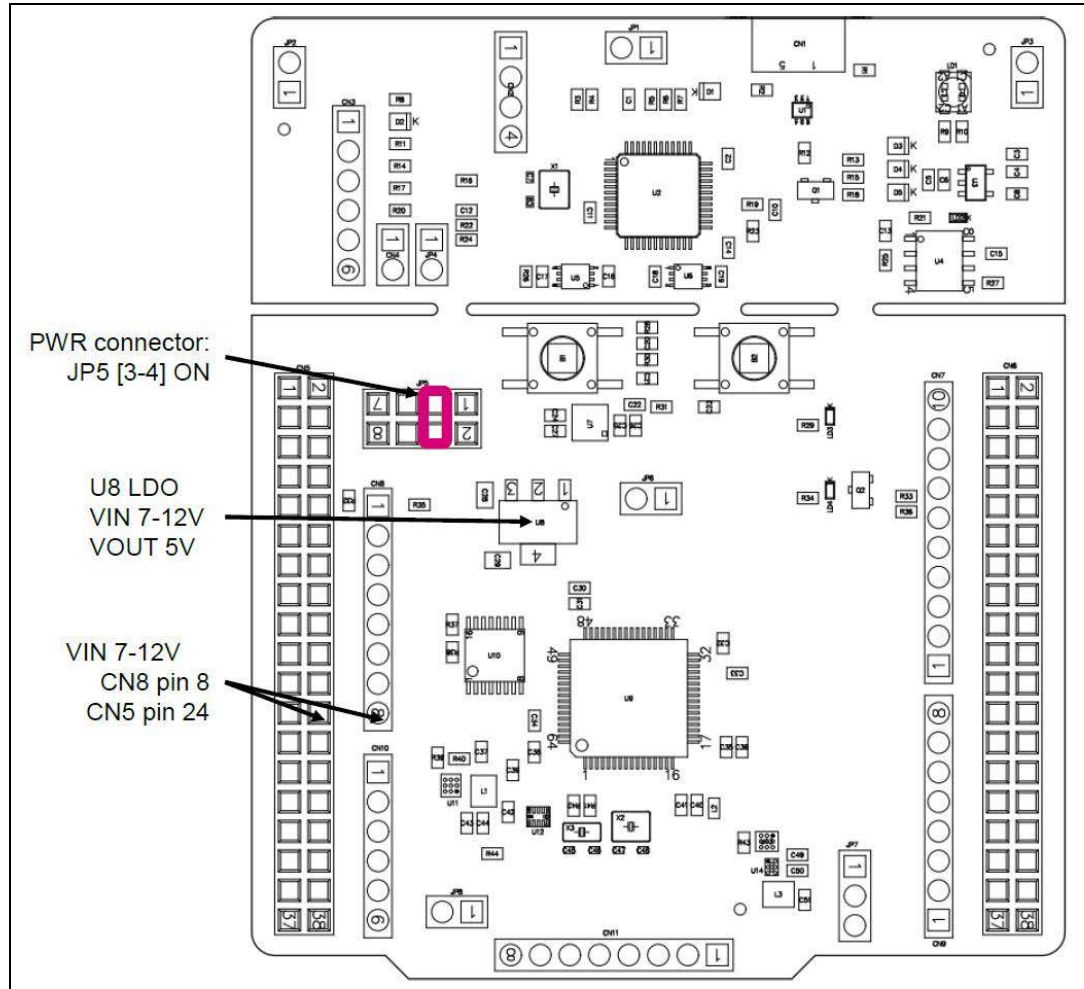

E5V is the external DC power (5V DC power from ST morpho connector CN5 pin 6). In this case, the JP5 jumper must be on pins 5 and 6 to select the E5V power source on the JP5 silkscreen.

E5V configuration: Jumper JP5[5-6] must be connected as shown in [Figure 12](#).

Figure 12. JP5[5-6]: E5V power source

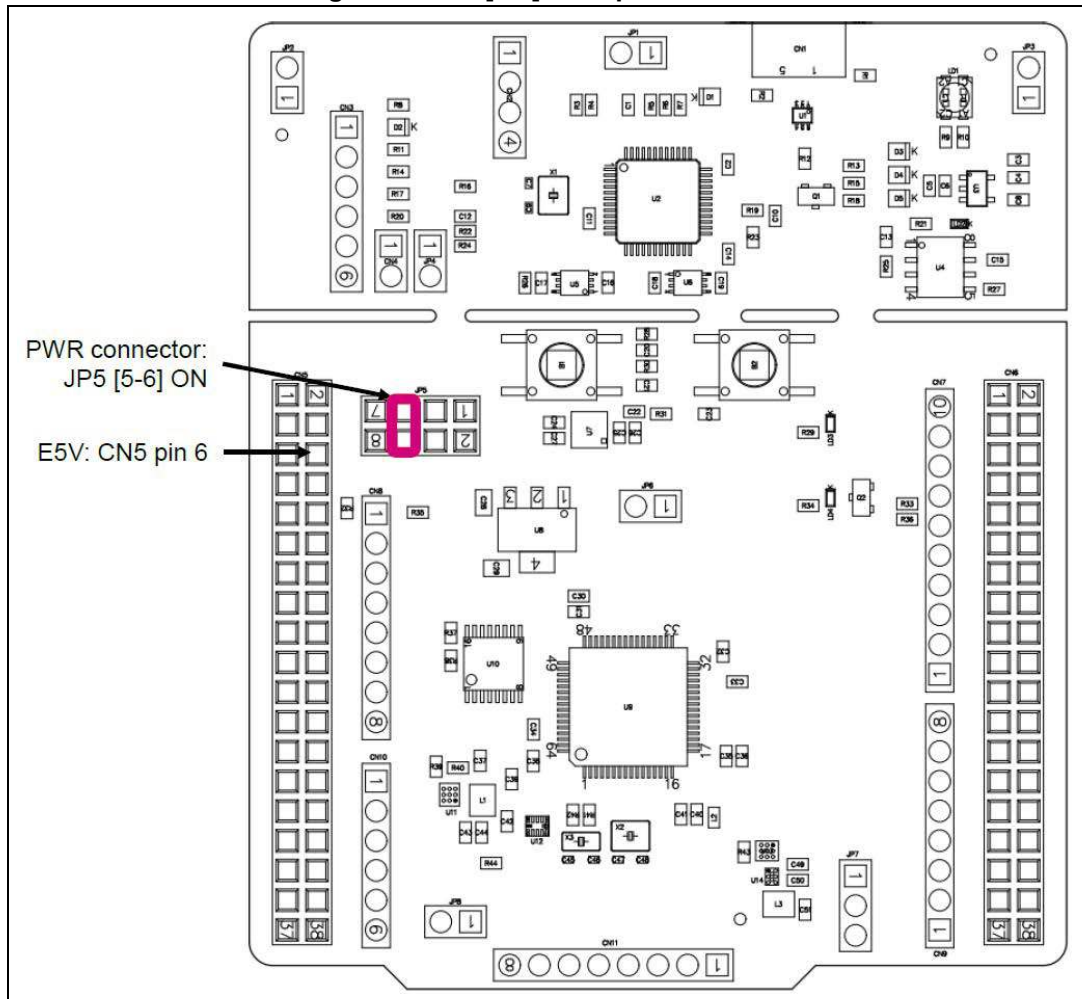

5V_USB_CHARGER is the DC power charger connected to USB ST-LINK (CN1). To select the 5V_USB_CHARGER power source on the JP5 silkscreen, the JP5 jumper must be on pins 7 and 8. In this case, if the STM32 Nucleo-64-P board is powered by an external USB board the debug is not available. If the PC is connected instead of the charger, the limitation is no more effective. In this case, the PC could be damaged.

5V_USB_CHG configuration: the JP5 jumper must be connected as shown in [Figure 13](#).

Figure 13. JP6[7-8]: 5V_USB_CHG power source

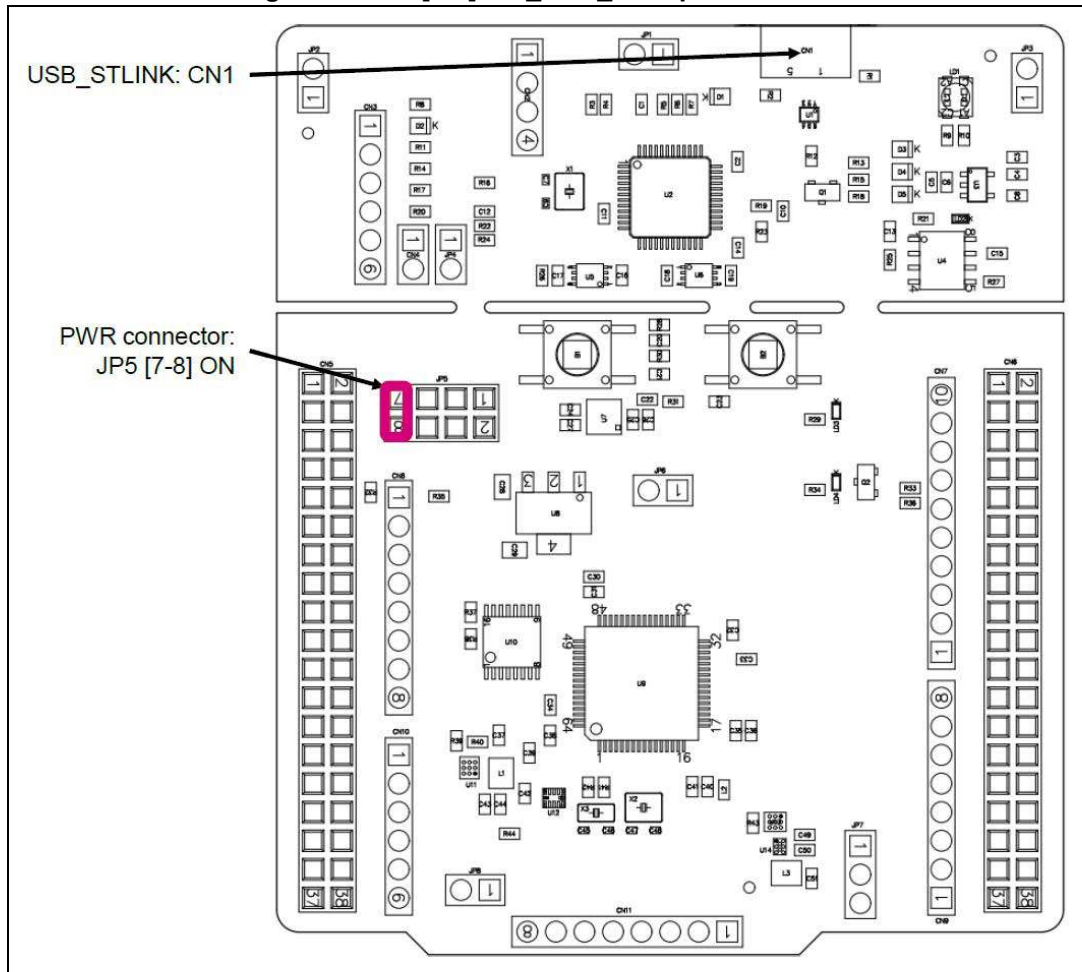

Caution: The solder bridge SB9 can be used to bypass the USB power protection ST890. **This is not an ST-recommended setting.** SB9 can be set in case the board is powered by the USB of the PC and the maximum current consumption on 5V_STLINK **does not exceed 100 mA** (including extension board or ARDUINO® shield power consumption). In such conditions, USB enumeration always succeeds since no more than 100 mA is requested for the PC. Configurations of SB9 are summarized in [Table 8](#).

Table 8. SB9 configurations

Solder bridge	Default position	Power supply	Allowed current
SB9	OFF	USB PWR through CN1	500 mA maximum current limited by ST890
	ON		100 mA maximum current
	OFF	VIN or E5V PWR	No current limitation
	ON		SB9 must be removed when the board is powered ⁽¹⁾

1. SB9 must be removed when the board is powered by E5V (CN5 pin 6) or by VIN (CN8 pin 8 or CN5 pin 24).

Warning: In case the maximum current consumption of the STM32 Nucleo-64-P board with its extension boards exceeds 500 mA, it is recommended to power the STM32 Nucleo-64-P board using an external power supply connected to E5V or V_{IN} .

6.5.2 External power supply output

5 V: 5 V (CN8 pin 5 or CN5 pin 18) can be used as the output power supply for an ARDUINO® shield or an extension board, when the STM32 Nucleo-64-P board is powered by USB, V_{IN} or E5V. In this case, the maximum current allowed is shown in [Table 7](#).

3.3 V: 3.3 V (CN8 pin 4 or CN5 pin 16) can be also used as power supply output. The current is limited by the maximum current capability of the regulator U7 (LD39050PUR33 from STMicroelectronics). In this condition, the maximum consumption of the STM32 Nucleo-64-P board and the connected shield must be less than 500 mA.

6.5.3 SMPS power supply

The following actions significantly improve the power figures in Run mode:

- Generate the V_{core} logic supply from an external SMPS (switched-mode power supply) or from an external connector

- Generate the V_{DD_MCU} supply from an external SMPS (switched-mode power supply), or from an external connector

The STM32 Nucleo-64-P board is populated with two SMPSs, U11 and U13, with the following functions:

- SMPS U11 can supply dynamically the V_{DD_1V2} pins in Run mode at 1.1 V with a maximum current of 30 mA.

- SMPS U13 can supply the V_{DD_MCU} pin at 1.8 V with a maximum current of 50 mA (hysteresis operation mode). The SMPS U13 can deliver higher current (PWM operation mode) but with less efficiency. To set the U13 SMPS in PWM mode, remove SB80 and solder SB79. This SMPS is enabled by default.

V_{DD_MCU} configuration:

- 3.3 V: JP7 [1-2] (default)

- 1.8 V: JP7 [2-3] (best ULPBench score)

Note: *The ST-LINK is still available in this configuration, thanks to the level shifters U5 and U6.*

For all general information concerning design recommendations for the STM32 with external SMPS, refer to the *Design recommendations for STM32L4xxxx with external SMPS, design guide for ultra-low-power applications with performance* application note (AN4978) available at the www.st.com website.

6.6 Programming/debugging when the power supply is not from ST-LINK (5V_ST_link)

V_{IN} or E5V is used as an external power supply in case the current consumption of the STM32 Nucleo-64-P board and its extension boards exceed the allowed current on the USB. In such conditions, it is still possible to use the USB for communication, programming, or debugging only.

In this case, it is mandatory to power the board first using V_{IN} or E5V then connect the USB cable to the PC. Proceeding this way the enumeration succeeds, thanks to the external power source.

The following power sequence procedure must be respected:

1. Connect jumper JP5 between pins 3 and 4 for V_{IN} or pins 5 and 6 for E5V.
2. Be sure that SB9 is removed.
3. Connect the external power source to V_{IN} or E5V.
4. Power ON the external power supply $7\text{ V} < V_{IN} < 12\text{ V}$ to V_{IN} , or 5 V for E5V.
5. Check that the green LED LD3 is turned ON.
6. Connect the PC to the USB connector CN1.

If this sequence is not respected, the board may be powered by V_{BUS} first from the ST-LINK, with the following risks:

If the board needs more than 500 mA current, the PC may be damaged or the current supply limited by the PC. As a consequence, the board is not powered correctly.

500 mA is requested at the enumeration (since SB9 must be OFF): this request can be rejected and the enumeration does not succeed if the PC cannot provide such current. Consequently, the board is not power supplied (LED LD3 remains OFF).

6.7 OSC clock sources

Three clock sources are listed below:

LSE, which is the 32.768 kHz crystal for the STM32 embedded RTC

MCO, which is the 8 MHz clock from the ST-LINK MCU for the STM32 microcontroller

HSE, which is the 8 MHz oscillator for the STM32 microcontroller. This clock is not implemented on the STM32 Nucleo-64-P board.

6.7.1 LSE: OSC 32 KHz clock supply

There are three ways to configure the pins corresponding to the low-speed clock (LSE):

LSE on-board oscillator X3 crystal (default configuration). Refer to the *Oscillator design guide for STM8S, STM8A and STM32 microcontrollers* application note (AN2867). It is recommended to use the NX3215SA manufactured by NDK (32.768 kHz, 6 pF, 20 ppm).

Oscillator from external to PC14 input: From the external oscillator through pin 25 of the CN5 connector.

The following configuration is needed:

SB71 and SB72 ON

R41 and R42 removed

LSE not used: PC14 and PC15 are used as GPIOs instead of low-speed clock providers.

The following configuration is needed:

SB71 and SB72 ON
R41 and R42 removed

6.7.2 OSC clock supply

There are four ways to configure the pins corresponding to the external-high-speed clock (HSE):

MCO from ST-LINK (default: not connected): MCO output of ST-LINK MCU is used as an input clock. This frequency cannot be changed. It is fixed at 8 MHz and connected to PH0 OSC_IN of the STM32 microcontroller.

The following configuration is needed:

SB67, SB69, and SB70 OFF
SB64 ON
R19 and C10 ON respectively with 100 Ω and 20 pF

In this configuration, PH1 is used as I/O (SB68 ON).

HSE: on-board oscillator X2 crystal (default: not connected): for typical frequencies and its capacitors and resistors, refer to the STM32 microcontroller datasheet. Refer to the *Oscillator design guide for STM8S, STM8A and STM32 microcontrollers* application note (AN2867) as the oscillator design guide for the STM32 microcontrollers. The X2 crystal has the following characteristics: 8 MHz, 8 pF, 20 ppm. It is recommended to use NX3225GD manufactured by NDK.

The following configuration is needed:

SB64, SB68, SB70 OFF
SB67 and SB69 ON
C47 and C48 ON with 8.2 pF capacitors

External oscillator to PH0 input (default: not connected): from an external oscillator through pin 29 of the CN5 connector.

The following configuration is needed:

SB64, SB67, and SB69 OFF
SB70 ON

In this configuration, PH1 is used as I/O (SB68 ON)

HSE not used (default configuration): PH0 and PH1 are used as GPIOs and not as clocks.

The following configuration is needed:

SB58 and SB60 OFF
SB59 and SB61 ON
R21 removed

6.8 Reset sources

The reset signal of the STM32 Nucleo-64-P board is active low and the reset sources include:

- Reset button B2
- Embedded ST-LINK/V2-1
- ARDUINO® Uno V3 connector from CN8 pin 3
- ST morpho connector CN5 pin 14

6.9 Virtual COM port: LPUART1/USART1

The LPUART1 or USART1 interface of the STM32 can be connected to:

- The ST-LINK/V2-1 MCU
- The ARDUINO® Uno V3 connectors: CN9 (pins 1 and 2)
- The ST morpho connector (pins 35 and 37).

The LPUART1 or USART1 interface is selected by setting the related solder bridge (see [Table 9](#) and [Table 10](#)).

Table 9. LPUART1 connection

Solder bridge	Feature
SB66 / SB75 ON SB32, SB34, SB60, SB73 OFF	LPUART1 (PA2/PA3) connected to ST-LINK Virtual COM port.
SB60 / SB73 ON SB33, SB35 SB66, SB75 OFF	LPUART1 (PA2/PA3) connected to ARDUINO® and ST morpho connector.

Table 10. USART1 connection

Solder bridge	Feature
SB32 / SB34 ON SB33, SB35, SB66, SB75 OFF	USART1 (PA9/PA10) connected to ST-LINK Virtual COM port.
SB33 / SB35 ON SB32, SB34 SB60, SB73 OFF	USART1 (PA9/PA10) connected to ARDUINO® and ST morpho connector.

By default:

- Communication between the STM32 target and the ST-LINK/V2-1 MCU is enabled on LPUART1 to support the Virtual COM port.
- Communication between the STM32 target and the ARDUINO® and ST morpho connector is enabled on USART1.

The Virtual COM port settings are 115200 bps, 8 bits data, no parity, 1 stop bit, and no flow control.

6.10 LEDs

Four LEDs are available on the STM32 Nucleo-64-P board. The four LEDs are located on the top side of the board.

LD1 COM: LD1 is a bicolor LED. The LD1 default status is red. LD1 turns to green to indicate that communication is in progress between the PC and the ST-LINK/V2-1 as follows:

Slow blinking red/OFF: At power-on before USB initialization

Fast blinking red/OFF: After the first correct communication between the PC and the ST-LINK/V2-1 (enumeration)

Red LED ON: When initialization between the PC and the ST-LINK/V2-1 is successfully ended

Green LED ON: After successful STM32 communication initialization

Blinking red/green: During communication with STM32

Green ON: Communication well ended

Orange ON: Communication ended with failure

LD2: 5V_USB: this red LED switch is ON when overcurrent is detected on USB V_{BUS} . The LED gives the information that more than 500 mA is requested on V_{BUS} . In this case, it is recommended to supply the board by E5V, V_{IN} or in USB charger mode.

LD3: 5V_PWR: this green LED is ON when the STM32 Nucleo-64-P board is powered by a 5 V source.

LD4 USER: this green LED is a user LED connected to ARDUINO[®] signal D13 corresponding to STM32 I/O PB13. To light the LED, a high-logic state "1" has to be written in the corresponding GPIO. A transistor is used to drive the LED when the I/O voltage is 1.8 V. LD4 consumption does not impact the V_{DD} STM32 power measurement, since LD4 is isolated from it.

6.11 Push-buttons

Two buttons are available on the STM32 Nucleo-64-P board.

B1 USER: The blue button for the user and wake-up function is connected by default to the PC13 I/O or optionally to the PA0 I/O of the STM32. When the button is depressed the logic state is "1", otherwise the logic state is "0".

B2 RESET: The black button is connected to NRST and is used to RESET the STM32. When the button is depressed the logic state is "0", otherwise the logic state is "1".

The blue and black plastic hats placed on these push-buttons can be removed if necessary when a shield or an application board is plugged on top of the STM32 Nucleo-64-P board. This is to avoid pressure on the buttons and consequently a possible permanent STM32 RESET.

6.12 IDD measurement

The JP6 jumper labeled **IDD** is used to measure the STM32 microcontroller, the level shifter, and the SMPS consumptions (depending on solder-bridge configuration), by removing the jumper and by connecting a multimeter:

Jumper ON: directly powered (default)

Jumper OFF: a multimeter or an external 3.3 V power source must be connected to measure the consumption

Note: The STM32 Nucleo-64-P board LEDs are connected before the jumper. The LEDs consumption does not impact the V_{DD_MCU} power measurement.

6.13 Jumper configuration

The default jumper positions are shown in [Table 4: Default jumper settings](#). [Table 11](#) describes the other available jumper settings.

Table 11. Jumper settings

Jumper / CN	Function	State ⁽¹⁾	Comment
CN2	T_SWCLK T_SWDIO	ON [1-2] ON [3-4]	ST-LINK/V2-1 enable for on-board MCU debugger
		OFF	ST-LINK/V2-1 functions enabled for external CN2 connector
JP1	STLK_RST	ON [1-2]	Used to reset ST-LINK MCU
		OFF	Normal use
JP2/JP3	GND	OFF	GND probe
JP4	T_NRST	ON	ST-LINK able to reset STM32
		OFF	ST-LINK not able to reset STM32
JP5	5 V power selection	ON [1-2]	5 V from ST-LINK
		ON [3-4]	5 V from V_{IN} 7-12 V
		ON [5-6]	5 V from E5V
		ON [7-8]	5 V from USB_CHG
		OFF	No 5 V power, use 3.3 V
JP6	I_{DD} measurement	ON [1-2]	$V_{DD} = 3.3 V$
		OFF	To connect the external source (ULPBench probe as an example)
JP7	$V_{DD_MCU} = 3.3 V$	ON [1-2]	V_{DD_MCU} voltage selection = 3.3 V
		ON [2-3]	V_{DD_MCU} voltage selection = 1.8 V
		OFF	No V_{DD_MCU} (forbidden)
JP8	$V_{DD_IN_SMPS}$	ON [1-2]	1.1 V external SMPS input power supply
		OFF	1.1 V external SMPS not powered. Legacy configuration

1. The default jumper state is shown in bold.

6.14 Configuration of the solder bridges

[Table 12](#) shows the solder bridge configurations and settings.

Table 12. Solder bridge configurations and settings

Definition	Bridge	State ⁽¹⁾	Comment
SWD interface (reserved)	SB1/SB3 /SB5/SB7	OFF	Reserved, do not modify.
SWD interface (default)	SB2/SB4 /SB6/SB8	ON	Reserved, do not modify.
USB power by-pass mode	SB9	ON	USB power switch by-passed (not recommended)
		OFF	USB power switch protection enabled
SWO level shifter by-pass	SB10	ON	SWO not connected through level shifter
		OFF	SWO connected through level shifter to target MCU for 1.8 V I/O configuration
SWO_MCU	SB11	ON	SWO_MCU connected between ST-LINK and target STM32
		OFF	SWO_MCU not connected between ST-LINK and target STM32
STLK_RX by-pass	SB12	ON	STLK_RX not connected through level shifter
		OFF	STLK_RX connected through level shifter to target STM32 for 1.8 V I/O configuration
3.3 V LDO output	SB13	ON	U7 LDO output provides 3.3 V
		OFF	U7 LDO output does NOT provide 3.3 V. The user has to connect an external 3.3 V source.
IOREF selection	SB14	ON	IOREF connected to V _{DD_MCU} power supply
		OFF	IOREF NOT connected to V _{DD_MCU} power supply
	SB15	ON	IOREF connected to the 3.3 V _{PER} power supply
		OFF	IOREF NOT connected to the 3.3 V _{PER} power supply
	SB21	ON	IOREF connected to a 3.3 V power supply
		OFF	IOREF NOT connected to a 3.3 V power supply
user LED	SB17	ON	User LED driven by PB13 (ARD_D13)
		OFF	User LED not driven
Peripheral 3.3 V	SB20	ON	Peripheral power supply connected to 3.3 V
		OFF	Peripheral power supply not powered
V _{DDUSB} power supply MCU pin48	SB24	ON	V _{DDUSB} pin 48 powered by V _{DD}
		OFF	V _{DDUSB} pin 48 is NOT powered by V _{DD}
	SB25	ON	V _{DDUSB} pin 48 powered by V _{DD_MCU}
		OFF	V _{DDUSB} pin 48 is NOT powered by V _{DD_MCU}
V _{DD_1V2} switch power supply	SB29	ON	U10 V _{DD_1V2} power switch powered by V _{DD-IN} SMPS 3.3 V
		OFF	U10 V _{DD_1V2} power switch NOT powered by V _{DD-IN} SMPS 3.3 V
	SB42	ON	U10 V _{DD_1V2} power switch powered by 1.8 V
		OFF	U10 V _{DD_1V2} power switch NOT powered by 1.8 V

Table 12. Solder bridge configurations and settings (continued)

Definition	Bridge	State ⁽¹⁾	Comment
U11/U12 SMPS out 1.1 V	SB30 / SB46	ON	U11/U12 powers V _{DD_1V2} through the U10 switch.
		OFF	U11/U12 directly powers V _{DD_1V2} . U10 switch is not used (not recommended, see AN4978 on the www.st.com website).
	SB43	ON	U11/U12 directly powers V _{DD_1V2} . U10 switch is not used (not recommended, see AN4978 on the www.st.com website).
		OFF	U11/U12 powers V _{DD_1V2} through the U10 switch.
VOUTCORE	SB31 / SB46	ON	The external V _{outvcore} from CN10 powers V _{DD_1V2} through the U10 switch.
		OFF	The external V _{outvcore} from CN10 directly powers V _{DD_1V2} . U10 switch is not used (not recommended, see AN4978 on the www.st.com website).
	SB39	ON	The external V _{outvcore} from CN10 directly powers V _{DD_1V2} . U10 switch is not used (not recommended, see AN4978 on the www.st.com website).
		OFF	The external V _{outvcore} from CN10 powers V _{DD_1V2} through the U10 switch.
VOUT2	SB51	ON	MCU V _{DD_1V2} connected to U12 V _{OUT2}
		OFF	MCU V _{DD_1V2} NOT connected to U12 V _{OUT2}
PA10 UART1_RX	SB32	ON	STLINK_RX connected to UART1_RX PA10
		OFF	STLINK_RX NOT connected to UART1_RX PA10
	SB33	ON	ARD_D0_RX connected to UART1_RX PA10
		OFF	ARD_D0_RX NOT connected to UART1_RX PA10
PA9 UART1_TX	SB34	ON	STLINK_TX connected to UART1_TX PA9
		OFF	STLINK_TX NOT connected to UART1_TX PA9
	SB35	ON	ARD_D1_TX connected to UART1_TX PA9
		OFF	ARD_D1_TX NOT connected to UART1_TX PA9
PA2 LPUART1_TX	SB60	ON	ARD_D1_TX connected to LPUART1_TX PA2
		OFF	ARD_D1_TX NOT connected to LPUART1_TX PA2
	SB66	ON	STLINK_TX connected to LPUART1_TX PA2
		OFF	STLINK_TX NOT connected to LPUART1_TX PA2
PA3 LPUART_RX	SB73	ON	ARD_D0_RX connected to LPUART1_RX PA3
		OFF	ARD_D0_RX NOT connected to LP UART1_RX PA3
	SB75	ON	STLINK_RX connected to LPUART1_RX PA3
		OFF	STLINK_RX NOT connected to LPUART1_RX PA3

Table 12. Solder bridge configurations and settings (continued)

Definition	Bridge	State ⁽¹⁾	Comment
User button	SB50	ON	User button connected to PC13
		OFF	User button NOT connected to PC13
	SB62	ON	User button connected to PA0
		OFF	User button NOT connected to PA0
AGND	SB56	ON	AGND connected to GND. Reserved, do not modify.
V _{BAT} MCU power supply pin1	SB61	ON	V _{BAT} pin 1 powered by V _{DD_MCU}
		OFF	V _{BAT} pin 1 NOT powered by V _{DD_MCU}
	SB65	ON	V _{BAT} pin 1 powered by V _{DD}
		OFF	V _{BAT} pin 1 NOT powered by V _{DD}
HSE CLK selection	SB64	ON	ST-LINK MCO used for HSE CLK
		OFF	ST-LINK MCO NOT used for HSE CLK
	SB67/SB69	ON	HSE provided by the external HSE CLK X2
		OFF	HSE NOT provided by the external HSE CLK X2
	SB68	ON	PH1 connected to ST morpho connector I/O usage
		OFF	PH1 NOT connected to ST morpho connector
	SB70	ON	PH0 connected to ST morpho connector
		OFF	PH0 NOT connected to ST morpho connector MCO usage
LSE CLK selection	SB71/SB72	ON	PC14 and PC15 connected to ST morpho connector, LSE NOT provided by the external LSE CLK X3
		OFF	LSE provided by the external HSE CLK X3 (R41/R42). PC13 and PC14 are not connected to ST morpho connector
SMPS 1.8 V part input	SB76	ON	SMPS 1.8 V U13/U14 powered by V _{DD} =3.3 V
		OFF	SMPS 1.8 V U13/U14 NOT powered
AVDD / VREF	SB77	ON	V _{DDA} pin 13 powered by V _{DD}
		OFF	V _{DDA} pin 13 NOT powered by V _{DD}
	SB78	ON	V _{DDA} pin 13 powered by V _{DD_MCU}
		OFF	V _{DDA} pin 13 NOT powered by V _{DD_MCU}
U13 mode SYN/PWM	SB79	ON	U13 is in PWM mode
	SB80	SB80 ON	U13 is in hysteresis mode
ST1PS02 voltage selection	SB81/SB82 SB90/SB91/SB94 SB96/SB97		Refer to the ST1PS02 datasheet for the voltage range configuration

Table 12. Solder bridge configurations and settings (continued)

Definition	Bridge	State ⁽¹⁾	Comment
ADP5301 U9 VID selection	SB83	ON	ADP5301 output voltage factory ADP5301 opt0 = 2.5 V ADP5301 Opt1 = 1.3 V
		OFF	ADP5301 output voltage defined by R39
ADP5301 U9 EN selection	SB84 / SB85	SB84 ON	ADP5301 EN pin driven by I/O: SMPS_EN PA4
		SB85 ON	ADP5301 always enabled (level 1)
ADP5301 mode selection	SB86 / SB95	SB86 ON	ADP5301 set in PWM mode (500 mA out, low efficiency)
		SB95 ON	ADP5301 set in hysteresis mode (50 mA out, best efficiency)
VDD_MCU selection	SB87	ON	V _{DD_MCU} connected to CN11 V _{OUT} V _{DD}
		OFF	V _{DD_MCU} not connected to CN11 V _{OUT} V _{DD}
SMPS_SW enable	SB88	ON	Switch driven by I/O SMPS_SW PA7
		OFF	Switch NOT driven by I/O, Switch driven by U12 pin 1 AUX or CN11 pin 5
ST1PS02 U12 voltage selection	SB89	ON	ST1PS02 U12 output selection by I/O SMPS_V1 PA5
		OFF	ST1PS02 U12 output fixed by solder bridge, or driven by U11 pin 4
SMPS U11/U12 enable	SB92	ON	SMPS U11/ U12 enabled pin driven by the I/O SMPS_EN PA4
		OFF	SMPS U11/ U12 NOT enabled by I/O. Enable pin level fixed by solder bridge or driven by CN11 pin 5
SMPS U11/U12 PWR GOOD	SB93	ON	SMPS U11/ U12 power good connected to SMPS_PG PA6 I/O
		OFF	SMPS U11/ U12 power good NOT connected to I/O , but a configuration is possible for CN11 pin 7 to drive it.

1. The default SBx state is shown in bold.

SB16, SB18, SB19, SB22, SB23, SB26, SB27, SB28, SB36, SB37, SB38, SB40, SB41, SB44, SB45, SB47, SB48, SB49, SB52, SB53, SB54, SB55, SB57, SB58, SB59, SB63, **are linked to the STM32 configuration. Do not modify them.**

All STM32 Nucleo-64-P boards are delivered with solder bridges configured according to the target STM32 supported.

7 Connectors

Eight connectors are implemented on the STM32 Nucleo-64-P board:

CN1: ST-LINK USB connector

CN7, CN8, CN9, and CN10: ARDUINO® Uno V3 connectors

CN5 and CN6: ST morpho connectors

CN11: External SMPS connector

7.1 USB Micro-B connector CN1

The USB connector CN1 is used to connect the embedded ST-LINK/V2-1 to the PC for programming and debugging the STM32 Nucleo-64-P board microcontroller.

Figure 14. USB Micro-B connector CN1 (front view)

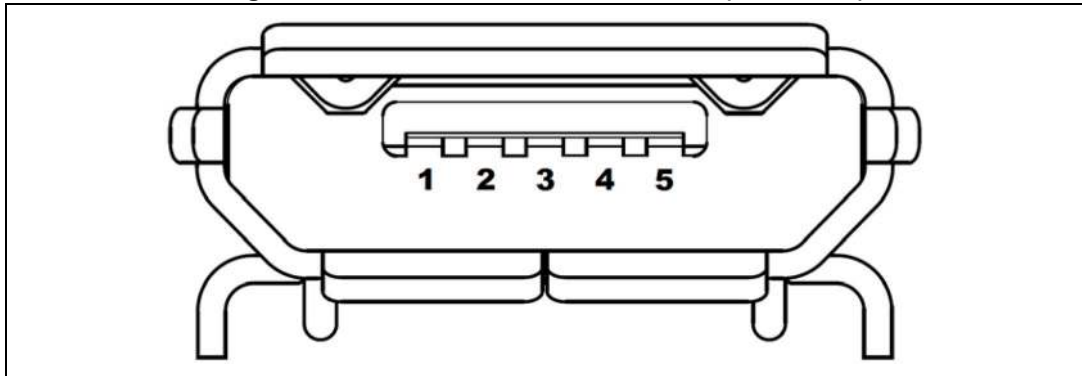

The related pinout for the USB ST-LINK connector is listed in [Table 13](#).

Table 13. USB Micro-B pinout

Connector	Pin number	Pin name	Signal name	ST-LINK MCU pin	Function
CN1	1	VBUS	5V_STLINK / 5V_USB_CHG	-	5 V power
	2	DM (D-)	STLINK_USB_D_N	PA11	USB diff pair M
	3	DP (D+)	STLINK_USB_D_P	PA12	USB diff pair P
	4	ID	-	-	-
	5	GND	-	-	GND

7.2 ARDUINO[®] Uno V3 connectors

The CN7, CN8, CN9, and CN10 ARDUINO[®] connectors (see [Figure 15](#)) are female connectors compatible with the ARDUINO[®] standard. Most shields designed for ARDUINO[®] can fit the STM32 Nucleo-64-P board.

The ARDUINO[®] connectors on the STM32 Nucleo-64-P board support the ARDUINO[®] Uno V3.

Figure 15. ARDUINO[®] connectors

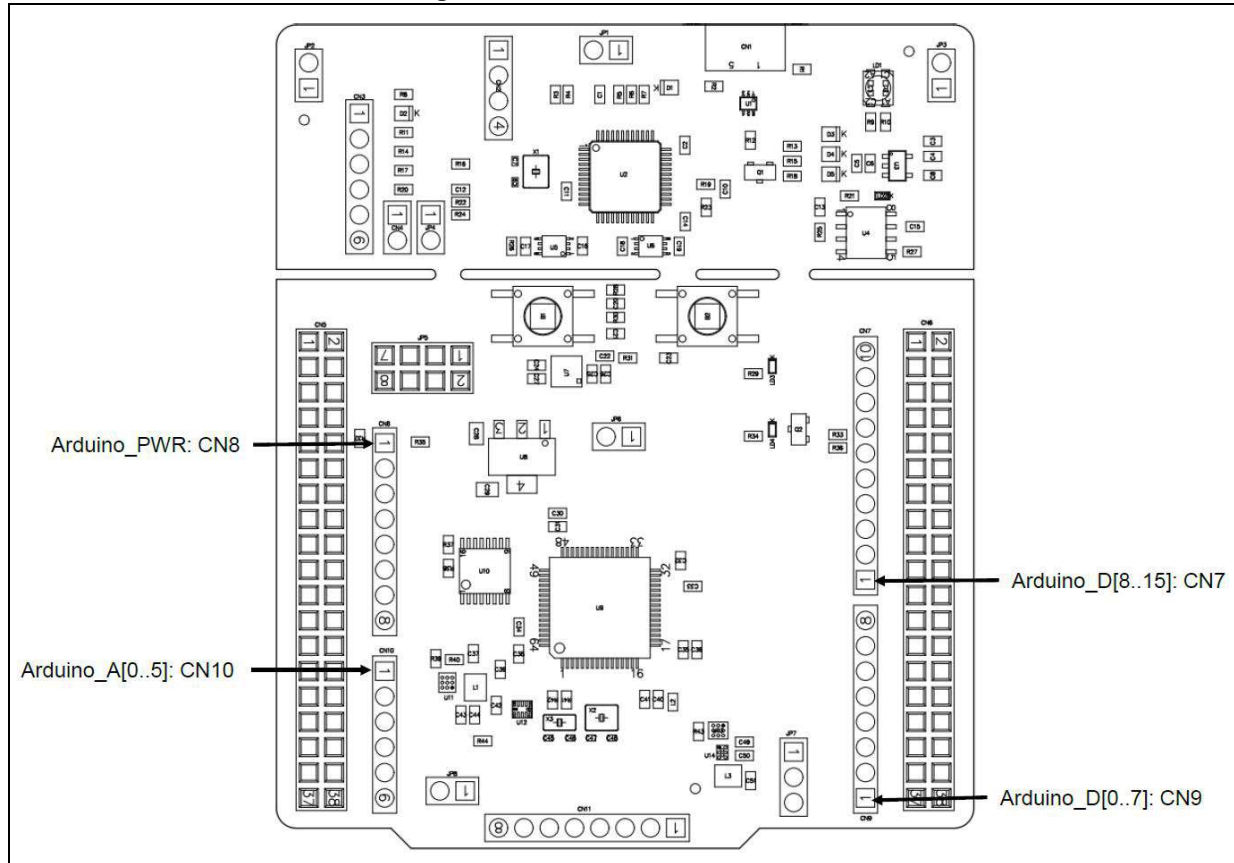

The related pinout for the ARDUINO[®] connector is shown in [Figure 16](#) and listed in [Table 14](#).

Figure 16. ARDUINO® connector pinout

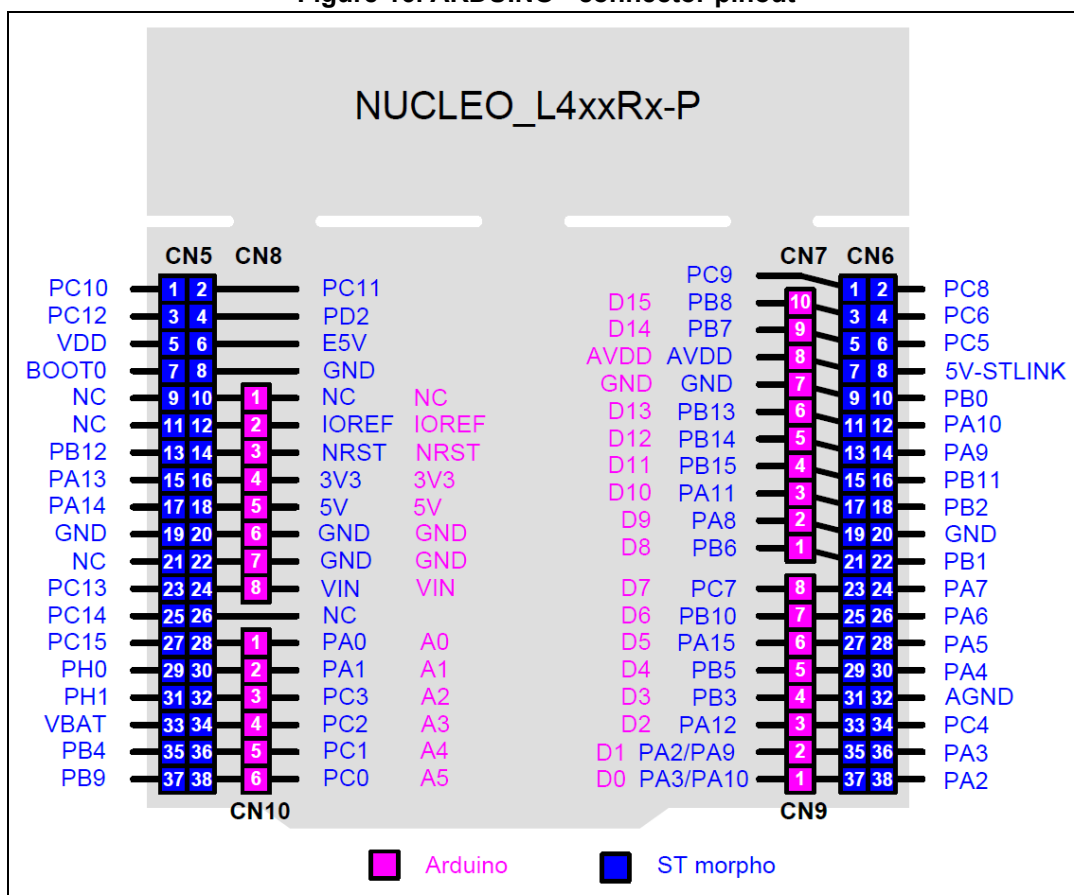

Note: ARDUINO® Uno V3 D0 and D1 signals are connected by default on USART1 (MCU I/O PA9 and PA10). For details about how to modify the UART interface, refer to [Section 6.9: Virtual COM port: LPUART1/USART1](#).

Table 14. ARDUINO® connector pinout

Connector	Pin number	Pin name	Signal name	STM32 pin	Function
CN8	1	NC	-	-	Reserved for test
	2	IOREF	-	-	I/O reference
	3	NRST	NRST	NRST	RESET
	4	3.3 V	-	-	3.3 V input/output
	5	5V	-	-	5 V output
	6	GND	-	-	GND
	7	GND	-	-	GND
	8	VIN	-	-	7-12 V power input

Table 14. ARDUINO® connector pinout (continued)

Connector	Pin number	Pin name	Signal name	STM32 pin	Function
CN10	1	A0	ADC	PA0	ADC1_IN5
	2	A1	ADC	PA1	ADC1_IN6
	3	A2	ADC	PC3	ADC1_IN4
	4	A3	ADC	PC2	ADC1_IN3
	5	A4	ADC	PC1	ADC1_IN2/I2C3_SDA
	6	A5	ADC	PC0	ADC1_IN1/I2C3_SCL
CN7	10	SCL/D15	ARD_D15	PB8	I2C1_SCL
	9	SDA/D14	ARD_D14	PB7	I2C1_SDA
	8	AVDD	VREF	-	VREF
	7	GND	-	-	Ground
	6	SCK/D13	ARD_D13	PB13	SPI2_SCK
	5	MISO/D12	ARD_D12	PB14	SPI2_MISO
	4	PWM/MOSI/D11	ARD_D11	PB15	TIM15_CH2/SPI2_MOSI
	3	PWM/CS/D10	ARD_D10	PA11	TIM1_CH4/SPIx_NSS
	2	PWM/D9	ARD_D9	PA8	TIM1_CH1
	1	D8	ARD_D8	PB6	IO
CN9	8	D7	ARD_D7	PC7	IO
	7	PWM/D6	ARD_D6	PB10	TIM2_CH3
	6	PWM/D5	ARD_D5	PA15	TIM2_CH1
	5	D4	ARD_D4	PB5	EXT_IT_5
	4	PWM/D3	ARD_D3	PB3	TIM2_CH2
	3	D2	ARD_D2	PA12	IO
	2	TX/D1	ARD_D1	PA2 / PA9	LPUSART1_TX / USART1_TX
	1	RX/D0	ARD_D0	PA3 / PA10	LPUSART1_RX / USART1_RX

7.3 ST morpho connectors CN5 and CN6

The ST morpho connectors CN5 and CN6 are male pin headers accessible on both sides of the STM32 Nucleo-64-P board (see [Figure 17](#)). All signals and power pins, except V_{DD_CORE} 1.2 V of the STM32, are available on the ST morpho connectors. An oscilloscope, logical analyzer, or voltmeter can also probe these connectors.

Figure 17. ST morpho connector

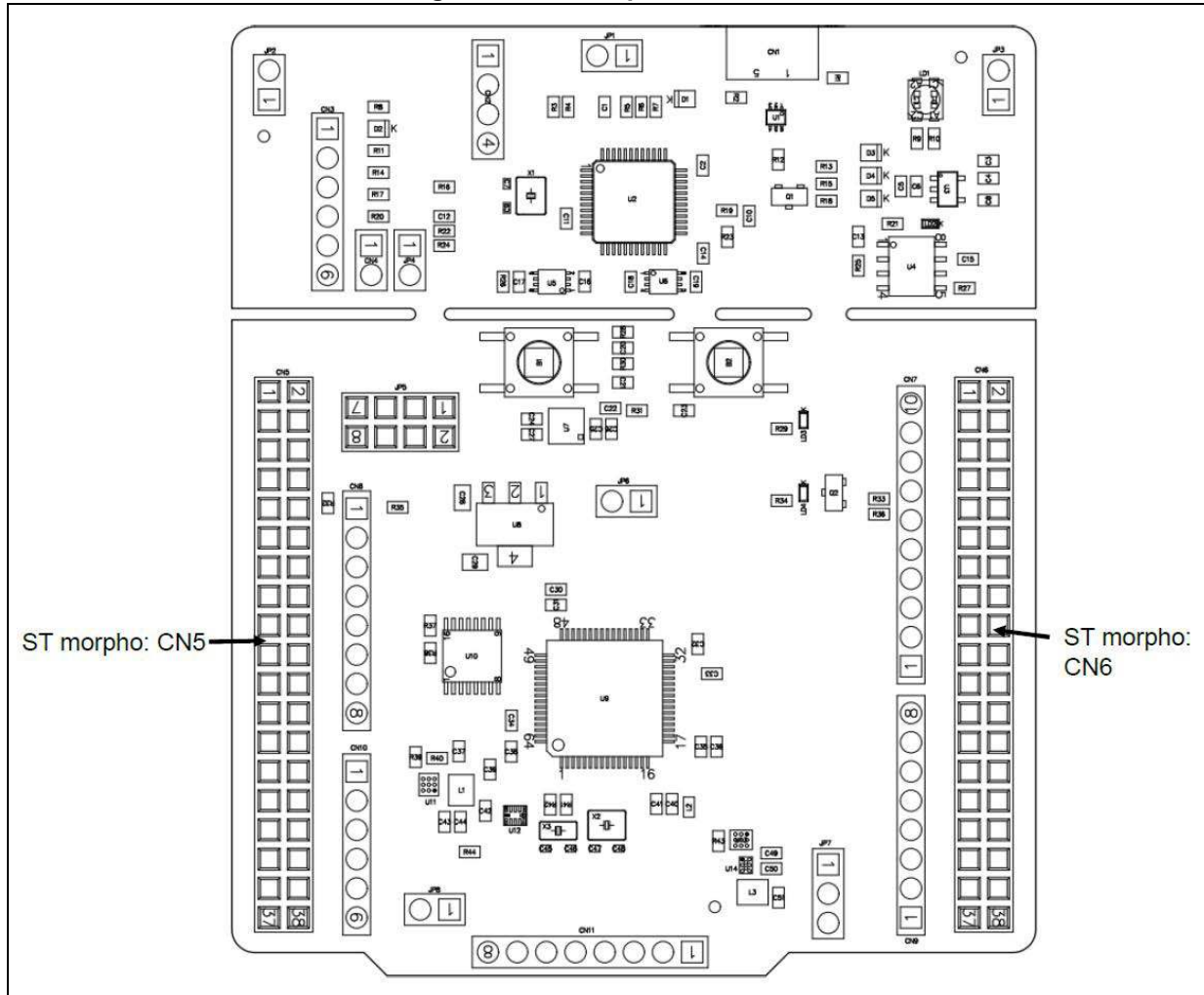

The related pinout and the MCU assignment for the ST morpho connector are listed in [Figure 18](#).

Figure 18. ST morpho connector pinout

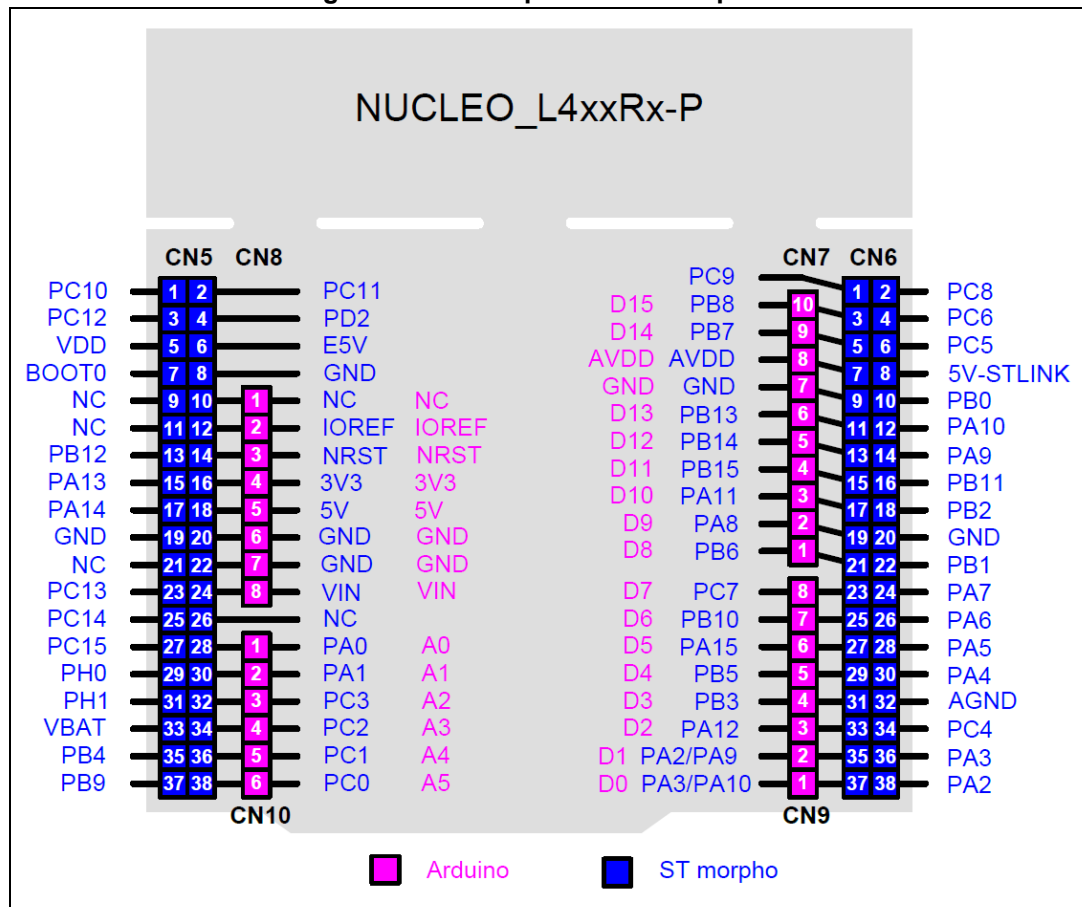

Note: ARDUINO® Uno V3 D0 and D1 signals are connected by default on USART1 (MCU I/O PA9 and PA10). Refer to [Section 6.9: Virtual COM port: LPUART1/USART1](#) for details about UART interface modification.

7.4 External power connector

The external power connector CN11 is an 8-pin, single-row, 2.54 mm-pitch connector. By default, this connector is not soldered. The PCB footprint gives the possibility to control easily the V_{core} logic and the V_{DD_MCU} power supply with an external source. The external power connector is shown in [Figure 19](#).

Figure 19. External power connector

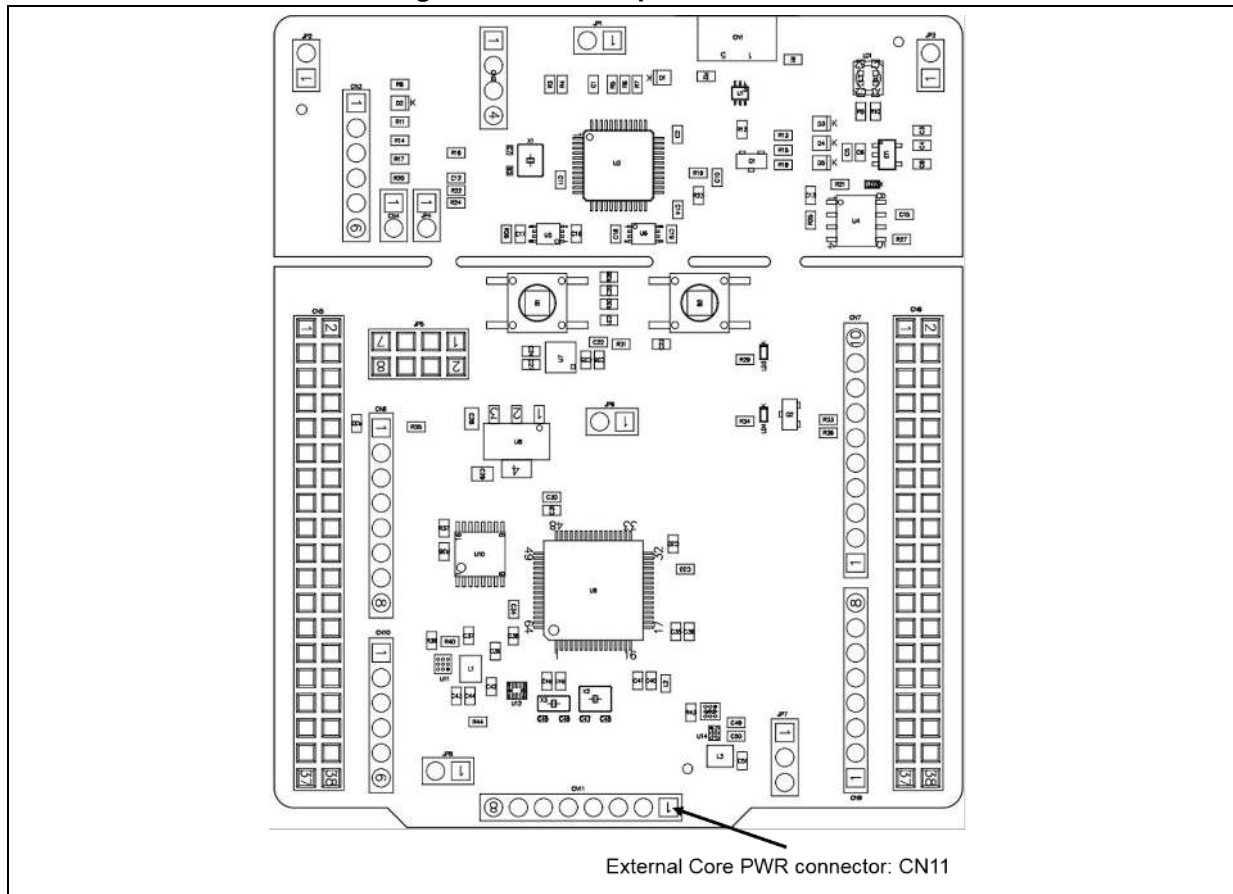

The related pinout for the external power connector is listed in [Table 15](#).

Table 15. External power connector pinout

Connector	Pin number	Signal name	STM32 pin	Function
CN11	1	V _{DD}	V _{DD}	V _{DD} @ 3.3 V supply
	2	V _{OUTCORE}	V _{DD_1V2}	MCU core PWR 1.2 V/1.1 V
	3	V _{OUTVDD}	V _{DD_MCU}	V _{DD_MCU} : 1.8 V / 3.3 V
	4	SMPS_V1	PA5	I/O for voltage selection
	5	SMPS_EN	PA4	I/O for SMPS enable
	6	SMPS_SW	PA7	I/O for switch control
	7	SMPS_PG	PA6	I/O for power good signal
	8	GND	GND	Ground

8 STM32 Nucleo-64-P board information

8.1 Product marking

The stickers located on the top or bottom side of the PCB provide product information:

Product order code and product identification for the first sticker

Board reference with revision, and serial number for the second sticker

On the first sticker, the first line provides the product order code, and the second line the product identification.

On the second sticker, the first line has the following format: "MBxxxx-Variant-yzz", where "MBxxxx" is the board reference, "Variant" (optional) identifies the mounting variant when several exist, "y" is the PCB revision and "zz" is the assembly revision, for example B01. The second line shows the board serial number used for traceability.

Evaluation tools marked as "ES" or "E" are not yet qualified and therefore not ready to be used as reference design or in production. Any consequences deriving from such usage will not be at ST charge. In no event, ST will be liable for any customer usage of these engineering sample tools as reference designs or in production.

"E" or "ES" marking examples of location:

On the targeted STM32 that is soldered on the board (For an illustration of STM32 marking, refer to the STM32 datasheet "Package information" paragraph at the www.st.com website).

Next to the evaluation tool ordering part number that is stuck or silk-screen printed on the board.

Some boards feature a specific STM32 device version, which allows the operation of any bundled commercial stack/library available. This STM32 device shows a "U" marking option at the end of the standard part number and is not available for sales.

To use the same commercial stack in their applications, the developers may need to purchase a part number specific to this stack/library. The price of those part numbers includes the stack/library royalties.

8.2 NUCLEO-L412RB-P product history

8.2.1 Product identification NUL412RBP\$AU1

This product identification is based on the MB1319-L412RB-C01 mother board.

It embeds the STM32L412RBT6P microcontroller with silicon revision code "A". The limitations of this silicon revision are detailed in the errata sheet *STM32L412xx device errata* (ES0456).

8.2.2 Product identification NUL412RBP\$AU2

This product identification is based on the MB1319-L412RB-C02 mother board.

It embeds the STM32L412RBT6P microcontroller with silicon revision code "A". The limitations of this silicon revision are detailed in the errata sheet *STM32L412xx device errata* (ES0456).

8.3 NUCLEO-L412RB-P product limitations

8.3.1 Product identification NUL412RBP\$AU1 limitations

No limitation identified for this product identification.

8.3.2 Product identification NUL412RBP\$AU2 limitations

No limitation identified for this product identification.

8.4 NUCLEO-L433RC-P product history

8.4.1 Product identification NUCLEOL433RCP/

This product identification is based on the MB1319-L433RC-C01 mother board.

It embeds the STM32L433RCT6P microcontroller with silicon revision code "Z". The limitations of this silicon revision are detailed in the errata sheet *STM32L433xx/443xx device errata* (ES0318).

8.4.2 Product identification NUL433RCP\$AU1

This product identification is based on the MB1319-L433RC-C02 mother board.

It embeds the STM32L433RCT6P microcontroller with silicon revision code "Z". The limitations of this silicon revision are detailed in the errata sheet *STM32L433xx/443xx device errata* (ES0318).

8.5 NUCLEO-L433RC-P product limitations

8.5.1 Product identification NUCLEOL433RCP/ limitations

No limitation identified for this product identification.

8.5.2 Product identification NUL433RCP\$AU1 limitations

No limitation identified for this product identification.

8.6 NUCLEO-L452RE-P product history

8.6.1 Product identification NUCLEOL452REP/

This product identification is based on the MB1319-L452RE-C01 mother board.

It embeds the STM32L452RET6P microcontroller with silicon revision code "Y". The limitations of this silicon revision are detailed in the errata sheet *STM32L452xx device errata* (ES0388).

8.6.2 Product identification NUL452REP\$AU1

This product identification is based on the MB1319-L452RE-C02 mother board.

It embeds the STM32L452RET6P microcontroller with silicon revision code "Y". The limitations of this silicon revision are detailed in the errata sheet *STM32L452xx device errata* (ES0388).

8.7 NUCLEO-L452RE-P product limitations

8.7.1 Product identification NUCLEOL452REP/ limitations

No limitation identified for this product identification.

8.7.2 Product identification NUL452REP\$AU1 limitations

No limitation identified for this product identification.

8.8 Board revision history

8.8.1 MB1319 revision B-02

The revision B-02 of the MB1319 is the initially released version.

8.8.2 MB1319 revision C-01

Addition of two solder bridges (SB96 and SB97) to support the optional configuration with U12: ST1PS02D1QTR IC.

8.8.3 MB1319 revision C-02

Replacement of LEDs and capacitor references.

8.9 Board known limitations

8.9.1 Board MB1319 revision B-02 limitations

No limitation identified for this board revision.

8.9.2 Board MB1319 revision C-01 limitations

No limitation identified for this board revision.

8.9.3 Board MB1319 revision C-02 limitations

No limitation identified for this board revision.

9 NUCLEO-L412RB-P, NUCLEO-L433RC-P, and NUCLEO-L452RE-P I/O assignment

Table 16. NUCLEO-L412RB-P, NUCLEO-L433RC-P, and NUCLEO-L452RE-P I/O assignment

Pin No.	Pin name	Signal or label	Main feature / optional feature (SB)
1	V _{BAT}	V _{BAT}	PWR V _{BAT}
2	PC13	PC13	User button / I/O
3	PC14-OSC32_IN	OSC32_IN / PC14	LSE CLK / I/O
4	PC15-OSC32_OUT	OSC32_OUT / PC15	LSE CLK / IO
5	PH0-OSC_IN	OSC_IN / PH0	I/O / HSE CLK
6	PH1-OSC_OUT	OSC_OUT / PH1	I/O / HSE CLK
7	NRST	NRST	RESET
8	PC0	PC0	ARD_A5 - ADC1_IN1 / I2C3_SCL / IO
9	PC1	PC1	ARD_A4 - ADC1_IN2 / I2C3_SDA / IO
10	PC2	PC2	ARD_A3 - ADC1_IN3 / IO
11	PC3	PC3	ARD_A2 - ADC1_IN4 / IO
12	VSSA	GND	PWR GND
13	V _{DDA} /V _{REF+}	AVDD	PWR AVDD
14	PA0	PA0	ARD_A0 - ADC1_IN5 / user button
15	PA1	PA1	ARD_A1 - ADC1_IN6
16	PA2	LPUART1_TX	STLINK_TX / ARD_D1_TX
17	PA3	LPUART1_RX	STLINK_RX / ARD_D0_RX
18	V _{SS}	GND	PWR GND
19	V _{DD}	VDD_MCU	PWR V _{DD_MCU} 1.8 V / 3.3 V
20	PA4	PA4	SMPS_EN / IO
21	PA5	PA5	SMPS_V1 / IO
22	PA6	PA6	SMPS_PG / IO
23	PA7	PA7	SMPS_SW / IO
24	PC4	PC4	I/O
25	PB0	PB0	I/O
26	PB1	PB1	I/O
27	PB2	PB2	PB2
28	PB10	PB10	ARD_D6 / TIM2_CH3
29	PB11	PB11	I/O
30	V _{DD1V2}	V _{DD12}	PWR ExtSMPS 1V1

Table 16. NUCLEO-L412RB-P, NUCLEO-L433RC-P, and NUCLEO-L452RE-P I/O assignment (continued)

Pin No.	Pin name	Signal or label	Main feature / optional feature (SB)
31	V _{SS}	GND	PWR GND
32	V _{DD}	V _{DD_MCU}	PWR V _{DD_MCU} 1.8 V / 3.3 V
33	PB12	PB12	I/O
34	PB13	PB13	ARD_D13 - SPI2_SCK / LED / IO
35	PB14	PB14	ARD_D12 - SPI2_MISO / IO
36	PB15	PB15	ARD_D11 - SPI2_MOSI - TIM15_CH2 / I/O
37	PC6	PC6	I/O
38	PC7	PC7	ARD_D7 / IO
39	PC8	PC8	I/O
40	PC9	PC9	I/O
41	PA8	PA8	ARD_D9 - TIM1_CH1 / IO
42	PA9	UART1_TX	ARD_D1_TX / STLINK_TX
43	PA10	UART1_RX	ARD_D0_RX / STLINK_RX
44	PA11	PA11	ARD_D10 - TIM1_CH4 - SPIx-CS / IO
45	PA12	PA12	ARD_D2 / IO
46	PA13	PA13	TMS_SWDIO
47	V _{SSUSB}	GND	PWR GND
48	V _{DDUSB}	V _{DD_MCU} / V _{DD}	PWR V _{DD_MCU} 1.8 V / 3.3 V
49	PA14	PA14	TCK_SWCLK
50	PA15	PA15	ARD_D5 - TIM2_CH1 / IO
51	PC10	PC10	I/O
52	PC11	PC11	I/O
53	PC12	PC12	I/O
54	PB3	PB3	ARD_D3 - TIM2_CH2 / SWO
55	PB4	PB4	I/O
56	PB5	PB5	ARD_D4 / IT5
57	PB6	PB6	ARD_D8 / IO
58	PB7	PB7	ARD_D14 - I2C1_SDA / IO
59	PH3-BOOT0	BOOT0	BOOT0
60	PB8	PB8	ARD_D15 - I2C1_SCL / IO
61	PB9	PB9	I/O
62	V _{DD1V2}	V _{DD12}	PWR ExtSMPS 1.1 V

Table 16. NUCLEO-L412RB-P, NUCLEO-L433RC-P, and NUCLEO-L452RE-P I/O assignment (continued)

Pin No.	Pin name	Signal or label	Main feature / optional feature (SB)
63	V _{SS}	GND	PWR GND
64	V _{DD}	V _{DD_MCU}	PWR V _{DD_MCU} 1.8 V / 3.3 V

10 Federal Communications Commission (FCC) and ISED Canada Compliance

10.1 FCC Compliance Statement

10.1.1 Part 15.19

This device complies with part 15 of the FCC Rules. Operation is subject to the following two conditions: (1) this device may not cause harmful interference, and (2) this device must accept any interference received, including interference that may cause undesired operation.

10.1.2 Part 15.21

Any changes or modifications to this equipment not expressly approved by STMicroelectronics may cause harmful interference and void the user's authority to operate this equipment.

10.1.3 Part 15.105

This equipment has been tested and found to comply with the limits for a Class B digital device, pursuant to part 15 of the FCC Rules. These limits are designed to provide reasonable protection against harmful interference in a residential installation. This equipment generates uses and can radiate radio frequency energy and, if not installed and used in accordance with the instruction, may cause harmful interference to radio communications. However, there is no guarantee that interference will not occur in a particular installation. If this equipment does cause harmful interference to radio or television reception which can be determined by turning the equipment off and on, the user is encouraged to try to correct interference by one or more of the following measures:

- Reorient or relocate the receiving antenna.

- Increase the separation between the equipment and receiver.

- Connect the equipment into an outlet on circuit different from that to which the receiver is connected.

- Consult the dealer or an experienced radio/TV technician for help.

Responsible party (in the USA)

Terry Blanchard

Americas Region Legal | Group Vice President and Regional Legal Counsel, The Americas STMicroelectronics, Inc.

750 Canyon Drive | Suite 300 | Coppell, Texas 75019

USA

Telephone: +1 972-466-7845

10.2 ISED Canada Compliance Statement

This device complies with FCC and ISED Canada RF radiation exposure limits set forth for general population for mobile application (uncontrolled exposure). This device must not be collocated or operating in conjunction with any other antenna or transmitter.

10.2.1 Compliance Statement

Notice: This device complies with Innovation, Science and Economic Development Canada's licence-exempt RSS standard(s). Operation is subject to the following two conditions: (1) this device may not cause interference, and (2) this device must accept any interference, including interference that may cause undesired operation of the device.

ISED Canada ICES-003 Compliance Label: CAN ICES-3 (B) / NMB-3 (B).

10.2.2 Déclaration de conformité

Avis: Le présent appareil est conforme aux CNR d'Innovation, Sciences et Développement Économique Canada applicables aux appareils radio exempts de licence. L'exploitation est autorisée aux deux conditions suivantes : (1) l'appareil ne doit pas produire de brouillage, et (2) l'utilisateur de l'appareil doit accepter tout brouillage radioélectrique subi, même si le brouillage est susceptible d'en compromettre le fonctionnement.

Étiquette de conformité à la NMB-003 d'ISDE Canada : CAN ICES-3 (B) / NMB-3 (B).

11 CE / RED

11.1 EN55032 / CISPR32

Warning: This device is compliant with Class B of EN55032 / CISPR32. In a residential environment, this equipment may cause radio interference.

Avertissement: Cet équipement est conforme à la Classe B de la EN55032 / CISPR32. Dans un environnement résidentiel, cet équipement peut créer des interférences radio.

Revision history

Table 17. Document revision history

Date	Revision	Changes
8-Jun-2017	1	Initial release.
6-Sep-2017	2	Updated Appendix C: Federal Communications Commission (FCC) and Industry Canada (IC) Compliance and Section Appendix D: CISPR32 .
23-Aug-2018	3	Extended document scope to the NUCLEO-L412RB-P board: updated Introduction , Table 1: Ordering information , ST1PS02 voltage selection in Table 12: Solder bridge configurations and settings , and Table 16: NUCLEO-L412RB-P, NUCLEO-L433RC-P, and NUCLEO-L452RE-P I/O assignment . Updated Section 2: Product marking . Updated schematics from Figure 20 to Figure 26 for board revision C-01.
3-Apr-2020	4	Updated UART1_TX/SB35 description in Table 12: Solder bridge configurations and settings . Removed Electrical schematics . Reorganized the beginning of the document: – Updated document title – Updated Features , Ordering information , and Development toolchains – Added Product marking and Codification
15-Dec-2020	5	Updated Section 6.7.2: OSC clock supply with R19 and C10 values for the MCO from ST-LINK configuration. Added Section 8: STM32 Nucleo-64-P board information including Section 8.1: Product marking . Updated Section 3: Development environment .
24-Jun-2022	6	Updated Section 8: STM32 Nucleo-64-P board information with added Section 8.2: NUCLEO-L412RB-P product history to Section 8.7: NUCLEO-L452RE-P product limitations . Removed the references to Arm® Mbed™ and Demonstration software section.

IMPORTANT NOTICE – READ CAREFULLY

STMicroelectronics NV and its subsidiaries (“ST”) reserve the right to make changes, corrections, enhancements, modifications, and improvements to ST products and/or to this document at any time without notice. Purchasers should obtain the latest relevant information on ST products before placing orders. ST products are sold pursuant to ST’s terms and conditions of sale in place at the time of order acknowledgment.

Purchasers are solely responsible for the choice, selection, and use of ST products and ST assumes no liability for application assistance or the design of purchasers’ products.

No license, express or implied, to any intellectual property right is granted by ST herein.

Resale of ST products with provisions different from the information set forth herein shall void any warranty granted by ST for such product.

ST and the ST logo are trademarks of ST. For additional information about ST trademarks, refer to www.st.com/trademarks. All other product or service names are the property of their respective owners.

Information in this document supersedes and replaces information previously supplied in any prior versions of this document.

© 2022 STMicroelectronics – All rights reserved