

v02.0711

GaAs pHEMT MMIC 2 WATT POWER AMPLIFIER SMT WITH POWER DETECTOR, 12.5 - 15.5 GHz



Typical Applications

The HMC965LP5E is ideal for:

- Point-to-Point Radios
- Point-to-Multi-Point Radios
- VSAT & SATCOM
- Military & Space

Features

- Saturated Output Power: +34 dBm @ 20% PAE
- High Output IP3: +40 dBm
- High Gain: 27 dB
- DC Supply: +6V @ 1200 mA
- No External Matching Required

Functional Diagram

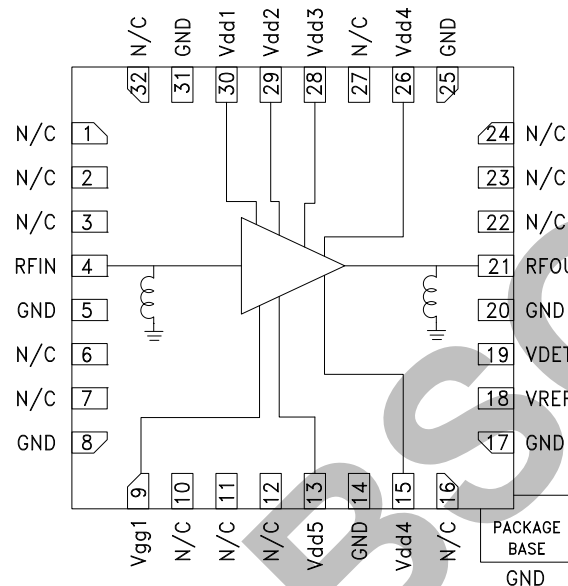

General Description

The HMC965LP5E is a 4 stage GaAs pHEMT MMIC 2 Watt Power Amplifier with an integrated temperature compensated on-chip power detector which operates between 12.5 and 15.5 GHz. The HMC965LP5E provides 27 dB of gain, +34 dBm of saturated output power, and 20% PAE from a +6V supply. The HMC965LP5E exhibits excellent linearity and is optimized for high capacity digital microwave radio. It is also ideal for 13.75 to 14.5 GHz Ku Band VSAT transmitters as well as SATCOM applications. The HMC965LP5E amplifier I/Os are internally matched to 50 Ohms and is packaged in a leadless QFN 5x5 mm surface mount package and requires no external matching components.

Electrical Specifications

$T_A = +25^\circ\text{C}$, $V_{dd} = V_{dd1} = V_{dd2} = V_{dd3} = V_{dd4} = V_{dd5} = +6\text{V}$, $I_{dd} = 1200\text{ mA}$ [1]

Parameter	Min.	Typ.	Max.	Units
Frequency Range		12.5 - 15.5		GHz
Gain [3]	24	27		dB
Gain Variation Over Temperature		0.05		dB/°C
Input Return Loss		12		dB
Output Return Loss		12		dB
Output Power for 1 dB Compression (P1dB)	30	32		dBm
Saturated Output Power (P _{sat})		34		dBm
Output Third Order Intercept (IP3) ^[2]		40		dBm
Total Supply Current (I _{dd})		1200		mA

[1] Adjust V_{gg} between -2 to 0V to achieve I_{dd} = 1200mA typical.
 [2] Measurement taken at +6V @ 1200 mA, P_{out} / Tone = +22 dBm
 [3] Board loss subtracted out



**GaAs pHEMT MMIC 2 WATT POWER AMPLIFIER SMT
WITH POWER DETECTOR, 12.5 - 15.5 GHz**

**Broadband Gain &
Return Loss vs. Frequency [1]**

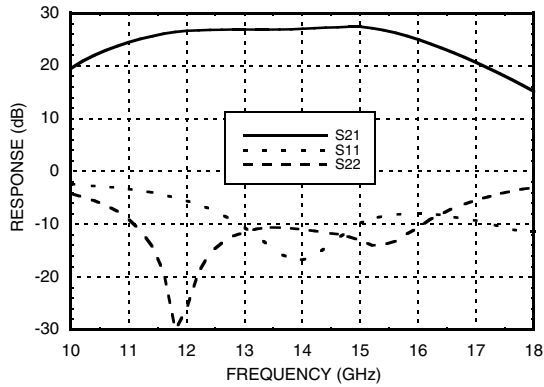

Gain vs. Temperature [1]

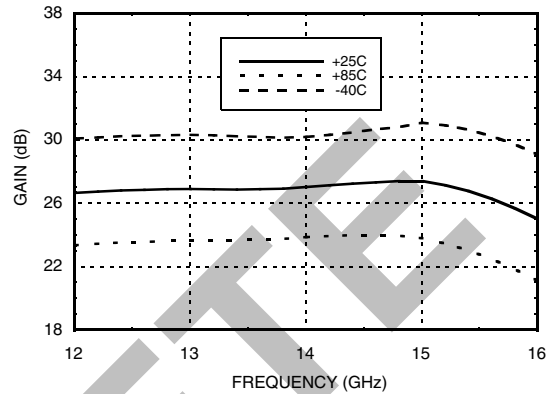

Input Return Loss vs. Temperature

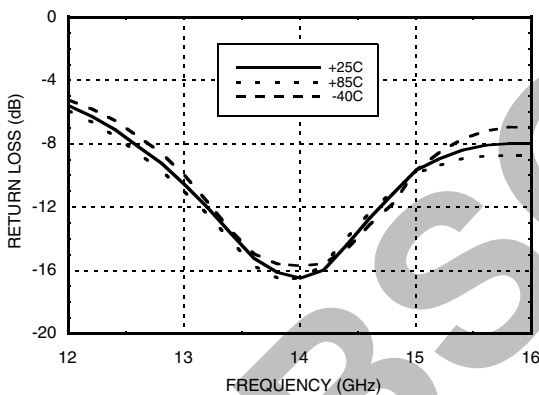

Output Return Loss vs. Temperature

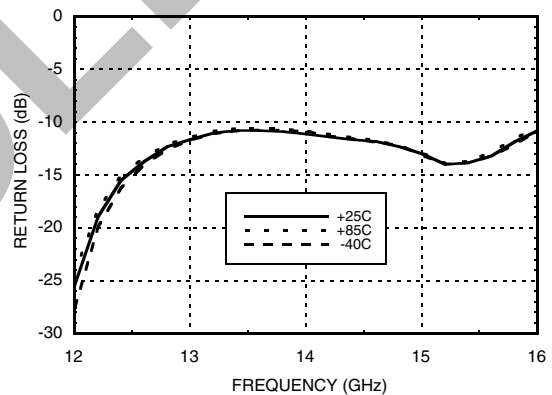

P1dB vs. Temperature

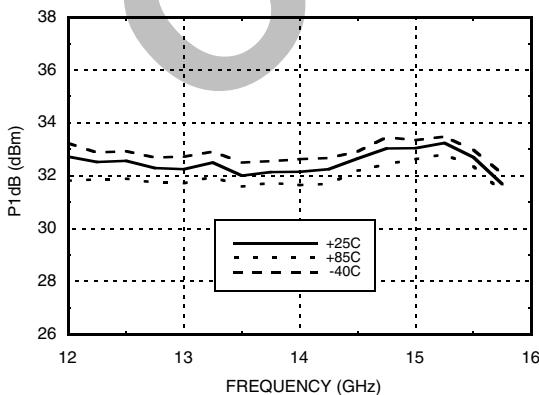

P1dB vs. Supply Voltage

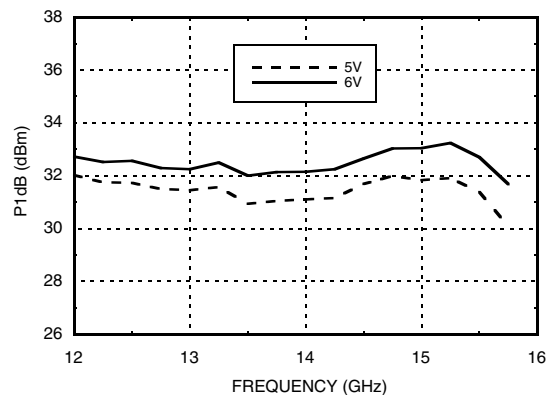

[1] Board loss subtracted out



GaAs pHEMT MMIC 2 WATT POWER AMPLIFIER SMT WITH POWER DETECTOR, 12.5 - 15.5 GHz

Psat vs. Temperature

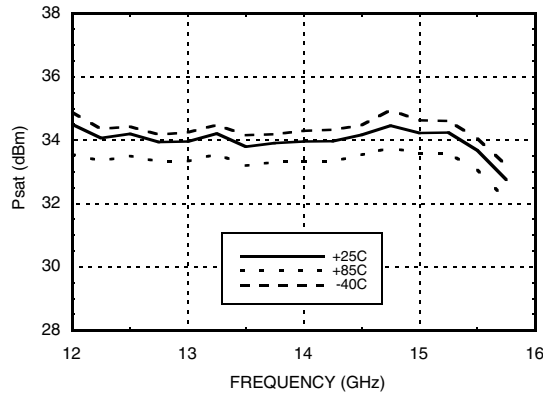

Psat vs. Supply Voltage

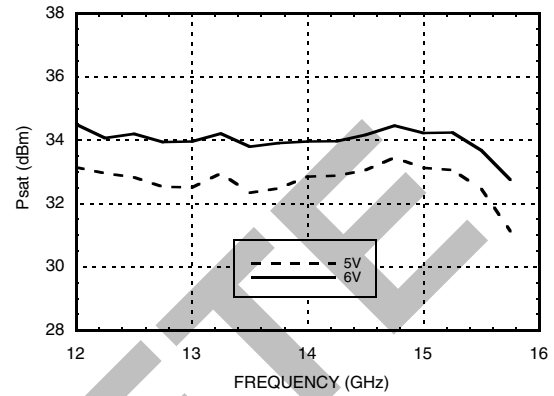

P1dB vs. Supply Current (Idd)

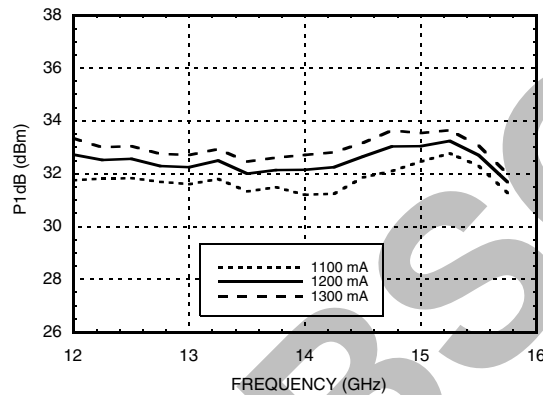

Psat vs. Supply Current (Idd)

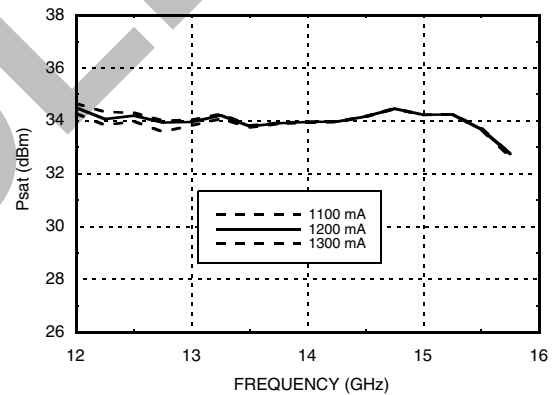

Output IP3 vs. Temperature, Pout/Tone = +22 dBm

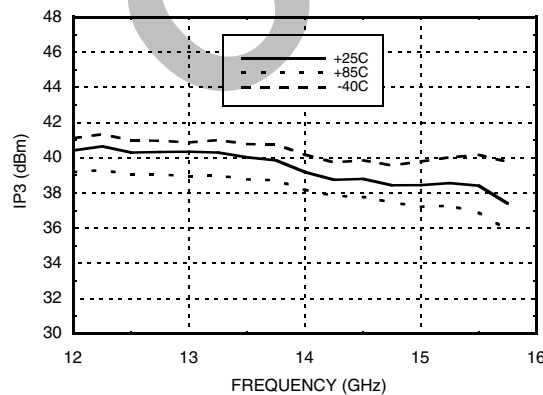

Output IP3 vs. Supply Current, Pout/Tone = +22 dBm

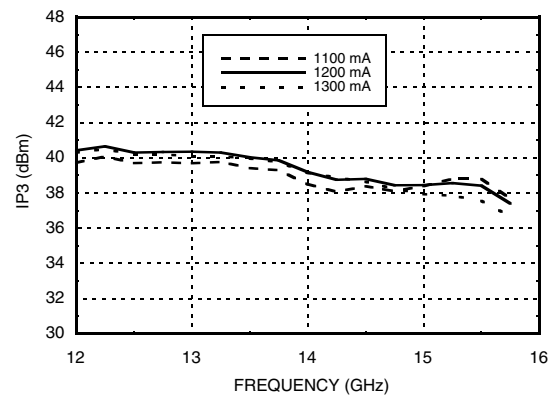

Information furnished by Analog Devices is believed to be accurate and reliable. However, no responsibility is assumed by Analog Devices for its use, nor for any infringements of patents or other rights of third parties that may result from its use. Specifications subject to change without notice. No license is granted by implication or otherwise under any patent or patent rights of Analog Devices. Trademarks and registered trademarks are the property of their respective owners.

For price, delivery, and to place orders: Analog Devices, Inc., One Technology Way, P.O. Box 9106, Norwood, MA 02062-9106 Phone: 781-329-4700 • Order online at www.analog.com Application Support: Phone: 1-800-ANALOG-D



GaAs pHEMT MMIC 2 WATT POWER AMPLIFIER SMT WITH POWER DETECTOR, 12.5 - 15.5 GHz

Output IP3 vs. Supply Voltage, Pout/Tone = +22 dBm

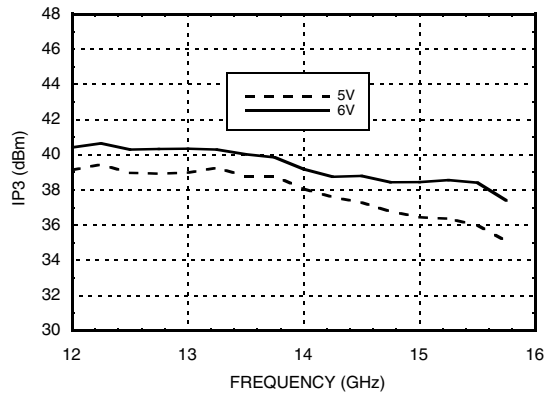

Output IM3 @ Vdd = +5V

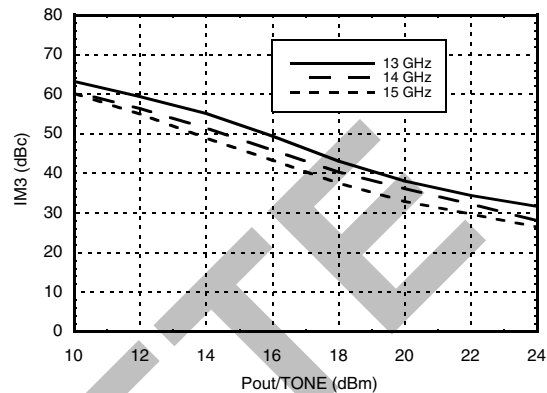

Output IM3 @ Vdd = +6V

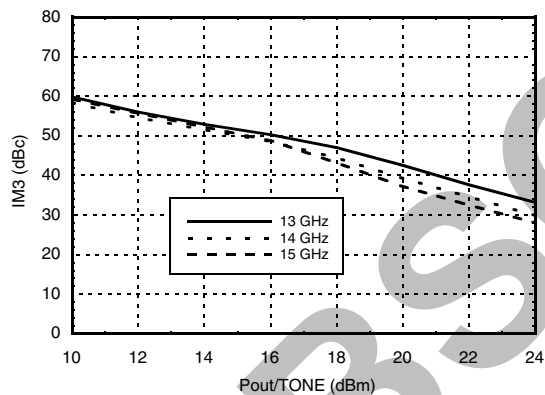

Power Compression @ 14 GHz

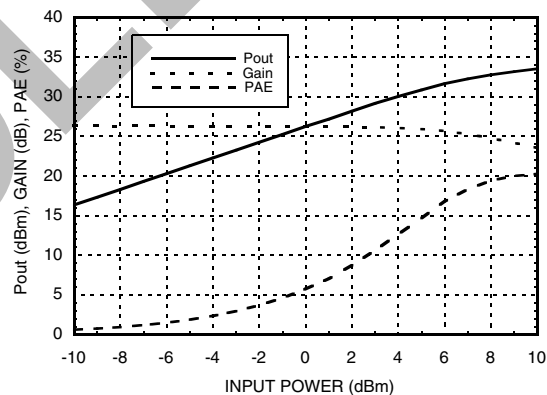

Detector Voltage Over Temperature

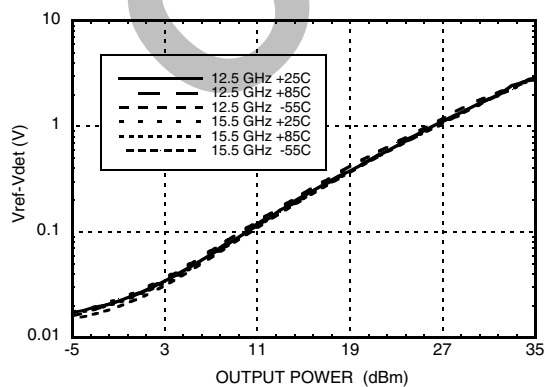

Reverse isolation vs. Temperature

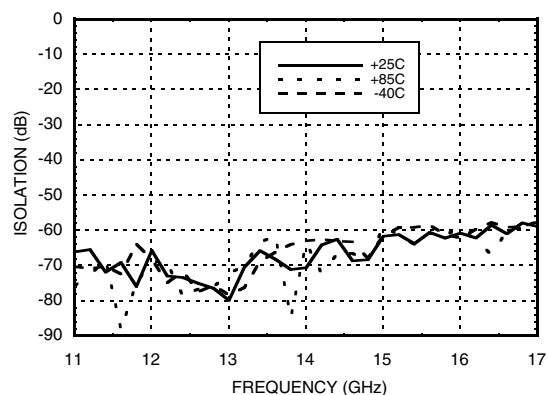

Information furnished by Analog Devices is believed to be accurate and reliable. However, no responsibility is assumed by Analog Devices for its use, nor for any infringements of patents or other rights of third parties that may result from its use. Specifications subject to change without notice. No license is granted by implication or otherwise under any patent or patent rights of Analog Devices. Trademarks and registered trademarks are the property of their respective owners.

For price, delivery, and to place orders: Analog Devices, Inc., One Technology Way, P.O. Box 9106, Norwood, MA 02062-9106 Phone: 781-329-4700 • Order online at www.analog.com Application Support: Phone: 1-800-ANALOG-D



GaAs pHEMT MMIC 2 WATT POWER AMPLIFIER SMT WITH POWER DETECTOR, 12.5 - 15.5 GHz

Gain & Power vs. Supply Current @ 14 GHz

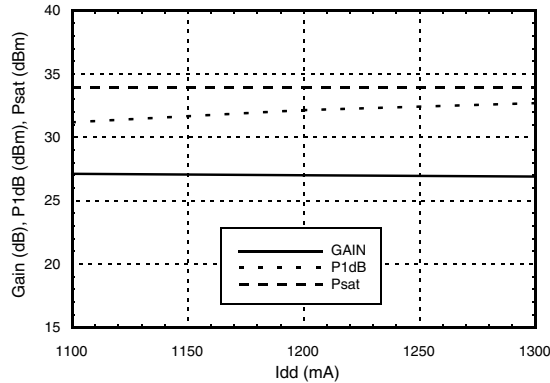

Gain & Power vs. Supply Voltage @ 14 GHz

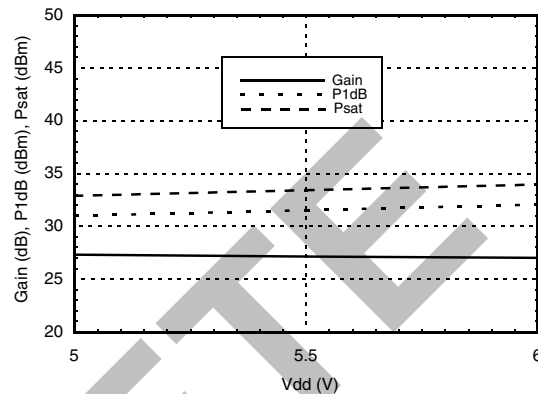

Power Dissipation

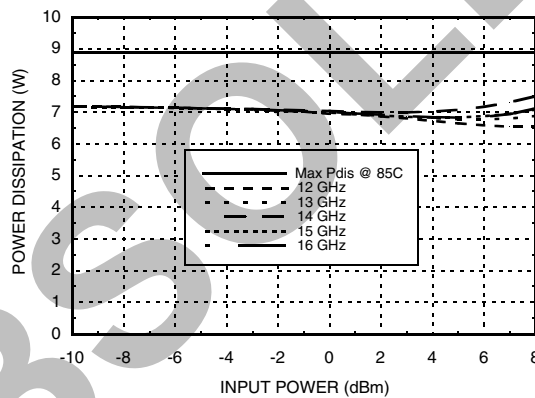

Absolute Maximum Ratings

Drain Bias Voltage (Vdd)	+8V
RF Input Power (RFIN)	+24 dBm
Channel Temperature	150 °C
Continuous Pdiss (T= 85 °C) (derate 137 mW/°C above 85 °C)	8.9 W
Thermal Resistance (channel to ground paddle)	7.3 °C/W
Storage Temperature	-65 to +150 °C
Operating Temperature	-55 to +85 °C
ESD Sensitivity (HBM)	Class 1A

Typical Supply Current vs. Vdd

Vdd (V)	Idd (mA)
+5.0	1200
+6.0	1200

Note: Amplifier will operate over full voltage ranges shown above. Vgg adjusted to achieve Idd = 1200 mA.



**ELECTROSTATIC SENSITIVE DEVICE
OBSERVE HANDLING PRECAUTIONS**



GaAs pHEMT MMIC 2 WATT POWER AMPLIFIER SMT WITH POWER DETECTOR, 12.5 - 15.5 GHz

Outline Drawing

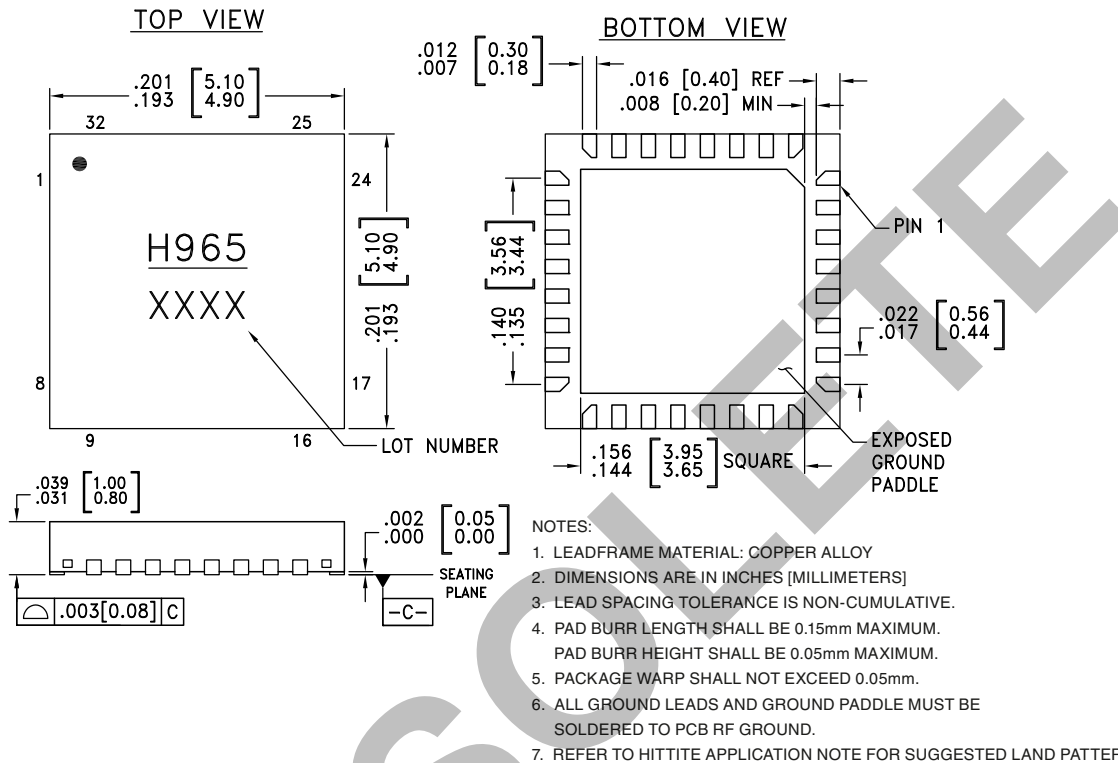

Package Information

Part Number	Package Body Material	Lead Finish	MSL Rating	Package Marking ^[1]
HMC965LP5E	RoHS-compliant Low Stress Injection Molded Plastic	100% matte Sn	MSL1 ^[2]	H965 XXXX

[1] 4-Digit lot number XXXX

[2] Max peak reflow temperature of 260 °C

Pin Descriptions

Pin Number	Function	Description	Interface Schematic
1 - 3, 6, 7, 10 - 12, 16, 22 - 24, 27, 32	N/C	These pins are not connected internally, however all data shown herein was measured with these pins connected to RF/DC ground externally.	
4	RFIN	This pad is DC coupled and matched to 50 Ohms.	
5, 8, 14, 17, 20, 25, 31	GND	These pins and package bottom must be connected to RF/DC ground.	
9	Vgg1	Gate control for amplifier. External bypass capacitors of 100 pF, 10 nF and 4.7 uF are required.	



GaAs pHEMT MMIC 2 WATT POWER AMPLIFIER SMT WITH POWER DETECTOR, 12.5 - 15.5 GHz

Pin Descriptions (continued)

Pin Number	Function	Description	Interface Schematic
13, 15, 26, 28 - 30	Vdd5, Vdd4, Vdd4, Vdd3, Vdd2, Vdd1	Drain bias voltage for the amplifier. External bypass capacitors of 100pF, 10nF and 4.7μF capacitors are required. Pins 15 and 26 are connected internally Vdd4 may be applied to either pin 15 or pin 26	
18	Vref	DC voltage of diode biased through external resistor, used for temperature compensation of Vdet.	
19	Vdet	DC voltage representing RF output power rectified by diode which is biased through an external resistor.	
21	RFOUT	This pin is DC coupled and matched to 50 Ohms.	

Application Circuit

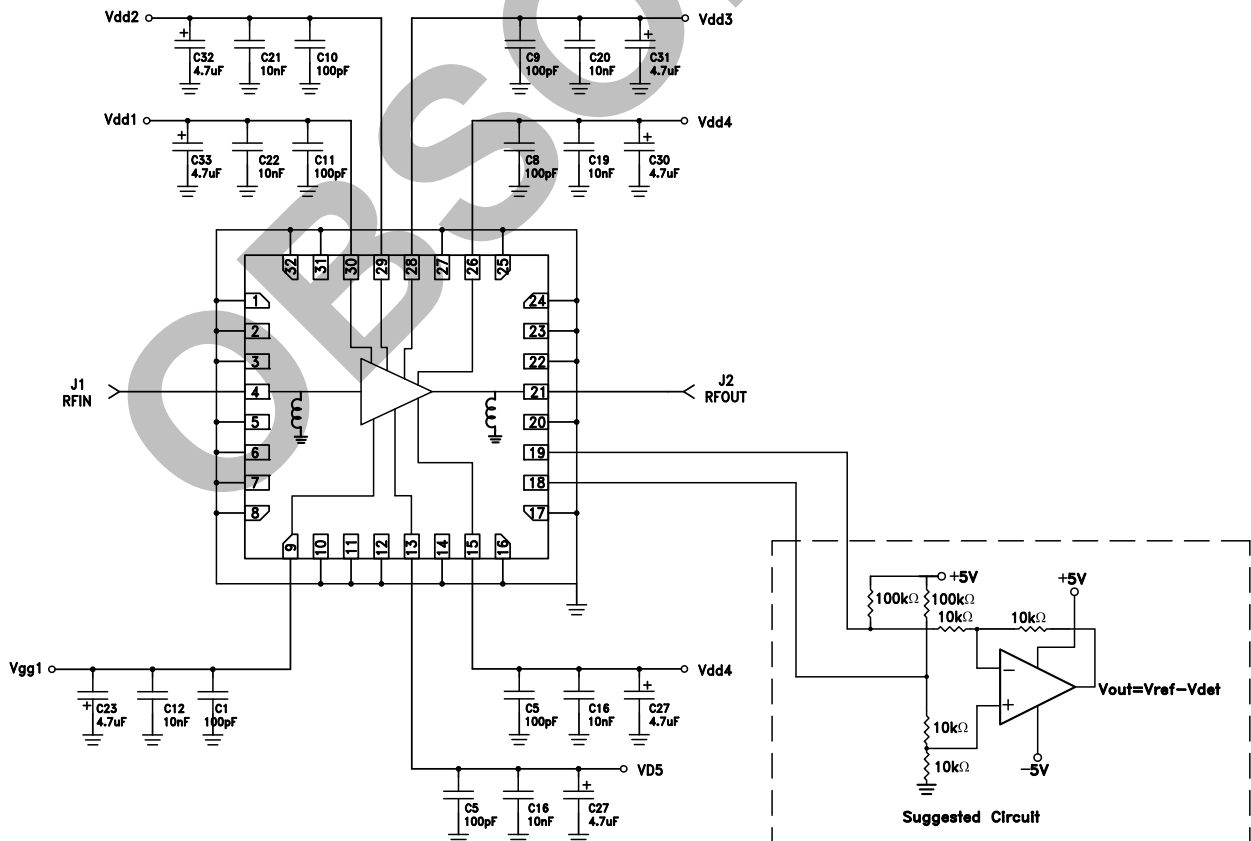

Information furnished by Analog Devices is believed to be accurate and reliable. However, no responsibility is assumed by Analog Devices for its use, nor for any infringements of patents or other rights of third parties that may result from its use. Specifications subject to change without notice. No license is granted by implication or otherwise under any patent or patent rights of Analog Devices. Trademarks and registered trademarks are the property of their respective owners.

For price, delivery, and to place orders: Analog Devices, Inc., One Technology Way, P.O. Box 9106, Norwood, MA 02062-9106 Phone: 781-329-4700 • Order online at www.analog.com Application Support: Phone: 1-800-ANALOG-D

**GaAs pHEMT MMIC 2 WATT POWER AMPLIFIER SMT
WITH POWER DETECTOR, 12.5 - 15.5 GHz**



Evaluation PCB

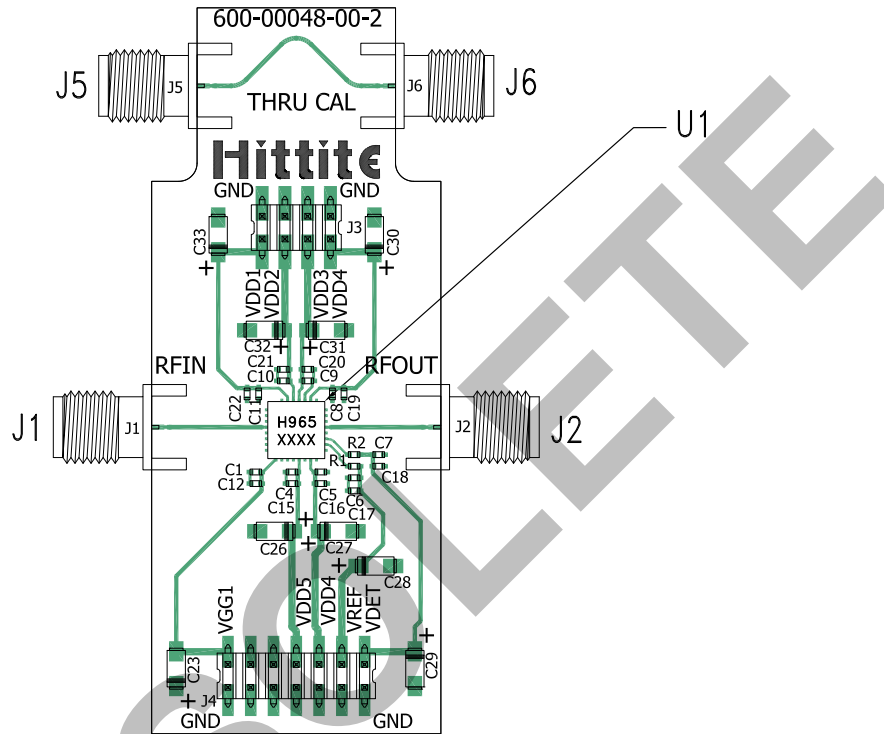

List of Materials for Evaluation PCB EVAL01-HMC965LP5E [1]

Item	Description
J1, J2, J5, J6	K Connector, SRI
J3, J4	DC Pin
C1, C5 - C11	100 pF Capacitor, 0402 Pkg.
C12, C16 - C27	10 nF Capacitor, 0402 Pkg.
C23, C27 - C33	4.7 μF Capacitor, Case A.
U1	HMC965LP5E Power Amplifier
PCB [2]	600-00048-00 Evaluation PCB

[1] Reference this number when ordering complete evaluation PCB

[2] Circuit Board Material: Rogers 4350 or Arlon FR4

The circuit board used in the application should use RF circuit design techniques. Signal lines should have 50 Ohm impedance while the package ground leads and exposed paddle should be connected directly to the ground plane similar to that shown. A sufficient number of via holes should be used to connect the top and bottom ground planes. The evaluation board should be mounted to an appropriate heat sink. The evaluation circuit board shown is available from Hittite upon request.