



Joulescope™ JS110 User's Guide

Precision DC Energy Analyzer

Revision 1.0

Last revised 2020 June 27

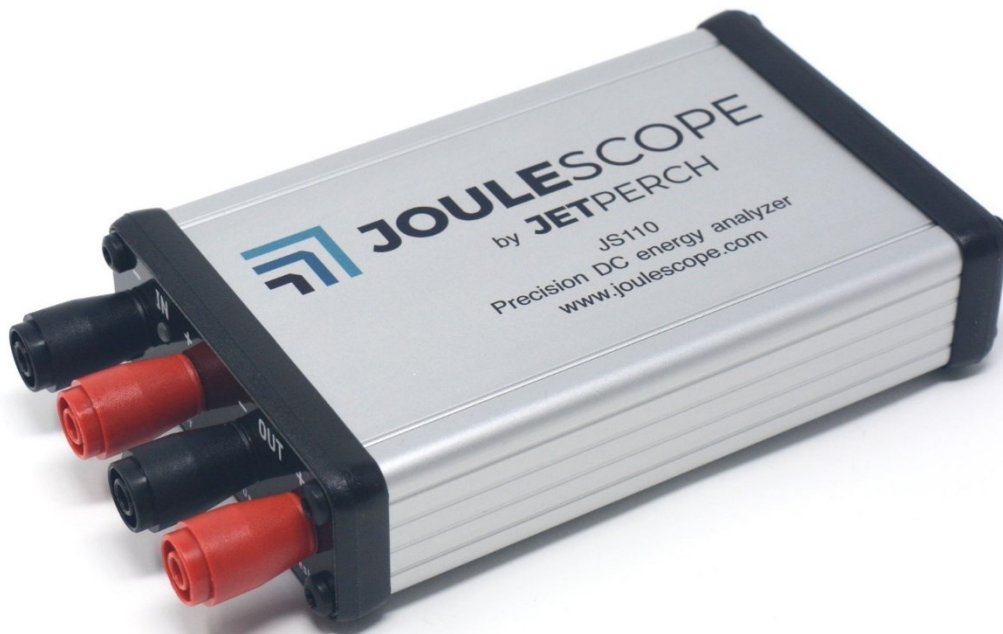

1. Affordable, easy-to-use, accurate and precise

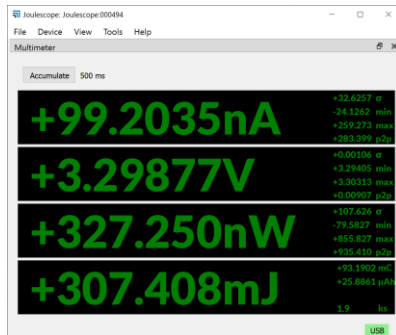

Multimeter view

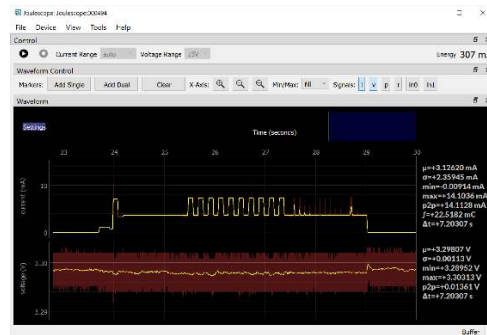

Oscilloscope view

Applications include:

- Microprocessor and microcontroller power profiling and optimization
- Hardware power optimization
- Sleep current optimization
- Hardware and software troubleshooting
- Software characterization and interrupt service routine profiling
- USB 2.0 inrush and suspend current pre-compliance testing
- General-purpose current, voltage, power, charge, and energy measurement

The Joulescope™ JS110 is the most affordable and easy-to-use precision DC energy analyzer. It measures current and voltage, then computes power and energy. Many modern battery-powered devices and IoT devices have a high dynamic current range, which makes accurate measurement difficult. When “sleeping” the devices consume nanoamps (nA) or microamps (μA), but when active, they consume milliamps (mA) or amps (A). Joulescope combines high-speed sampling and rapid dynamic current range switching to provide accurate and seamless current and energy measurements, even for devices with rapidly varying current consumption. The unprecedented accuracy and low-cost of Joulescope allows every engineer on the team to measure the energy consumed by the target device during development. Joulescope provides rapid feedback on how changes affect the overall product battery life.

Joulescope displays instantaneous voltage, current, power, and energy, like a multimeter. The multimeter provides a quick and easy summary of the present state of your device.

Joulescope displays waveforms of voltage and current over time, like an oscilloscope. This oscilloscope view allows you to identify and to troubleshoot dynamic behavior and short events, including inrush current, event handlers, and tasks.

2. Key benefits

- **Dynamic range:** Joulescope accurately measures electrical current over nine orders of magnitude from amps down to nanoamps. This wide range allows accurate and precise current measurements for modern devices. Sleep modes are often just nanoamps (nA) or microamps (μ A). Active modes are often milliamps (mA) or amps (A).
- **Low voltage drop:** Most multimeters and current meters have a significant voltage drop (sometimes called burden voltage or insertion loss), which affects the actual voltage delivered to the device under test. Joulescope has a total voltage drop of 25 mV at 1 A, which keeps your target device running correctly. Joulescope's extremely fast current range switching maintains low voltage drop even under rapidly varying current demands.
- **Makes the invisible visible:** Joulescopes measure current and voltage 2 million times per second with 250 kHz bandwidth. This high sampling rate makes the power consumption of interrupt service routines, inrush currents, and other short events visible.
- **Easy to use:** Joulescope reports cumulative energy consumption along with real-time current, voltage, and power. The multimeter view clearly shows the most recent value, while the oscilloscope view allows you to explore changes over time. Much simpler and more accurate than anything in its class!
- **Customizable:** The Joulescope host software is open source on GitHub. You can also swap the banana jack front panel with front panels that have other connector types. The front panels are open source on GitHub.
- **Portable:** Joulescope fits in your backpack and only needs a small part of your desk. Take Joulescope wherever you want to use it!
- **Affordable:** Joulescope is affordable and priced so that every developer on the team can have one at their desk. With such convenient access, Joulescope allows developers to see the impact of their changes on energy consumption immediately. Developers can make informed choices to account for battery life during design. Eliminate power consumption surprises during final product testing!

3. Key features

- -1V to 15V voltage range
- -1A to 3A current range, continuous
- Up to 10A current pulses (<10 ms, < 3A average per second)
- Down to 1.5 nA resolution, equivalent to 32-bits of dynamic range
- Synchronously measures voltage and current at 2 million samples per second, 14-bit
- 250 kHz bandwidth
- Rapid 1 μ s switching between shunt resistors for seamless dynamic current measurement
- Computes power, total energy, and charge
- Operates with minimal voltage disturbance between IN and OUT ports
- Up to ± 48 V common-mode voltage between USB ground and IN-, IN+, OUT+, and OUT-
- 2 general-purpose inputs and 2 general-purpose outputs
- Programmable on/off for power cycling the target device and measuring inrush currents
- USB 2.0 high-speed host connectivity
- Host software support for Microsoft® Windows®, Apple® Mac® OS X®, and Linux®
- Host software provides real-time graphs of current, voltage, and power over time
- Host software is open source and available on GitHub
- Swappable front panel with open-source designs on GitHub
- Firmware upgradable

See Section 8 for the full specifications.

4. Table of contents

1. Affordable, easy-to-use, accurate and precise	2
2. Key benefits.....	3
3. Key features	4
4. Table of contents	5
5. What comes in the box	7
6. Meet Your Joulescope.....	8
7. Quick start.....	9
8. Specifications	11
8.1. Absolute maximum ratings	11
8.2. Mechanical.....	11
8.3. Recommended operating conditions.....	11
8.4. Specification conditions	11
8.5. Current measurement specifications.....	12
8.6. Voltage measurement specifications.....	12
8.7. General specifications.....	12
8.8. Parasitic effects specifications	12
8.9. Software-controlled fuse specifications	12
8.10. General Purpose Inputs & Outputs.....	13
9. Host software.....	14
9.1. Installation	14
9.1.1. Linux.....	14
9.1.2. Windows 7	14
9.1.3. macOS	14
9.2. Multimeter view	15
9.3. Oscilloscope view.....	16
9.4. Energy and Charge	19
9.5. Open-source.....	19
10. Theory of operation	21
10.1. Ammeter	21
10.2. Voltmeter	22
10.3. Host Computer.....	22
10.4. Power, Energy, Charge, and Statistics.....	22

10.5.	High impedance / low leakage.....	23
10.6.	Electrical isolation	23
11.	How to swap the front panel	24
12.	GPI & GPO	25
13.	Electrical Isolation	27
14.	Typical Behavior	28
14.1.	Step Response.....	28
15.	Compliance	31
15.1.	United States.....	31
15.1.1.	FCC Notice	31
15.2.	Europe.....	31
15.3.	Safety	31
15.4.	RoHS Directive 2011/65/EU, 2015/863/EU	31
15.5.	Country of origin	32
16.	Maintenance	33
16.1.	Verification Procedure	33
16.1.1.	Preliminary operations.....	33
16.1.2.	Voltage Validation Process.....	33
16.1.3.	Current Validation Process.....	34
17.	Warranty	37
18.	Contact.....	38
19.	Glossary.....	39
20.	User's guide information	41
20.1.	Copyright notice.....	41
20.2.	Publisher	41
20.3.	Warranty	41
20.4.	Change log.....	42

5. What comes in the box

Your Joulescope JS110 purchase includes:

- Joulescope JS110 instrument
- Banana Jack Front Panel, already installed
- 6' USB 2.0 A to B cable
- T15 Torx screwdriver
- Quick Start Guide
- Joulescope sticker

You will need to provide:

- A host computer which must be running Microsoft® Windows® 10, Window 7, Apple® Mac® OS/X® or Linux®. Most computers manufactured within the last five years should work. The computer requires an available USB 2.0 port, at least 500 MB of hard drive / solid state drive storage space, and 1 GB of available RAM.
- Suitable cable(s) to connect Joulescope to your power source
- Suitable cable(s) to connect Joulescope to your target device.

You need an internet connection to download the free software.

6. Meet Your Joulescope

The front side of Joulescope has the connectors that connected to your target device and its regular power supply. Connect your power supply positive output to IN+, and connect OUT+ to your target device's positive voltage input. Connect the target device's ground or negative voltage input to OUT-. Connect IN- to your power supply ground or negative output.



The LED indicates when your Joulescope is ready to collect measurements.

The backside of Joulescope has the host USB connector, status LED, and GPIO connector:



Use the provided USB cable to connect the USB host computer connector to your host computer. The status LED indicates when the Joulescope successfully communicates with the host computer. For Windows hosts, the Status LED illuminates shortly after connecting the Joulescope to the computer. For Linux and macOS hosts, the Status LED will not illuminate until the Joulescope software attempts to connect.

The GPIO connector provides two general-purpose inputs and two general-purpose outputs. See Section 12 for details.

7. Quick start

Download the host software from <http://www.joulescope.com/download>. Follow the instructions on the download page to install the software for your platform. Linux, macOS, and Windows 7 may require additional steps. See section 9.1 for details.

Start the Joulescope host software.



Connect the Joulescope USB port to the host computer using the provided USB cable.



The host software will automatically detect the connected Joulescope and start displaying data.

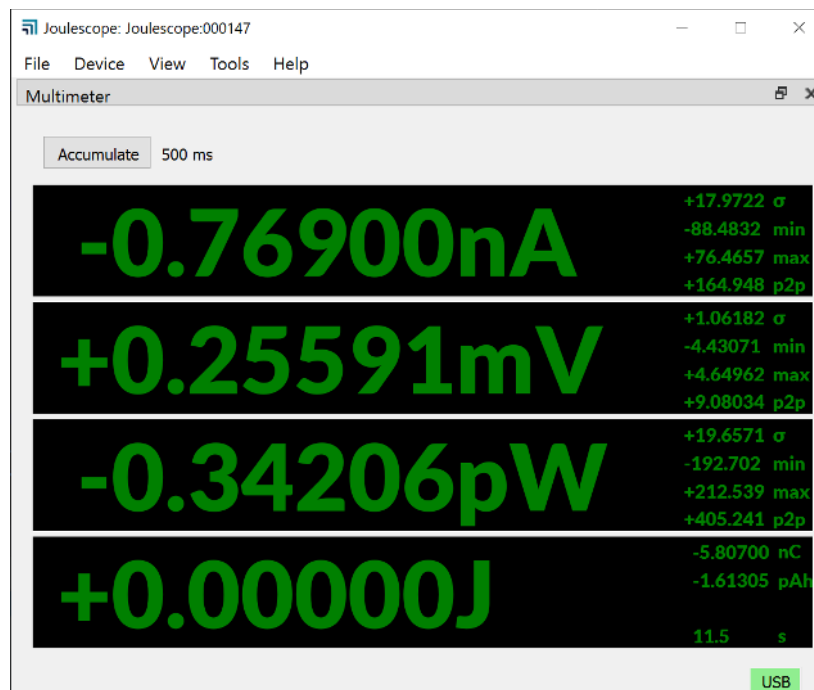

Connect the Joulescope **IN** port to your power source. If using a configurable power supply, set the voltage and current suitable for your device under test. The maximum voltage between **IN+** and **IN-** should never exceed $\pm 15V$. **IN** and **OUT** are electrically isolated from USB, but the voltage between any port and USB ground should never exceed $\pm 48V$.



Connect the Joulescope “OUT” port to the power input for your device under test.



Operate your device under test. The Joulescope host software starts in the **Multimeter** view by default. Use the **Multimeter** view to measure the current, voltage, power, charge, and energy consumption.

Dive into more detail with the oscilloscope view. Select **View** → **Oscilloscope Default** to display waveforms of voltage, current, and power over time.

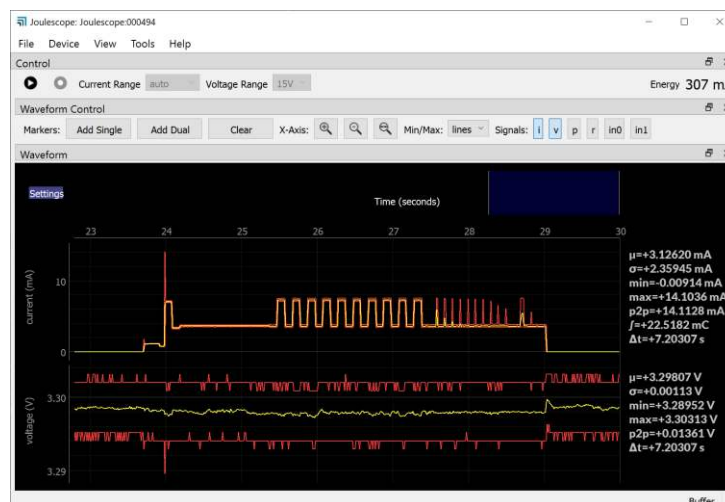

8. Specifications

8.1. Absolute maximum ratings

	Min	Max	Unit
USB voltage	-0.3	6	V
Max voltage applied between IN+ to IN-	-20	20	V
Max voltage applied between OUT+ to OUT-	-20	20	V
Max voltage to USB ground (IN+, IN-, OUT+, OUT-)	-48	48	V
Input current (powered, burst)	-10	10	A
Input current (powered, sustained)	-3	3	A
Input current (unpowered)	-0.5	N/A (off)	A
Storage temperature	-40	80	°C
Operating temperature	0	50	°C
Relative humidity (non-condensing)	0	95	%
Altitude from sea level	-100	2500	m
Max voltage applied to GPI relative to USB ground	-10	10	V

8.2. Mechanical

	Typical	Unit
Weight	217	grams
Width	81	mm
Length (including banana jack front panel)	150	mm
Height	33	mm

8.3. Recommended operating conditions

	Test condition	Min	Typical	Max	Unit
Operating temperature		10		40	°C
USB supply voltage		4.5	5.0	5.5	V
USB supply current				500	mA
Voltage applied to IN		-1.0		15	V
Input current	continuous	-1.5		3	A
Input current pulse	< 10 milliseconds, < 3A average			10*	A
Input current pulse	< 100 milliseconds < 3A average			5*	A

* Suitable for handling inrush currents when connecting capacitive loads.

8.4. Specification conditions

Temperature	23 °C ± 10 °C
Humidity	20% to 80% RH, non-condensing
Calibration interval	1 year*

* Recommended to comply with industry-standard practices, but Joulescope is designed not to need recalibration.

8.5. Current measurement specifications

Range	Accuracy	Resolution	Impedance	Bandwidth
10 A*	±0.3% ±7 mA	1 mA	0.01 Ω	250 kHz
2 A	±0.3% ±1.50 mA	175 μA	0.01 Ω	250 kHz
180 mA	±0.3% ±150 μA	15 μA	0.11 Ω	250 kHz
18 mA	±0.25% ±15 μA	1.5 μA	1.11 Ω	250 kHz
1.8 mA	±0.25% ±1.5 μA	150 nA	11.1 Ω	180 kHz
180 μA	±0.25% ±150 nA	15 nA	111 Ω	70 kHz
18 μA	±0.25% ±30 nA	1.5 nA	1111 Ω	15 kHz

* Joulescope is designed for 3 A sustained. See the recommended operating conditions for maximum durations for higher currents.

Test current measurement bandwidth by varying the effective load impedance. Due to load capacitance, altering the source voltage is not a valid method of testing current bandwidth.

8.6. Voltage measurement specifications

Range	Accuracy	Resolution	Impedance	Bandwidth
15 V	±0.1% ±11 mV	1.2 mV	-	250 kHz
5V	±0.1% ±3.5 mV	400 μV	-	250 kHz

8.7. General specifications

	Test condition	Min	Typical	Max	Unit
Sampling frequency	25 °C		2000000		sps
Sampling frequency	25 °C	-20		20	ppm
Front panel insertions				100	

8.8. Parasitic effects specifications

	Test condition	Min	Typical	Max	Unit
Current leakage (IN+ to IN-)	25 °C, +3.3V		2		nA
Current leakage (IN+ to IN-)	25 °C, +5V		2		nA
Current leakage (IN+ to IN-)	25 °C, +15V		3		nA
Shunt resistor voltage, max	0 to 2 A, static		20	21	mV
Burden voltage (IN+ to OUT+)	< 1 A, banana jacks	0	25	30	mV
Burden voltage (OUT- to IN-)	< 1 A, banana jacks	0	3	8	mV
Shunt switching time	Over-range < 100 ns rise time	0	0.8	1.2	μs
Over-range settling time		0	2	5	μs
Under-range settling time		0	2	5	μs

8.9. Software-controlled fuse specifications

	Test condition	Min	Typical	Max	Unit
Current leakage (IN+ to OUT+)	25 °C, 3.3V		5		nA
Current leakage (IN+ to OUT+)	25 °C, 5V		7		nA
Current leakage (IN+ to OUT+)	25 °C, 15V		28	5000	nA

8.10. General Purpose Inputs & Outputs

	Test condition	Min	Typical	Max	Unit
Programmable logic level voltage		1.8		VUSB - 0.2	V
Input leakage per pin	25 °C			±1	µA
Input leakage per pin				±2	µA
Output voltage high	-100 µA	Vcco-0.1			V
Output voltage high	-4 mA @ 1.65 V	1.2			V
Output voltage high	-8 mA @ 1.65 V	1.9			V
Output voltage high	-24 mA @ 1.65 V	2.4			V
Output voltage high	-32 mA @ 1.65 V	3.8			V
Output voltage low	100 µA			0.1	V
Output voltage low	4 mA @ 1.65 V			0.45	V
Output voltage low	8 mA @ 2.3 V			0.3	V
Output voltage low	24 mA @ 3 V			0.55	V
Output voltage low	32 mA @ 4.5 V			0.55	V
Output impedance	10 mA	90	100	110	Ω
GPI sample rate			2		MSPS
Continuous output current	Per pin			±50	mA
Total power dissipation	Over output impedance			0.25	W

The Joulescope uses the TI SN74LVC2T45 for both the GPIs and GPOs. See the [SN74LVC2T45 datasheet](#) for more information. Both the GPIs and GPOs are protected with the [Vishay VEMI45AA-HNH](#), which is an EMI filter with ESD protection. The VEMI45AA is a pi filter with 100 Ohm resistance and capacitance between 29 pF and 60 pF.

GPIO Supply

	Min	Typical	Max	Unit
+5V output	4.4V	VBUS – 0.1	5.5	V
Current			100	mA
Output impedance		1		Ω

9. Host software

The Joulescope host software runs on a host computer and communicates with the Joulescope instrument over USB 2.0 high-speed.

The software works with Microsoft® Windows® 10, Windows® 7, Apple® Mac® OS/X®, and Linux®. For Linux, only Ubuntu 18.04.1 LTS is tested. The Joulescope software only supports 64-bit operating systems with 64-bit python 3.6+.

9.1. Installation

The Joulescope software is available to download at

www.joulescope.com/download/

Click on the download link for your platform. For a list of all releases for all platforms, see

https://download.joulescope.com/joulescope_install/index.html

Follow the usual process to download and install the software following the on-screen directions. Several operating systems may require additional steps, as noted below.

We recommend installing the Joulescope software on the native operating system, not under a virtual machine, due to Joulescope's demanding USB communication requirements.

9.1.1. Linux

Many Linux systems, including Ubuntu, use “udev” to manage devices and grant permissions. You will need to install a udev rule that grants Joulescope hardware access to your account. Download and follow the instructions in this file:

<https://raw.githubusercontent.com/jetperch/pyjoulescope/master/99-joulescope.rules>

9.1.2. Windows 7

Windows 10 and many Windows 7 machines will run without additional steps. However, some Windows 7 machines do not include Microsoft's WinUSB, the driver used by Joulescopes. You will need to install the driver manually.

1. Download <https://raw.githubusercontent.com/jetperch/pyjoulescope/develop/joulescope.inf>
2. In the Windows → Run bar, type **devmgmt.msc**
3. Right-click on Joulescope, select “Update Driver Software...”
4. Select “Browse my computer for driver software”
5. Browse to the directory where you downloaded the joulescope.inf file
6. The driver should install, and your Joulescope should no longer have a yellow exclamation mark

9.1.3. macOS

The macOS distribution is currently signed, but it is not distributed through the Apple Store. Newer versions of macOS, such as Catalina, indicate security warnings. You may need to control-click the Joulescope application, then select “open” to bypass these security warnings. You will need to repeat the control-click, “open” process several times (usually twice) until macOS finally allows the Joulescope software to launch. After granting this permission once, subsequent runs will run normally.

9.2. Multimeter view

Upon launching the host software, you see the multimeter view:

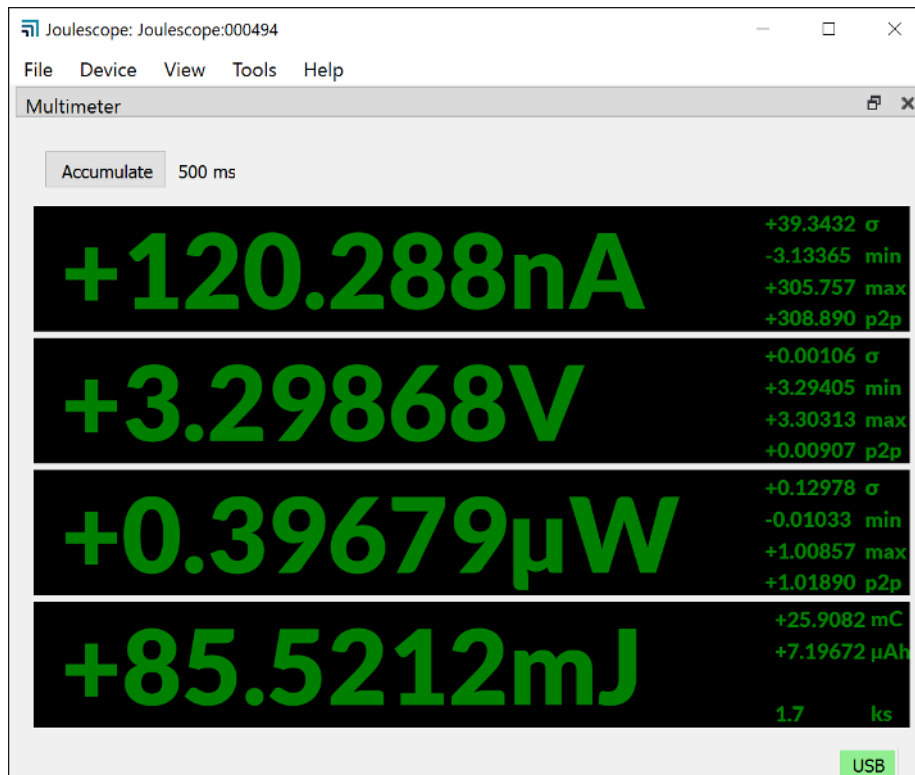

You can return to this view at any time using **View** → **Multimeter**.

The multimeter view provides the present operating state at a glance. The multimeter view displays several quantities:

- Electrical current in amperes (A)
- Electrical voltage in volts (V)
- Power in watts (W)
- Energy in joules (J)
- Charge in either coulombs (C) or amp-hours (Ah).

This display, along with all other value displays in the Joulescope software, the SI standard prefixes for orders of magnitude:

Prefix	Power	Name
G	10^9	giga-
M	10^6	mega-
k	10^3	kilo-
m	10^{-3}	milli-
μ	10^{-6}	micro-
n	10^{-9}	nano-
p	10^{-12}	pico-

The multimeter view updates every half second (0.5 seconds) by default. The software computes and displays the statistics over each half-second time window. The large numbers are the mean (also called average) value of that quantity over the window. The software also displays:

- σ : The standard deviation
- min: The minimum value
- max: The maximum value
- p2p: The peak-to-peak value, which is equal to (max – min)



Note that energy does not display these additional statistics since they are not meaningful.

Every update represents only the data recorded over the last half-second. If you click on the “Accumulate” button to activate it, then the software extends the statistics to combine each new half-second window without discarding results from previous windows.

9.3. Oscilloscope view

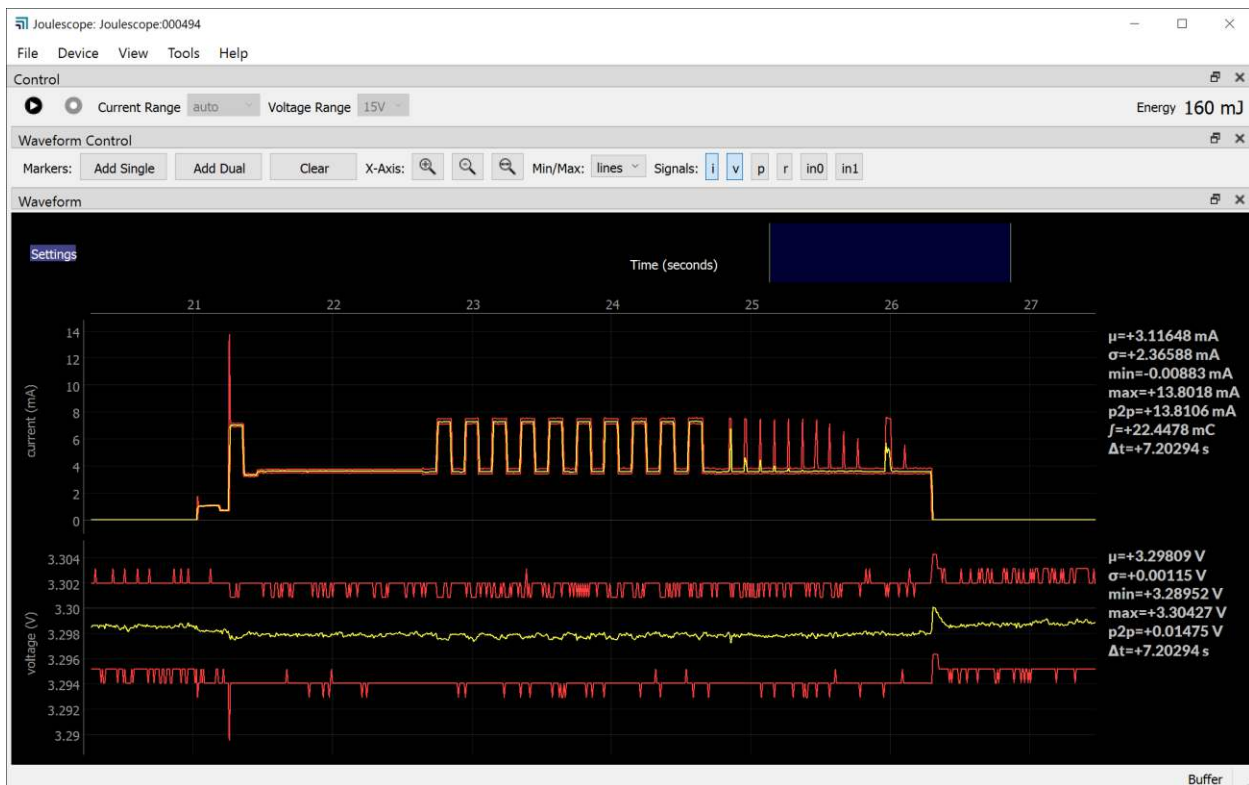
The software includes an oscilloscope view. Click **View** → **Oscilloscope**.



The first view allows you to control the connected Joulescope. Press  to pause or resume capturing live data. Press  to start and stop recording data to a file. This feature is only available when the device is capturing live data.

Current Range allows you to select Joulescope’s active shunt resistor. Most applications use **auto**, where Joulescope automatically selects the best range. However, you can manually force the range. Select **off** to disconnect power to the target device.

Voltage Range allows you to select the voltage range. Joulescope includes a **15V** range and a more sensitive **5V** range.

The Control widget in the Oscilloscope view also displays the energy or current consumed. Left-click or select **Tools** → **Clear Accumulators** to reset the accumulators to zero. Right-click or use **File** → **Preferences** → **Units** → **Accumulator** to set the displayed field to either energy or current.

The software displays two different waveforms by default. The top waveform is electrical current, and the bottom waveform is electrical voltage. The x-axis is time. If you have a Joulescope connected, it will automatically add the most recent data to the right of the waveform and shift existing data to the left. The y-axis data is the value measured at the corresponding point in time. Joulescope captures data 2 million times per second. When zoomed out, each x-axis pixel may represent many, many samples, which are that pixel's sample window. The plot displays the statistics over each pixel. The yellow line is the mean (average). The red lines are the minimum and maximum. Power glitches, such as interrupt service routines, are very interesting for energy optimization. The minimum and maximum ensure that you do not miss these events, even when zoomed out. When you eventually zoom in far enough, the red lines disappear because 1 pixel becomes 1 sample, and the minimum and the maximum are the same as the average. You can use **File** → **Preferences** → **Waveform** → **show_min_max** to disable these lines or display the minimum to maximum region as a fill instead.

The software computes statistics quantities over the full-time window shown in the present view for each waveform. The software displays the statistics on the right edge of the window. The statistical quantities are:

- μ : The mean (also called average) value
- σ : The standard deviation
- p2p: The peak-to-peak value (max - min)
- min: The minimum value
- max: The maximum value
- \int : The integral over the time window

The waveform view supports **Annotations** to present additional information, which includes:

- A **Single Marker** that display information at a single point. Names used by other equipment for this feature include marker and cursor.
- **Dual Markers** that display information over a time window. Names used by other equipment for this feature include cursors, timing markers, window, and range selection.

To display statistics at a single point, move the mouse to the x-axis time labels near the top. Then right-click (control-click on Mac OS) to bring up the context menu. Select **Annotations** → **Single Marker**.

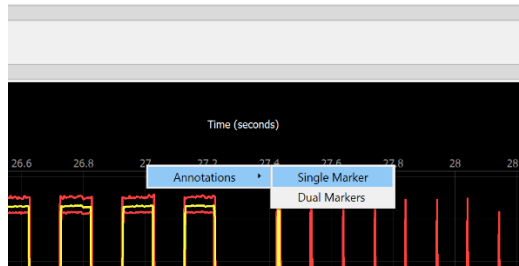

Left-click the marker to move it with the mouse. As you move the mouse over the waveforms, the vertical marker follows along. The line displays statistics about that location:

- t : The sample time for the displayed sample or window
- μ : The mean (also called average) value

When the location contains more than one sample per displayed pixel, the line displays statistics over that single pixel's sample window:

- σ : The standard deviation
- p2p: The peak-to-peak value (max - min)
- min: The minimum value
- max: The maximum value

Left-click again to keep the marker in position.

To display statistics over a selectable range, right-click on the x-axis time labels and select **Annotations** → **Dual Markers**. Left-click a marker to move it with the mouse, then left-click again to stop moving the marker. Hold the **Ctrl** key while left-clicking to move both markers together. Right-click (control-click on Mac OS) on one of the dual markers to export data or perform analysis over the selected range.

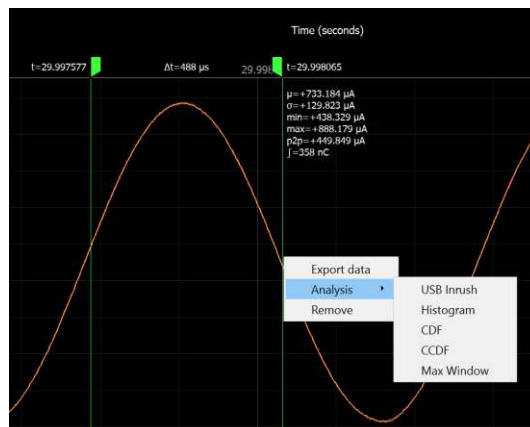

Use the scroll wheel to zoom in and zoom out. The zoom operation keeps the point under the mouse cursor at the same location after the zoom operation. However, when you reach the maximum extents while zooming out, that point may move. When viewing live data, the zoom operation always keeps the most recent data in view at the right.

Press the left mouse button and drag the cursor left or right to pan in time. Pan is not supported when viewing live data from a Joulescope.

The software displays the waveform on a linear scale with automatic y-axis ranging by default. The y-axis context menu has additional options. Right-click (control-click on Mac OS) on the y-axis to display the menu.

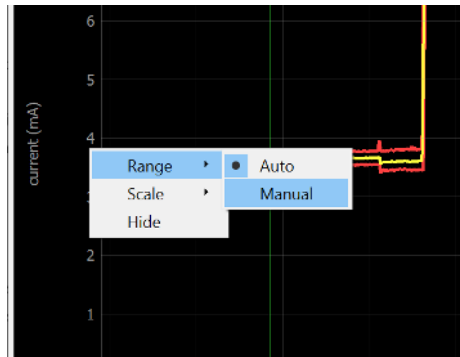

When manual ranging is activated, hover over the y-axis and use the scroll wheel to zoom in and out. Left-click and drag up and down to pan the y-axis.

Use the y-axis context menu to change the y-axis scale mode. The y-axis displays in linear coordinates by default but also supports a logarithmic scale. A logarithmic scale is handy to view wide dynamic ranges for current and power.

Use the y-axis context menu to hide the signal. Click **Settings** at the top left to display the settings menu. Select **Add** → **[Signal Name]** to display a signal not already shown.

9.4. Energy and Charge

The Joulescope measures current and voltage two million times per second. It then multiplies current by voltage to compute power. Joulescope then integrates power over time to compute energy. It also integrates current to compute charge. Joulescope displays energy in both the Multimeter view and Oscilloscope view. This value starts accumulating when the software starts. Use **Tools** → **Clear Energy** to reset it to zero at any time.

The energy value and charge value provide a simple measurement to observe changes, especially for software. You can baseline the performance of an operation by recording the measured energy or charge value. You can then make changes, repeat the test, and observe the new energy or charge value. The oscilloscope view enables you to investigate in further detail.

9.5. Open-source

The host software is open source and written in Python 3.6+. The host software consists of two layers:

Repo name	Python package name	Description
pyjoulescope_ui	joulescope_ui	The Joulescope User Interface written in QT/PySide2
pyjoulescope	joulescope	The Joulescope “driver” which enables scripting

The joulescope package was designed so that you can script custom Joulescope actions and integrate Joulescope into your applications.

See the GitHub repositories for the latest details.

https://github.com/jetperch/pyjoulescope_ui

<https://github.com/jetperch/pyjoulescope>

You can find examples for how to use Joulescope in your Python application at:

https://github.com/jetperch/pyjoulescope_examples

Also see the documentation:

<https://joulescope.readthedocs.io/>

The Joulescope software depends upon other software and libraries. See CREDITS.html for [pyjoulescope_ui](#) and [pyjoulescope](#).

10. Theory of operation

Joulescope simultaneously measures current and voltage, and then computes power and energy. Joulescope combines a voltmeter and a fast auto-range current shunt ammeter.

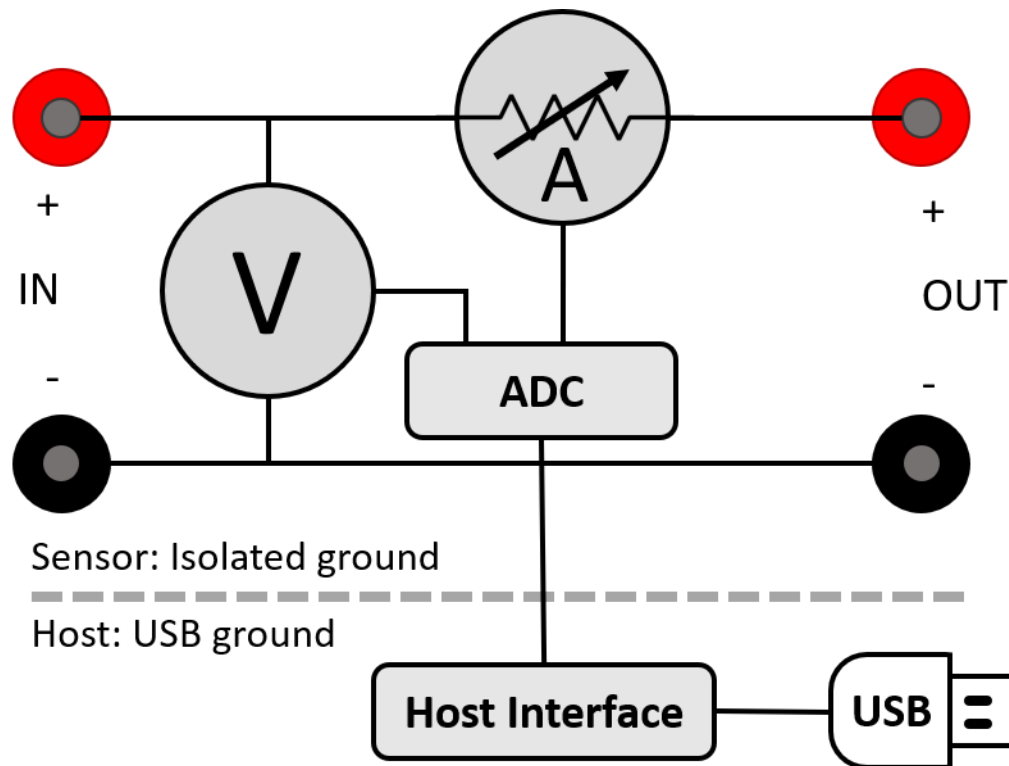

10.1. Ammeter

The shunt ammeter consists of seven (7) current ranges with six (6) different shunt resistor values ranging from 0.01Ω to 1111Ω . Joulescope actively selects the best shunt resistor to keep the maximum voltage across the shunt resistor to 20 mV. This low voltage drop minimizes the impact on the device under test. Other equipment, including standard multimeters, have a much larger burden voltage that can cause the target device to behave unusually.

The Joulescope amplifies the voltage across the shunt resistor and then uses an analog-to-digital converter (ADC) to digitize the value. The ADC digitizes the value 2 million times per second to create 2 million samples per second (SPS). The Joulescope instrument sends these ADC values to the host software over USB. Given a known resistor value and the measured voltage, the Joulescope uses Ohm's Law to compute current. Each Joulescope contains a calibration. The software applies the calibration to convert the ADCs into measured current values. Joulescopes are individually calibrated and tested in the factory to ensure that every Joulescope performs to specification.

As the current changes, the ammeter selects the optimal shunt resistor value. Joulescope uses dedicated hardware to quickly select the appropriate shunt resistor to avoid impacting the device under test. The shunt value selection uses the ADC output, dedicated over-range analog hardware, and a unique algorithm that runs in an FPGA. The FPGA selects the active shunt resistors using MOSFETs, which were carefully qualified to meet Joulescope's demanding performance characteristics.

The shunt resistor selection does take some time. How fast does the shunt resistor need to change to have a minimal impact? The linearized equation is:

$$t = C * \Delta V / \Delta I$$

Let's take a typical example. The target device takes 3.3V and can tolerate a temporary 3% (0.03) voltage glitch on a 1 amp change. If the target device has 10 μ F of capacitance, the required shunt resistor switching time is approximately:

$$10 \mu\text{F} * 3.3 \text{ V} * 0.03 / 1 \text{ A} = 1 \mu\text{s}$$

Joulescope was designed to achieve 1 μ s switching speed to meet this demanding case. Most target systems have larger capacitance and less dramatic step current changes. In all cases, the shunt resistor selection is always make-before-break to ensure uninterrupted connectivity to the target device.

10.2. Voltmeter

The voltmeter measures the voltage between IN+ and IN-. The voltmeter scales the input voltage, and uses an analog-to-digital converter (ADC) to digitize the value. The Joulescope instrument sends the voltage samples, along with the current samples, to the host computer. The software applies the calibration to convert from ADC values to actual voltage.

The voltmeter has two different ranges, and you can manually select the best range for your application. The 5V range provides higher resolution for smaller voltages, while the 15V range allows for larger voltage measurements.

10.3. Host Computer

The Joulescope instrument requires a host computer to operate. The Joulescope instrument sends 2 million current and voltage samples per second immediately to the host computer over USB. Unlike traditional oscilloscopes, a Joulescope is always capturing data. The terms "trigger" and "sample buffer" do not fully apply to the Joulescope device, since all sample data arrives at the host computer. The Joulescope User Interface (UI) temporarily stores capture data in a circular buffer. The UI allows you to adjust the buffer size to use your host computer's RAM. Joulescope can also record to a file, and the capture size is only limited by your computer's available storage on your hard disk drive or solid-state drive.

The Joulescope host software is open-source. The pyjoulescope "driver" communicates with the appropriate operating system USB driver. Joulescopes use Microsoft's WinUSB on Windows, which is included by default with the Windows operating system. On Linux and macOS, Joulescope uses the popular, open-source libusb driver. The pyjoulescope driver provides an easy-to-use scripting environment. You can also use the driver to build integrated applications, such as the Joulescope UI, that use the Joulescope instrument data.

10.4. Power, Energy, Charge, and Statistics

Joulescopes only measure current and voltage. The Joulescope software uses math to compute the power, energy, and charge. Power is the current multiplied by the voltage:

$$P = V * I = V^2 / R = I^2 * R$$

Energy is the integral of power over time.

$$E = \int P dt$$

When we talk about energy, we often mean the energy consumed over a specific time interval, which is the definite integral:

$$E = \int_{t=0}^T P dt \approx \sum_{n=0}^N P_n \Delta t$$

The Joulescope host software performs the discrete-time Euler integration shown to the right. The Joulescope software carefully manages the numerical precision to ensure that it computes energy correctly. IEEE double-precision floating-point numbers do not provide sufficient precision.

Charge is the integral of current over time.

$$C = \int_{t=0}^T I dt \approx \sum_{n=0}^N I_n \Delta t$$

Charge and energy are mathematically similar. Both voltage and current contribute to energy, but only current contributes to charge.

10.5. High impedance / low leakage

Joulescope measures currents at nanoamp resolutions and accuracies. Many contemporary devices have input impedances of 1 M Ω to 10 M Ω , which is not good enough. At 3.3V, a 10 M Ω load draws:

$$3.3V / 10 M\Omega = 330 \text{ nA}$$

Joulescope features a combined input impedance and leakage current of approximately 1 G Ω . This high input impedance allows Joulescope to make accurate and precise low current measurements.

10.6. Electrical isolation

The sensor side of Joulescope is electrically isolated from the host computer. This isolation allows you to insert Joulescope into your test system without worrying about ground issues, including ground loops and ground noise.

11. How to swap the front panel

Joulescope comes standard with a banana jack front panel. However, Joulescope is designed to be flexible and can support other connector types.



The front panel design is open source, and available on GitHub:

https://github.com/jetperch/joulescope_front_panels

To swap the front panel, you will need:

- T15 Torx screwdriver
- The new front panel

Swapping the panel is easy, but you do need to take proper precautions to avoid damaging your Joulescope. Joulescope can be damaged by static electricity that you don't even notice. When you expose the Joulescope main board, be sure only to handle it by the board edges. Follow these steps carefully:

- Completely disconnect the Joulescope, including **IN**, **OUT**, and **USB** ports.
- Use the Torx screwdriver to remove the four screws at the corners of the existing front panel.
- Gently push the Joulescope's USB connector into the Joulescope body. This action will push the front panel out. Expose about ½" or 1 cm.
- Grab the sides of the main board in one hand, being careful not to touch any other part of the board.
- Grab the existing front panel by the sides and carefully pull it directly out.
- Grab the new front panel by the sides, align the pins, and carefully push it in.
- Fully seat the front panel in the black plastic bezel. You may need to gently guide the board to ensure that the USB connector fits in the back panel.
- Use the Torx screwdriver to install the four screws at the corners of the existing front panel.

12. GPI & GPO

The Joulescope contains two (2) general-purpose inputs (GPI) and two (2) general-purpose outputs (GPO), located near the host USB connector.

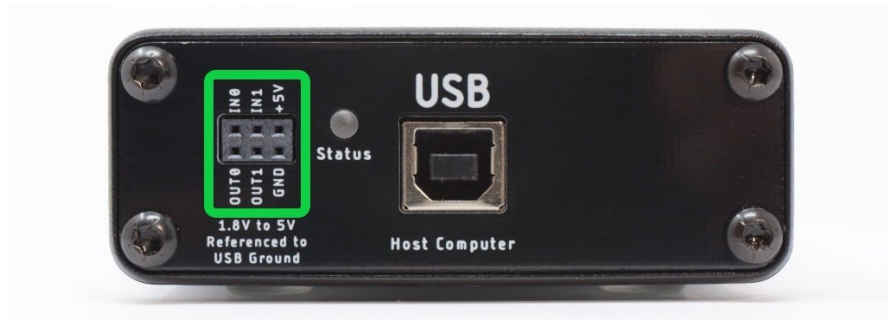

These signals enable time-synchronization with the device under test and other external equipment. The user interface can display GPIs time-synchronized with current, voltage, and power in the oscilloscope view.

One intended application for the GPIs is to allow the target microcontroller firmware to identify areas of interest. The microcontroller can toggle bits so that you can easily see the energy consumption in the marked time windows.

When the GPI feature is activated, the voltage and current samples will only be 13 bits (the GPI will be in the LSB), not the full 14-bits.

Both GPI and GPO are referenced to USB ground. Many applications using Joulescope will want isolated GPI/GPO for improved performance. When selecting an isolation solution, consider:

- Electrical isolation
- Self-powered target interface with very low power from target device – leakage currents only
- Variable voltage technology levels with an external reference voltage
- ESD protection
- Overvoltage protection (GPO)
- Short circuit protection (GPO)
- Very high ($G\Omega$) input impedance (GPI)

To control the GPIO, add the GPIO Widget by selecting **View** → **GPIO**.

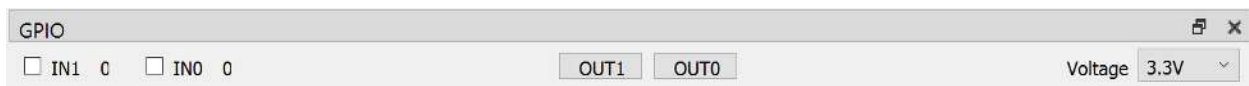

Select the reference voltage for your GPIO, which is configurable from 1.8V to 5.0V. This voltage determines the OUT0 and OUT1 output voltages. The input threshold voltage is one half of this voltage.

Inputs are optional. Check **IN0** to enable the GPIO input. Check **IN1** to enable the GPI1 input. To display either IN0 or IN1, select **Settings** → **Add**, then select either in0 or in1.

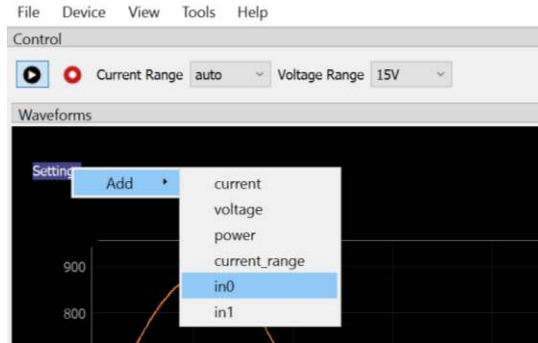

Manually toggle **OUT0** by pressing the OUT0 button. Manually toggle **OUT1** by pressing the OUT1 button.

13. Electrical Isolation

The Joulescope is electrically isolated between the USB interface and the IN/OUT sensor. Joulescope is rated to $\pm 48V$ between USB ground and any of IN+, IN-, OUT+, and OUT-. The individual component ratings far exceed this specification. The components are:

Part #	Mfgr	Description	Isolation working	Isolation 60s	Isolation 1 s
760390014	Würth	Transformer	400 VRMS	2500 VAC	3125 VAC
Si8661BB-B-IS1	Silicon Labs	Digital isolator	445 VRMS		4500 VRMS
TLP2361(TPL,E	Toshiba	Opto isolator	500 VRMS	3750 VRMS	

The printed circuit board (PCB) clearance between the isolated sensor side and the USB host side is 1 mm. The use of an aluminum enclosure effectively limits the isolation voltage and requires that USB chassis ground surrounds the sensor edges. If you use Joulescope in a custom application without the standard enclosure, the four chassis ground rails (2 top & 2 bottom) can be cut around the isolation line to give a 4 mm PCB clearance between the USB host side and the sensor side.

14. Typical Behavior

This section contains information regarding typical Joulescope behavior.

14.1. Step Response

Joulescope is a shunt ammeter with incredibly fast autoranging. This section contains typical autoranging measurements.

The test setup includes a Joulescope, a custom load board, a power supply, a computer, and some cables. A custom load board is the Joulescope target. The load board was specifically designed for the sole purpose of creating very fast, repeatable edges. It has a 1 M Ω resistor in parallel with a 1 Ω resistor. The board contains a momentary pushbutton and debouncer, which is the input to the MCP1416 MOSFET driver. The MCP1416 drives the FDMC7678 MOSFET, which enables or disables the 1 Ω resistor. The entire circuit is powered by a 9V battery and connected to the Joulescope OUT.

The power supply is a Siglent SPD3303X-E bench supply configured for 1.00V and 2.9A. The supply is connected to Joulescope IN. Any bench supply with reasonable transient performance should do.

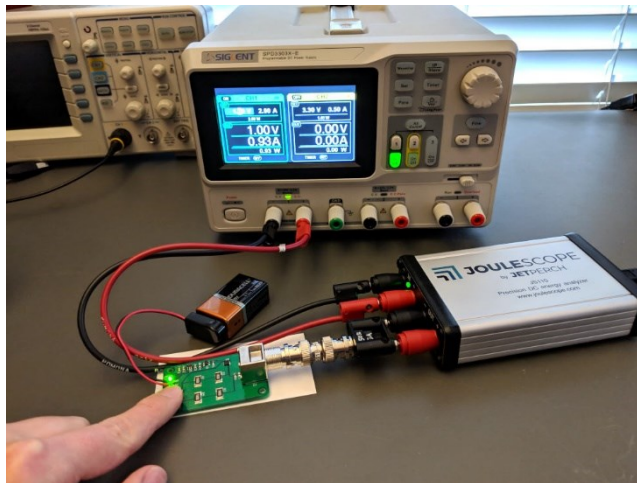

Figure 1: The step response test setup

The normal Joulescope user interface software captures data while pressing the target board's switch to toggle the MOSFET & 1 Ω resistor. A custom Python script reads the data, processes the data, and creates plots. The python script finds each edge and aligns them so that they can be plotted together. The plots show rising edges in the left column and falling edges in the right column.

The first capture "step_2A.png" is the baseline with Joulescope auto-ranging disabled and set to a fixed 2A range. The rise time you see is due to the Joulescope bandwidth. The actual edge is much, much faster.

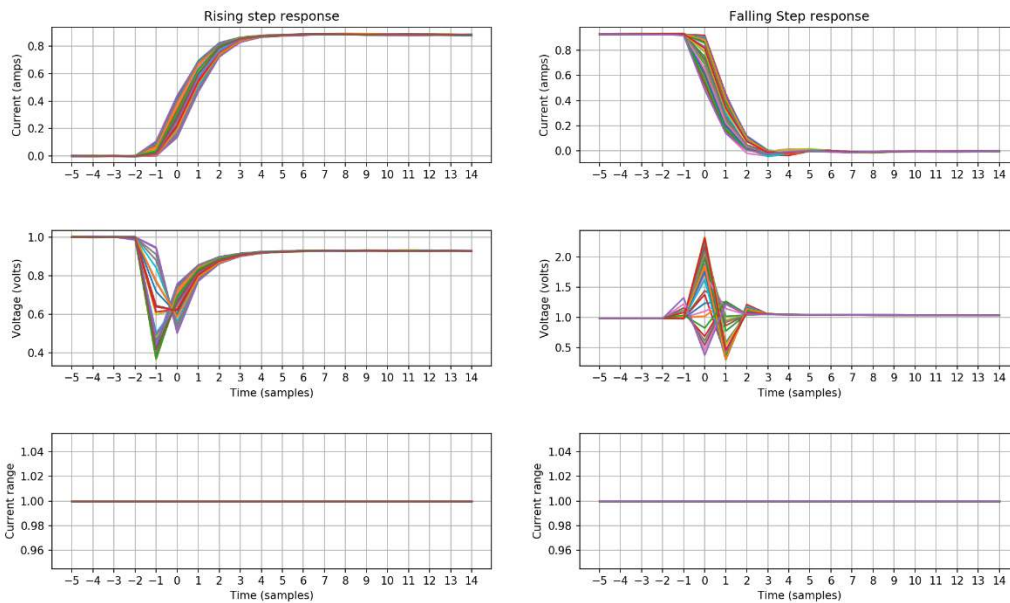

Figure 2: Step response with fixed 2A range

The second capture “step_autorange.png” is with auto-ranging. The two samples after over-range tend to contain “garbage” data that messes up the y-axis range, so they are omitted. These samples are captured at 2 MSPS (500 ns). Joulescope’s stated bandwidth is 250 kHz ($4 \mu\text{s} = 8$ samples).

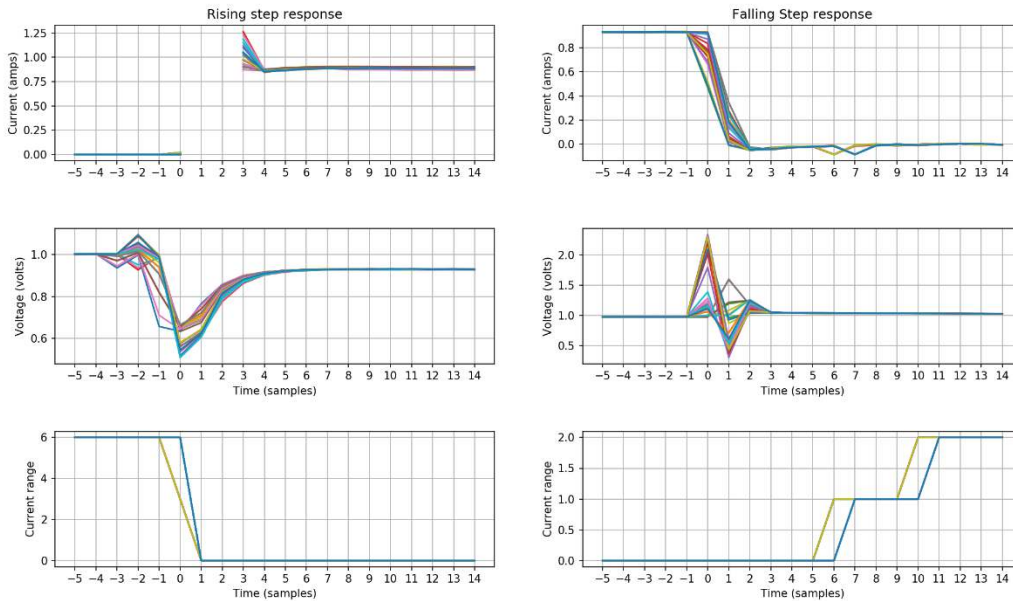

Figure 3: Step response with autoranging

The Joulescope specification states that range switching occurs within 1.2 μs max. This specification determines how much (or in the case of Joulescope, how little) voltage drop happens when the target changes current demands. The Joulescope specification gives over-range settling time is 2 μs typical with 5 μs max. This specification determines how well Joulescope can measure data through the transition. Any auto-ranging ammeter needs to be VERY fast to limit voltage variations at the target device, and Joulescope was designed to meet these demanding requirements.

15. Compliance

For additional compliance information, see

<https://www.joulescope.com/compliance/JS110>

15.1. United States

15.1.1. FCC Notice

This equipment has been tested and found to comply with the limits for a Class A digital device, pursuant to part 15 of the FCC Rules. These limits are designed to provide reasonable protection against harmful interference when the equipment is operated in a commercial environment. This equipment generates, uses, and can radiate radio frequency energy and, if not installed and used in accordance with the instruction manual, may cause harmful interference to radio communications. Operation of this equipment in a residential area is likely to cause harmful interference in which case the user will be required to correct the interference at his own expense.

Operation of this equipment in a residential area is likely to cause harmful interference in which case the user will be required to correct the interference at his own expense.

Changes or modifications not expressly approved by the party responsible for compliance could void the user's authority to operate the equipment.

This device complies with part 15 of the FCC Rules. Operation is subject to the following two conditions: (1) This device may not cause harmful interference, and (2) this device must accept any interference received, including interference that may cause undesired operation.

15.2. Europe

Warning – This is a Class A product. In a domestic environment this product may cause radio interference, in which case the user may be required to take adequate measures.

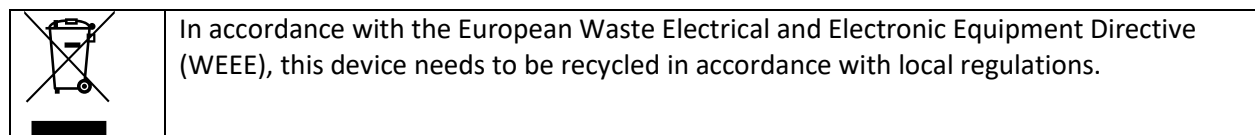

15.3. Safety

Joulescope is an Extra-Low Voltage device as per IEC 60038. Joulescope is intended for INDOOR USE only.

15.4. RoHS Directive 2011/65/EU, 2015/863/EU

This product is CE marked and complies with the European Union's Directive 2011/65/EU OF THE EUROPEAN PARLIAMENT AND OF THE COUNCIL of 8 June 2011 on the restriction of the use of certain hazardous substances in electrical and electronic equipment.

EU Directive 2015/863 of 31 March 2015 amends Annex II to Directive 2011/65/EU of the European Parliament and of the Council as regards the list of restricted substances.

15.5. Country of origin

United States of America

Made in Maryland, USA.

16. Maintenance

Joulescope is designed for minimal maintenance. To clean your Joulescope, disconnect all wires from the unit. You can gently wipe the unit with a damp cloth using water only. Using rubbing alcohol or other cleaning agents may damage your Joulescope. Do not submerge.

Joulescope is factory calibrated and should continue to function within specifications over its operating life. For critical or demanding applications, you may choose to follow industry-standard practices and have your Joulescope recalibrated annually. Tra-Cal, located in Maryland, USA, provides authorized ISO 17025:2017 calibration and recalibration. You can submit your request at:

<https://nscainc.com/calibration-repair-rfq-form/>

Recalibrating Joulescope requires custom equipment and trained personnel. Only Jetperch LLC and Tra-Cal are authorized to perform recalibration.

16.1. Verification Procedure

Calibration should normally find that the Joulescope instrument still operates within specification. Although calibration can only be performed by authorized vendors, any facility capable of performing precision multimeter calibration can verify that a Joulescope is operating within specification. This section describes the verification procedure.

16.1.1. Preliminary operations

1. Download the host computer software from <https://www.joulescope.com/pages/downloads>
2. Install the software
3. Download the validation spreadsheet from <https://download.joulescope.com/docs/validation/index.html>
4. Connect your Joulescope to the host computer using the provided USB cable.
5. Select **View**. If the first **Multimeter** is not already selected, select it.
6. Select **View**. If **Control** is not already selected, select it.
7. Open the validation worksheet in Excel and fill in the Device Under Test Information.
8. Select File → Save As for this device calibration.
9. Optionally configure your Test Uncertainty Ratio (TUR) to your desired level. We recommend following industry-standard practices and set TUR to 4 or greater.

16.1.2. Voltage Validation Process

1. Connect calibrator OUT terminals to the Joulescope IN terminals, observing polarity.
2. Connect a load to the Joulescope OUT terminals if recommended by your calibrator. Otherwise, leave the OUT terminals unconnected.
3. In the Joulescope UI, select **Voltage Range** to 15V.
4. Configure the calibrator to the target voltage.
5. Record the actual calibrator voltage, the calibrator's uncertainty at that voltage, and the Joulescope's measured voltage as displayed by the Joulescope UI.
6. Repeat 4 and 5 for each target voltage.
7. Repeat 2 through 6 for the 5V range.

The following image shows the calibration spreadsheet:

Voltage Measurement									
15V Range									
Target	Units	Applied	Applied Uncertainty	Expected Accuracy	Test Uncertainty Ratio	Lower Limit	As Measured	Upper Limit	
0.000	V			0.011	0.0	-0.011		0.011	
3.000	V			0.011	0.0	-0.011		0.011	
6.000	V			0.011	0.0	-0.011		0.011	
9.000	V			0.011	0.0	-0.011		0.011	
12.000	V			0.011	0.0	-0.011		0.011	
15.000	V			0.011	0.0	-0.011		0.011	
5V Range									
Target	Units	Applied	Applied Uncertainty	Expected Accuracy	Test Uncertainty Ratio	Lower Limit	As Measured	Upper Limit	
0.000	V			0.004	0.0	-0.004		0.004	
1.000	V			0.004	0.0	-0.004		0.004	
2.000	V			0.004	0.0	-0.004		0.004	
3.000	V			0.004	0.0	-0.004		0.004	
4.000	V			0.004	0.0	-0.004		0.004	
5.000	V			0.004	0.0	-0.004		0.004	

During the test process, you should fill in all light-blue cells with measurement data. All TUR values should be green. Yellow indicates that the test setup lacks sufficient accuracy. All “As Measured” values should be green. Red indicates that the Joulescope does not meet specifications.

16.1.3. Current Validation Process

The current calibration process can be performed using several methods. In all cases, the goal is to generate a current close to the target current. Strict accuracy on the generated current is not required. However, a reference measurement is required.

The general process is

1. Select the **Current Range** in the Joulescope UI
2. Configure the target current.
3. Record the applied current as measured by the reference, reference’s uncertainty at that current, and the Joulescope’s measured current as displayed by the Joulescope UI.
4. Repeat 2 and 3 for each target current
5. Repeat 1 through 4 for each current range.

Current Measurement									
10 A Range									
Target	Units	Applied	Applied Uncertainty	Expected Accuracy	Test Uncertainty Ratio	Lower Limit	As Measured	Upper Limit	
0.000	A			0.007	0.0	-0.007		0.007	
0.500	A			0.007	0.0	-0.007		0.007	
1.000	A			0.007	0.0	-0.007		0.007	
2.000	A			0.007	0.0	-0.007		0.007	
3.000	A			0.007	0.0	-0.007		0.007	
2 A Range									
Target	Units	Applied	Applied Uncertainty	Expected Accuracy	Test Uncertainty Ratio	Lower Limit	As Measured	Upper Limit	
0.0000	A			0.0015	0.0	-0.0015		0.0015	
0.5000	A			0.0015	0.0	-0.0015		0.0015	
1.0000	A			0.0015	0.0	-0.0015		0.0015	
1.5000	A			0.0015	0.0	-0.0015		0.0015	
2.0000	A			0.0015	0.0	-0.0015		0.0015	
180 mA Range									
Target	Units	Applied	Applied Uncertainty	Expected Accuracy	Test Uncertainty Ratio	Lower Limit	As Measured	Upper Limit	
0.00	mA			0.15	0.0	-0.15		0.15	
180.00	mA			0.15	0.0	-0.15		0.15	
18 mA Range									
Target	Units	Applied	Applied Uncertainty	Expected Accuracy	Test Uncertainty Ratio	Lower Limit	As Measured	Upper Limit	
0.000	mA			0.015	0.0	-0.015		0.015	
18.000	mA			0.015	0.0	-0.015		0.015	
1.8 mA Range									
Target	Units	Applied	Applied Uncertainty	Expected Accuracy	Test Uncertainty Ratio	Lower Limit	As Measured	Upper Limit	
0.0000	mA			0.0015	0.0	-0.0015		0.0015	
1.8000	mA			0.0015	0.0	-0.0015		0.0015	
180 µA Range									
Target	Units	Applied	Applied Uncertainty	Expected Accuracy	Test Uncertainty Ratio	Lower Limit	As Measured	Upper Limit	
0.00	µA			0.15	0.0	-0.15		0.15	
180.00	µA			0.15	0.0	-0.15		0.15	
18 µA Range									
Target	Units	Applied	Applied Uncertainty	Expected Accuracy	Test Uncertainty Ratio	Lower Limit	As Measured	Upper Limit	
0.000	µA			0.030	0.0	-0.030		0.030	
18.000	µA			0.030	0.0	-0.030		0.030	

Note that many of the test cases are for a 0.0 amp target current. In this setup, you can simplify the setup and leave the Joulescope instrument disconnected, or optionally short the Joulescope OUT terminals with a banana jumper wire.

Numerous valid test equipment methods exist to generate and accurately measure the target current. You may select a method that is appropriate for your equipment. The Joulescope has a very large current range, and you will need to accurately measure from 18 µA to 3 A. You may need to employ more than one method to cover the entire current range with a sufficient TUR. Possible methods include:

Method 1: Reference current source

If you have a reference current source, connect the current source to the Joulescope IN terminals, observing polarity. Connect the Joulescope OUT+ and OUT- terminals using a banana jack cable.

In step (2), directly configure the reference current source to generate the target current.

In step (3), read the applied current from the reference current source.

Method 2: Reference ammeter with current source

Connect an inaccurate current source to the Joulescope IN terminals, observing polarity. Connect the Joulescope OUT- terminal to the – terminal of the reference ammeter. Connect the Joulescope OUT+ terminal to the reference ammeter + terminal.

In step (2), configure the inaccurate current source to the target current.

In step (3), read the applied current from the reference ammeter.

Method 3: Reference ammeter with voltage source and variable load resistor

Connect an inaccurate voltage source to the Joulescope IN terminals, observing polarity. Connect the Joulescope OUT+ terminal to one terminal of a variable load resistor. Connect the other variable load resistor terminal to the reference ammeter + terminal. Connect the reference ammeter – terminal to the Joulescope OUT- terminal.

In step (2), select a target voltage and resistance combination to give the target current as computed using Ohm's law: $I = V / R$. Configure the load resistance, configure the voltage source, then enable the voltage output. Ensure that the voltage stays between 0 and 15V. We recommend adding a step 3.5 to disable the voltage output before changing the load resistance for the next target current.

In step (3), read the applied current from the reference ammeter.

17. Warranty

The Joulescope JS110 is warranted to be free from defects in materials and workmanship for a period of one year from the date of purchase. If your Joulescope becomes inoperative from such a defect within the warranty period, Jetperch will either repair or replace your unit, at Jetperch's discretion.

This warranty covers normal use. The warranty does not cover damage which occurs during shipment. The warranty does not cover damage from improper use, misuse, abuse, tampering, alteration, accident, software hacking, or recalibration other than by an authorized recalibration provider.

Jetperch LLC makes no other representations or warranties, express or implied, of any kind including, but not limited to, any implied warranty of merchantability or fitness for a particular purpose. Jetperch shall not be liable for loss of use of Joulescope. Jetperch will not be liable for any other incidental or consequential damages, expenses, or financial losses, nor will Jetperch be liable for claims of such damages.

To submit a warranty claim, contact support@jetperch.com. You will need to provide your name, address, phone number, and email. You will also need to provide proof of purchase, such as a purchase receipt, that contains the original date of sale.

18. Contact

To purchase this product, visit:

<https://www.joulescope.com>

To submit a warranty claim, first review the warranty section above. You can submit warranty claims to:

support@jetperch.com

If you have questions regarding operation of Joulescope, search the website at:

<https://www.joulescope.com/>

And visit the forum:

<https://forum.joulescope.com/>

For compliance information, see

<https://www.joulescope.com/compliance/JS110>

If you wish to contact Jetperch regarding the operation of your Joulescope, contact us through email at:

support@jetperch.com

Location

Jetperch LLC
3470 Olney - Laytonsville Rd.
Suite 104
Olney, MD 20832-1734
USA

19. Glossary

Accuracy

The average variation in the bias between measurements and truth. Good measurements are both accurate and precise.

Ammeter

A device that measures electrical current.

Burden Voltage

The voltage drop that occurs through the test equipment device. For shunt ammeters, the burden voltage includes the voltage across the shunt resistor, connectors, fuses, and any additional resistance in the device.

Current

The flow of electric charge per time from positive voltage to negative voltage, measured in amperes (A), often called amps. One amp is one coulomb of charge flowing per second. One coulomb is approximately 6.242×10^{18} electrons, but electric current is defined opposite to the electron flow.

Energy

The total power exerted over time, measured in joules (J). Energy is the time integral of power.

Insertion Loss

The loss in signal power due to a device in the signal path, most commonly used in reference to radio frequency (RF) or telecommunications. See **Burden Voltage**.

Multimeter

A multifunction device that usually incorporates a voltmeter and shunt ammeter, at a minimum. A standard multimeter supports only one measurement quantity at a time.

Ohm's Law

The equation that relates voltage, current and resistance: $V = I * R$

Oscilloscope

A device that graphically displays a one or more signals, usually voltages, varying over time as a two-dimensional plot with time on the x-axis and the signal on the y-axis.

Power

The time-rate of doing work, measured in watts (W). Power is voltage multiplied by current.

Precision

The amount of variation between measurements of the same value relative to each other. Good measurements are both accurate and precise.

Resistance

The quantity of opposition to the flow of electric current.

Shunt Ammeter

An ammeter that measures the voltage across a resistor, and then uses Ohm's Law to compute current.

Shunt Resistor

The resistor used by “Shunt Ammeters” to detect current using Ohm’s Law: $I = V / R$. Given a known R and a measured V, the ammeter computes I.

Universal Serial Bus (USB)

The now ubiquitous standard for connecting computers and peripherals. Joulescope connects to the host computer using USB 2.0 high-speed.

Voltage

The electric potential difference, measured in volts (V).

Voltmeter

A device that measures electrical voltage.

20. User's guide information

This section contains information regarding this document. See the other sections of this document for information regarding the Joulescope product.

20.1. Copyright notice

© 2019-2020 Jetperch LLC

All material in this User's Guide, including the text, images, design, and logos, are owned by Jetperch LLC, either through copyright or trademark, unless otherwise indicated. No part of this User's Guide may be reproduced in any form or by any means without prior written consent from Jetperch LLC as governed by the United States and international copyright laws.

20.2. Publisher

Jetperch LLC
3470 Olney – Laytonsville Rd
Suite 104
Olney, MD 20832-1734
USA

20.3. Warranty

The Joulescope JS110 User's Guide is provided AS-IS with no other representations or warranties, expressed or implied, of any kind including, but not limited to, any implied warranty of merchantability of fitness for a particular purpose. Jetperch LLC does make reasonable efforts to present accurate and reliable information in this Joulescope JS110 User's Guide.

The information in this User's Guide is subject to change. The most up-to-date version of this User's Guide can be retrieved from <http://www.joulescope.com/>.

20.4. Change log

Revision	Date	Description
1.0	2020 June 27	Removed “Preliminary” watermark. Removed “Why is this document preliminary?” section. Added calibration validation procedure. Added heading numbers Improved GPIO description. Added images using UI 0.8.16 and JS110 production hardware. Add “Meet Your Joulescope” section. Expanded “Theory of Operation” section. Grammar improvements.
0.6	2019 Oct 16	Added GPO current and power specifications. Added GPI information. Clarified annotations, markers and cursors. Increased over-range settling time from 3 μ s to 5 μ s. Updated directions for UI 0.6.
0.5	2019 Jun 20	Added table of contents to table of contents. Updated GPI/O section for production rev H. Added statement about software support. Fixed typos and grammar. Updated compliance information. Updated for 0.4.x software. Updated “Why is the document preliminary”.
0.4	2019 Mar 11	Updated electrical isolation section for rev E
0.3	2019 Mar 1	Added electrical isolation section Added GPI/GPO Added Typical Behavior section with step response Fixed SI unit capitalization: See the definitive SI Brochure
0.2	2019 Feb 12	First public release
0.1	2018 Dec 17	Initial draft