

HIGHLIGHTS

FEATURES

- Altech DIN Rails comply with DIN EN60715, EN50022, EN50035, EN50045 standards
- Easy mounting of terminal blocks, power supplies and other control components and devices into panel
- Space saving
- Reduces labor
- 35mm, 32mm and 15mm versions
- 1m and 2m standard length
- Custom length available
- Perforated, unperforated

MATERIAL

- Zinc-plated steel
 - 35x7.5mm
 - 35x15mm
 - 32mm
 - 15mm
- Aluminum
 - 35x7.5mm
- Stainless Steel (Type AISI 304)
 - 35x7.5mm

DIN35 x 7.5



35 mm x
7.5 mm deep

Zinc Plated Steel

| Type | Cat. No. | Length | Std. Pk. |
|--------------|------------|--------|----------|
| Perforated | 2511120 | 2m | 20 |
| | 2511120/1M | 1m | 40 |
| Unperforated | 2511110 | 2m | 20 |
| | 2511110/1M | 1m | 40 |

Stainless Steel

| Type | Cat. No. | Length | Std. Pk. |
|--------------|------------|--------|----------|
| Perforated | 2511125 | 2m | 20 |
| | 2511125/1M | 1m | 40 |
| Unperforated | 2511115 | 2m | 20 |
| | 2511115/1M | 1m | 40 |

Aluminum

| Type | Cat. No. | Length | Std. Pk. |
|--------------|------------|--------|----------|
| Perforated | 2511121 | 2m | 20 |
| | 2511121/1M | 1m | 40 |
| Unperforated | 2511111 | 2m | 20 |
| | 2511111/1M | 1m | 40 |

DIN35 x 15



35 mm x
15 mm deep

Zinc Plated Steel

| Type | Cat. No. | Length | Std. Pk. |
|--------------|---------------|--------|----------|
| Perforated | CA701-15/S-2M | 2m | 20 |
| | CA701-15/S | 1m | 40 |
| Unperforated | CA701-15-2M | 2m | 20 |
| | CA701-15 | 1m | 40 |

Dimensions

Perforated Steel and Stainless

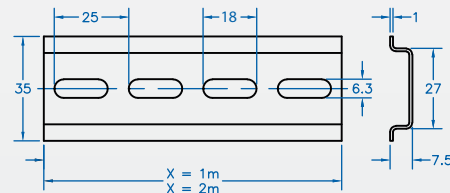

Perforated Steel

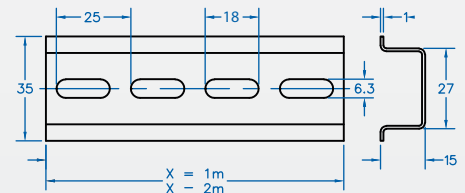

Perforated Aluminum

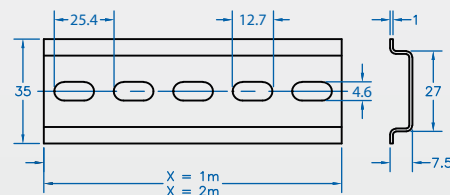

Unperforated Steel

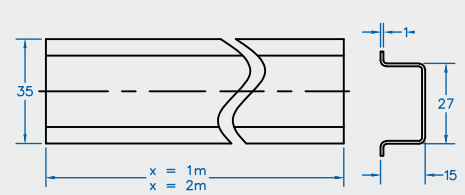

Unperforated

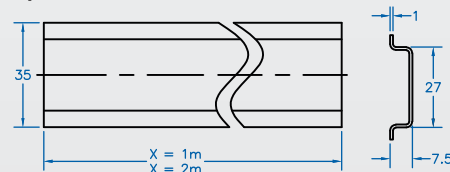

DIN RAIL

DIN32



32 mm x
15 mm deep

Zinc Plated Steel

| Type | Cat. No. | Length | Std. Pk. |
|--------------|------------|--------|----------|
| Perforated | 2511160 | 2m | 10 |
| | 2511160/1M | 1m | 20 |
| Unperforated | 2511150 | 2m | 10 |
| | 2511150/1M | 1m | 20 |

DIN15



15 mm x
5.5 mm deep

Zinc Plated Steel

| Type | Cat. No. | Length | Std. Pk. |
|------------|----------|--------|----------|
| Perforated | CA601/S | 2m | 20 |

Dimensions

Perforated Steel

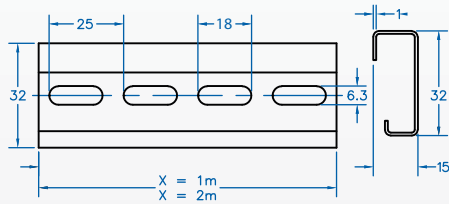

Perforated Steel

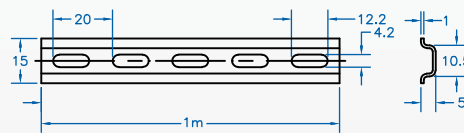

Unperforated Steel

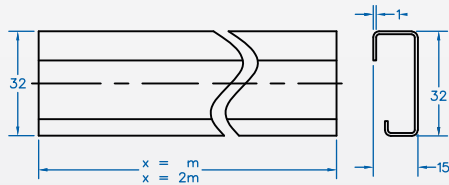

SUPPORT BRACKETS

CA603

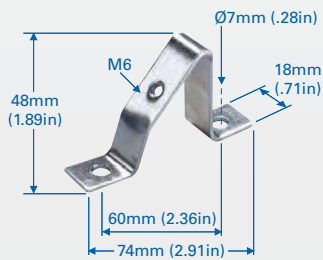

| Cat. No. | Std. Pk. |
|----------|----------|
| CA603 | 25 |

TSTW

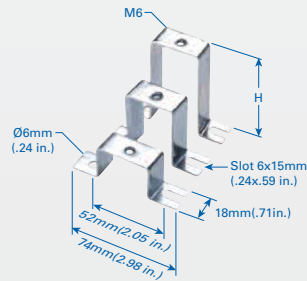

| Cat. No. | Height | Std. Pk. |
|----------|--------|----------|
| CA703 | 1 in. | 25 |
| CA803 | 2 in. | 25 |
| CA903 | 3 in. | 25 |

UNIVERSAL DIN CLIPS

D35CLIP



| Cat. No. | Mounting Hole | Std. Pk. |
|------------|---------------|----------|
| D35CLIP-M4 | M4 | 100 |
| D35CLIP-M5 | M5 | 100 |

HIGHLIGHTS

SUPPORT BRACKETS

- Elevate DIN Rail away from panel
- Easier mounting of components
- Suitable for all mounting rails
- Increase wiring access
- 45° version for improved visibility
- Straight brackets available in 3 heights:
 - 1"
 - 2"
 - 3"

MOUNTING

- Brackets mount with 2 screws to any panel or flat surface
- Tapped center hole for DIN Rail mounting

MATERIAL

- Zinc-plated yellow chromated Steel

UNIVERSAL DIN CLIPS

- Clips on to any 35mm/32mm DIN Rail
- Flexible mounting solution
- Mount any component on 32mm/35mm DIN Rail
- Various mounting hole solutions
- Material: zinc-plated steel, Polyamide 66

SPACER

- Increases creepage and clearance distance between terminal blocks
- Segregate different groups of terminal blocks

WARNING LABELS

- Mounted on top of terminal block for visual identification
- Make entire terminal block assembly shock-proof

SUPPORT BRACKETS



| Cat. No. | Std. Pk. |
|----------|----------|
| CA603 | 25 |

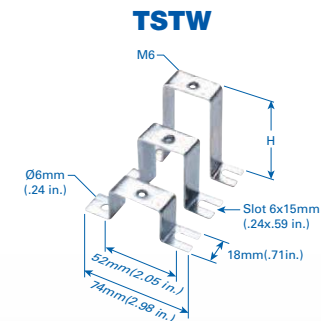

| Cat. No. | Height | Std. Pk. |
|----------|--------|----------|
| CA703 | 1 in. | 25 |
| CA803 | 2 in. | 25 |
| CA903 | 3 in. | 25 |

UNIVERSAL DIN CLIPS

D35CLIP

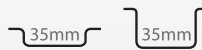

| Cat. No. | Mounting Hole | Std. Pk. |
|------------|---------------|----------|
| D35CLIP-M4 | M4 | 100 |
| D35CLIP-M5 | M5 | 100 |

CMTB35

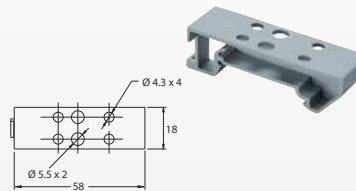

| Cat. No. | Mounting Hole | Std. Pk. |
|----------|---------------|----------|
| CMTB35 | 2x4.4 mm | 50 |
| | 2x5.5 mm | |

CA902

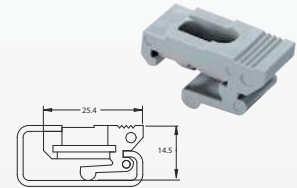

| Cat. No. | Std. Pk. |
|----------|----------|
| CA902 | 100 |

SPACER

CASP



| Cat. No. | Dimensions | Std. Pk. |
|----------|----------------|----------|
| CASP | 29 x 43 x 8 mm | 50 |

CDL4U SPACER



| Cat. No. | Dimensions | Std. Pk. |
|----------|------------------|----------|
| CDL4USP | 54 x 55.5 x 6 mm | 50 |

WARNING LABELS

| Cat. No. | Terminal Blocks | Pack | Std. Pk. Strips | Tags |
|----------|---------------------------------------|------|-----------------|------|
| WLX2.5 | CX2.5 Series, CXDL2.5, CXK2.5, CXM2.5 | 1 | 20 | 100 |
| WLX4 | CX4 Series, CXF Series, CXK4 | 1 | 20 | 100 |
| WLX6 | CX6 Series, CXDB Series | 1 | 20 | 100 |
| WLX10 | CX10 Series | 1 | 20 | 100 |
| SWL4 | CTS4U-N, CDB4, CMDB4 | 1 | 20 | 100 |
| SWL10 | CTS6U, CDB6U, CMDB6 | 1 | 20 | 100 |



END STOPS

Selection Table

| DIN Rail Type | CA102 | CA202 | CA702 | CA802 | CA103 | CA602 | CA302 | CA402 | CA502 |
|-------------------|-------|-------|-------|-------|-------|-------|-------|-------|-------|
| 35x7.5mm DIN Rail | ✓ | ✓ | ✓ | ✓ | ✓ | | ✓ | | |
| 35x15mm DIN Rail | ✓ | ✓ | ✓ | ✓ | ✓ | | | ✓ | |
| 32mm DIN Rail | ✓ | | ✓ | | | | | | ✓ |
| 15mm DIN Rail | | | | | | ✓ | | | |

HIGHLIGHTS

MOUNTING PINS

- End Stops prevent Terminal Blocks and other DIN Rail components from moving on the rail
- Versions for
 - 35x7.5mm Rail
 - 35x15mm Rail
 - 32mm Rail
 - 15mm Rail
- Heavy Duty End stop **CA102, CA202**
- Screwless End Stop **CA103** (snap on)
- Material:
 - Polyamide
 - Steel

POLYAMIDE 66

CA702



| Cat. No. | Dimensions | Std. Pk. |
|----------|---------------|----------|
| CA702 | 34 x 44 x 9mm | 50 |

CA802

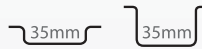

| Cat. No. | Dimensions | Std. Pk. |
|----------|---------------|----------|
| CA802 | 32 x 45 x 8mm | 50 |

CA202



Heavy Duty End Stop



| Cat. No. | Dimensions | Std. Pk. |
|----------|-------------------|----------|
| CA202 | 44.5 x 50 x 9.5mm | 50 |

CA102



| Cat. No. | Dimensions | Std. Pk. |
|----------|---------------|----------|
| CA102 | 46 x 50 x 9mm | 50 |

CA103

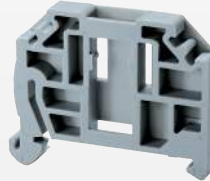

Screwless Snap-On

| Cat. No. | Dimensions | Std. Pk. |
|----------|---------------|----------|
| CA103 | 41 x 35 x 6mm | 50 |

CA602



| Cat. No. | Dimensions | Std. Pk. |
|----------|---------------|----------|
| CA602 | 20 x 28 x 8mm | 50 |

STEEL

CA302

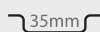

| Cat. No. | Dimensions | Std. Pk. |
|----------|------------------|----------|
| CA302 | 27 x 39.5 x 16mm | 50 |

CA402



| Cat. No. | Dimensions | Std. Pk. |
|----------|------------------|----------|
| CA402 | 27 x 39.5 x 16mm | 50 |

CA502



| Cat. No. | Dimensions | Std. Pk. |
|----------|--------------------|----------|
| CA502 | 25 x 22.5 x 11.5mm | 50 |

HIGHLIGHTS

FEATURES

- Group identification
- Holders fit standard **MT8** marking tags
- GMH6, GMH7 mounted directly on DIN Rail
- GMH1, GMH2, GMH3, GMH4, GMH5, GMH8 mounted on End Stops
- MT1G, MT2G, can be used with all these holders or can be directly mounted on all end stops
- Material: Polyamide 66

DIN RAIL MOUNT

GMH6



| Cat. No. | Dimensions | Std. Pk. |
|----------|---------------------|----------|
| GMH6 | 46.5 x 44.5 x 9.5mm | 50 |

GMH7



| Cat. No. | Dimensions | Std. Pk. |
|----------|----------------------|----------|
| GMH7 | 46.5 x 44.5 x 19.5mm | 50 |

MOUNT ON END STOP

GMH1

Suitable for CA602



| Cat. No. | Dimensions | Std. Pk. |
|----------|-------------------|----------|
| GMH1 | 15.8 x 14.6 x 8mm | 100 |

GMH4

Suitable for CA802



| Cat. No. | Dimensions | Std. Pk. |
|----------|-----------------|----------|
| GMH4 | 16.2 x 14 x 8mm | 100 |

GMH5

Suitable for CA702



| Cat. No. | Dimensions | Std. Pk. |
|----------|-----------------|----------|
| GMH5 | 13.7 x 14 x 8mm | 100 |

GMH2 / GMH3

Suitable for CA702 (GMH2)
CA802 (GMH3)

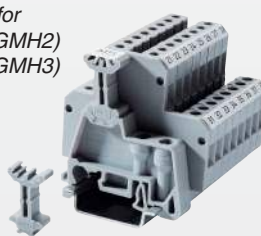

| Cat. No. | Dimensions | Std. Pk. |
|----------|-----------------|----------|
| GMH2 | 23.2 x 14 x 8mm | 100 |
| GMH3 | 23 x 14 x 8mm | 100 |

GMH8 / GMH8N

Suitable for CA103



| Cat. No. | Dimensions | Std. Pk. |
|----------|----------------------|----------|
| GMH8 | 44.65 x 31.10 x 10mm | 100 |
| GMH8N | 44.65 x 31.10 x 6mm | 100 |

MTG1 / MTG2

Mountable on all End Clamps

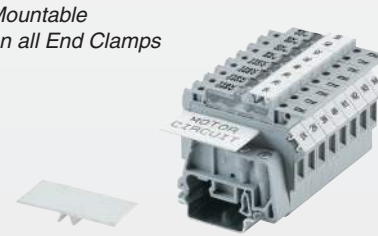

| Cat. No. | Dimensions | Std. Pk. |
|----------|-------------------|----------|
| MTG1 | 4.3 x 34 x 17.8mm | 50 |
| MTG2 | 4.3 x 34 x 8mm | 50 |

TM5

Suitable for CXDL Series



| Cat. No. | Dimensions | Std. Pk. |
|----------|---------------|----------|
| TM5 | 38 x 17 x 5mm | 50 |

MARKING TAGS



- Cost Effective MT marking system for quick and accurate identification
- Push-On Tags fit all Altech DIN Rail mount terminal blocks
- Inserted individually or as strips of 10
- Quick and easy marking
- Blank Marking Tags for customer marking
- Order with horizontal/ vertical imprint
- Standard imprints with consecutive or identical numbers/ characters
- Custom imprint with short lead time
- Supplied in packs of 100 tags/ 10 strips

BLANK MARKING TAGS

| Cat No./ Type | Standard Packs | | | Dimensions | |
|------------------------|----------------|--------|------|------------|--------|
| | Pack | Strips | Tags | H | W |
| MT2 | 1 | 10 | 100 | 4.9mm | 5.8mm |
| MT3 | 1 | 20 | 100 | 5.0mm | 10.0mm |
| MT4 | 1 | 10 | 100 | 5.0mm | 4.8mm |
| MT5 | 1 | 10 | 100 | 9.5mm | 4.5mm |
| MT6 | 1 | 10 | 100 | 9.5mm | 5.6mm |
| MT8 | 1 | 10 | 100 | 10.5mm | 7.5mm |
| MT9 | 1 | 10 | 100 | 10.3mm | 8.7mm |
| MT10 | 1 | 20 | 100 | 10.4mm | 9.5mm |
| MT12 | 1 | 20 | 100 | 10.4mm | 11.4mm |
| MT16 | 1 | 20 | 100 | 10.5mm | 15.4mm |
| MT2G | 1 | 10 | 100 | 5.0mm | 5.0mm |
| MT2B4 | 1 | 10 | 100 | 5.8mm | 9.1mm |
| Continuous Tags | | | | | |
| MT6F | 1 | 10 | 10 | 9.5mm | 60.0mm |
| MT9F | 1 | 10 | 10 | 10.3mm | 90.0mm |

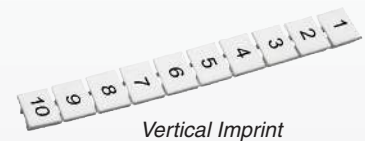
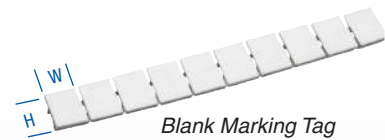

HOW TO ORDER IMPRINTED MARKING TAGS

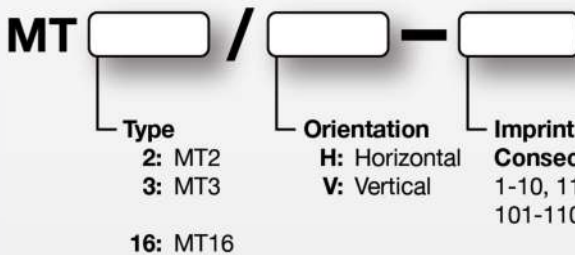

IMPRINT EXAMPLES FOR MT6

| HORIZONTAL | | | | VERTICAL | | | |
|------------|---------------|---------------|---------------|----------|---------------|---------------|---------------|
| Imprint | Cat. No. | Imprint | Cat. No. | Imprint | Cat. No. | Imprint | Cat. No. |
| 1 | MT6/H-1 | 131-140 | MT6/H-131-140 | 1 | MT6/V-1 | 131-140 | MT6/V-131-140 |
| 2 | MT6/H-2 | 141-150 | MT6/H-141-150 | 2 | MT6/V-2 | 141-150 | MT6/V-141-150 |
| 3 | MT6/H-3 | 151-160 | MT6/H-151-160 | 3 | MT6/V-3 | 151-160 | MT6/V-151-160 |
| 4 | MT6/H-4 | 161-170 | MT6/H-161-170 | 4 | MT6/V-4 | 161-170 | MT6/V-161-170 |
| 5 | MT6/H-5 | 171-180 | MT6/H-171-180 | 5 | MT6/V-5 | 171-180 | MT6/V-171-180 |
| 6 | MT6/H-6 | 181-190 | MT6/H-181-190 | 6 | MT6/V-6 | 181-190 | MT6/V-181-190 |
| 7 | MT6/H-7 | 191-200 | MT6/H-191-200 | 7 | MT6/V-7 | 191-200 | MT6/V-191-200 |
| 8 | MT6/H-8 | 1-100 | MT6/H-1-100 | 8 | MT6/V-8 | 1-100 | MT6/V-1-100 |
| 9 | MT6/H-9 | 1-50 | MT6/H-1-50 | 9 | MT6/V-9 | 1-50 | MT6/V-1-50 |
| 10 | MT6/H-10 | A | MT6/H-A | 10 | MT6/V-10 | A | MT6/V-A |
| 1-10 | MT6/H-1-10 | B | MT6/H-B | 1-10 | MT6/V-1-10 | B | MT6/V-B |
| 11-20 | MT6/H-11-20 | C | MT6/H-C | 11-20 | MT6/V-11-20 | C | MT6/V-C |
| 21-30 | MT6/H-21-30 | L1 | MT6/H-L1 | 21-30 | MT6/V-21-30 | L1 | MT6/V-L1 |
| 31-40 | MT6/H-31-40 | L2 | MT6/H-L2 | 31-40 | MT6/V-31-40 | L2 | MT6/V-L2 |
| 41-50 | MT6/H-41-50 | L3 | MT6/H-L3 | 41-50 | MT6/V-41-50 | L3 | MT6/V-L3 |
| 51-60 | MT6/H-51-60 | N | MT6/H-N | 51-60 | MT6/V-51-60 | N | MT6/V-N |
| 61-70 | MT6/H-61-70 | R | MT6/H-R | 61-70 | MT6/V-61-70 | R | MT6/V-R |
| 71-80 | MT6/H-71-80 | S | MT6/H-S | 71-80 | MT6/V-71-80 | S | MT6/V-S |
| 81-90 | MT6/H-81-90 | X | MT6/H-X | 81-90 | MT6/V-81-90 | X | MT6/V-X |
| 91-100 | MT6/H-91-100 | Y | MT6/H-Y | 91-100 | MT6/V-91-100 | Y | MT6/V-Y |
| 101-110 | MT6/H-101-110 | Z | MT6/H-Z | 101-110 | MT6/V-101-110 | Z | MT6/V-Z |
| 111-120 | MT6/H-111-120 | Ground Symbol | MT6/H-GRND | 111-120 | MT6/V-111-120 | Ground Symbol | MT6/V-GRND |
| 121-130 | MT6/H-121-130 | | | 121-130 | MT6/V-121-130 | | |

FREE Altech® PLOTTER

with **\$5000**
in annual
Terminal Block
purchases

FREE:
Altech®
CMPS Plotter Package
Cat. No. 34130020

**Comes with everything needed
to begin printing MT5,6,8,10,12
and 15 tags.**

- CMPS plotter
- Size: 17"x18"x4.9"
- CMPS software with cable
- 1 triple fixture for MT5, 6, 8, 10, 12 & 15
- 2 disposable pens



**Contact your local
Altech Representative
for the details.**

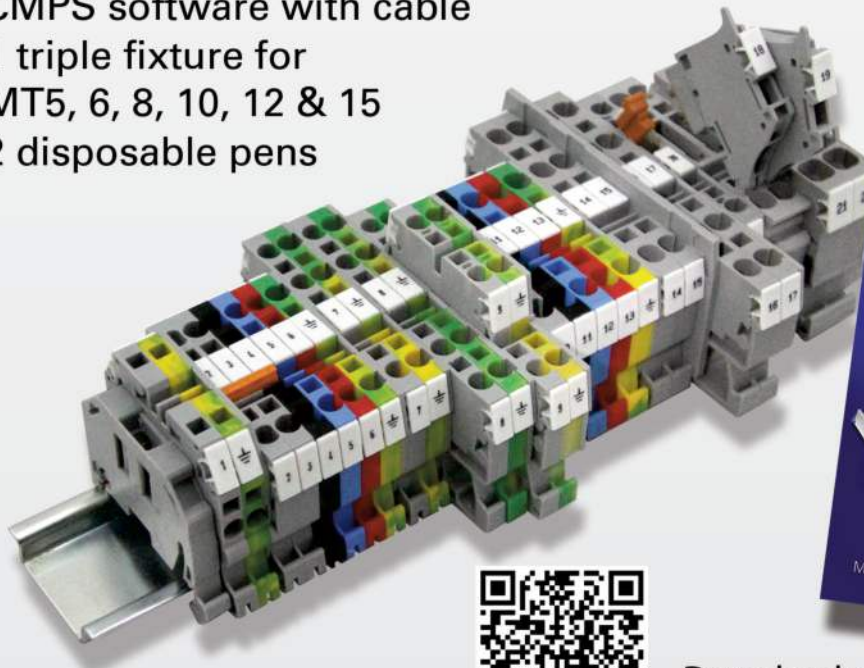

Download a
Marking System catalog today.

MARKING SYSTEMS

PLOTTERS

The Altech VP Series base unit is an auxiliary plotter that has to be connected to a PC via a USB connection. It is a high speed plotting device and enables plotting of different markers in one setting. The base unit is controlled through a PC with the help of Vario Sign software (sold separately). Manual available in English and Spanish.

The special design of the VP Series enables it to hold different markers from various manufacturers at the same time. It is also possible to write on relatively large markers with a maximum height of 10.5 mm.

PLOTTER VP 600 BASIC

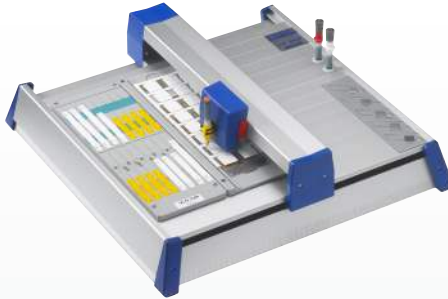

Ordering Information

Cat No. 34000082

- Professionally marking of connectors, wires, cables, equipment, cable ties, shrink tubing, labels and signs of different sizes and materials, as well as customer-specific items.
- Manual insertion of plotter pen
- Auto calibration
- Universal Power Supply 100-240V AC
- Control language HPGL
- Universal marking software (VarioSign) sold separately
- Marking area 273 x 305 mm
- Size: 18.5 x 18.9 x 6.1 in. (470 x 480 x 155 mm)
- Weight: 13.9 lbs.

PLOTTER VP 600 A3

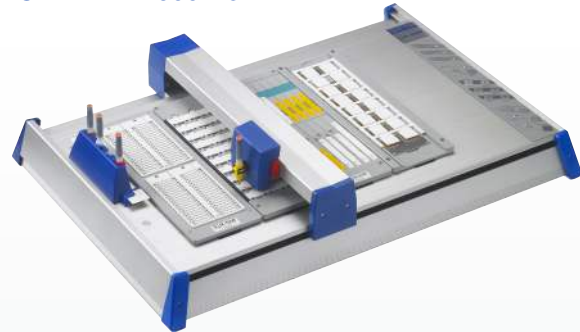

Ordering Information

Cat No. 34000080

- Basic features of plotter VP 600 Basic plus:
- Integrated and automated pen station. Holds 4 different pens at the same time, for fast and frequently changing applications.
- Built-in pen priming function
- Automatic recognition system for marking fixture / plates ensures faster and easier handling of frequently changing marking applications.
- Wide marking area 422 x 305 mm
- Size: 27.2 x 18.9 x 6.1 in. (690 x 480 x 155 mm)
- Weight: 18.3 lbs.

ACCESSORIES

PLOTTER PENS



| Cat. No. | Description | Tip Size |
|----------|----------------------------------|----------|
| 35003018 | Etching Plotter Pen (red) | 0.18 mm |
| 35003025 | Etching Plotter Pen (white) | 0.25 mm |
| 35003035 | Etching Plotter Pen (yellow) | 0.35 mm |
| 35003118 | Non-Etching Plotter Pen (red) | 0.18 mm |
| 35003125 | Non-Etching Plotter Pen (white) | 0.25 mm |
| 35003135 | Non-Etching Plotter Pen (yellow) | 0.35 mm |

ALTECH FIXTURES



| Cat. No. | Description |
|----------|---------------------------------|
| 34902191 | MT2G |
| 34902081 | MT2, MT3, MT4, MT2B4 |
| 34902001 | MT5, MT6, MT8, MT10, MT12, MT16 |
| 34902057 | MT9 |
| 34902080 | MTG1, MTG2 |

* Fixtures for other Terminal Block Manufacturers are available, please contact Altech for additional information.

SOFTWARE



| Cat. No. | Description |
|----------|--------------------|
| 34000022 | Variosign Software |