



SPECIFICATIONS

| Model | Stroke mm | Max Absorption Energy J(kgf·m) | Max Equivalent Mass kg (kgf) |
|------------|-----------|--------------------------------|------------------------------|
| FK-3650L-S | 50 | 392(40) | 3,137(3,137) |

| Max Drag N (kgf) | Max. Absorption Energy per min. J/min(kgf·m/min) | Extension Force N(kgf) | Mass g |
|------------------|--|------------------------|--------|
| 2,352 (240) | 21,110(2,154) | 68.6(7.0) or lower | 1177 |

COMMON SPECIFICATIONS

| | | |
|-----------------------|-----------|-------|
| Range of Impact Rate | m/s | 0.3~1 |
| Maximum Cycle Rate | cycle/min | 30 |
| Operating Temperature | C° | -5~70 |

CHARACTERISTICS

- With a fixed, specially-designed orifice structure, an optimal impact absorption can be achieved even under variable operating conditions.
- The main unit can also be used as a stopper. (No external stopper required, except for FK-3625A)
- Three different types are available to accommodate various speeds. For low-speed: L, for medium-speed: M, for highspeed: H.
- Urethane cap specification is also available.
- Two or more of each product can be used in parallel.
- This product can also be custom-designed for optimal impact absorption.

PRECAUTIONS FOR USE

- Do not use this product without carefully reading the attached owner's manual.
- Do not turn the oil inlet screw located at the bottom of the main unit.
- Ensure that sufficient mounting strength is secured for this product. (As a guideline, it should be 2 to 3 times the maximum drag listed in the catalogue.)
- Do not use this product in a vacuum or a location where it may come in contact with oil.
- Ensure that an eccentric load is not applied to the soft absorber. (Allowable eccentric angle: $\pm 2.5^\circ$)
- We recommend that you use it with an external stopper(OP-020**).
- Urethane caps are consumable goods that need to be replaced with new ones if necessary.

OPTIONAL PARTS

Eccentric angle adaptor OP-010UB

- When attaching the eccentric angle adaptor, screw it into the main unit until the cap for eccentric angle and the piston rod form a tight connection. While maintaining this position, fasten the main unit's nut until secured.
 - * If the eccentric angle adaptor is secured without establishing a tight fit, a sufficient stroke cannot be obtained. Furthermore, if the eccentric angle adaptor is further screwed in, after it has formed a tight connection, and then secured in place, the cap for eccentric angle cannot be pushed all the way to the stroke end.
- The inclined adapter is not available for models with soft absorber cap (-C) and urethane cap (-R)

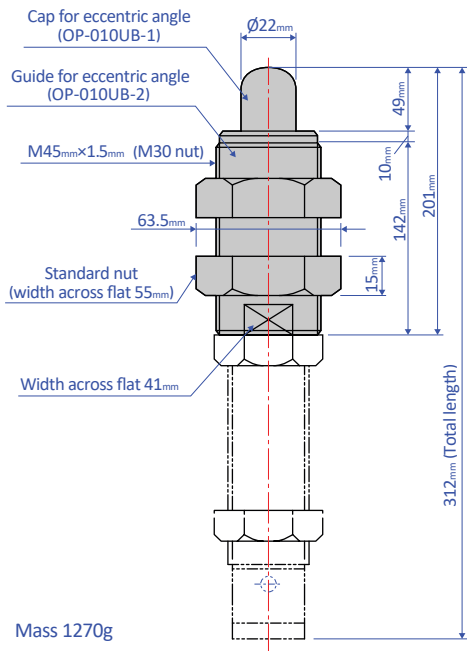

Mass 1270g

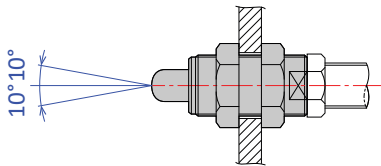

Stopper nut OP-020UB

- Adjust so that it stops 1 mm before the stroke end, and fasten with the main unit's nut until secured.

OP-020UB-S
(without cap)

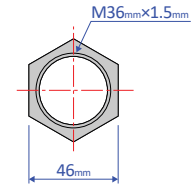
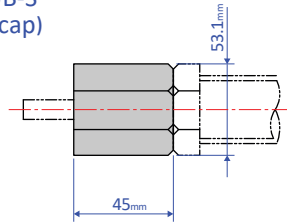

Mass 291g

OP-020UB-C
(with cap)

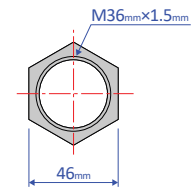
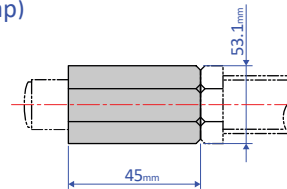

Mass 422g

Note: When attaching, make sure that the side without a bearing chamfer is the impact surface.

Flange OP-OP-040UB

- This is a mounting fixture for soft absorbers

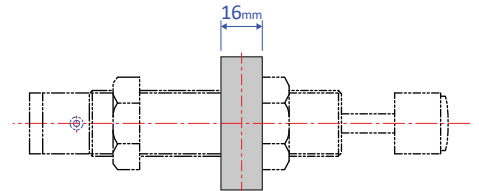
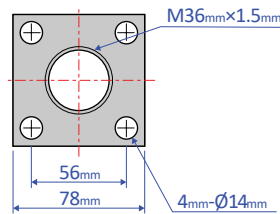

Mass 566g

Urethane cap OP-090M36A

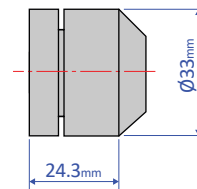

Standard nuts are sold separately as well - M36 Nut